

MBL/WHOJ



0 0301 0014791 4

A TEXT-BOOK OF ZOOLOGY



MACMILLAN AND CO., LIMITED
LONDON . BOMBAY . CALCUTTA . MADRAS
MELBOURNE

THE MACMILLAN COMPANY
NEW YORK . BOSTON . CHICAGO
DALLAS . SAN FRANCISCO

THE MACMILLAN CO. OF CANADA, LTD.
TORONTO

A TEXT-BOOK OF ZOOLOGY

BY THE LATE

T. JEFFERY PARKER, D.Sc., F.R.S.

PROFESSOR OF BIOLOGY IN THE UNIVERSITY OF OTAGO, DUNEDIN, N.Z.

AND

WILLIAM A. HASWELL, M.A., D.Sc., F.R.S.

EMERITUS PROFESSOR OF BIOLOGY IN THE UNIVERSITY OF SYDNEY, N.S.W.

IN TWO VOLUMES

VOL. I

WITH ILLUSTRATIONS

MACMILLAN AND CO., LIMITED
ST. MARTIN'S STREET, LONDON

1921

COPYRIGHT

First Edition, 1881.
Second Edition, 1889.
Third Edition, 1928.

PREFACE TO THE FIRST EDITION

IN spite of its bulk, the present work is strictly adapted to the needs of the beginner. The mode of treatment of the subject is such that no previous knowledge of Zoology is assumed, and students of the first and second years should have no more difficulty in following the accounts of the various groups than is incidental to the first study of a complex and unfamiliar subject.

There can be little doubt that the study of Zoology is most profitably as well as most pleasantly begun in the field and by the sea-shore, in the Zoological Garden and the Aquarium. In a very real sense it is true that the best zoologist is he who knows the most animals, and there can certainly be no better foundation for a strict and scientific study of the subject than a familiarity with the general appearance and habits of the common members of the principal animal classes. But Zoology as a branch of academical study can hardly be pursued on the broad lines of general natural history, and must be content to lose a little in breadth of view—at least in its earlier stages—while insisting upon accurate observation, comparison, and induction, within the limited field of Laboratory and Museum work.

A not uncommon method of expounding the science of Zoology is to begin the study of a given group by a definition, the very terms of which it is impossible that the student should understand; then to take a general survey of the group, illustrated by casual references to animals and to structures of which it is highly unlikely he has ever heard; and, finally, to descend to a survey of the more important forms included in the group. It will probably be generally agreed that, from the teacher's point of view, this method begins at the wrong end, and is hardly more rational than it would be to deliver a course on the general characteristics of

English Literature, suitably illustrated by "elegant extracts," to a class of students who had never read a single English poet or essayist.

There can be no question as to the vast improvement effected in zoological teaching by the practice of preceding the study of a given group as a whole by the accurate examination of a suitable member of it. With the clear mental image of a particular animal, in the totality of its organisation, the comparison of the parts and organs of other animals of like build becomes a profitable study, and the danger of the comparative method—that the student may learn a great deal of the systems of organs in a group without getting a clear conception of a single animal belonging to it—is much diminished.

The method of "types" has, however, its own dangers. Students are, in their way, great generalisers, and, unless carefully looked after, are quite sure to take the type for the class, and to consider all Arthropods but crayfishes and cockroaches, and all Molluscs but mussels and snails, as non-typical. For this reason a course of Zoology which confines itself entirely or largely to "types," or, as we prefer to call them,¹ examples, is certain to be a singularly narrow and barren affair, and to leave the student with the vaguest and most erroneous ideas of the animal kingdom as a whole. This is especially the case when the number of examples is small, each of the Phyla being represented by only one or two forms.

In our opinion every group which cannot readily and intelligibly be described in terms of some other group should be represented, in an elementary course of Zoology, by an example. We have, therefore, in the majority of cases, described, in some detail, an example of every important class, and, in cases where the diversity of organisation is very great—as in Crustacea and Fishes—two or more examples are taken. The student is thus furnished with a brief account of at least one member—usually readily accessible—of all the principal groups of animals.

By the time the example has been studied, a definition of the class and of its orders will convey some idea to the mind, and will serve to show which of the characters already met with are of

¹ Following a suggestion for which we are indebted to Dr. Alexander Hill, Master of Downing College, Cambridge.

distinctive importance, and which special to the example itself. In order to bring out this point more clearly, to furnish a connection between the account of the example and that of the class as a whole, and to give some idea of the meaning of specific, generic, and family characters, we have introduced, after the classification, a paragraph giving the systematic position of the example, sometimes in more, sometimes in less detail.

Following the table of classification with its brief definitions comes the general account of the group. This is usually treated according to the comparative method, the leading modifications of the various parts and organs being described *seriatim*. In a few cases this plan has been abandoned and the class described order by order, but this is done only when the deviations from the type are so considerable as to lead us to think the comparative method unsuitable for beginners. On the other hand, when all the classes of the phylum present a very uniform type of structure, the phylum is studied comparatively as a whole. The description of each group usually ends with some account of its ethology and distribution, and with a discussion of its affinities and of the mutual relationships of its various subdivisions.

We have done our best to make the space devoted to each group proportional to its complexity and range of variation, and to subdue the natural tendency to devote most attention to the more recently investigated classes, or to those in which we ourselves happen to be especially interested. A few lesser groups have been put into small type, partly to economise space, partly because they seem to us to be of minor importance to the beginner.

Following out the plan of deferring the discussion of general questions until the facts with which they are connected have been brought forward, we have placed the sections on Distribution, on the Philosophy of Zoology, and on the History of Zoology at the end of the book. We have, however, placed a general account of the structure and physiology of animals immediately after the Introduction, and one on the Craniate Vertebrata before the description of the classes of that division, but it will be obvious that these deviations from the strictly inductive method were inevitable in order to avoid much needless repetition.

After a good deal of consideration we have decided to omit all references to the literature of the subject in the body of the work.

Anything like consistent historical treatment would be out of place in an elementary book; and the introduction of casual references to particular discoveries, while they might interest the more advanced reader by giving a kind of personal colouring to the subject, could hardly fail, from their necessarily limited character, to be misleading to the beginner, and to increase rather than diminish his difficulties. We have, therefore, postponed all reference to the history of the science to the concluding Section, in which the main lines of progress are set forth, and have given, as an Appendix, a guide to the modern literature of Zoology. The latter is intended merely to indicate the next step to be taken by the student who wishes to acquire something more than a mere text-book knowledge.¹

The various Sections have been written by the authors in fairly equal proportions, but the work of each has been carefully read and criticised by the other, and no disputed point has been allowed to stand without thorough discussion. We are therefore jointly and severally responsible for the whole work.

A very large proportion of the figures have been specially drawn and engraved for the book. Those in which no source is named are from our own drawings, with the exception of Figs. 571, 572, 1017, 1018, 1019, 1022, 1059, 1063, and 1071, for which we are indebted to Mrs. W. A. Haswell. Figs. 1002 *bis*, 1005 *bis*, are from photographs kindly taken for us by Mr. A. Hamilton.² Many blocks have been borrowed from well-known works, to the authors and publishers of which we beg to return our sincere acknowledgments. All the new figures have been drawn by Mr. M. P. Parker.

We have received generous assistance from Professors Arthur

¹ In this connection we cannot resist the pleasure of quoting two passages, exactly expressing our own views, from the preface to Dr. Waller's *Human Physiology*, which came under our notice after the above paragraph was in type: "I have given a Bibliography after some hesitation, feeling that references to original papers are of no use to junior students, and must be too imperfect to be satisfactory to more advanced students. . . . Attention has been paid to recent work, but I have felt that the gradually-formed deposit of accepted knowledge must be of greater intrinsic value than the latest 'discovery' or the newest theory. An early mental diet in which these items are predominant is an unwholesome diet: their function in elementary instruction is that of condiments, valuable only in conjunction with a foundation of solid food."

² The figures referred to are numbered 618, 619, 1091, 1092, 1093, 1096, 1110, 1111, 1152, 1074, and 1078 in the 3rd edition.

Dendy, G. B. Howes, Baldwin Spencer, and J. T. Wilson, and from Mr. J. P. Hill and Dr. Arthur Willey. Professor W. N. Parker has very kindly read the whole of the proof-sheets and favoured us with many valuable suggestions, besides acting as referee in numerous minor difficulties which would otherwise have cost a delay of many weeks.

It is a mere truism to say that a text-book can never really reflect the existing state of the science of which it treats, but must necessarily be to some extent out of date at the time of publication. In the present instance, the revises of the earlier pages, giving the last opportunity for any but minor alterations, were corrected in the latter part of 1895, and the sheets passed for press in the middle of 1896. We are, therefore, fully alive to the fact that much of our work already needs a thorough revision, and can console ourselves only by reflecting that "to travel hopefully is a better thing than to arrive, and the true success is to labour."

We may mention, in conclusion, that, whatever may be the merits or demerits of the book, it enjoys the distinction of being unique in one respect. The two authors have been separated from one another, during the greater part of their collaboration, by a distance of 1200 miles, and the manuscript, proofs, and drawings have had to traverse half the circumference of the globe in their journeys between the authors on the one hand, and the publishers, printers, artist, and engravers on the other. It will, therefore, be readily believed that all persons concerned have had every opportunity, during the progress of the work, of exercising the supreme virtue of patience.

PREFACE TO THE SECOND EDITION

A NEW edition of this Text-Book has been called for on somewhat short notice, and, had it not been for the assistance generously rendered by Professor W. Newton Parker, who has helped me greatly in the revision of the proofs, and has made a large number of useful suggestions, it would have been impossible for me to have completed the work within the time prescribed. Fortunately, also, materials for the most important of the alterations and additions had been already, to a certain extent, prepared.

The original plan of the work has not been in any way altered, and, though all parts have been subjected to careful revision, there is a good deal, especially in the descriptions of many of the examples, which has not been materially changed. On the other hand, some parts have been to a great extent re-written, and a good many illustrations have been added, a fair proportion of which are new to text-books of this description.

I have the pleasure of acknowledging assistance on special points received from Professor J. P. Hill, Mr. S. J. Johnston, B.A., B.Sc., Mr. E. J. Goddard, B.A., D.Sc., and Mr. H. L. Kesteven, B.Sc., all of the University of Sydney. A good many of the new illustrations were re-drawn by W. Birmingham, Laboratory Assistant, Department of Biology.

W. A. HASWELL.

PREFACE TO THE THIRD EDITION

I HAVE carefully revised all parts of the work, and, in addition to introducing a number of minor alterations and some new illustrations, have re-written certain portions, notably in Sections VI., VIII. and X. Professor W. N. Parker has again rendered invaluable help in the revision of the proofs and has made a number of useful suggestions.

W. A. HASWELL.

SYDNEY,
March 29th, 1921.

CONTENTS

	PAGE
PREFACES	v
CONTENTS OF SECTIONS IN VOL. I.	xiii
LIST OF ILLUSTRATIONS IN VOL. I.	xix
TABLE OF THE CLASSIFICATION OF THE ANIMAL KINGDOM	xxxv
INTRODUCTION	1

SECTION I

THE GENERAL STRUCTURE AND PHYSIOLOGY OF ANIMALS	10
1. Amœba	10
2. The Animal Cell	15
3. The Ovum : Maturation, Impregnation, and Segmentation : the Germinal Layers	20
4. Tissues	25
5. Organs	31
6. The Reproduction of Animals	41
7. Symmetry	42
8. The Primary Subdivisions or Phyla of the Animal Kingdom	43

SECTION II

PHYLUM PROTOZOA	45
Class I. Rhizopoda	46
1. Example of the Class— <i>Amaba proteus</i>	46
2. Classification and General Organisation	47
Systematic Position of the Example.	48
Appendix to the Rhizopoda	65
Class II. Mycetozoa	68
1. Example of the Class— <i>Didymium difforme</i>	68
2. General Remarks	69
Class III. Mastigophora	69
1. Example of the Class— <i>Euglena viridis</i>	69
2. Classification and General Organisation	71
Systematic Position of the Example.	71
Class IV. Sporozoa	82
1. Example of the Class— <i>Monocystis agilis</i>	82
2. Classification and General Organisation	83
Systematic Position of the Example.	84

PHYLUM PROTOZOA— <i>continued</i> .		PAGE
Class V. Infusoria		90
1. Example of the Class— <i>Paramœcium caudatum</i>		90
2. Classification and General Organisation		93
Systematic Position of the Example.		93
Further Remarks on the Protozoa		103
SECTION III		
PHYLUM AND CLASS PORIFERA [PARAZOA]		106
1. Example of the Class— <i>Sycon gelatinosum</i>		106
2. Distinctive Characters and Classification		112
Systematic Position of the Example		114
3. General Organisation		115
SECTION IV		
PHYLUM CŒLENTERATA		129
Class I. Hydrozoa		129
1. Example of the Class— <i>Obelia</i>		129
2. General Structure and Classification.		141
Systematic Position of the Example.		143
Additional Remarks		166
Class II. Scyphozoa		167
1. Example of the Class— <i>Aurelia aurita</i>		167
2. General Structure and Classification.		175
Systematic Position of the Example.		176
Additional Remarks		183
Class III. Actinozoa		183
1. Example of the Class— <i>Tialia crassicornis</i>		183
2. Distinctive Characters and Classification		191
Systematic Position of the Example.		194
3. General Organisation		194
Class IV. Ctenophora		208
1. Example of the Class— <i>Hormiphora plumosa</i>		208
2. Distinctive Characters and Classification		217
Systematic Position of the Example.		218
3. General Organisation		219
The Relationships of the Cœlenterata		223
Appendix to the Cœlenterata—The <i>Mesozoa</i>		227
SECTION V		
PHYLUM PLATYHELMINTHES		232
1. Examples of the Phylum		233
i. <i>Planaria</i> or <i>Dicærocolum</i>		233
ii. <i>Fasciola hepatica</i>		236
iii. <i>Taenia solium</i>		243

PHYLUM PLATYHELMINTHES— <i>continued</i> .	PAGE
2. Distinctive Characters and Classification	248
Systematic Position of the Examples	249
3. General Organisation	250
4. Distribution, Mode of Occurrence, and Mutual Relationships	279
Appendix to Platyhelminthes—Class Nemertinea	284
Distinctive Characters and Classification	290

SECTION VI

PHYLUM NEMATHELMINTHES	292
Class I. Nematoda	292
1. Example of the Class— <i>Ascaris lumbricoides</i>	292
2. Distinctive Characters and Classification	298
Systematic Position of the Example	299
3. General Organisation	299
Class II. Acanthocephala	307
Class III. Chætognatha	310
Appendix to Nematelminthes	313
Family <i>Chartosomatidae</i>	313
,, <i>Echinoderidae</i>	314
,, <i>Desmoscolecidae</i>	314
Affinities and Mutual Relationships of the Nematelminthes	315

SECTION VII

PHYLUM TROCHELMINTHES	316
Class I. Rotifera	317
1. Example of the Class— <i>Brachionus rubens</i>	317
2. Distinctive Characters and Classification	321
Systematic Position of the Example	323
3. General Organisation	323
Class II. Gastrotricha	328
Appendix to Trochelminthes— <i>Dinophilca</i> and <i>Histriobdellea</i>	330

SECTION VIII

PHYLUM MOLLUSCOIDA	333
Class I. Polyzoa	333
1. Example of the Class— <i>Bugula avicularia</i>	334
2. Distinctive Characters and Classification	340
Systematic Position of the Example	341
3. General Organisation	341
Class II. Phoronida	348
Class III. Brachiopoda	353
1. Example of the Class— <i>Magellania lenticularis</i>	353
2. Distinctive Characters and Classification	359
Systematic Position of the Example	359
3. General Organisation	360
Mutual Relationships of the Classes of the Molluscoida	365

SECTION IX

	PAGE
PHYLUM ECHINODERMATA	368
1. Example of the Asteroidea— <i>Astrias rubens</i> or <i>Anthenea flavescens</i>	368
2. Example of the Echinoidea— <i>Strongylocentrotus</i> or <i>Echinus</i>	386
3. Example of the Holothuroidea— <i>Cucumaria</i> or <i>Colochirus</i>	393
4. The Crinoidea— <i>Antedon rosacea</i>	396
5. Distinctive Characters and Classification	401
Systematic Position of the Examples	405
6. General Organisation	406

SECTION X

PHYLUM ANNULATA	429
Class I. Chaetopoda	429
1. Examples of the Class	430
i. <i>Nereis dumerilii</i>	430
ii. <i>Lumbricus</i>	443
2. Distinctive Characters and Classification	454
Systematic Position of the Examples	455
3. General Organisation	457
Appendix I. to the Chaetopoda—Class Myzostomida	477
Appendix II. to the Chaetopoda—Class Echiurida	479
Class II. Sipunculoidea	484
1. Example of the Class— <i>Sipunculus nudus</i>	484
2. Distinctive Characters.	488
3. General Organisation	488
Class III. Archi-annelida	491
Class IV. Hirudinea	494
1. Example of the Class— <i>Hirudo medicinalis</i> and <i>H. australis</i>	494
2. Distinctive Characters and Classification	503
Systematic Position of the Example.	504
3. General Organisation	505
General Remarks on the Annulata	510

SECTION XI

PHYLUM ARTHROPODA	514
Class I. Crustacea	514
1. Examples of the Class	514
i. <i>Apus</i> or <i>Lepidurus</i>	514
ii. <i>Astacus fluviatilis</i>	527
2. Distinctive Characters and Classification	548
Systematic Position of the Examples	555
3. General Organisation	556
Affinities and Mutual Relationships	587
Appendix to Crustacea—Class Trilobita	589
Class II. Onychophora	591

PHYLUM ARTHROPODA— <i>continued</i> .		PAGE
Class III. Myriapoda		598
1. Distinctive Characters and Classification		598
2. General Organisation		600
Class IV. Insecta		602
1. Example of the Class— <i>Periplaneta orientalis</i> or <i>P. americana</i>		603
2. Distinctive Characters and Classification		615
Systematic Position of the Example.		621
3. General Organisation		621
Class V. Arachnida		637
1. Example of the Class— <i>Euscorpio</i> or <i>Buthus</i>		638
2. Distinctive Characters and Classification		644
3. General Organisation		646
Appendix to the Arachnida—the <i>Pycnogonida</i> , <i>Linguatulida</i> , and <i>Tardigrada</i>		657
Relationships of the Air-breathing Arthropoda		659

SECTION XII

PHYLUM MOLLUSCA		663
Class I. Pelecypoda		663
1. Example of the Class— <i>Anodonta</i> and <i>Unio</i>		663
2. Distinctive Characters and Classification		676
Systematic Position of the Examples		678
3. General Organisation		679
Class II. Amphineura		694
1. Distinctive Characters and Classification		694
2. General Organisation		695
Class III. Gastropoda		702
1. Example of the Class— <i>Triton rubicundus</i>		702
2. Distinctive Characters and Classification		713
Systematic Position of the Example.		715
3. General Organisation		715
Appendix to the Gastropoda		736
Class IV. Scaphopoda		736
Class V. Cephalopoda		738
1. Examples of the Class		738
i. <i>Sepia</i>		738
ii. <i>Nautilus pompilius</i>		754
2. Distinctive Characters and Classification		766
Systematic Position of the Examples		767
3. General Organisation		768
General Remarks on the Mollusca		780
INDEX		783

LIST OF ILLUSTRATIONS

VOL. I.

FIG.	PAGE
1. <i>Amœba proteus</i>	10
2. <i>Amœba</i> polypodia, fission	14
3. Alveolar theory of protoplasm	16
4. Reticular theory of protoplasm	17
5. Diagrams illustrating karyokinesis	18
6. Ovum of Sea-urchin	21
7. Maturation and fertilisation of ovum	22
8. Segmentation of ovum	23
9. Gastrulation	24
10. Gastrula	24
11. Various forms of epithelium	25
12. Diagram to illustrate structure of glands	26
13. Gelatinous connective tissue	27
14. Reticular connective tissue	27
15. Fatty tissue	28
16. Hyaline cartilage	28
17. Fibro cartilage	28
18. Bone	29
19. Non-striated muscle	30
20. Striated muscle	30
21. Nerve-cells	31
22. Nerve-fibres	31
23. Various forms of spermatozoa	31
24. Viscera of Frog	34
25. Bones of human arm with biceps muscle	38
26. Nervous system of Frog	39
27. Hydra	41
28. Diagram of axes of body	42
29. Radial symmetry	42
30. <i>Amœba</i> , various species	47
31. <i>Protamœba primitiva</i>	49
32. <i>Quadrula</i> , <i>Hyalosphenia</i> , <i>Arcella</i> , and <i>Diffugia</i>	49
33. <i>Trichospærium sieboldii</i>	50
34. <i>Microgromia socialis</i>	51
35. <i>Chlamydothryx stercorea</i>	52
36. Various forms of Foraminifera	53

	PAGE
10.	
37. Shells of Foraminifera	54
38. <i>Hastirina murrayi</i>	55
39. Dimorphism and alternation of generations in <i>Polystomella</i>	57
40. <i>Actinophrys sol</i>	58
41. <i>Actinosphaerium eichhornii</i>	58
42. Various forms of Heliozoa	60
43. <i>Actinophrys sol</i> , conjugation	61
44. <i>Lithocircus annularis</i>	62
45. <i>Thalassoplaneta brevispicula</i>	63
46. <i>Aulactinium actinastrum</i>	64
47. <i>Actinomma asteracanthion</i>	64
48. <i>Collozoum inerue</i>	65
49. <i>Chlanocydomyxa labyrinthuloides</i>	66
50. <i>Labyrinthula</i>	67
51. <i>Didymium difforme</i>	68
52. <i>Euglena viridis</i>	70
53. Various forms of Flagellata	73
54. Trypanosome	74
55. <i>Hæmatococcus phuvialis</i>	75
56. <i>Pandorina morum</i>	76
57. <i>Copromonas subtilis</i>	77
58. <i>Volvox globator</i>	78
59. Various forms of Choanoflagellata	79
60. Various forms of Dinoflagellata	81
61. <i>Noctiluea miliaris</i>	81
62. <i>Monocystis</i>	82
63. <i>Gregarina</i>	84
64. " development	85
65. <i>Eimeria</i> and <i>Coccidium</i>	86
66. <i>Coccidium</i> , life-history	87
67. Malaria parasites	88
68. <i>Myxidium</i> and <i>Myxobolus</i>	89
69. <i>Sarcocystis miescheri</i>	90
70. <i>Paramoecium caudatum</i>	91
71. " " conjugation	92
72. Various forms of Ciliata	96
73. " " "	97
74. <i>Vorticella</i>	98
75. <i>Zoothamnium arbuseula</i>	99
76. <i>Opalina ranarum</i>	100
77. Various forms of Tentaculifera	102
78. Diagram showing the mutual relationships of the Protozoa	105
79. <i>Sycon gelatinosum</i>	107
80. " " magnified	107
81. " " transverse section	108
82. " " vertical section	109
83. <i>Sycon gelatinosum</i> , pore-membrane	110
84. " " apophyle	110

FIG.	PAGE
85. External form of various Sponges	116
86. <i>Ascetta primordialis</i>	117
87. Diagram of canal-system of various Sponges	118
88. Vertical Section of <i>Spongilla</i>	119
89. Cells of ectoderm of Sponge	120
90. Development of tri-radiate spicule	120
91. Skeleton of various Sponges	121
92. Various forms of Sponge spicules	123
93. <i>Pheronema carpenteri</i>	124
94. Larva of <i>Clathrina blanca</i>	125
95. Development of <i>Sycon raphanus</i>	126
96. <i>Obelia</i>	131
97. „ Vertical section of polype	133
98. Nematocysts of <i>Hydra</i>	134
99. Tentacle of <i>Eucope</i>	135
100. <i>Obelia medusa</i>	136
101. Diagram of medusa	137
102. Derivation of medusa from polype	138
103. Projections of polype and medusa	139
104. Development of zoophyte	140
105. <i>Bougainvillea ramosa</i>	144
106. Various forms of <i>Leptolineæ</i>	145
107. <i>Ceratella</i>	146
108. <i>Hydra</i>	147
109. <i>Protohydra leuckartii</i>	148
110. Various forms of leptoline Medusæ	150
111. Diagram illustrating formation of sporosac by degradation of medusa	152
112. Early development of <i>Eucope</i>	153
113. Two <i>Trachymedusæ</i>	154
114. Two <i>Narcomedusæ</i>	155
115. <i>Æginura</i> , tentaculocyst	155
116. Larva of <i>Æginopsis</i>	156
117. <i>Millepora alcornis</i> , skeleton	157
118. <i>Millepora</i> , diagram of structure	158
119. <i>Stylaster sanguineus</i> , skeleton	159
120. <i>Halitemma tergestinum</i>	160
121. Diagram of a Siphonophore	161
122. Development of <i>Halitemma</i>	162
123. <i>Physalia</i>	163
124. <i>Diphyes campanulata</i>	164
125. <i>Porpita pacifica</i>	165
126. <i>Graptolites</i>	166
127. <i>Aurelia aurita</i> , dorsal and ventral views	168
128. „ „ side view and vertical section	170
129. „ „ portion of umbrella with tentaculocyst	171
130. <i>Aurelia aurita</i> , development	173
131. <i>Tessera princeps</i>	177

FIG.	PAGE
132. <i>Lucernaria</i>	177
133. <i>Pericarpa quadrigata</i>	178
134. <i>Nausithoë</i>	179
135. <i>Charybdea marsupialis</i>	180
136. <i>Pilema pulmo</i>	181
137. <i>Pelagia noctiluca</i> , development	182
138. <i>Tealia crassicornis</i> , dissection and transverse section	184
139. Diagrammatic sections of <i>Sea-anemone</i>	186
140. <i>Tealia crassicornis</i> , section of tentacle	188
141. Nematocysts of <i>Sagartia</i>	188
142. Section of mesenteric filament of <i>Sagartia</i>	189
143. Transverse sections of embryos of <i>Actinia</i>	191
144. <i>Zoanthus sociatus</i>	195
145. <i>Harteria elegans</i>	195
146. <i>Coralium rubrum</i>	196
147. <i>Astraea pallida</i>	196
148. <i>Pennatula sulcata</i>	197
149. <i>Tubipora musica</i>	197
150. <i>Edwardsia claparèdii</i>	198
151. <i>Antipathes ternatensis</i>	198
152. <i>Parantipathes</i> and <i>Schizopathes</i>	199
153. <i>Minyas</i>	200
154. <i>Acyonium palmatum</i>	200
155. <i>Gorgonia verrucosa</i>	201
156. Structure of simple coral	203
157. <i>Dendrophyllia</i> and <i>Madrepora</i>	204
158. <i>Adamsia palliata</i>	206
159. <i>Hormiphora plumosa</i>	208
160. " " dissection and transverse section	209
161. " " diagrammatic sections	211
162. " " section of branch of tentacle	212
163. " " sense-organ	213
164. Ovum of <i>Lampetia</i>	214
165. Segmentation of oosperm in <i>Ctenophora</i>	215
166. Development of <i>Ctenophora</i>	215
167. Development of <i>Callianira</i>	215
168. " " (later stages)	216
169. Three <i>Cydlippida</i>	219
170. <i>Deiopia kaloknenota</i>	220
171. <i>Cestus veneris</i>	220
172. <i>Beroë forskalii</i>	221
173. <i>Ctenoplana kowalevskii</i>	221
174. <i>Tjulfiella</i>	222
175. <i>Hydroctena salenskii</i>	225
176. Sections of embryos of <i>Actinia</i> and <i>Beroë</i>	226
177. Diagram illustrating the mutual relationships of the <i>Celenterata</i>	227
178. <i>Dicyema paradoxum</i> with infusoriform embryos	228
179. " " " vermiform "	228

FIG.	PAGE
180. <i>Dicelyma paradoxum</i> , male	229
181. <i>Rhopalura giardii</i> , male	230
182. „ „ female	230
183. <i>Salinella</i> , longitudinal section	231
184. „ „ transverse „	231
185. <i>Planaria</i> , digestive and excretory systems	234
186. „ „ nervous system	234
187. „ „ reproductive system	236
188. Transverse section of a <i>Planarian</i>	237
189. <i>Fasciola hepatica</i>	237
190. „ „ section of integument	238
191. „ „ internal organisation	239
192. „ „ terminal part of reproductive apparatus	240
193. „ „ development	241
194. <i>Tænia solium</i>	242
195. „ „ head	243
196. „ „ transverse section	244
197. „ „ proglottis	245
198. „ „ ripe proglottis	246
199. „ „ development	247
200. Various <i>Planarians</i>	251
201. <i>Gunda segmentata</i>	252
202. Digenetic Trematodes	253
203. <i>Gyrodactylus</i> and <i>Polystomum</i>	254
204. <i>Temnocephala</i>	255
205. <i>Actinodactylella</i>	256
206. <i>Tetrahynchus</i>	257
207. <i>Tænia echinococcus</i>	257
208. <i>Ligula</i>	257
209. <i>Caryophyllæus</i>	258
210. <i>Gyrocotyle</i>	258
211. <i>Archigetes</i>	258
212. Section of body-wall of a <i>Triclad</i>	259
213. Parenchyma of Flat-worm	259
214. Diagram of <i>Rhabdocœle</i>	261
215. „ „ <i>Polyclad</i>	261
216. „ „ <i>Triclad</i>	262
217. Flame-cell	264
218. Reproductive organs of <i>Mesostomum ehrenbergii</i>	267
219. Developing egg of <i>Planocera</i>	269
220. Embryo of <i>Planocera</i>	270
221. Müller's larva of <i>Yungia</i>	271
222. Embryos of <i>Dendrocœlum</i>	272
223. Embryo of <i>Temnocephala</i>	273
224. „ „	274
225. A <i>Cysticeroid</i>	276
226. „ „ with head evaginated	276
227. Cyst of <i>Tænia echinococcus</i>	277

FIG.	PAGE
228. Scoleces	277
229. Scolex of <i>Tenia echinococcus</i>	277
230. Process of budding in <i>Microstomum</i>	278
231. <i>Bilharzia haematobia</i>	281
232. Diagram of the relationships of the Platyhelminthes and Nemertinea	283
233. Diagram of Nemertine	284
234. Proboscis of Nemertine	285
235. <i>Tetrastemma</i>	286
236. Anterior portion of Nemertine	287
237. Proboscis of Metanemertean, retracted	287
238. " " " everted	287
239. Transverse section of Nemertean	288
240. Diagram of anterior end of Nemertean	289
241. <i>Pilidium</i>	290
242. <i>Ascaris lumbricoides</i>	293
243. " " transverse section	294
244. " " muscle fibres	295
245. " " dissection of female	296
246. Nervous system of Nematoda	297
247. <i>Ascaris lumbricoides</i> , dissection of male organs	297
248. Body-wall of platymyarian Nematode	300
249. <i>Dochmius duodenalis</i>	300
250. Transverse section of <i>Gordius</i>	301
251. <i>Oxyuris</i>	302
252. <i>Gordius</i> , anatomy	303
253. <i>Trichinella spiralis</i>	305
254. Two species of <i>Echinorhynchus</i> (<i>Gigantorhynchus</i>)	307
255. <i>Echinorhynchus gigas</i> , dissection of male	308
256. " " " female	308
257. " " " nephridia	309
258. " " " female organs	309
259. Egg of <i>Echinorhynchus acus</i>	310
260. <i>Sagitta hexaptera</i>	311
261. " <i>bipunctata</i> , transverse sections	312
262. " " head	312
263. " <i>hexaptera</i> , eye	312
264. Development of <i>Sagitta</i>	313
265. <i>Chaetosoma</i>	313
266. <i>Echinoderes</i>	314
267. <i>Desmoscolex</i>	314
268. <i>Trochophore</i>	316
269. <i>Brachionus rubens</i> , female	318
270. " " pharynx	319
271. " " male and female, with attached eggs	319
272. Diagram of a Rotifer	320
273. <i>Paraceraspianchus</i>	322
274. Typical forms of <i>Rotifera</i>	324
275. " " " "	325

LIST OF ILLUSTRATIONS

XXV

FIG.	PAGE
276. Typical forms of mastax	326
277. <i>Chaetonotus maximus</i>	329
278. " " anatomy	329
279. <i>Dinophilus taniatus</i>	330
280. <i>Stratiodrillus tasmanicus</i>	331
281. <i>Bugula avicularia</i>	335
282. Development of <i>Bugula</i>	337
283. " " "	338
284. Larva of <i>Bugula</i>	339
285. <i>Plumatella</i>	342
286. <i>Cristatella</i>	343
287. <i>Lophopus</i>	344
288. <i>Pedicellina</i>	347
289. <i>Phoronis australis</i>	348
290. " " free end	349
291. " " internal organisation	349
292. " " section	350
293. <i>Actinotrocha</i> larva of <i>Phoronis</i>	351
294. " " "	352
295. <i>Magellania flavescens</i> , shell	354
296. " <i>lenticularis</i> , anatomy	356
297. " <i>flavescens</i> , lophophore	357
298. " muscular system	357
299. <i>Terebratula</i> , nervous system, &c.	358
300. Typical Brachiopods	360
301. " " anatomy	361
302. Development of <i>Cistella</i>	363
303. Larva of <i>Cistella</i>	363
304. Development of <i>Cistella</i>	364
305. Lophophore of embryo Brachiopod	365
306. Diagrams of phylactolæmatous Polyzoan and <i>Phoronis</i>	366
307. Starfish, oral aspect	369
308. " vertical section of arm	371
309. " portion of vertical section of arm	373
310. " diagrammatic sections	374
311. <i>Asterias rubens</i> , digestive system	375
312. <i>Astropecten</i> , section of stone-canal	375
313. <i>Anthenea flavescens</i> , dissection from dorsal aspect	376
314. <i>Asterias rubens</i> , structure	377
315. <i>Anthenea flavescens</i> , lateral dissection	378
316. " " aboral surface	379
317. " " oral surface	379
318. <i>Asterina gibbosa</i> , development	381
319. " " "	382
320. " " larva	383
321. " " "	384
322. " <i>exigua</i> , young after metamorphosis	384
323. <i>Asterina gibbosa</i> , development	385

FIG.	PAGE
324. Apical system of young Starfish	385
325. Echinus esculentus, peristome	386
326. Strongylocentrotus	387
327. Corona of Sea-urchin	388
328. Apical disc of Sea-urchin	389
329. Echinus, lantern of Aristotle	390
330. Sea-urchin, anatomy, lateral view	390
331. Echinoid, transverse section of ambulacral zone	391
332. Sea-urchin, anatomy, oral view	392
333. Cucumaria planei	393
334. Anatomy of a Holothurian	395
335. Antedon	397
336. Aboral view of Antedon	397
337. Antedon disc	398
338. .. transverse section of pinnule	399
339. .. sagittal section	400
340. Anthenea, ventral view	410
341. Ophioglypha lacertosa	411
342. Astrophyton arborescens	412
343. Diagram of spine of Sea-urchin	413
344. Pedicellaria of Arbacia punctulata	413
345. Hemipneustes radiatus	414
346. Clypeaster sub-depressus	414
347. Metacrinus interruptus	415
348. Development of Echinoderms	422
349. Antedon	423
350. Stalked larva of Antedon	424
351. Diagram to illustrate the relationships of the classes of Echino- dermata	428
352. Nereis dumerilii	430
353. parapodium	431
354. setæ	431
355. Nereis diversicolor, proboscis	433
356. Nereis dumerilii, anatomy	434
357. transverse section	435
358. nervous system	436
359. eye	437
360. nephridium	438
361. development	440
362.	442
363. Lumbricus	444
364. .. setæ	445
365. .. transverse section	446
366. .. sagittal section	447
367. .. nervous system	448
368. .. nephridium	450
369. .. reproductive organs	451
370. .. development	453

FIG	PAGE
371. <i>Polynœ setosissima</i>	457
372. <i>Galcolaria cœspitosa</i>	457
373. <i>Chaetopterus</i>	458
374. <i>Setæ</i> of various <i>Polychæta</i>	458
375. Section of setigerous sac of an <i>Oligochæte</i>	458
376. <i>Polynœ extenuata</i> , anterior end	459
377. <i>Polychæta</i> , various, heads	460
378. <i>Tu ifex</i>	461
379. <i>Terebella</i>	462
380. Aphrodite, enteric canal	464
381. <i>Saccocirrus</i> , transverse section	466
382. <i>Phyllodoce</i> , nephridium	468
383. Nephridia and cœlomoduets	469
384. Diagram illustrating development of gonad of <i>Polychæta</i>	470
385. <i>Pionosyllis elegans</i>	472
386. <i>Spirorbis lævis</i>	473
387. <i>Eupomatus</i> , development of trochophore	474
388. <i>Autolytus cornutus</i> , budding	475
389. <i>Syllis ramosa</i>	476
390. <i>Serpulæ</i> with their tubes	476
391. <i>Myzostoma</i>	478
392. „ anatomy	479
393. <i>Echiurus</i>	480
394. „ anatomy	481
395. „ nervous system	481
396. <i>Bonellia viridis</i> , female	482
397. <i>Bonellia</i> , anatomy	482
398. <i>Echiurus</i> , ciliated funnel	482
399. <i>Bonellia</i> , male	483
400. <i>Echiurus</i> , trochophore	483
401. <i>Sipunculus nudus</i> , anterior extremity	485
402. „ „ tentacular fold.	485
403. „ „ anatomy	486
404. „ „ nervous system	486
405. <i>Priapulus</i>	490
406. <i>Polygordius neapolitanus</i>	491
407. <i>Protodrilus</i>	492
408. <i>Polygordius neapolitanus</i> , transverse section	492
409. „ „ trochophore	493
410. „ „ „ later stage	493
411. <i>Hirudo medicinalis</i>	495
412. „ „ transverse section	496
413. „ „ jaw	497
414. „ <i>australis</i> , dissection from dorsal aspect	498
415. „ <i>australis</i> „ „ left side	499
416. „ <i>medicinalis</i> , nephridium	500
417. „ diagram of blood-channels	501
418. „ section of eye	502

FIG.	PAGE
419. Hirudo, cocoon	503
420. Three Rhynchobdellida	506
421. Proboscis of Clepsine	506
422. Nephridium of Herpobdella	507
423. Pontobdella, nephridial system	507
424. Clepsine, development	508
425. Diagram of origin of metamerism	511
426. Diagram illustrating the relationships of the Annulata and Trochelmintles	513
427. Apus canceriformis, dorsal aspect	515
428. Lepidurus kirkii, side view	516
429. Apus glacialis, ventral aspect	517
430. „ appendages	518
431. Lepidurus kirkii, sagittal section	520
432. Apus, transverse section	521
433. „ shell-gland	522
434. „ canceriformis, nervous system	523
435. „ structure of paired eye	524
436. „ development	525
437. Astacus fluviatilis, male	527
438. „ „ transverse section of abdomen	527
439. „ „ appendages	529
440. „ „ articulations and muscles of leg	532
441. Section of skin and exoskeleton of Lobster	533
442. Articulations and muscles of abdomen of Crayfish	534
443. Astacus fluviatilis, dissection from right side	535
444. „ „ gills	536
445. „ „ kidney	538
446. „ „ transverse section of thorax	539
447. „ „ diagram of circulation	540
448. „ „ nervous system	541
449. „ „ reproductive organs	543
450. „ „ formation of the blastoderm	544
451. „ „ ventral view of embryo	544
452. „ „ nauplius	545
453. „ „ sections of embryos	546
454. „ „ development of appendages	547
455. Three Branchiopoda	557
456. „ Cladocera	558
457. Cypris	559
458. Cyclops and Calocalanus	560
459. Various forms of parasitic Eucopepoda	561
460. Argulus foliaceus	562
461. Lepas anatifera	564
462. Balanus	564
463. Saccalinus carcini	565
464. Nebalia geoffroyi	566
465. Paramuspides	567

FIG.	PAGE
466. <i>Mysis oculata</i>	567
467. <i>Diastylis</i>	568
468. <i>Gammarus</i>	569
469. <i>Asellus</i>	570
470. Amphipoda	571
471. Isopoda	572
472. Shrimp and Prawn	573
473. <i>Scyllarus arctus</i>	574
474. <i>Pagurus bernhardus</i>	574
475. <i>Cancer pagurus</i>	575
476. Typical <i>Brachyura</i>	576
477. <i>Squilla</i>	577
478. <i>Orchestia cavimana</i> , anatomy	579
479. <i>Euphausia pellucida</i>	580
480. Nervous system of Crab	581
481. Cypris-stage of <i>Lepas</i>	583
482. Larvæ of Crabs	584
483. Diagram illustrating the mutual relationships of the orders of Crustacea	588
484. <i>Dalmanites</i> and <i>Phacops</i>	589
485. <i>Triarthrus becki</i>	590
486. <i>Peripatus capensis</i>	591
487. ventral view of head	592
488. .. anatomy	593
489. .. tracheal pit	593
490. .. nephridium	594
491. .. <i>novæ zealandiæ</i> , development	595
492. .. <i>capensis</i>	596
493. <i>Scolopendrella immaculata</i>	598
494. <i>Scolopendra</i>	599
495. <i>Lithobius forficatus</i>	599
496. <i>Pauropus huxleyi</i>	600
497. <i>Strongylostoma</i> , development	602
498. <i>Periplaneta orientalis</i>	604
499. .. mouth-parts	605
500. .. <i>americana</i> , lateral view of head	605
501. .. muscular system	607
502. .. anatomy	608
503. .. salivary glands	609
504. Trachea of caterpillar	610
505. <i>Periplaneta</i> , tracheal system	610
506. .. nervous system	611
507. .. male reproductive organs	611
508. .. female reproductive organs	611
509. Segmentation of ovum of Insect	612
510. Ventral plate of embryo Cockroach	614
511. Embryo Cockroach	614
512. <i>Lepisma</i>	616

FIG.	PAGE
513. Podura	616
514. Locusta	617
515. An Embiid	617
516. Psocus fasciatus	617
517. Mallophaga	617
518. Ephemera	618
519. Aphis rosæ	618
520. Cicada	619
521. Culex and larva	619
522. Gastrophilus equi	619
523. Picris	620
524. Crioceris	620
525. Panorpa communis	621
526. Section of integument of Insect	622
527. Mouth-parts of Honey-bee	622
528. „ „ Diptera	623
529. „ „ Lepidoptera	624
530. Digestive organs of Beetle	626
531. Nervous, tracheal, and digestive systems of the Honey-bee	626
532. Tracheal gills of Ephemerid	628
533. Heart of Cockchafer	628
534. Nervous system of Diptera	629
535. Ocellus of Dytiscus larva	630
536. Sexual apparatus of Honey-bee	631
537. Segmentation of ovum of Insect	633
538. Germinal layers and amnion of Insect	633
539. Development of Hydrophilus	634
540. „ „	635
541. Apis mellifica, queen, worker, and drone	636
542. Formica rufa	636
543. Eusecorpio	639
544. Ventral surface of cephalothorax and pre-abdomen of Scorpion	639
545. Endosternite of Scorpion	640
546. Scorpion, anatomy, lateral view	641
547. „ „ dorsal „	642
548. „ „ development	643
549. Embryo of Scorpion	644
550. Chelifer bravaisii	646
551. Phrynus	647
552. Galeodes dastuguei	647
553. Epeira diadema	648
554. „ „ chelicere and pedipalpi of female	648
555. „ „ pedipalp of male	648
556. Sarcoptes scabiei	649
557. Trombidium fuliginosum	649
558. Limulus	650
559. „ ventral view	651
560. Eurypterus fischeri	652

FIG.	PAGE
561. Anatomy of dipneumonous Spider	653
562. <i>Limulus</i> , sagittal section	654
563. Book-lung of spider	654
564. Tracheal system of Spider	655
565. Book-gill of <i>Limulus</i>	655
566. Lateral eye of <i>Euscorpio</i>	655
567. Central eye of <i>Euscorpio</i>	656
568. <i>Nymphon hispidum</i>	657
569. <i>Pentastomum tænioides</i>	658
570. <i>Macrobotus hufelandi</i>	658
571. Diagram to illustrate affinities of Arthropoda	661
572. <i>Anodonta cygnea</i>	664
573. interior of valve and animal removed from shell	665
574. section of shell and mantle	666
575. animal after removal of mantle-lobe	667
576. dissection from left side	668
577. structure of gills	669
578. transverse sections	670
579. .. diagram of circulation	672
580. .. statocyst	673
581. .. early embryo	674
582. .. later embryos	675
583. .. advanced embryo	675
584. .. metamorphosis	676
585. Anatomy of <i>Pecten</i>	679
586. Valves of <i>Mya</i> , <i>Modiola</i> , and <i>Vulsella</i>	680
587. <i>Cardium edule</i>	680
588. <i>Venus gnidia</i>	681
589. <i>Serobicularia piperata</i>	681
590. <i>Solecurtus strigillatus</i>	682
591. Diagram of concrescence of mantle-lobes	682
592. <i>Requienia</i> and <i>Hippurites</i>	683
593. <i>Teredo navalis</i>	683
594. <i>Aspergillum</i>	684
595. <i>Mytilus edulis</i>	684
596. <i>Nucula delphinodonta</i>	684
597. Gills of <i>Pelecypoda</i>	685
598. Gill-filaments of <i>Mytilus</i>	686
599. Dissection of <i>Poromya</i>	686
600. <i>Donax</i> , enteric canal	687
601. Nervous system and auditory organs of <i>Nucula</i>	688
602. Eye of <i>Pecten</i>	689
603. Development of <i>Ostrea</i>	690
604. Veliger of <i>Ostrea</i>	691
605. Embryos of <i>Cyelas</i>	691
606. Diagram illustrating the mutual relationships of the <i>Pelecypoda</i>	693
607. <i>Chatoderma nitidulum</i>	695
608. <i>Neomenia carinata</i>	695

	PAGE
116.	696
609. <i>Chiton spinosus</i> , dorsal view	696
610. „ „ ventral view	696
611. „ „ valves of shell	696
612. <i>Chitoderma nitidulum</i> , longitudinal section	697
613. <i>Chiton</i> , longitudinal section	697
614. Nervous system of <i>Amphineura</i>	698
615. <i>Neomenia carinata</i> , reproductive organs	699
616. <i>Chiton</i> , nephridial and genital systems	700
617. <i>Chiton</i> , development	701
618. <i>Triton rubicundus</i> , shell	703
619. „ „ shell, median section	703
620. „ „ operculum	704
621. „ „ lateral view of body	705
622. „ „ diagram of introvert	705
623. „ „ dissection from dorsal side	707
624. „ „ buccal mass	708
625. „ „ vertical section of buccal cavity	708
626. „ „ nervous system from dorsal side	710
627. „ „ „ „ and related parts, lateral view	711
628. „ „ section of eye	712
629. Diagrams of displacement of mantle-cavity, &c.	716
630. <i>Solarium perspectivum</i>	718
631. <i>Terebra oculata</i>	718
632. <i>Cypræa moneta</i>	719
633. <i>Doris tuberculata</i>	719
634. <i>Carinaria mediterranea</i>	719
635. <i>Limax</i>	719
636. <i>Sigaretus levigatus</i>	720
637. <i>Aplysia</i>	720
638. Shell-bearing Pteropoda	721
639. <i>Atlanta peronii</i>	721
640. <i>Pterotrachea scutata</i>	721
641. <i>Helix nemoralis</i>	722
642. <i>Pleurophyllidia lineata</i>	723
643. <i>Patella vulgata</i>	723
644. Pulmonary cavity and related parts in <i>Limax</i>	723
645. Nervous system of <i>Patella</i>	725
646. „ „ „ <i>Aplysia</i>	726
647. „ „ „ <i>Limnæus</i>	726
648. Eyes of Gastropoda	727
649. Osphradium of <i>Murex</i>	727
650. Reproductive organs of <i>Helix</i>	728
651. Ovary of Gastropoda	729
652. Forms of egg-cases in Gastropoda	730
653. Segmentation and formation of germinal layers in Gastropoda	731
654. Early development of <i>Patella</i>	732
655. Trochophore of <i>Patella</i>	733
656. Later trochophore of <i>Patella</i>	733

FIG.	PAGE
657. Veliger of <i>Vermetus</i>	734
658. Diagram illustrating the relationships of the Gastropoda	736
659. Dentalium, section of shell	736
660. " anatomy	737
661. " larvæ	737
662. <i>Sepia cultrata</i>	739
663. " " shell	740
664. " chromatophore	741
665. " <i>cultrata</i> , cranial cartilage	742
666. " " nuchal cartilage	742
667. " " mantle-cavity	743
668. " <i>officinalis</i> , jaws	744
669. " section of buccal mass	744
670. " <i>officinalis</i> , enteric canal	745
671. " <i>cultrata</i> , dissection of male from posterior aspect	746
672. " " lateral dissection of male	747
673. " <i>officinalis</i> , longitudinal section of ink-sac	747
674. " <i>cultrata</i> vascular system	748
675. " " cephalic ganglia	748
676. " " pedal and pleuro-visceral ganglia	748
677. " section of eye	749
678. " <i>cultrata</i> , statolith	750
679. " <i>officinalis</i> , renal organs	751
680. " " diagrammatic sagittal section of female	752
681. " male reproductive organs	753
682. " sperms and spermatophore	753
683. <i>Nautilus pompilius</i> , section of shell	754
684. " " female in shell	756
685. <i>Nautilus macromphalus</i> , entire animal	757
686. <i>Nautilus pompilius</i> , lobe of foot	758
687. " " spadix	759
688. " " cephalic cartilage	759
689. " " mantle-cavity of male	760
690. " " dissection of male from left side	762
691. " " arteries	763
692. " " renal sacs, ctenidia, &c.	764
693. " " male reproductive organs	765
694. " " female " "	766
695. " <i>macromphalus</i> , egg	766
696. <i>Octopus vulgaris</i>	768
697. <i>Loligo vulgaris</i>	769
698. <i>Argonauta argo</i>	769
699. <i>Octopus lentus</i> , male	770
700. <i>Amphitretus pelagicus</i>	770
701. Shell of <i>Spirula</i>	771
702. <i>Spirula peronii</i>	771
703. Ammonite	772
704. Shell of Belemnite	772

FIG.	PAGE
705. Shell of <i>Argonauta argo</i>	773
706. Segmentation of <i>Loligo</i>	774
707. Blastoderm of <i>Sepia</i>	775
708. " " sections	775
709. Development of <i>Loligo</i>	776
710. " "	777
711. " "	777
712. " "	778
713. Diagram to illustrate the relationships of the Cephalopoda	780

CLASSIFICATION OF THE ANIMAL KINGDOM IN THIS BOOK

KINGDOM ANIMALIA.

PHYLUM I. PROTOZOA.

Class I. RHIZOPODA.

- Order 1. LOBOSA.
- „ 2. FILOSA.
- „ 3. FORAMINIFERA.
- „ 4. HELIOZOA.
- „ 5. RADIOZOA.

Class II. MYCETOZOA.

Class III. MASTIGOPHORA.

- Order 1. FLAGELLATA.
- „ 2. CHOANOFAGELLATA.
- „ 3. DINOFLAGELLATA.

Order 4. CYSTOFLAGELLATA

Class IV. SPOROZOA.

- Order 1. GREGARINIDA.
- „ 2. COCCIDIIDEA.
- „ 3. HÆMOSPORIDIA.
- „ 4. MYXOSPORIDIA.
- „ 5. SARCOCYSTIDEA.

Class V. INFUSORIA.

- Order 1. CILIATA.
- „ 2. TENTACULIFERA.

PHYLUM II. PORIFERA (PARAZOA).

Class PORIFERA.

Sub-class I. Calcarea.

- Order 1. HOMOCÆLA.
- „ 2. HETEROCÆLA.

Sub-class II. Hexactinellida.

Sub-class III. Demospongia.

- Order 1. TETRACTINELLIDA.
- „ 2. MONAXONIDA.
- „ 3. CERATOSA.
- „ 4. MYXOSPONGIA.

PHYLUM III. CŒLEENTERATA.

Class I. HYDROZOA.

- Order 1. LEPTOLINÆ.
- Sub-order *a.* *Anthomedusæ.*
- „ *b.* *Leptomedusæ.*
- Order 2. TRACHYLINÆ.
- Sub-order *a.* *Trachymedusæ.*
- „ *b.* *Narcomedusæ.*
- Order 3. HYDROCORALLINA.
- „ 4. SIPHONOPHORA.
- „ 5. GRAPTOLITHIDA.

Class II. SCYPHOZOA.

- Order 1. STAUROMEDUSÆ.
- „ 2. CORONATA.
- „ 3. CUBOMEDUSÆ.
- „ 4. DISCOMEDUSÆ.
- Sub-order *a.* *Semostomæ.*
- „ *b.* *Rhizostomæ.*

Class III. ACTINOZOA.

Sub-class I. Zoantharia.

- Order 1. ACTINIARIA.
- „ 2. MADREPORARIA.
- „ 3. ANTIPATHARIA.

Sub-class II. Alcyonaria.

- Order 4. ALCYONACEA.
- „ 5. GORGONACEA.
- „ 6. PENNATULACEA.

Class IV. CTENOPHORA.

- Order 1. CYDIPPIDA.
- „ 2. LOBATA.
- „ 3. CESTIDA.
- „ 4. BEROÏDA.
- „ 5. PLATYCTENEÆ.

Appendix to Cœlenterata—*Mesozoa*

PHYLUM IV. PLATYHELMINTHES.

Class I. **TURBELLARIA.**

- Order 1. POLYCLADIDA.
- „ 2. TRICLADIDA.
- „ 3. RHABDOCÆLIDA.

Order 3. ASPIDOCOTYLEA.

- „ 4. TEMNOCEPHALEA.

Class III. **CESTODA.**

- Order 1. MONOZOA.
- „ 2. POLYZOA (MEROZOA).

Class II. **TREMATODA.**

- Order 1. MONOGENETICA.
- „ 2. DIGENETICA.

Appendix to Platyhelminthes—Class
NEMERTINEA.

PHYLUM V. NEMATHELMINTHES.

Class I. **NEMATODA.**

- Order 1. NEMATOIDEA.
- „ 2. NEMATOMORPHA.

Class III. **CHÆTOGNATHA.**

Appendix to Nematelminthes—
Chatosomatida, *Echinoderidæ*, and
Desmoscolocidæ.

Class II. **ACANTHOCEPHALA.**

PHYLUM VI. TROCHELMINTHES.

Class I. **ROTIFERA.**

- Order 1. RHIZOTA.
- „ 2. BDELLOÏDA.
- „ 3. PLOÏMA.
- Sub-order *a. Illoricata.*
- „ *b. Loricata.*

Order 4. SCIRTOPODA.

- „ 5. TROCHOSPHERIDA.
- „ 6. SEISONIDA.

Class II. **GASTROTRICHA.**

Appendix to Trochelminthes—*Dino-*
phileæ and *Histriobdelleæ*.

PHYLUM VII. MOLLUSCOIDA.

Class I. **POLYZOA.**

- Sub-class 1. **Ectoprocta.**
- Order 1. GYMNOLEMATA.
- Sub-order *a. Cyclostomata.*
- „ *b. Chevlostomata.*
- „ *c. Ctenostomata.*

Order 2. PHYLACTOLEMATA.

Sub-class II. **Endoprocta.**

Class II. **PHORONIDA.**

- „ III. **BRACHIOPODA.**
- Order 1. INARTICULATA.
- „ 2. ARTICULATA.

PHYLUM VIII. ECHINODERMATA.

SUB-PHYLUM I. **ELEUTHEROZOA.**

Class I. **ASTEROIDEA.**

- Order 1. SPINULOSA.
- „ 2. VELATA.
- „ 3. PAXILLOSA.
- „ 4. VALVATA.
- „ 5. FORCIPULATA.

Order 4. ZYGOPHURÆ.

Class III. **ECHINOIDEA.**

- Order 1. REGULARIA.
- „ 2. CLYPEASTRIDEA.
- „ 3. SPATANGOIDEA.

Class II. **OPHIUROIDEA.**

- Order 1. LYSOPHURÆ.
- „ 2. STREPTOPHURÆ.
- „ 3. CLADOPHURÆ.

Class IV. **HOLOTHUROIDEA.**

- Order 1. ELASIPODA.
- „ 2. PEDATA.
- „ 3. APODA.

PHYLUM VIII. ECHINODERMATA—*continued.*

SUB-PHYLUM II. PELMATOZOA.

Class I. **CRINOIDEA.**

Sub-class I. **Monocyclica.**

„ II. **Dicyclica.**

Class II. **CYSTOIDEA.**

Class III. **BLASTOIDEA.**

„ IV. **EDRIASTEROIDEA.**

„ V. **CARPOIDEA.**

PHYLUM IX. ANNULATA.

Class I. **CHÆTOPODA.**

Sub-class I. **Polychæta.**

Order 1. **ARCHI-CHÆTOPODA.**

„ 2. **PHANEROCEPHALA.**

„ 3. **CRYPTOCEPHALA.**

Sub-class II. **Oligochæta.**

Order 1. **MICRODRILL.**

„ 2. **MEGADRILL.**

Appendix I. to the Chetopoda—Class

MYZOSTOMIDA.

Appendix II. to the Chetopoda—

Class **ECHIURIDA.**

Class II. **SIPUNCULOIDEA.**

„ III. **ARCHI-ANNELIDA.**

„ IV. **HIRUDINEA.**

Order 1. **RHYNCHOBDELLIDA.**

„ 2. **ARRHYNCHOBDELLIDA.**

Sub-order 1. *Gnathobdellida.*

„ 2. *Herpobdellida.*

PHYLUM X. ARTHROPODA.

Class I. **CRUSTACEA.**

Sub-class I. **Branchiopoda.**

Order 1. **ANOSTRACA.**

„ 2. **NOTOSTRACA.**

„ 3. **CONCHOSTRACA.**

„ 4. **CLADOCERA.**

Sub-class II. **Ostracoda.**

„ III. **Copepoda.**

Order 1. **EUCOPEPODA.**

„ 2. **BRANCHIURA.**

Sub-class IV. **Cirripedia.**

Order 1. **EUCIRRIPEDIA.**

„ 2. **RHIZOCEPHALA.**

Sub-class V. **Malacostraca.**

Series I. **Leptostraca.**

„ II. **Eumalacostraca.**

Division I. **Syncarida.**

Order **ANASPIDACEA.**

Division 2. **Peracarida.**

Order 1. **MYSIDACEA.**

„ 2. **CUMACEA.**

„ 3. **TANAIDACEA.**

„ 4. **IPOPODA.**

„ 5. **AMPHIPODA.**

Division 3. **Eucarida.**

Order 1. **EUPHAUSIACEA.**

„ 2. **DECAPODA.**

Sub-order 1. *Macrura.*

Sub-order 2. *Anomura.*

„ 3. *Brachyura.*

Division 4. **Hoplocarida.**

Order **STOMATOPODA.**

Appendix to Crustacea—Class **TRILOBITA.**

Class II. **ONYCHOPHORA.**

„ III. **MYRIAPODA.**

Sub-class I. **Progoneata.**

Order 1. **PAUROPODA.**

„ 2. **DIPLOPODA** (**CHILO-**
GNATHA).

„ 3. **SYMPHYLA.**

Sub-class II. **Opisthogoneata.**

Order 1. **CHILOPODA.**

Class IV. **INSECTA.**

Sub-class I. **Apterygota.**

Order 1. **THYSANURA.**

„ 2. **COLLEMBOLA.**

Sub-class II. **Pterygota.**

Order 3. **ORTHOPTEROIDEA.**

Sub-order 1. *Orthoptera.*

„ 2. *Isoptera.*

„ 3. *Embiide.*

„ 4. *Psocidæ.*

„ 5. *Mallophaga.*

PHYLUM X. ARTHROPODA—*continued*.Class IV. **INSECTA**—*cont.*Sub-class II. **Pterygota**—*cont.*

- Order 4. NEUROPTERA.
- „ 5. THYSANOPTERA.
- „ 6. HEMIPTERA.
- „ 7. DIPTERA.
- „ 8. LEPIDOPTERA.
- „ 9. COLEOPTERA.
- „ 10. MECOPTERA.
- „ 11. HYMENOPTERA.

Class V. **ARACHNIDA**.

Order 1. SCORPIONIDA.

- „ 2. PSEUDOSCORPIONIDA.
- „ 3. PEDIPALPIDA.
- „ 4. SOLPUGIDA.
- „ 5. PHALANGIDA.
- „ 6. ARANEIDA.
- „ 7. ACARIDA.
- „ 8. XIPHOSURA.
- „ 9. EURYPTERIDA.

Appendix to the Arachnida—The
Pycnogonida, Linguatulida, and
Tardigrada.

PHYLUM XI. MOLLUSCA.

Class I. **PELECYPODA**.

- Order 1. PROTOBRANCHIA.
- „ 2. FILIBRANCHIA.
- „ 3. PSEUDO-LAMELLI-
BRANCHIA.
- „ 4. EULAMELLIBRANCHIA.
- Sub-order *a. Integripalliata*.
- „ *b. Sinupalliata*.
- Order 5. SEPTIBRANCHIA.

Class II. **AMPHINEURA**.

- Order 1. PLACOPHORA.
- „ 2. APLACOPHORA.

Class III. **GASTROPODA**.

- Sub-class I. **Streptoneura**.
- Order 1. ASPIDOBANCHIA.
- Sub-order 1. *Docoglossa*.

Sub-order 2. *Rhipidoglossa*.

Order 2. PECTINIBRANCHIA.

- Sub-order 1. *Platypoda*.
- „ 2. *Heteropoda*.

Sub-class II. **Euthyneura**.

- Order 1. OPISTHOBANCHIA.
- Sub-order 1. *Tectibranchia*.
- „ 2. *Nudibranchia*.
- Order 2. PULMONATA.

Appendix to the Gastropoda—Class

IV. **SCAPHOPODA**.Class V. **CEPHALOPODA**.

- Sub-class 1. **Dibranchiata**.
- Order 1. DECAPODA.
- „ 2. OCTOPODA.
- Sub-class II. **Tetrabranchiata**.

PHYLUM XII. CHORDATA.

SUB-PHYLUM I. **ADELOCHORDA**.Class **ADELOCHORDA**.SUB-PHYLUM II. **UROCHORDA**.Class **UROCHORDA**.

- Order 1. LARVACEA.
- „ 2. THALIACEA.
- Sub-order *a. Cyclomyaria*.
- „ *b. Hemimyaria*.
- Order 3. ASCIDIACEA.
- Sub-order *a. Ascidiæ simplices*.
- „ *b. Ascidiæ compositæ*.

Order 4. LUCIDA.

SUB-PHYLUM III. **EUCHORDA**.Section I. ACRANIA
(CEPHALOCHORDA).

Section II. CRANIATA

(VERTEBRATA).

Class I. **CYCLOSTOMATA**.

- Order 1. PETROMYZONTES.
- „ 2. MYXINOIDEI.

PHYLUM XII. CHORDATA—*continued.*

Class I. **PISCES.**

Sub-class I. **Elasmobranchii.**

- Order 1. CLADOSELACHII.
- „ 2. PLEURACANTHII.
- „ 3. ACANTHODEI.
- „ 4. SELACHII.

- Sub-order *a. Protoselachii.*
- „ *b. Euselachii.*
- Section *α. Squalida.*
- „ *β. Rajida.*

Sub-class II. **Holocephali.**

„ III. **Teleostomi.**

- Order 1. CROSSOPTERYGII.
- „ 2. CHONDROSTEI.
- „ 3. HOLOSTEI.
- „ 4. TELEOSTEI.

- Sub-order *a. Physostomi.*
- „ *b. Anacanthini.*
- „ *c. Acanthopteri.*
- „ *d. Pharyngognathi.*
- „ *e. Plectognathi.*
- „ *f. Lophobranchii.*

Sub-class IV. **Dipnoi.**

- Order 1. MONOPNEUMONA.
- „ 2. DIPNEUMONA.

Appendix to Pisces—The **Ostracodermi.**

- Order 1. HETEROSTRACI.
- „ 2. OSTEOSTRACI.
- „ 3. ANTIARCHA.

Class III. **AMPHIBIA.**

- Order 1. URODELA.
- „ 2. ANURA.
- „ 3. GYMNOPHIONA.
- „ 4. STEGOCEPHALA.

Class IV. **REPTILIA.**

- Order 1. SQUAMATA.
- Sub-order *a. Lacertilia.*
- „ *b. Ophidia.*
- „ *c. Pythonomorpha.*
- Order 2. RHYNCHOCEPHALIA.
- „ 3. CHELONIA.
- „ 4. THEROMORPHA.
- „ 5. CROCODILIA.

Order 6. SAUROPTERYGIA.

- „ 7. ICHTHYOPTERYGIA.
- „ 8. DINOSAURIA.
- „ 9. PTEROSAURIA.

Class V. **AVES.**

Sub-class I. **Archæornithes.**

Sub-class II. **Neornithes.**

Division A. **Ratitæ.**

- Order 1. MEGISTANES.
- „ 2. APTERYGES.
- „ 3. DINORNITHES.
- „ 4. RHEE.
- „ 5. STRUTHIONES.
- „ 6. ÆPYORNITHES.
- „ 7. GASTORNITHES.

Division B. **Carinatæ.**

- Order 1. STEREOORNITHES.
- „ 2. ODONTOLCÆ.
- „ 3. ICHTHYORNITHES.
- „ 4. PYGOPODES.
- „ 5. IMPENNES.
- „ 6. TURBINARES.
- „ 7. STEGANOPODES.
- „ 8. HERODIONES.
- „ 9. ANSERES.
- „ 10. ACCIPITRES.
- „ 11. CRYPTURI.
- „ 12. GALLINÆ.
- „ 13. GRALLÆ.
- „ 14. GAVIÆ.
- „ 15. LIMICOLÆ.
- „ 16. PTEROCLETES.
- „ 17. COLUMBÆ.
- „ 18. PSITTACI.
- „ 19. STRIGES.
- „ 20. PICARLÆ.
- „ 21. PASSERES.

Class VI. **MAMMALIA.**

Sub-class I. **Prototheria.**

„ II. **Theria.**

Section A. **Metatheria** (MARSUPI-
ALIA).

Order 1. POLYPROTODONTIA.

- „ 2. DIPROTODONTIA.

PHYLUM XII. CHORDATA—*continued*.Class VI. MAMMALIA—*cont.*Sub-class II. Theria—*cont.*

Section B. Eutheria.

Order 1. EDENTATA.

.. 2. CETACEA.

Sub-order *a.* *Mystacoceti*... *b.* *Odontoceti*.

Order 3. SIRENIA.

.. 4. UNGULATA.

Section 1. Ungulata vera.

Sub-order *a.* *Perissodactyla*... *b.* *Artiodactyla*.

Section 2. Subungulata.

Sub-order *a.* *Hyracoida*.Sub-order *b.* *Proboscidea*.

Order 5. CARNIVORA.

Sub-order *a.* *Carnivora vera*... *b.* *Pinnipedia*.

Order 6. RODENTIA.

.. 7. INSECTIVORA.

.. 8. CHIROPTERA.

Sub-order *a.* *Megachiroptera*... *b.* *Microchiroptera*.

Order 9. PRIMATES.

Sub-order *a.* *Prosimii*... *b.* *Anthropoidea*.

ZOOLOGY

INTRODUCTION

Zoology, the branch of Natural History which deals with animals, is one of the two subdivisions of the great science **Biology**, which takes cognisance of all *organisms*, or things having life, as distinguished from such lifeless natural objects as rocks and minerals. The second of the two subdivisions of Biology is **Botany**, which deals with plants.

The subject-matter of Zoology, then, is furnished by the animals which inhabit the land-surface, the air, and the salt and fresh waters of the globe: the aim of the science is to find out all that can be known of these animals, their structure, their habits, their mutual relationships, their origin.

The first step in the study of Zoology is the recognition of the obvious fact that the innumerable individual animals known to us may be grouped into what are called **species**, the members of which resemble one another so closely that to know one is to know all. The following example may serve to give the reader a fairly accurate notion of what Zoologists understand by species, and of the method of naming species which has been in use since the time of the great Swedish naturalist Linnæus.

The Domestic Cat, the European Wild Cat, the Ocelot, the Leopard, the Tiger, and the Lion are animals which agree with one another in the general features of their organisation—in the number and form of their bones and teeth, in the possession of retractile claws, and in the position and characters of their internal organs. No one can fail to see that these animals, in spite of differences of size, colour, markings, &c., are all, in the broad sense of the word, “Cats.” This is expressed in the language of systematic Zoology by saying that they are so many **species** of a single **genus**.

According to the system of *binomial nomenclature* introduced by Linnæus, each kind of animal receives two names—one the *generic*

name, common to all species of the genus; the other the *specific name*, peculiar to the species in question. Both generic and specific names are Latin in form, and are commonly Latin or Greek, in origin, although frequently modern names of persons or places, with Latinised terminations, are employed. In giving the name of an animal, the generic name is always placed first, and is written with a capital letter, the specific name following it, and being written, as a rule, with a small letter. For instance, to take the examples already referred to, the Domestic Cat is called *Felis domestica*, the European Wild Cat *F. catus*, the Leopard *F. pardus*, the Tiger *F. tigris*, the Lion *F. leo*. Thus the systematic name of an animal is something more than a mere appellation, since it indicates the affinity of the species with other members of the same genus: to name an animal is, in fact, to classify it.

It is a matter of common observation that no two individuals of a species are ever exactly alike: two tabby Cats, for instance, however they may resemble one another in the general characters of their colour and markings, invariably present differences in detail by which they can be readily distinguished. *Individual variations* of this kind are of universal occurrence. Moreover, it often happens that the members of a species are divisible into groups distinguishable by fairly constant characters: among Domestic Cats, for instance, we find white, black, tabby, gray, and tortoiseshell Cats, besides the large long-haired Persian breed, and the tailless Manx Cat. All these are distinguished as *varieties* of the single species *Felis domestica*.

It is often difficult to decide whether two kinds of animals should be considered as distinct species or as varieties of a single species, and no universal rule can be given for determining this point. Among the higher animals mutual fertility is a fair practical test, the varieties of a species usually breeding freely with one another and producing fertile offspring, while distinct species either do not breed together or produce infertile *hybrids* or mules. Compare, for instance, the fertile mongrels produced by the union of the various breeds of Domestic Dog with the infertile mule produced by the union of the Horse and Ass. But this rule is not without exception, and in the case of wild animals is, more often than not, impossible of application: failing it, the only criterion of a "good species" is usually the presence of constant differences from allied species. Suppose, for instance, that a naturalist receives for description a number of skins of wild Cats, and finds, after an accurate examination, that in some specimens the tail is two-thirds the length of the body and the skin of a uniform reddish tint with a few markings on the head, while in the rest the tail is nearly half as long as the body, and the skin tawny with black stripes. If there are no intermediate gradations between these two sets of individuals, they will be placed without hesitation in distinct

species : if, on the other hand, there is a complete series of gradations between them, they will be considered to form a single variable species.

As, therefore, animals have to be distinguished from one another largely by structural characters, it is evident that the foundations of a scientific Zoology must be laid in **Morphology**, the branch of science which deals with form and structure. Morphology may be said to begin with an accurate examination of the external characters ; the divisions of the body, the number and position of the limbs, the characters of the skin, the position and relations of the mouth, eyes, ears, and other important structures. Next the internal structure has to be studied, the precise form, position, &c., of the various organs, such as brain, heart, and stomach, being made out : this branch of morphology is distinguished as **Anatomy**. And, lastly, the various parts must be examined by the aid of the microscope, and their minute structure, or **Histology**, accurately determined. It is only when we have a fairly comprehensive knowledge of these three aspects of a given animal—its external characters, its rough anatomy, and its histology—that we can with some degree of safety assign it to its proper position among its fellows.

An accurate knowledge of the structure of an animal in its adult condition is not, however, all-sufficient. Nothing has been made more abundantly clear by the researches of the last half-century than that the results of anatomy and histology must be checked, and if necessary corrected, by **Embryology**—*i.e.* by the study of the changes undergone by animals in their development from the egg to the adult condition. A striking instance is afforded by the common Barnacles which grow in great numbers on ships' bottoms, piers, &c. The older zoologists, such as Linnæus, grouped these creatures, along with Snails, Mussels, and the like, in the group Mollusca, and even the great anatomical skill of Cuvier failed to show their true position, which was made out only when Vaughan Thompson, about seventy years ago, proved, from a study of the newly hatched young, that their proper place is among the Crustacea, in company with Crabs, Shrimps, and Water fleas.

Given a sound knowledge of the anatomy, histology, and embryology of animals, their **Classification** may be attempted—that is, we may proceed to arrange them in groups and sub-groups, each capable of accurate definition.

The general method of classification employed by zoologists is that introduced by Linnæus, and may be illustrated by reference to the group of Cats which we have already used in the explanation of the terms genus, species, and variety.

We have seen that the various kinds of true Cat—Domestic Cat, Lion, Tiger, &c.—together constitute the genus *Felis*. Now there

is one member of the cat-tribe, the Cheetah, or Hunting Leopard, which differs from all its allies in having imperfectly retractile claws and certain peculiarities in its teeth. It is therefore placed in a distinct genus, *Cynælurus*, to mark the fact that the differences separating it from any species of *Felis* are of a more fundamental character than those separating the species of *Felis* from one another.

The nearest allies of the Cats are the Hyænas, but the presence of additional teeth and of non-retractile claws—to mention only two points—makes the interval between Hyænas and the two genera of Cats far greater than that between *Felis* and *Cynælurus*. The varying degree of difference is expressed in classification by placing the Hyænas in a separate **family**, the *Hyænida*, while *Felis* and *Cynælurus* are placed together in the family *Felida*. Similarly, the Civets and Mongooses form the family *Viverrida*; the Dogs, Wolves, Jackals, Foxes, &c., the family *Canida*; Bears, the family *Ursida*; and so on.

All the foregoing animals have sharp teeth adapted to a flesh diet, and their toes are armed with claws. They therefore differ fundamentally from such animals as Sheep, Deer, Pigs, and Horses, which have flat teeth adapted for grinding vegetable food, and hoofed feet. The differences here are obviously far greater than those between any two of the families mentioned above, and are emphasised by placing the flesh-eaters in the **order Carnivora**, the hoofed animals in the order *Ungulata*. In the same way gnawing animals, such as Rats, Mice, and Beavers, form the order *Rodentia*; pouched animals, such as Kangaroos and Opossums, the order *Marsupialia*; and so on.

Carnivora, Ungulata, Rodentia, Marsupialia, &c., although differing from one another in many important respects, agree in the possession of a hairy skin and in the fact that they all suckle their young. They thus differ from Birds, which have a covering of feathers and hatch their young from eggs. The differences here are considerably more important than those between the orders of quadrupeds referred to, and are expressed by placing the latter in the **class Mammalia**, while Birds constitute the class *Aves*. In the same way the scaly, cold-blooded Lizards, Snakes, Tortoises, &c., form the class *Reptilia*; the slimy-skinned, scaleless Frogs, Toads, and Salamanders the class *Amphibia*; and the finned, water-breathing Fishes the class *Pisces*.

Mammals, Birds, Reptiles, Amphibians, and Fishes all agree with one another in the possession of red blood and an internal skeleton—an important part of which is an axial rod or vertebral column—and in never having more than two pairs of limbs. They thus differ in some of the most fundamental features of their organisation from such animals as Crabs, Insects, Scorpions, and Centipedes, which have colourless blood, a jointed external skeleton, and

numerous limbs. These differences—far greater than those between classes—are expressed by placing the backboneed animals in the **phylum** or **sub-kingdom** *Chordata*, the many-legged armoured forms in the phylum *Arthropoda*. Similarly, soft-bodied animals with shells, such as Oysters and Snails, form the phylum *Mollusca*, Polypes and Jelly-fishes the phylum *Cocenterata*. And finally the various phyla recognised by zoologists together constitute the KINGDOM *Animalia*.

Thus the animal kingdom is divided into phyla, the phyla into classes, the classes into orders, the orders into families, the families into genera, and the genera into species, while the species themselves are assemblages of individual animals agreeing with one another in certain constant characters. It will be seen that the *individual* is the only term in the series which has a real existence: all the others are mere groups formed, more or less arbitrarily, by man.

To return to the animal originally selected as an example, it will be seen that the zoological position of the Domestic Cat is expressed as follows:—

Kingdom—ANIMALIA.

Phylum—CHORDATA.

Class—MAMMALIA.

Order—CARNIVORA.

Family—*Felidæ*.

Genus—*Felis*.

Species—*F. domestica*.

The object of systematic zoologists has always been to find a *natural* as opposed to an *artificial* classification of animals. Good instances of artificial classification are the grouping of Bats with Birds on the ground that they both possess wings, and of Whales with Fishes on the ground that they both possess fins and live in the water. An equally good example of a natural classification is the grouping of both Bats and Whales under the head of Mammalia because of their agreement, in all essential points of anatomy, histology, and embryology, with the hairy quadrupeds which form the bulk of that class.

With the older zoologists the difficulty was to find some general principle to guide them in their arrangement of animals—some true criterion of classification. It was believed by all but a few advanced thinkers that the individuals of each species of animal were descended from a common ancestor, but that the original progenitor of each species was totally unconnected with that of every other, having, as Buffon puts it, “participated in the grace of a distinct act of creation.” To take an instance—all Wolves were allowed to be descended from a pair of ancestral Wolves, and all Jackals from a pair of ancestral Jackals, but the original pair in each case was supposed to have come into being by a supernatural

process of which no explanation could or ought to be offered. Nevertheless it was obvious that a Jackal was far more like a Wolf than either of them was like a Tiger, and that in a natural system of classification this fact should be expressed by placing the Wolf and Jackal in one family, the Tiger in another.

All through the animal kingdom the same thing occurs: no matter what group we take, we find the species composing it resemble one another in varying degrees, or, as it is sometimes expressed, have varying degrees of *relationship* to one another. On the view that each species was separately created the word relationship was used in a purely metaphorical sense, as there could of course be no real relationship between two groups of animals having a totally independent origin. But it was assumed that creation had taken place according to a certain scheme in the Divine Mind, and that the various species had their places in this scheme like the bits of glass in a mosaic. The problem of classification was thus to discover the place of each species in the pattern of the unknown design.

The point of view underwent a complete change when, after the publication of Darwin's *Origin of Species* in 1859, the **Doctrine of Descent** or of **Organic Evolution** came to be generally accepted by biologists. A species is now looked upon, not as an independent creation, but as having been derived by a natural process of descent from some pre-existing species, just as the various breeds of Domestic Fowl are descended from the little Jungle-fowl of India. On this view the resemblances between species referred to above are actually matters of relationship, and species are truly allied to one another in varying degrees since they are descended from a common ancestor. Thus a natural classification becomes a genealogical tree, and the problem of classification is the tracing of its branches.

This, however, is a matter of extreme difficulty. Representing by a tree the whole of the animals which have ever lived on the earth, those existing at the present day would be figured by the topmost twigs, the trunk and main branches representing extinct forms. Thus the task of arranging animals according to their relationships would be an almost hopeless one but for two circumstances: one, that remains of many extinct forms have been preserved; the other, that the series of changes undergone by an animal in its development from the egg sometimes appears to afford an indication of the changes by which, in the course of ages, it has been evolved from an ancestral type. Evidence furnished by the last-named circumstance is, of course, furnished by embryology: the study of extinct animals constitutes a special branch of morphology to which the name **Palæontology** is applied.

The solid crust of the earth is composed of various kinds of rocks divisible into two groups: (1) *Igneous rocks*, such as granite

and basalt, the structure of which is due to the action of the internal heat of the globe, and which originate below the surface and are not arranged in layers or strata ; (2) *Aqueous* or *sedimentary rocks*, which arise by the disintegration, at the surface of the earth, of pre-existing rocks, the fragments or débris being carried off by streams and rivers and deposited at the bottom of lakes or seas. Being formed in this way by the deposition of successive layers or strata, the sedimentary rocks have a *stratified* structure, the lowest being in every case older than the more superficial layers. The researches of geologists have shown that there is a general *order of succession* of stratified rocks : that they may be divided into three great *groups*, each representing an *era* of time of immense but unknown duration, and that each group may be subdivided into more or fewer *systems* of rocks, each representing a lesser *period* of time. The following table shows the thirteen rock-systems usually recognised, arranged under the three great groups in chronological order, the oldest being at the bottom of the list.

III. Cainozoic or Tertiary . .	}	13. Quaternary and Recent.
		12. Pliocene.
		11. Miocene.
		10. Eocene.
II. Mesozoic or Secondary .	}	9. Cretaceous.
		8. Jurassic.
		7. Triassic.
I. Palæozoic or Primary . .	}	6. Permian.
		5. Carboniferous.
		4. Devonian.
		3. Silurian.
		2. Cambrian.
		1. Laurentian.

Imbedded in these rocks are found the remains of various extinct animals in the form of what are called *fossils*. In the more recent rocks the resemblance of these to the hard parts of existing animals is perfectly clear : we find shells hardly differing from those we pick up on the beach, bones easily recognisable as those of Mammals, Birds, or Fishes, and so on. But in the older rocks the fossils are in many cases so different in character from the animals existing at the present day as to be referable to no existing order. We find Birds with teeth, great aquatic Reptiles as large as Whales, Fishes, Molluses, Crustacea, &c., all of an entirely different type from any now existing. We thus find that the former were in many cases utterly unlike the present animal inhabitants of the globe, and we arrive at the notion of a *succession of life in time*, and are even able, in exceptionally favourable circumstances, to trace back existing forms to their extinct ancestors.

By combining the results of comparative morphology, embryology,

and palæontology we get a department of Zoology called **Phylogeny**, the object of which is to trace the pedigrees of the various groups. There are, however, very few cases in which this can be done with any approach to exactness: most "phylogenies" are purely hypothetical, and merely represent the views at which a particular zoologist has arrived after a more or less exhaustive study of the group under discussion.

Animals may also be studied from the point of view of **Distribution**. One aspect of this study is inseparable from Palæontology, since it is obviously necessary to mention in connection with a fossil the particular system or systems of rocks in which it occurs: thus we distinguish **geological distribution** or **distribution in time**.

The distribution of recent forms may be studied under two aspects, their **horizontal** or **geographical distribution**, and their **vertical** or **bathymetrical distribution**. To mention the latter first, we find that some species exist only on plains, others—hence called *alpine forms*—on the higher mountains; that some marine shells, fishes, &c., always keep near the shore (*littoral* species), others live at great depths (*abyssal* species), while others (*pelagic* species) swim on the surface of the ocean. Among aquatic animals, moreover, whether marine or fresh-water, three principal modes of life are to be distinguished. There are animals, such as Jelly-fishes, which float on or near the surface of the water, and are carried about passively by currents: such forms are included under the term *Plankton*. Most Fishes, Whales, and Cuttle-fishes, on the other hand, are strong swimmers, and are able to traverse the water at will in any direction; they together constitute the *Nekton*. Finally, such animals as Crabs, Oysters, Sponges, Zoophytes, &c., remain permanently fixed to or creep over the surface of the bottom, and are grouped together as the *Benthos*.

Under the head of geographical distribution we have such facts as the absence of all Land-mammals, except Bats, in New Zealand and the Polynesian Islands, the presence of pouched Mammals, such as Kangaroos and Opossums, only in some parts of America and in Australia and the adjacent islands, the entire absence of Finches in Australasia, and so on. We find, in fact, that the *fauna*—i.e. the total animal inhabitants—of a country is to a large extent independent of climate, and that the faunæ of adjacent countries often differ widely. In fact, it is convenient in studying the geographical distribution of animals largely to ignore the ordinary division into continents, and to divide the land-surface of the globe into what are called *zoo-geographical* regions. The characteristics of these regions will be discussed in a future section; at present it is only necessary, for convenience of reference, to give their names and boundaries.

1. The *Holarctic Region* includes the whole of Europe, Asia as far south as the Himalayas, Africa north of the Sahara, together with the corresponding portion of Arabia, and North America as far south as Mexico. For convenience of reference it is often customary to divide this region into two: its Eurasian portion is then called the *Palaearctic*, its American portion the *Nearctic* region.

2. The *Ethiopian Region* includes Africa south of the Sahara, Southern Arabia, and Madagascar with the adjacent islands.

3. The *Oriental Region* includes India, Ceylon, South China, the Malayan Peninsula, and what are known as the Indo-Malayan islands, *i.e.* those islands of the Malayan Archipelago which lie to the west of a line—called *Wallace's line*—passing to the east of the Philippines, between Borneo and Celebes and between Bali and Lombok.

4. The *Australian Region* includes Australia, Tasmania, and the Austro-Malayan islands, *i.e.* the islands of the Malayan Archipelago lying to the east of Wallace's line.

5. The *New Zealand Region* includes New Zealand and the adjacent islands, such as the Chatham, Auckland, and Campbell groups.

6. The numerous groups of islands lying between Australia and Southern Asia to the west, and America to the east, are conveniently grouped together as the *Polynesian Region*.

7. The *Neotropical Region* includes the whole of South and Central America and part of Mexico.

There are still two departments of zoological science to be mentioned. As it is impossible to have a right understanding of a machine without knowing something of the purpose it is intended to serve, so the morphological study of an animal is imperfect without some knowledge of its **Physiology**, *i.e.* of the functions performed by its various parts, and the way in which they work together for the welfare of the whole. It is hardly possible to give more than occasional references to physiological matters in a text-book of Zoology, but in order to pave the way for such references a brief account of the general principles of Physiology will be given in the next section.

Not only may we study the action of a given animal's organs, but also the actions of the animal as a whole, its habits, its relations to other animals—whether as friends, as enemies, or as prey, to the vegetable kingdom, and to its physical surroundings, such as temperature, humidity, &c. In a word, the whole question of the relation of the *organism* to its *environment* gives us a final and most important branch of Natural History which has been called **Ethology** or **Bionomics**.

SECTION I

THE GENERAL STRUCTURE AND PHYSIOLOGY OF ANIMALS

I. AMOEBA.

IF we examine under the microscope a drop of water containing some of the slimy deposit which collects at the bottom of pools of rain-water and in similar situations, we occasionally find it to abound in microscopic life ; and among the minute moving creatures in such a drop we frequently find examples of a remarkable organism—the *Amœba* or Proteus Animalcule (Fig. 1). This is

a little particle of irregular shape, which we should be likely, on a cursory examination, to put down as motionless ; it appears somewhat like an irregular particle of some colourless glass-like substance with a more granular central portion. If, however, we make an exact drawing of the outline of the *Amœba*, and, after an interval, compare the drawing with the original, we find that the drawing appears no longer to represent what we see ; a change has taken place in the shape of the *Amœba* ;

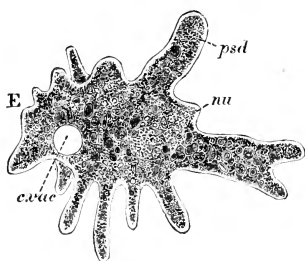

FIG. 1.—*Amœba proteus*, a living specimen.
c. vac., contractile vacuole ; *nu.*, nucleus ;
psd., pseudopods. (From Parker's *Biology*,
after Gruber.)

and careful observation shows that this change is constantly going on : the *Amœba* is constantly varying in shape. This change is effected by the pushing out of projections or processes, called pseudopods (*psd.*), which undergo various alterations of size and shape, and may become withdrawn, other similar processes being developed in their place. At the same time careful watching shows that the *Amœba* is also, with extreme slowness,

changing its *position*. This it effects by a kind of streaming motion. A projection forms itself on one side, and the entire substance of the Amœba gradually streams into it; a fresh projection appears towards the same side, the streaming movement is repeated, and, by a constant succession of such movements, an extremely gradual locomotion, which it often takes very close watching to detect, is brought about. In these movements, it is to be noticed, the Amœba is influenced to some extent by contact with other minute objects; when the processes come in contact with small grains of sand or other similar particles their movements are modified in such a way that the Amœba, in its slow progress onwards, passes on one side of them, so that it might be said to feel its way among the solid particles in the drop of sediment. Experiments show that the direction of its movements is capable of being influenced from without by other agencies—by light and heat, for example. So that we are led to conclude that Amœba has a fairly wide range of *irritability* or sensitiveness to external influences or environment.

Judging from the nature of these movements, we are obliged to infer that the substance of which this remarkable object is composed must be soft and semi-fluid, yet not miscible with the water, and, therefore, preserving a sharp contour. The more or less fluid character is evidenced not only by the nature of the movements, but also by the facts that the clear spaces in the interior to be presently noticed assume a rounded shape, and that if the Amœba be broken up, as it may be by pressure on the cover-glass, the fragments become rounded off into droplets. These and other characteristics to be mentioned subsequently enable us to conclude that we have to do with the substance of complex chemical composition termed *protoplasm*, which constitutes the vital material of all living organisms whether animals or plants. In Amœba the protoplasm is in many cases clearly distinguishable into two parts, an outer homogeneous, glassy-looking layer (*exoplasm*) completely enclosing a more granular internal mass (*endoplasm*).

Examination of the Amœba with a fairly high power of the microscope reveals the presence in its interior of two objects which with a low power we should be likely to overlook. One of these is a small rounded body with well-defined contour, which preserves its form during all the changes which the Amœba as a whole undergoes. This is termed the *nucleus* (Fig. 1, *nu.*); it is enclosed in an extremely delicate membrane, and contains a protoplasmic material differing from that which forms the main bulk of the Amœba in containing a substance which refracts the light more strongly and which has a stronger affinity for certain colouring matters. The other minute object to be distinguished in the interior appears as a clear rounded space (*c. vac.*) in the protoplasm, or several spaces which subsequently coalesce into one.

When this is watched it will be observed to increase gradually in size till it reaches a maximum of, let us say, a fifth of the total diameter of the Amœba, when, by a contraction of its walls, it suddenly disappears, to reappear presently and gradually grow again to its maximum size. This pulsating clear space is the *contractile vacuole*. Other clear spaces which do not pulsate are the *non-contractile vacuoles*.

By watching the Amœba carefully for some time we may be enabled to observe that the movements of the protoplasm of the body not only effect locomotion, but are connected also with the reception of certain foreign particles of organic nature—*i.e.* either entire minute animals or plants, or minute fragments of larger forms—into the interior of the protoplasm. A process of the protoplasm is pressed against such a particle, which becomes sunk in the soft substance, and passes gradually into the interior. Here it becomes enclosed in one of the non-contractile vacuoles, and by degrees partially or wholly disappears; the part, if any, which remains subsequently passes outwards from the protoplasm into the surrounding water. The matter which disappears evidently mixes with the protoplasm and adds to its bulk. All, in fact, of the matter of the foreign body that is capable of doing so, becomes digested and assimilated by the protoplasm. The fluid in the vacuole enclosing the food-particle (for such is the true nature of the foreign body) probably contains some ingredient of the nature of a *ferment*, which is able to act on certain substances and render them more soluble or capable of being more readily taken up by the protoplasm. This we infer mainly from what we know of the digestion and absorption of food in the higher animals; but the fact, which has been established by experiment, that the Amœba is able readily to digest certain classes of organic substances, while others, when taken into the interior of the protoplasm, remain unaltered, seems to indicate that some special property, similar to those possessed by the digestive ferments of the higher animals, is present in the watery fluid surrounding the food-particle.

The movements of the Amœba, slow and gradual though they are, must involve a certain expenditure of energy or working power; this can only be derived from the energy of *chemical affinity* which the protoplasm possesses in virtue of its complex chemical composition. The protoplasm loses some of this energy by its conversion into energy of movement. This loss implies the breaking up of the complex chemical ingredients of which protoplasm is composed into simpler ones; the protoplasm falls a grade in the scale of chemical compounds, and by its fall generates the force by means of which the Amœba moves. The energy of chemical affinity which the protoplasm possesses is thus analogous to the potential energy which the weight of a clock has when it is wound up. As the weight, by virtue of its position, is able as it

falls to deal out working power so as to cause the movement of the machinery of the clock, so the protoplasm is able, by the degradation or decomposition of its complex compounds, to deal out working power enabling the *Amœba* to move. In the case of the clock-weight there comes a time when all the potential energy is expended; the weight reaches its lowest limit, and unless it is wound up again the clock stops. The like holds good of the *Amœba*; the protoplasm is continually being used up—decomposed into compounds of a lower order—and, in course of time, the whole potential energy would become exhausted, were it not that a new supply is being constantly received. This new supply of energy is derived from the substance of the food-particles; and this at the same time maintains the *bulk* of the *Amœba*, which, if food-particles are absent from the water, gradually diminishes.

Accompanying the degradation, or *destructive metabolism* or *catabolism* as it is termed, of the protoplasm, and intimately connected with it, is the passage inwards of oxygen from the air dissolved in the water, and the passage outwards of carbonic acid gas (carbon dioxide). Oxygen is a necessary agent in the process of destructive metabolism, and carbonic acid is a constant waste-product of such action. This interchange of oxygen and carbonic acid is the essence of the process of *respiration* observable in all living things. When *Amœbæ* are placed in water from which all atmospheric oxygen has been removed, all movement soon becomes arrested, the pseudopods become withdrawn, the body becoming rounded off and enclosed in a thin covering or *cyst*, and if the deprivation is made to last long enough death and disintegration follow. Similar results follow the presence of excess of carbon dioxide in the water. In such an environment the *Amœba* is unable to get rid of the carbon dioxide which it is itself producing, and becomes poisoned by the accumulation.

In addition to the carbonic acid given off in this process, other waste-products are formed and have to be got rid of. In all probability the *contractile vacuole* already referred to has to do with this process—the process of *excretion*—since *uric acid*, which in higher animals is the typical form assumed by such waste-products, is said to have been detected in the interior of the contractile vacuole in the case of certain near relatives of *Amœba*.

When food is abundant the *Amœba* increases in bulk—more food being ingested than is required for simply maintaining the size unaltered—and soon a remarkable change takes place. The processes are withdrawn, and a fissure appears dividing the *Amœba* into two parts (Fig. 2). This fissure grows inwards, and the two parts become more and more completely separated from one another, till eventually the separation is complete, and we have two distinct *Amœbæ* resulting from the division of the one. While the protoplasm has been undergoing this division into

halves the nucleus has also divided, and each of the two new *Amœbæ* possesses a nucleus similar to the original one, and developed from it by division. It is mainly by this simple process of division into two, or *binary fission* as it is called, that *reproduction* or multiplication takes place in the *Amœba*.

In spite of the great simplicity of its structure, the *Amœba* thus carries on a number of different functions. The practically structureless particle of protoplasm is able to act on matter absorbed as food in such a way as to alter the chemical composition of the latter and to assimilate it; it is able to carry on movements

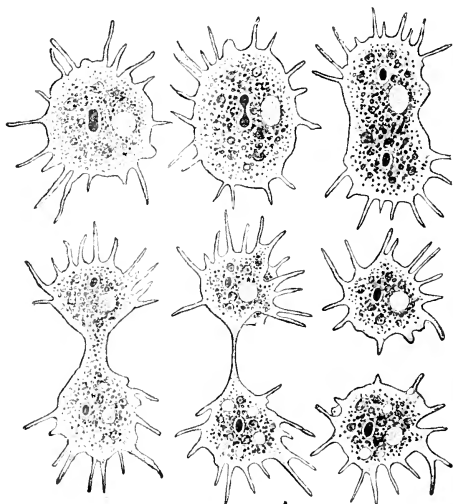

FIG. 2.—*Amœba polypodia* in successive phases of division. The light spot is the contractile vacuole; the dark the nucleus. (From Laug's *Text-Book*, after F. E. Schulze.)

of locomotion, as well as movements—those involved in the taking in of food-particles—which may be looked upon as movements of prehension; it exhibits a certain degree of sensitiveness or irritability, as shown by the modifications of its movements which result from contact with foreign bodies; it is able to respire; it carries on processes of excretion; and, finally, it is capable of reproducing its kind. It is these functions that characterise *living* beings as distinguished from *non-living* matter. What is specially characteristic of the living organism in general when compared with a non-living object is the capacity of the former to respond by changes in itself to influences operating on

it from without. In the case of such an extremely simple organism as *Amœba*, these changes are also, necessarily, extremely simple; but they are of a quite definite character. In addition to the effects produced on its actions by mechanical obstacles and the presence of food-particles, *Amœba* responds by definite changes in itself to such external influences as changes in the amount of oxygen supplied, in the quantities of various salts present, in the temperature, and in the electric conditions of the water in which it lives. The power of locomotion, the capacity for assimilating organic substances, and the absence of two special compounds—*chlorophyll* and *cellulose*—are specially characteristic of the animal as distinguished from the plant.

In connection with these vital processes of *Amœba* the nucleus plays an important rôle. If an *Amœba* be cut in two, the part containing the nucleus continues to comport itself like a normal complete animal; it continues to take in and digest food, and eventually recovers its original size. The non-nucleated part, on the other hand, though it may continue to live for a good many days, is unable to absorb nourishment; its movements lack co-ordination and do not respond to stimuli in the normal way. Eventually death takes place in about ten to thirty days as a result, apparently, of the exhaustion of the store of potential energy—the processes of destructive metabolism having continued without the compensating processes of nutrition and assimilation.

It has already been stated that an *Amœba* may be killed by being subjected to excess of carbon dioxide. If this action takes place gradually the *Amœba* is able to withdraw its pseudopods and assume the defensive, motionless, encysted state, in which it is able better to resist unfavourable conditions. But there are many poisons which cause more rapid, even instantaneous, disintegration. Others cause immediate death without much alteration and by their use it is possible to *fix* the *Amœba* in such a way as to retain its structure not greatly altered and preserve it permanently.

2. THE ANIMAL CELL.

In all but the lowest animals the various functions just enumerated are carried on by means of a more or less complex machinery of organs—*muscles*, *alimentary* or *enteric canal*, *glands*, *heart* and *blood-vessels*, *gills* or *lungs*, *nervous system*, *organs of excretion*, and *organs of reproduction*. But in all animals, however complex, the same substance, *protoplasm*, which in *Amœba* constitutes the bulk of the body, is the essential and active part. Wherever in the body active functions are being discharged and active changes are going on, there we find protoplasm present; where there is no protoplasm there is no vital activity. In the earliest stages of

their existence all animals are formed entirely of protoplasm. Every animal consists at first of a single minute particle of protoplasm, not widely different from an *Amœba*. Soon this particle divides into a number of parts which, instead of separating completely from one another, like the parts of a divided *Amœba*, remain associated together, forming a clump of minute particles of protoplasm. Such minute protoplasmic particles are termed *cells*: every animal consists, at first, of a single cell, and afterwards, in all higher animals, this single cell becomes converted by division and subdivision into a little cluster or clump of cells.

It is time that we should inquire more particularly into the meaning of these two terms—cell and protoplasm—evidently so important in the study of both plants and animals. **Protoplasm**, we have already seen, is a semi-fluid, clear or finely granular substance of complex chemical composition. It is known

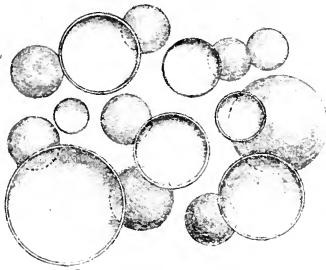

FIG. 3.—Diagram to illustrate the alveolar theory of protoplasm. (After Dahlgren and Kepner.)

not to be a definite compound, but to be a somewhat varying mixture of chemical compounds, the most essential of which are bodies of the class of *proteids*—highly complex substances, into the composition of which the elements carbon, hydrogen, oxygen, nitrogen, and sulphur all enter. Living protoplasm always contains a large amount of water. It is capable in the living condition of passing from the viscid or semi-fluid condition into a gelatinous one in the whole or in parts of a cell. It is soluble in weak acids and weak alkalies; and is capable of being coagulated—rendered firmer and more opaque—by the action of heat and of strong alcohol. Its reaction is slightly alkaline. As regards its minute structure, it is generally acknowledged that there are two kinds of substance in the protoplasm, in some cases more, in others less, distinctly marked off from one another. One of these kinds of material is apparently of less fluid consistency than the other. According to one view (alveolar theory) the two kinds are intimately combined in the form of an emulsion or froth, the one forming the minute vesicles or bubbles in the froth, the other the ground-substance in which the bubbles are embedded (Fig. 3). According to another view (reticular theory), one of these substances, the less fluid, appears to be arranged in the form of a network of threads, composed of numerous minute rounded granules enclosing

not to be a definite compound, but to be a somewhat varying mixture of chemical compounds, the most essential of which are bodies of the class of *proteids*—highly complex substances, into the composition of which the elements carbon, hydrogen, oxygen, nitrogen, and sulphur all enter. Living protoplasm always contains a large amount of water. It is capable in the living condition

the second, more fluid substance in its meshes (Fig. 4). Apparently both of these types of structure occur in the protoplasm in different cases, sometimes even in intimate association.

To a particle of protoplasm, typically containing a nucleus in its interior, constituting the entire body of such a simple organism as *Amœba*, and forming one of the constituent elements of which a higher plant or animal is made up, the term **cell** is applied. The word was first employed in reference to the microscopic structure of plants, in connection with which it is much more appropriate than in connection with the microscopic structure of animals; for a plant-cell has, nearly always, a definite, firm, enclosing envelope or *cell-wall* (Fig. 5, I, *c.w*)—a structure which is only exceptionally present in the case of animals. In the interior of the cell-protoplasm, or *cytoplasm*, is a body termed the *nucleus*, similar to the nucleus of *Amœba*, and usually of rounded shape, with the appearance of being enclosed in a thin *nuclear membrane* (*A, nu.m*), perforated by numerous minute apertures. The nucleus contains a very complex protoplasmic material termed *chromatin*, which differs from the cytoplasm in its strong affinity for certain dyes or staining agents and also in containing phosphorus. Chromatin is shown, by its universal occurrence

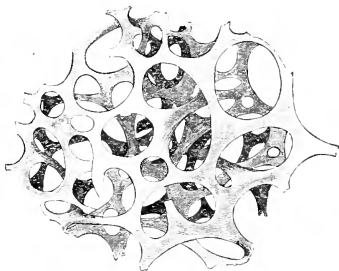

FIG. 4.—Diagram to illustrate the reticular theory of protoplasm. (After Dahlgren and Kepner.)

and its persistence throughout the changes which the cell undergoes, to be the most essential constituent of the nucleus.

In addition to the chromatin the nucleus contains *linin*, *nuclear sap*, and *plastin*. The linin is of the same character as the reticular or alveolar cytoplasm, and the nuclear sap corresponds to the more watery portions of the latter. The plastin is related to chromatin with regard to affinity to staining agents, but differs from it definitely in that and other respects. The arrangement of these constituents of the nucleus differs greatly in different nuclei and in the same nucleus in different phases. The chromatin, in the resting condition of the nucleus, *i.e.* when cell-division is not in progress, may be distributed as granules throughout, with, or more rarely without, a definite relationship with the reticulum or alveoli. In a typical resting nucleus the chromatin granules, or *chromioles*, are strung along the threads of the linin reticulum or in the interspaces between the alveoli so that the chromatin in a stained nucleus stands out as a conspicuous network. But in the nuclei of many unicellular

animals the chromatin is all concentrated in a relatively large central mass with or without other smaller aggregations, or in several, sometimes many, granules of about equal size. The plastin is usually collected together in a rounded mass—the *nucleolus* or *plasmosome*—which may contain some chromatin.

When the nucleus divides during the process of division of the cell, its contents, more particularly the chromatin, in most cases,

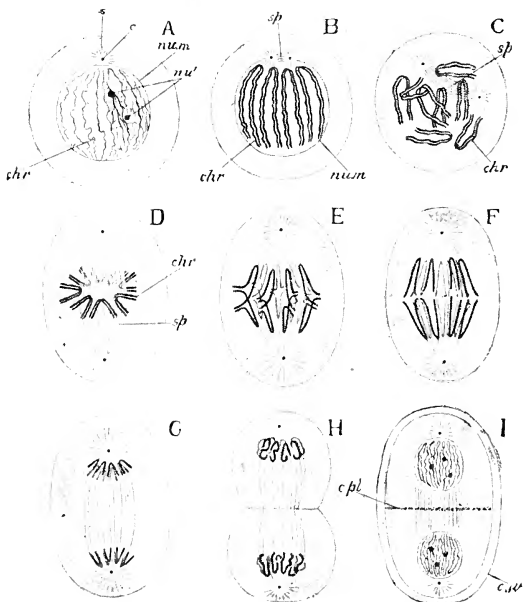

FIG. 5.—Diagrams illustrating karyokinesis. *A*, the resting cell, *B*, *C*, *D*, successive phases in the formation and arrangement of the chromatin loops and of the nuclear spindle; *E*, *F*, *G*, separation of the two sets of daughter-chromosomes and their passage towards the poles of the spindle; *H*, *I*, division of the cell-body and formation of the two new nuclei; *c*, centrosome; *chr.* chromatin; *c. pl.* cell-plate; *nu.* nucleoli; *nu. m.* nuclear membrane; *s*, astrosphere; *sp.* spindle. (From Parker's *Biology*, after Flemming, Rabl, &c.)

go through a remarkable series of changes, to which the term *karyokinesis* or *mitosis* is applied. At the time when this *mitotic division* is about to be initiated, either one or two minute bodies (Fig. 5, *A*, *c*) are to be distinguished situated close together in the cytoplasm in the immediate neighbourhood of the nucleus. When only one of these bodies is present at the outset it subsequently becomes divided into two. These are the *centrosomes*—minute masses of a specially modified protoplasmic substance, capable of

being rendered conspicuous by certain staining agents, surrounded by a light zone. The centrosomes, at first close together, gradually separate from one another, a spindle-shaped bundle of very fine fibres of achromatic¹ material—the *nuclear spindle*—extending between them (Fig. 5, C). At the same time, or at an earlier stage, each centrosome has become the centre of a system of fine achromatin fibres (apparently made up, like the fibres of the spindle, of rows of granules) which are arranged round it in a radiating manner, forming a structure termed the *attraction-sphere* or *astrosphere* (Fig. 5, A, s). Meantime important changes have been in progress in the nucleus. The linin network with its attached chromatin granules or *chromioles* first becomes arranged in a close tangle (*spireme*), and then becomes divided up in a very definite and orderly manner into a number of parts—the *chromatin segments* or *chromosomes*—which frequently have the form of loop-like threads (Fig. 5, B, C, *chr*), but often assume other forms. The number of chromosomes varies, but is constant throughout the cells of the same species of animal. The nuclear membrane disappears. Each of the chromatin segments splits lengthwise into two parts—the *daughter-segments* of the chromatin or *daughter-chromosomes* (Fig. 5, B—D), and with these the filaments of the spindle become connected.

At this point the segments of the chromatin form a single group—the *equatorial plate*—extending across the axis of the spindle. The latter has shifted its position, so that its fibres now run across the original site of the nucleus. Each daughter-segment of the chromatin now separates from its fellow, so that two groups are formed, each containing a similar number of chromosomes. The two groups then move apart from one another, each approaching the corresponding end or pole of the spindle with its centrosome (Fig. 5, E—G). How this movement is effected is not definitely known; it has been supposed that it is due to the contraction of spindle-fibres attached to the centrosomes; but since there is no appearance of the fibres shortening or thickening, it is unlikely that this can be the true explanation.

When the groups have approached the extremity of the spindle, the segments of each unite, and eventually the entire chromatin of each of the two groups assumes the arrangement which the chromatin of the original nucleus exhibited before division began. A new nuclear membrane becomes formed around each chromatin group, and the whole assumes the character of a complete nucleus—the *daughter-nucleus* (Fig. 5, II, I). It is of importance to note that, though in this mitotic division of the nucleus of the animal cell the centrosomes are so conspicuous that it

¹ The term *achromatin* is usually applied to all the matter of the *nucleus* that has not the special characteristics of chromatin; but it applies to *cytoplasmic* structures—i.e. structures belonging to the body of the cell—as well.

would appear as if they had an important share in controlling the process, yet mitosis takes place during cell-division of the higher plants on the same general lines as in animals, though centrosomes have rarely, if ever, been observed in plants higher than the Mosses.

A furrow which appears on the surface of the cell-protoplasm (Fig. 5, *H, I*), surrounding it in the form of a ring in a plane at right angles to the long axis of the spindle, deepens gradually so as to give rise to a cleft, eventually completely separating the substance of the cell into two halves. Each of these halves encloses one of the daughter-nuclei, and has assumed the character of a complete *daughter-cell*. During this process there is sometimes distinguishable along the line corresponding to the division line between the two cells a narrow septum composed of thickenings of the fibres of the spindle; this is known as the *cell-plate* (*I., c.pl.*). But a cell-plate is not of general occurrence in the division of the animal cell.

In some instances the division of the nucleus is *direct* or *amitotic*, the nucleus simply becoming separated into two equal parts, without disappearance of the nuclear membrane and without any complicated re-arrangement of the chromatin.

In many of the Protozoa the nucleus in certain conditions gives off parts of its substance, which pass into its cytoplasm as independent chromatin bodies, the *chromidia*, which may give rise to new nuclei. The chromatin masses in chromidia are distinguished as the *chromidiosomes*.

3. THE OVUM: MATURATION, IMPREGNATION, AND SEGMENTATION: THE GERMINAL LAYERS.

Amœba is simply an independent animal cell; or, to express the same meaning in another way, is a unicellular animal, and as such it is a member of the phylum of the *Protozoa* or unicellular animals. All the rest of the animal kingdom, forming the division *Metazoa*, are *multicellular* in the fully developed condition; but each of these multicellular animals or Metazoa originates from a single cell—the *ovum*. The ovum is a typical cell (Fig. 6), usually spherical in shape, with one or more enclosing membranes, with cell-protoplasm enclosing a nucleus (*germinal vesicle*) in which are contained one or more rounded nucleoli (*germinal spot* or *spots*). The ovum usually contains in addition to the protoplasm a quantity of non-protoplasmic nutrient material or *yolk*.

Before the process of impregnation or fertilisation which gives the impulse to development, the ovum undergoes a change which is termed *maturation* (Fig. 7, *A*). This consists, in essence, of the throwing out of portions of the nucleus. The latter approaches the surface and divides, mitotically, into two parts—one coming to project on the surface and finally the projection being

completely separated off from the ovum as a rounded particle—the *first polar body* (*pol.*). A second division of the nucleus results in the throwing off of a *second polar body*; and, after this has been formed, the portion which remains in the ovum resumes its central position and forms what is termed the *female pronucleus* (*B*, ♀ *pron.*). The essential ultimate result of maturation is the reduction of the number of chromosomes in the ovum by one-half.

In the process of **impregnation** a very minute body, the *male cell*, *sperm-cell*, or *sperm*, penetrates into the interior of the female cell or *ovum*, and the nucleus which it contains—the *male pronucleus* (*C*, ♂ *pron.*)—coalesces with the female pronucleus to form a single nucleus called the *segmentation nucleus* (*E*, *seg. nucl.*).¹ The principal part in the process of fertilisation is thus played by the two nuclei. The female centrosome disappears: a male centrosome enters with the sperm.

Apparently in this process of fertilisation some attraction is operative between the male and female cells. In many instances a prominence (the *receptive prominence*) is pushed out by the ovum at the point where the sperm enters. The female pronucleus, leaving its former central position, approaches the male cell as it enters. In most cases a single sperm alone enters the ovum in impregnation. According to the older observers, as soon as a sperm enters the ovum, a membrane is formed

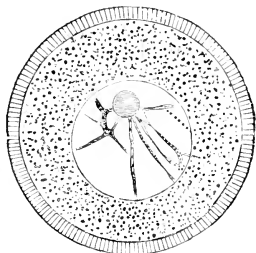

FIG. 6.—Ovum of a Sea-Urchin, showing the radially striated cell-membrane, the protoplasm, containing yolk-granules, the large nucleus (germinal vesicle), with its network of chromatin and a large nucleolus (germinal spot). (From Balfour's *Embryology*, after Hertwig.)

around the latter hindering the penetration of additional sperms; but it has now been shown that such a membrane occurs only in certain cases, and is quite exceptional. That, as a general rule, only one sperm penetrates into the ovum appears to be due to the circumstance that, as a result of the entry of the one sperm, the peculiar attraction above referred to becomes in some way destroyed or diminished. But, though the entry of one sperm only is usual, cases of the entry of several—*polyspermy*, as it is termed—are by no means rare, and would appear to be quite normal in some groups of animals.

In some animals the ovum develops *parthenogenetically*—*i.e.* without any process of fertilisation by means of a male cell. This

¹ In this coalescence the chromosomes of the male and female pronuclei do not become fused, but remain quite separate and retain their distinctness during the nuclear divisions that follow.

is a normal phenomenon in certain families of insects, for example. In a considerable number of marine invertebrate animals it has been shown that though *gamogenesis*, *i.e.* development as the result of fertilisation of ovum by male cell, is the normal process, yet parthe-

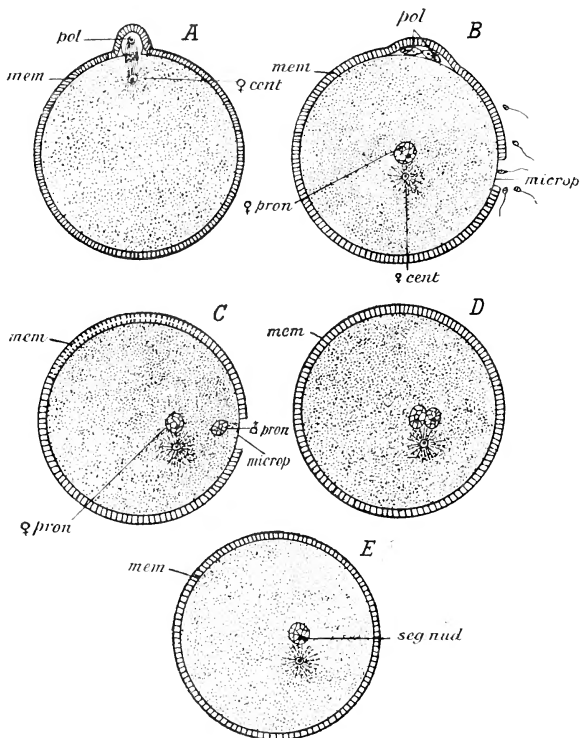

FIG. 7.—Diagram illustrating the maturation and fertilisation of the ovum. *A*, formation of first polar body; *B*, beginning of fertilisation, sperms approaching the micropyle; *C*, formation of the male pronucleus; *D*, approximation of the male and female pronuclei; *E*, formation of segmentation-nucleus; ♀ cent. female centrosome; ♂ cent. male centrosome; mem. egg-membrane; microp. micropyle; pol. polar bodies; ♀ pron. female pronucleus; ♂ pron. male pronucleus; seg. nucl. segmentation nucleus.

nogenesis can be produced by various artificial means. By adding various salts to the water in which the ova are contained, by changes of temperature, or by subjection to the action of carbonic acid gas, the ova, in the absence of sperms, may be caused to give rise to

normal embryos. Such experiments on *artificial parthenogenesis*, as it is termed, show that the entry of a male cell into the ovum is not necessary for the development of the embryo even in cases in which gamogenesis is normal; but that other exciting influences may bring about the same result.

Though, as stated above, the female pronucleus, under normal circumstances, plays so important a rôle in the development, it has been shown that it can be dispensed with. When unfertilised ova of a sea-urchin are broken up, and fragments devoid of nuclei are placed in water along with sperms, the fragments may be fertilised; and, the nucleus of the sperm taking the place of the segmentation-nucleus, normal young, differing from those produced in the usual manner only in their smaller size, may be developed. This phenomenon is known as *merogony*.

The result of fertilisation is the formation of the *impregnated ovum*, or *oosperm* as it is called. The oosperm, it is to be noted, before development begins, consists in general of the primary ovum *minus* the portions of the substance of its nucleus removed

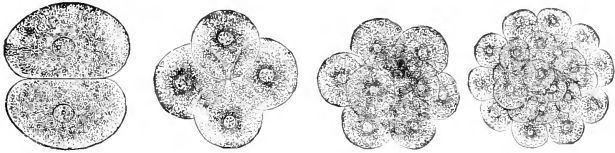

FIG. 8.—Various stages in the segmentation of the ovum. (From Gegenbaur's *Comparative Anatomy*.)

in the polar bodies and also *minus* its centrosome, and *plus* the sperm with its nucleus and centrosome.

On impregnation follows shortly the process of division already briefly referred to, which is known as **segmentation** (Fig. 8). This either affects the entire substance (*holoblastic* or *complete* segmentation) or only a part (*meroblastic* or *incomplete* segmentation) of the oosperm. In the former case the ovum usually contains comparatively little or no food-yolk, consisting mainly of protoplasmic matter. The first stage in the process of segmentation is the mitotic division of the segmentation-nucleus, accompanied by the division into two parts of the substance of the protoplasm—the result being the formation of two cells, each with its nucleus (Fig. 8). Each of these two cells then divides—four cells being thus formed; the four divide to form eight; the eight divide to form sixteen, and so on; until, by the process of division and subdivision, the oosperm becomes segmented into a large number of comparatively small cells which are termed the *blastomeres*. This mass of cells is spherical in shape, and the rounded blastomeres of which it is composed project on its sur-

face so as to give it somewhat the appearance of the fruit of the mulberry, whence it is termed the *mulberry body* or *morula* stage. The blastomeres next become arranged regularly in a single layer—the embryo (Fig. 9, *A*) assuming the form of a hollow sphere, the *blastosphere* or *blastula*, with a wall composed of a

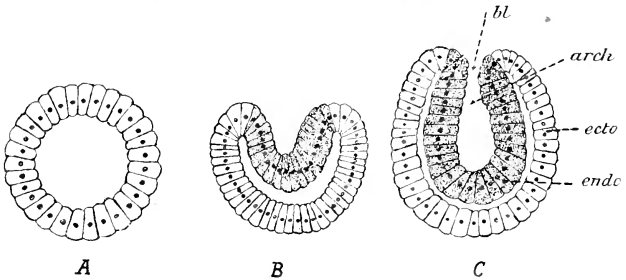

FIG. 9.—Gastrulation.

arch. archenteron ; *bl.* blastopore ; *ecto.* ectoderm ; *endo.* endoderm.

single layer of cells enclosing a cavity—the *segmentation cavity* or *blastocæle*.

One side of the hollow blastula next becomes pushed inwards or *invaginated* (Fig. 9, *B*, *C*), as one might push in one side of a hollow india-rubber ball, the result of this process of invagination, or *gastrulation* as it is termed, being the formation of a cup—the *gastrula* (Fig. 10)—with a double wall. The cavity of the cup-shaped gastrula is the *archenteron* or primitive digestive cavity; the opening is termed the *blastopore*; the outer layer of the wall of the cup is the *ectoderm* (or *epiblast*), the inner the *endoderm* (or *hypoblast*). The ectoderm and endoderm are the *primary germinal layers* of the embryo; from one or both of them are developed the cells of a third layer—the *mesoderm* (*mesoblast*)—which is subsequently formed between them.

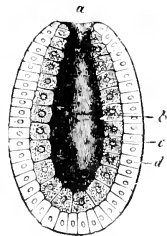

FIG. 10.—Gastrula in longitudinal section. *a.* blastopore ; *b.* archenteron ; *c.* endoderm ; *d.* ectoderm. (From Gegenbaur's *Comparative Anatomy*.)

This mode of formation of the primary germinal layers in holoblastic oosperms by a process of gastrulation prevails in a number of different sections of the animal kingdom.

In many animals, however, it becomes modified or disguised in various ways; and in certain cases it is doubtful if there occurs anything of the nature of true gastrulation.

The cells of the three germinal layers give rise to the various organs of the body of the fully-formed animal—each layer having

a special part to play in the history of the development. As the various parts of the embryo become gradually moulded from the cells of the germinal layers, it becomes evident, on comparison, that their internal structure—the form and arrangement of their constituent cells—is undergoing gradual modifications, the nature of which is different in the case of different parts. A *differentiation* of the cells is going on in the developing organs, resulting in the formation of a variety of different kinds of *tissues*.

4. TISSUES.

The cells of the tissues of the animal body differ greatly in form in different cases. Some are rounded, others cubical, others polygonal; some are shaped like a pyramid, others like a cone, others like a column or cylinder; others are flattened and tabular or scale-like. Some are Amœba-like or *amœboid*, resembling Amœba in their capacity for developing pseudopods. Cells situated on free surfaces are in many cases beset at their free ends with delicate, hair-like structures or *cilia* which vibrate to and fro incessantly during the life of the cell (Fig. 11, *a*); sometimes there is on each cell a single, relatively long, whip-like cilium, which is then termed a *flagellum* (*f*, *g*). Cells provided with cilia are termed *ciliated*, such as bear flagella *flagellate* cells.

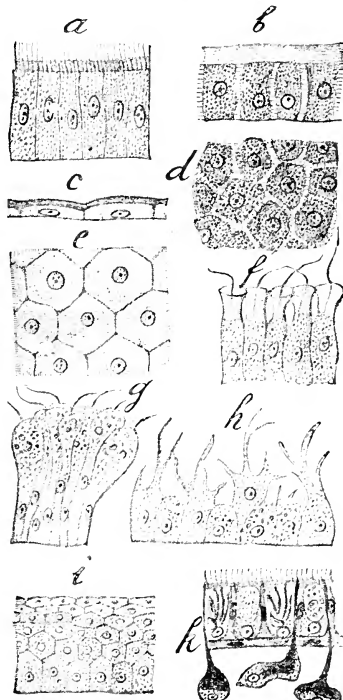

FIG. 11.—Various forms of epithelium. *a*, ciliated epithelium; *b*, columnar; *d*, surface view of the same; *c*, tessellated; *e*, the same from the surface; *f*, flagellate epithelium with collars; *g*, flagellate epithelium without collars; *h*, epithelium of intestine with pseudopods; *i*, stratified epithelium; *k*, deric epithelium of a marine planarian with pigment-cells, rod-cells, and sub-epithelial glands. (From Lang's *Comparative Anatomy*.)

Some tissues are composed entirely of cells. Usually the component cells of a tissue are distinct; but there are many examples

of tissues in which the cells have coalesced into an aggregation in which cell boundaries have disappeared and the nuclei alone indicate the originally separate elements: such a structure is termed a *syncytium*. Other tissues, again, though originating from cells or by the agency of cells, consist in greater or less measure of non-protoplasmic matter formed between the cells. Tissues composed entirely of cells take the form, for the most part, of membranes covering various surfaces, external and internal. Such membranes are known under the general name of **epithelia** (Fig. 11); they may consist of a single layer of cells (*a-h*) or may be many-layered (*i*); the former are termed *non-stratified*, the latter *stratified*,

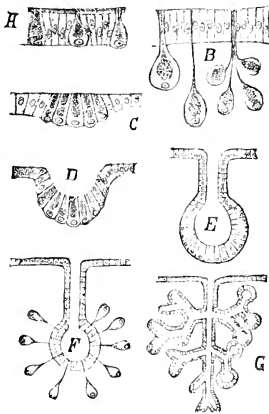

FIG. 12.—Diagram to illustrate the structure of glands. *A*, unicellular glands in an epithelium; *B*, unicellular glands lying below epithelium and communicating with the surface by narrow processes (ducts); *C*, group of gland-cells; *D*, group of gland-cells lining a depression; *E* and *F*, simple multicellular gland; *G*, branched multicellular gland. (From Lang.)

(Fig. 12, *A*). The *secretion* (or substance which it is the function of the gland to form and collect) gathers in such a case in the interior of the cell, and reaches the surface of the epithelium through a narrow prolongation of the cell which serves as the *duct* of the gland (*B*). In other cases the gland is *multicellular*—formed of a number of cells of the epithelium lining a depression or infolding, simple or complex in form, of the latter (*D-G*). In the central cavity of such a gland the secretion collects to reach the general surface or cavity lined by the epithelium through the passage or *duct*,

epithelia. The cells of an epithelium may be flattened (*c, e*), their edges being cemented together so as to form a continuous membrane; or they may be cubical or cylindrical or prismatic (*a, b*); in the case of a stratified epithelium the cells may be of different forms in different strata (*i*). The *epidermis*, which covers the outer surface of the body of an animal, is an example of an epithelium; sometimes it is stratified, sometimes unstratified; its cells sometimes possess cilia, sometimes are devoid of them. Lining the internal cavities of the body are layers of cells, or epithelia, sometimes in a single layer, sometimes in several layers, sometimes ciliated, sometimes non-ciliated.

Glands (Fig. 12) are formed for the most part by the modification of certain cells of epithelia. In many cases a single cell of the epithelium forms a gland, which is then termed a *unicellular gland*

A series of tissues in which the cells are, in most instances, subordinate, as regards bulk, to substances formed between them, is the group known as the **connective tissues**, including *gelatinous connective tissue*, *retiform connective tissue*, *fibrous connective tissue*, *cartilage*, and *bone*. In the majority of forms of connective tissue the cells lie embedded in an intermediate substance called the *matrix* or ground-substance of the connective tissue.

In the case of *gelatinous connective tissue* (Fig. 13) the ground-substance (*g*) is of a gelatinous character, sometimes supported by systems of fibres (*ef*), and the cells are usually stellate or starshaped with radiating processes. *Retiform* or *reticulate connective tissue* (Fig. 14) consists of stellate or branching cells with processes which are prolonged into fibres—the fibres from neighbouring cells joining so as to form a network. In this form of connective tissue there is no true ground-substance—the inter-spaces between the cells being filled with other tissue elements.

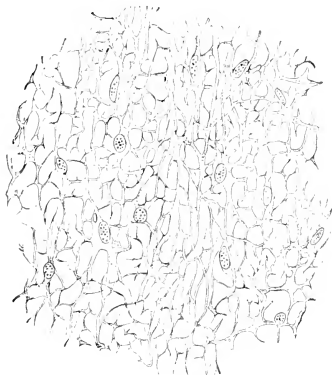

FIG. 14.—Reticular connective tissue. (From Lang.)

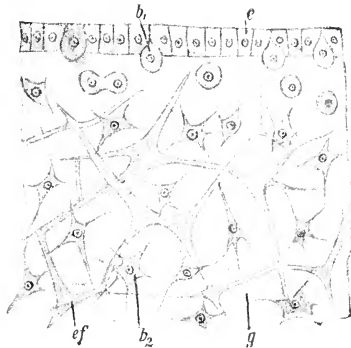

FIG. 13.—Gelatinous connective tissue of a Jellyfish. *b*₁, epithelial cell passing into the jelly; *b*₂, branched cells in the jelly; *e*, epithelium; *g*, gelatinous matrix; *ef*, elastic fibres. (From Lang's *Comparative Anatomy*.)

Fibrous connective tissue, which is a very common form, has a ground-substance containing gelatin, consisting mainly of numerous fibres, usually arranged in bundles. Thicker yellow elastic fibres may be present among the others, and may be so numerous as to give the entire tissue an elastic character. Associated with fibrous tissue, and produced by modification of its cells, is *adipose* or *fatty tissue* (Fig. 15), which consists

of masses of large cells in which the protoplasm has more or less completely become replaced by fat, the cells being bound together into groups and masses or *lobules* by means of fibrous connective tissue.

In the case of *cartilage* the matrix is of a firm but elastic character, sometimes quite homogeneous in appearance (*hyaline cartilage*, Fig. 16), sometimes

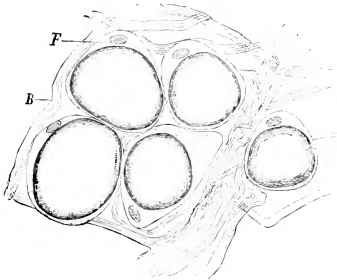

FIG. 15.—Fatty tissue. *F*, fat-cells; *B*, connective-tissue fibrils. (From Lang, after Ranvier.)

permeated by systems of fibres (*fibro-cartilage*, Fig. 17), which may be of an elastic nature (*yellow elastic cartilage*). The cells are usually rounded, and as a rule several occur together in spaces scattered through the matrix; sometimes condensation of the matrix round each of the spaces in which the cells are contained forms a cell-capsule.

The outer surface is covered over by a fibrous membrane—the *perichondrium*. Cartilage is frequently hardened by the deposition in the matrix of salts of lime, and is then known as *calcified cartilage*.

In *bone* or *osseous connective tissue* (Fig. 18) the matrix is exceedingly dense and hard owing to its being strongly impregnated with carbonate and phosphate of lime. It consists typically of numerous thin lamellæ, which are arranged partly parallel with the surface, partly concentrically around certain canals—the *Haversian*

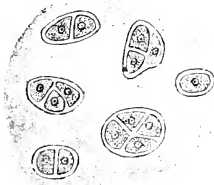

FIG. 16.—Hyaline cartilage.

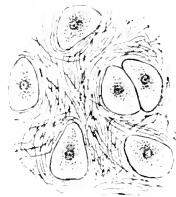

FIG. 17.—Fibro-cartilage.

canals (*c*)—which contain blood-vessels. The cells, or *bone-corpuscles*, lie in minute spaces—the *lacuna*—between the lamellæ, and a system of exceedingly fine channels—the *canaliculi*—extend from lacuna to lacuna, containing fine protoplasmic processes by means of which neighbouring cells are placed in communication with one another. The outer surface of the bone is covered by a vascular fibrous

membrane—the *periosteum*—which takes an active part in its growth and nutrition.

The connective tissues are all more or less passive in the functions which they perform, serving mainly for support and for binding together the various organs. **Muscular tissue**, on the

other hand, has an active part to play—this being the tissue by means of which, in general, all the *movements* of the body of an animal are brought about. Muscular tissue varies greatly in minute structure in different groups of animals, and even in different parts of the same animal.

It consists of microscopic fibres aggregated together into large bundles or layers. These fibres are composed of a substance—the *muscle-substance*—which when living has the special property of *contractility*, contracting or becoming shorter and thicker on the application of a *stimulus*. There

are two principal varieties of muscular tissue to be distinguished, termed respectively *non-striated* and *striated* muscle. Each fibre of non-striated muscle (Fig. 19) is usually a single, greatly elongated cell, sometimes branched, with a single nucleus;

it may contain a core of unaltered protoplasm, or all except the nucleus may be altered into muscle-substance; cross-striation is absent. A fibre of striated muscular tissue (Fig. 20) is formed by the close union of several cells which are represented by their nuclei (*n*). Sometimes there is a core of protoplasm; but

more usually the entire fibre is composed of muscle-substance, with perhaps a remnant of protoplasm in the neighbourhood of each nucleus. The substance of the fibre is crossed by numerous transverse bands and striæ, the precise significance of which is a matter of controversy. The fibre is usually enclosed in a delicate sheath—the *sarcolemma*. Striated muscular tissue

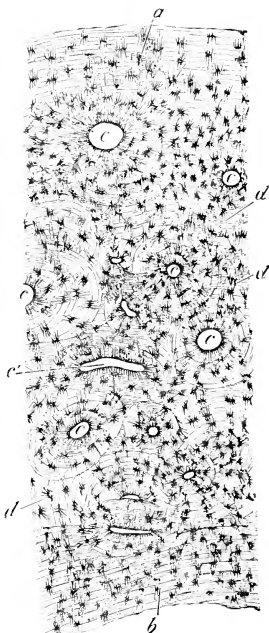

FIG. 18.—Transverse section of compact bone. *a*, lamellæ concentric with the outer surface; *b*, lamellæ concentric with the surface of the marrow cavity; *c*, sections of Haversian canals; *c'*, section of a Haversian canal just dividing into two; *d*, interstitial lamellæ. (From Huxley's *Lessons in Physiology*.)

is specially characteristic of parts in which rapid movement is necessary.

The principal elements of nervous tissue are *nerve-cells* and *nerve-fibres*.

Nerve-cells (Fig. 21) vary greatly in form; they are relatively



FIG. 19.—Non-striated muscle-cell. *f*, substance of fibre; *n*, nucleus; *p*, unaltered protoplasm in the neighbourhood of the nucleus. (From Huxley's *Lessons in Physiology*.)

large cells with large nuclei and one or several processes, one of which is always continuous with a nerve-fibre.

The *nerve-fibres* (Fig. 22), which are to be looked upon as greatly produced processes of nerve-cells, are arranged for the most part in strands which are termed *nerves*. The fibres themselves vary greatly in structure in different classes of animals. In the higher animals the most characteristic form of nerve-fibre is that which is termed the *medullated nerve-fibre*. In this there is a central cylinder—the *axis-cylinder* or *neuraxis* (*A*, *ax*)—which is the essential part of the fibre and is made up of numerous extremely fine *primitive fibrillæ*; this is surrounded by a layer of a white glistening material—the *white substance of Schwann* or *medullary sheath* (*med*), enclosed in turn in a very delicate membrane—the *neurolemma* (*neur*).

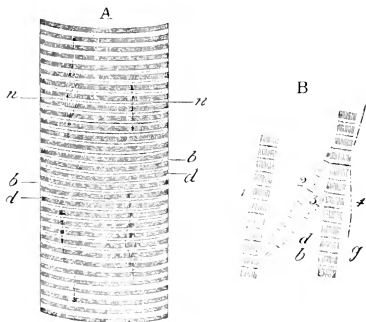

FIG. 20.—Striated muscle. *A*, part of a muscular fibre of a Frog; *B*, portion of striated muscle teased out to show separation into fibrillæ. (From Huxley's *Lessons in Physiology*.) *b*, *d*, *σ*, transverse bands and striæ; *n*, nuclei.

—the *corpuscles*—disseminated through a liquid *plasma*, which takes the place of the ground-substance of the connective tissues. In a large proportion of cases such corpuscles are similar to *Amœbæ* in their form and movements (*amaboid corpuscles*, *leucocytes*). In the blood of Vertebrates leucocytes occur along with coloured corpuscles of definite shape containing the red-colouring matter (*hæmoglobin*) of the blood. The leucocytes are able, like *Amœbæ*, to ingest solid particles, and under certain conditions a

number of them may unite together to form a single mass of protoplasm with many nuclei, termed a *plasmodium*.

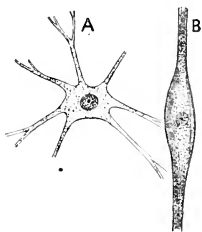

FIG. 21.—Nerve-cells. A, multipolar; B, bipolar.



FIG. 22.—Nerve-fibres. A, medullated; B, non-medullated. *ax*, neuraxis; *med*, medullary sheath; *neur*, neurolemma.

The characteristic cells of the **reproductive tissues** are the *ova* and the *spermatozoa* or *sperms*. The ova (Fig. 6), when fully formed, are relatively large, usually spherical cells, sometimes composed entirely of protoplasm, but usually with an addition of nutrient *food-yolk*. Each ovum, as already mentioned, encloses a large nucleus (*germinal vesicle*) and in the interior of that one or more nucleoli or *germinal spots*. The sperms (Fig. 23) are extremely minute bodies, nearly always motile, usually slender and whip-like, tapering towards one extremity, and commonly with a rounded *head* at the other. The sperms are developed by a succession of cell-divisions from certain cells—the *primitive male cells*—similar in character to immature ova. During the course of this development (*spermatogenesis*) there is, as in the maturation of the ovum (p. 20), a reduction of the number of chromosomes in each nucleus by one half.

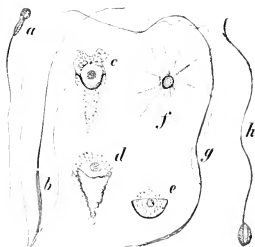

FIG. 23.—Various forms of spermatozoa. *a*, of a Mammal; *b*, of a Turbellarian worm; *c*, *d*, and *e*, of Nematode worms; *f*, of a Crustacean; *g*, of a Salamander; *h*, the commonest form with oval head and long flagellum. (From Lang's *Comparative Anatomy*.)

5. ORGANS.

The chief systems of organs of an animal are the *integumentary*, the *skeletal*, the *muscular*, the *alimentary* or *digestive*, the

vascular, the *respiratory*, the *nervous*, the *excretory*, and the *reproductive*.

The **skin** or **integument** consists in the majority of animals of a cellular membrane—the *epidermis*—to which reference has already been made, with, superficial to it, in many animals, a non-cellular layer, the *cuticle*, and below it usually a fibrous layer which is known as the *dermis*. The epidermis may consist of a single layer or may be stratified; it is frequently ciliated, and some of its cells frequently assume the form of unicellular glands. Modification of its superficial layers of cells gives rise frequently to the formation of hard structures contributing to the development of an *exoskeleton* (*vide infra*).

The *cuticle*, when present, varies greatly in thickness and consistency. Sometimes it is very thin and delicate; in many animals it becomes greatly thickened and hardened so as to form a strong protecting crust, sometimes of a material termed *chitin*, somewhat akin to horn in consistency, sometimes solidified by the deposition of calcareous salts. The cuticle is to be looked upon as a secretion from the cells of the epidermis; but the term is frequently applied in the case of the higher animals—in which a cuticle in the strict sense of the term is absent—either to a superficial part of the epidermis, in which the cells have become altered and horny, or to the whole of that layer.

The layer or layers of the integument situated beneath the epiderm consist of fibrous connective tissue and muscular fibres, constituting, as mentioned above, the *derm* or *dermis*.

The term **skeleton** or **skeletal system** is applied to a system of hard parts, external or internal, which serves for the protection and support of softer organs and often for the attachment of muscles. This system of hard parts may be external, enclosing the soft parts, or it may lie deep within the latter, covered by integument and muscles: in the former case it is termed an *exoskeleton* or *external skeleton*; in the latter an *endoskeleton* or *internal skeleton*. In many groups of animals both systems are developed. An *exoskeleton* is formed by the thickening and hardening of a part or the whole of one of the layers of the integument enumerated above; or more than one of these layers may take part in its formation. In many invertebrate animals, such as Insects, Crustaceans, and Molluscs, it is a greatly thickened and hardened cuticle which forms the exoskeleton. The horny scales of Reptiles, the feathers of Birds, and the fur of Mammals are examples of an exoskeleton derived from the epidermis, while the bony shell of Turtles and the bony scales of Fishes are examples of a dermal exoskeleton.

When an *endoskeleton* is present, it usually consists either of cartilage or bone or of both; but sometimes it is composed of numerous minute bodies (*spicules*) of carbonate of lime or of a siliceous material.

A skeleton, whether internal or external, is usually composed of a number of pieces which are movably articulated together, and which thus constitute a system of jointed levers on which the muscles act.

The **alimentary or digestive system** consists of a cavity or system of cavities into which the food is received, in which it is digested, and through the wall of which the nutrient matters are absorbed; together with certain glands.

In the lowest groups in which a distinct *alimentary* or *enteric cavity* is present it is not distinct from the general cavity of the body; but in all higher forms there is an *enteric canal* which is suspended within the cavity of the body, and the lumen of which is completely shut off from the latter. It may have simply the form of a sac or bag with a single opening which serves both as *mouth* and *anus*; in other cases the sac becomes branched and may take the form of a system of branching canals. In most animals, however, the alimentary canal has the form of a longer or shorter tube beginning at the mouth and ending at the anal opening (Fig. 24). In most cases there are organs in the neighbourhood of the mouth serving for the seizure of food; these may be simply *tentacles* or soft finger-like appendages, or they may have the form of *jaws*, by means of which the food is not only seized, but torn to pieces or pounded up to small fragments in the process of mastication. The alimentary canal itself is usually divided into a number of regions which differ both in structure and in function.

In general there may be said to be three regions in the alimentary canal—the *ingestive*, the *digestive* and *absorbent*, and the *egestive* or *efferent*. The *ingestive* region is the part following behind the mouth, by which the food reaches the digestive and absorbent region. But, besides serving as a passage, it may also act as a region in which the food undergoes certain processes, chiefly mechanical, which prepare it for digestion. This ingestive region may comprise a *mouth-cavity* or *buccal cavity*, a *pharynx*, an *oesophagus* or *gullet*, with sometimes a muscular *gizzard* which may be provided with a system of teeth for the further breaking up of the food, and sometimes a *crop* or food-pouch.

The *digestive* and *absorbent* region is the part in which the chemical processes of digestion go on, and from which takes place the absorption of the digested food-substances. Into this part are poured the secretions of the various *digestive glands*, which act on the different ingredients of the food so as to render them more soluble. Through the lining membrane of this part the digested nutrient matter passes, to enter the blood-system. This region may present a number of subdivisions; nearly always there are at least two—a wide sac, the *stomach*, and a narrow tube, the *intestine*.

The *egestive* or *efferent* region of the alimentary canal is the

posterior part of the intestine, in which digestion and absorption do not go on, or only go on to a limited extent, and which serves mainly for the passage to the anal opening of the *faeces* or unabsorbed effete matters of the food.

The whole of the interior of the alimentary canal is lined by a layer of cells—the *alimentary* or *enteric epithelium*. The form and arrangement of the cells of this epithelium vary greatly in different groups of animals. Usually, they are vertically elongated, prismatic or columnar, or pyramidal in shape; frequently they are ciliated. In some lower forms, the cells lining the alimentary cavity have the power, like *Amœba*, of thrusting

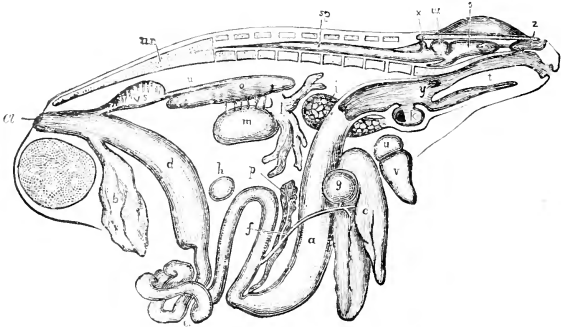

FIG. 24.—General view of the viscera of a male **Frog**, from the right side. *a*, stomach; *b*, urinary bladder; *c*, small intestine; *d*, cloacal aperture; *d*, large intestine; *e*, liver; *f*, bile-duct; *g*, gall-bladder; *h*, spleen; *i*, lung; *k*, larynx; *l*, fat-body; *m*, testis; *n*, ureter; *o*, kidney; *p*, pancreas; *s*, cerebral hemisphere; *sp*, spinal cord; *t*, tongue; *u*, auricle; *ur*, urostyle; *v*, ventricle; *vs*, vesicula seminalis; *w*, optic lobe; *x*, cerebellum; *y*, Eustachian recess; *z*, nasal sac. (From Marshall.)

forth processes of their protoplasm (Fig. 11, *h*), and of taking minute particles of food into their interior to become digested and absorbed (*intracellular digestion*). Sometimes they are all more or less active in secreting a fluid destined to act on the food and render it more soluble; sometimes this function is confined to certain of the cells, which have a special form; very often the secreting cells line special little pouch-like, simple or branched *glands*, opening by a passage or *duct* into the main cavity of the alimentary canal. Besides these glands formed from specially modified cells of the enteric epithelium there are nearly always present certain large special glands, separate from the alimentary canal itself, but opening into it by means of ducts. Of these the most generally-occurring are the glands termed *salivary glands*, *liver*, and *pancreas*. The *salivary glands* have the function of secreting a fluid called the *saliva*, which, in many cases at least, has a special action on starchy matters, converting them into sugar. The ducts of these

glands open always, not into the digestive, but into some part of the ingestive region of the alimentary system.

The most important function of the *liver*—properly so called—is one distinct from the process of digestion; its secretion—the *bile*—has, however, at least a mechanical effect on this process, and assists the secretion of the pancreas in its effects upon fat. In lower forms the organ to which the term liver is commonly applied appears in many cases to combine the functions of a true liver with that of a pancreas, and is thus more appropriately termed *hepato-pancreas* or *liver-pancreas*.

The *pancreas* secretes a fluid—the *pancreatic juice*—which has a very important effect in digestion. It renders substances of the nature of albumins soluble by converting them into modifications termed *peptones*; it converts starch into the soluble substance sugar; it acts on fatty matters in such a way as to convert them into *emulsions* which are capable of being taken up and absorbed, and it effects the splitting up of part of the fat into fatty acids and glycerine.

When the food has been acted on by the various digestive secretions, the soluble part of it is fitted to be taken up and absorbed through the wall of the alimentary canal into the blood (in animals in which a blood-system exists), or into the fluid which takes its place. In the higher animals a part of the soluble matter of the food passes directly into the blood contained in the blood-vessels; while another part is taken up by a set of special vessels, the *lacteals*, which are a part of the lymphatic system, and reaches the blood indirectly.

In some of the lower groups of animals there is no system of **blood-vessels**, and the nutrient matter of the food, absorbed through the alimentary canal, merely passes from cell to cell throughout the body, or is received into a space or series of spaces containing fluid intervening between the alimentary canal and the wall of the body. But in the majority of animals there is a system of branching tubes containing a special fluid—the *blood*, and it is into this that the nutrient matter absorbed from the food sooner or later finds its way. The blood has for one of its principal functions the conveyance of the nutrient matters from the alimentary canal throughout the body, so that the various organs may select from it the material which they require for the carrying on of their functions. To carry out this office the blood is contained in a complicated system of branching tubes or *blood-vessels*.

The essence of the process of **respiration**, as we have already seen, is an interchange of oxygen and carbonic acid which takes place between the tissues of an organism and the surrounding medium, whether air or water. During the vital changes which go on in the bodies of all animals, as in *Amœba*, oxygen is constantly being used up and carbonic acid being formed. The necessary

supply of oxygen has to be got from the air, or, in the case of aquatic animals, from the air dissolved in the surrounding water. At the same time the carbonic acid has to be got rid of. In the lowest animals—as for instance *Amœba*, and many of higher organisation—the oxygen passes inwards and the carbonic acid outwards through the general surface of the body. But in the great majority of animals there is a special set of organs—the organs of respiration—having this particular function. In some animals these organs of respiration are processes, simple or branched, lined by a very delicate membrane, and richly supplied with blood-vessels. Such processes are called *gills* or *branchiæ*; they are specially adapted for the absorption of oxygen dissolved in water.

In other animals the oxygen is obtained directly from the air; and in such air-breathing forms the organ of respiration is very often a sac, either simple or compound, termed a *lung*. The interior of this sac is lined with an epithelium of extreme delicacy, immediately outside of which is a network of microscopic blood-vessels or *capillaries* with thin walls; and the oxygen readily passes from the air in the cavity of the lung through its lining and the thin wall of the blood-vessel into the blood. In other air-breathing forms the organs of respiration are *tracheæ*, which are ramifying tubes, by means of which the air is conveyed to all parts of the body. In such forms, of which the Insects are examples, the air is conveyed, by means of these tubes, from openings on the surface of the body to all parts, and respiration goes on in all the organs.

In order that the air or water in contact with the surface of the lungs or gills may be renewed, there are usually special mechanical arrangements. In many gill-bearing animals the gills are attached to the legs, and are thus moved about when the animal moves its limbs. In others certain of the limbs are constantly moving in such a way as to cause a current of water to flow over the gills. In air-breathing forms there is usually a pumping apparatus, by means of which the air is alternately drawn into and expelled from the lungs.

In a great number of animals there is in the blood a substance called *hemoglobin*, which has a strong affinity for oxygen; and the oxygen from the air, when it enters the blood, enters into a state of loose chemical combination with it. In this state, or simply dissolved in the fluid plasma of the blood, the oxygen is conveyed throughout the body.

Thus the blood, besides receiving the solid and liquid food from the alimentary canal and carrying it throughout the body for distribution, receives also the *oxygen* or *gaseous food*, and supplies it to the parts requiring it. In all parts of the body in which vital action is taking place chemical changes are constantly going

on. These chemical changes in the tissues, having for their result the production of heat, motion, secretion, and nerve-action, are for the most part of the nature of *oxidations*, and involve a constant consumption of oxygen; while a product which becomes formed as a result of this action is *carbonic acid gas*.

To carry out all the functions which it has to perform as a distributor of nourishment and oxygen and a remover of carbonic acid, the blood has to be moved about through the vessels—to *circulate* throughout the various organs. In the lowest forms in which a definite blood-system is to be recognised, this movement is effected in great measure by the general movements of the body of the animal. In others certain of the vessels contract and drive the blood through the system; such contractions are of a *peristaltic* character, the contractions being of the nature of constrictions running in a definite direction along the course of the vessel, with an effect similar to that produced by drawing the hand along a compressible india-rubber tube.

In all higher forms the movement of the blood is effected by means of a special organ—the *heart*. The heart is a muscular organ which by its contractions forces the blood through the system of vessels. In its simplest form it usually consists of two chambers, both with muscular walls,—the one, called the *auricle*, receiving the blood and driving it into the other, which is called the *ventricle*. The latter, in turn, when it contracts, drives the blood through the vessels to the various parts of the body—the return of the blood backwards to the auricle from the ventricle being prevented by the presence of certain *valves*, which act like folding doors opening from the auricle towards the ventricle, but closing when pressure is exerted in the opposite direction. In the higher animals the heart becomes a more complex organ than this, with a larger number of chambers and a more elaborate system of valves.

Carbonic acid, as already mentioned, is a waste-product constantly being produced in the tissues and being carried off by the blood to pass out by the gills or lungs. Besides the carbonic acid, there are constantly being formed waste-substances of another class—viz., substances containing nitrogen, of which *uric acid* and *urea* are the principal ultimate forms. These are separated from the blood and thrown out of the body by a distinct set of organs called **renal organs**, or **organs of urinary excretion**. The form of these organs varies greatly in the different groups; in many cases they are more or less intimately connected with the genital system.

In place of the simple contractions and extensions of the protoplasm which constitute the only movements of *Amœba*, the higher animals are capable of complex and definite movements. These are brought about by the agency of a set of organs termed the **muscles**. A muscle is a band or sheet of muscular fibres

endowed in the living state with the property of *contractility*, by virtue of which, when stimulated in certain ways, it contracts in the direction of its length, becoming shortened, and, at the same time, thickened (Fig. 25). The extremities of the muscle are frequently composed, not of contractile muscular fibres, but of a form of strong fibrous connective tissue—the *tendon* of the muscle. The ends of the muscle are usually firmly attached to two different parts of the jointed framework or skeleton, external or internal; and, when the muscle contracts and becomes shortened, these two parts are drawn nearer to one another.

In all but the most lowly-organised animals there is a system of organs—the **nervous system**—by means of which a communication is effected between the various parts of the body, enabling them to work in harmony, and by means of which also a communication is established

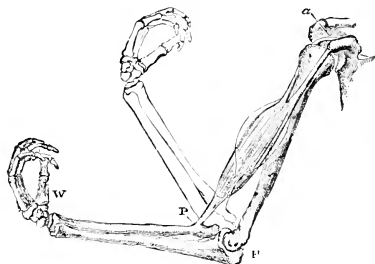

Fig. 25.—Bones of the human arm and fore-arm with the biceps muscle, showing the shortening and thickening of the muscle during contraction and the consequent change in the relative position of the bones—viz., flexion of the fore-arm on the upper arm. (From Huxley's *Physiology*.)

between the organism and the external world. The two essential elements of the nervous system—the nerve-cells and nerve-fibres—have a regular arrangement which varies in the different animal types both as regards structural details and the relations borne to the other systems of organs; but there are to be recognised two

chief parts or sets of parts—the *central* and the *peripheral*.

The *central parts* of the nervous system consist (Fig. 26) of certain aggregations of nerve-matter known as *nerve-ganglia*, containing a large number of nerve-cells; a relatively large mass of this matter may be collected together to form a *brain*. To or from these central parts pass all the systems of nerve-fibres, constituting the *peripheral* part of the system; the central parts have the office both of receiving impressions conveyed by the nerve-fibres from the surface, from the organs of special sense, and from the internal organs, and of sending off messages through similar channels to the various parts of the body—to muscles, to glands, to alimentary canal, and to vascular system. When a movement is to be effected a message passes from the nerve-centre along a nerve-fibre to a muscle and causes it to contract; when an organ requires the amount of blood supplied to it to be increased or diminished a message is conveyed along a nerve-fibre and causes the dilatation

or contraction of the blood-vessels of the part; and a similar initiatory or controlling influence is exerted over the activities of all the organs.

In certain groups of animals all the impressions from the external world are received through the integument of the general surface, and this is the case in all animals with the general impressions of touch and of heat and cold. The sensitiveness of the integument to such general impressions may be increased by the presence in it of a variety of tactile papillæ or corpuscles having nerve-fibres terminating in them. In most animals, however, there are certain organs, the **organs of special sense**, adapted to receiving impressions of special kinds—*eyes* for the reception of the impressions produced by light, *ears* for the reception of those produced by the waves of sound, *olfactory organs* or organs of smell, and *gustatory organs* or organs of taste. The most rudimentary form of eye is little more than a dot of pigment which absorbs some of the rays of bright light—these producing a nerve-disturbance in certain neighbouring nerve-cells. To this may be added clear, highly-refracting bodies which intensify the effect. In the higher types of eye there are the same characteristic

parts—the clear, highly-refracting substance, the pigment, and the nerve-cells; but each has undergone a development resulting in the construction of an organ adapted to the reception of light-

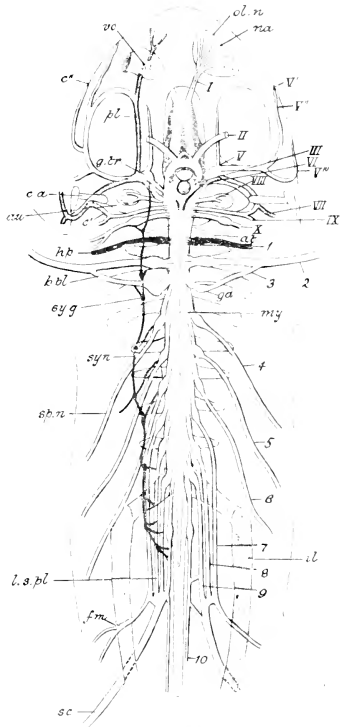

FIG. 26.—Nervous system of the **Frog**. (From Howes's *Atlas*.)

impressions of a very definite character. The highly-refracting body assumes the form of a *lens* for the focussing of the light-rays; the nerve-cells are arranged within a regular layer, the *retina*, from which nerve-fibres pass to the central part of the nervous system; the pigment is so arranged as to absorb the light-rays and prevent their passage beyond the retina, and in certain cases also lines a diaphragm, the *iris*, with a central aperture through which the rays of light are admitted to the central parts of the eye. In some animals (Insects, Crustacea) the eye consists of a very large number of independent elements, each with its refracting apparatus, its nervous element, and its absorbing pigment.

The *ear* in its simplest form is a membranous sac or *otocyst* with internally projecting stiff cilia, and containing a liquid in which there lie a number of particles of carbonate of lime. The sound-waves evidently set in vibration the liquid and its contained calcareous particles, and by means of these vibrations acting on the cilia, an impression of a definite character is produced in the cells of a neighbouring nerve-ganglion. In higher forms the apparatus for receiving the vibrations becomes extremely complex, and there is elaborated a nervous mechanism by which sounds of different pitch and intensity produce impressions of a distinct character. The organ of hearing usually possesses the additional function of an organ ministering to the sense of *rotation*, and thus has an important part to play in the maintenance of the equilibrium of the body.

The essential elements of the **reproductive organs**—the *ova* and *spermatozoa*—have already been briefly alluded to (p. 31). The ova are developed in an organ termed the *ovary*, and the sperms in an organ called the *spermary* or *testis*. Sometimes ovaries and testes are developed in the same individual, when the arrangement is termed *monocious* or *hermaphrodite*; sometimes the ovaries occur in one set of individuals—the females—and the testes in another set—the males, when the term *unisexual* or *diocious* is employed. Very frequently the male differs from the female in other respects besides the nature of the reproductive elements—in size, colour, and the like; when such differences are strongly marked the animal is said to be *sexually dimorphic*. The ova and sperms are usually conveyed to the exterior by canals or ducts—the ovarian ducts or *oviducts*, and the *testicular ducts*, *spermiducts*, or *vasa deferentia*. In some instances the ova are impregnated after being discharged from the oviducts, and the development of the young takes place externally; in other cases the impregnation takes place in the oviduct, and the young become fully developed in the interior of a special enlargement of the oviduct termed the *uterus*. In the former case the animal is said to be *oviparous*, in the latter *viviparous*; but there are numerous intermediate gradations between these two extremes.

6. THE REPRODUCTION OF ANIMALS.

In a limited number of groups of animals reproduction takes place by means of cells corresponding to ova developed in organs similar to ovaries, but without impregnation by means of sperms. This phenomenon is known as **parthenogenesis** (*cf.* p. 21).

Besides the sexual process of reproduction by means of ova and spermatozoa, there are in many classes of animals various **asexual** modes of multiplication. One of these—the process of *simple binary fission*—has been already noticed in connection with the reproduction of *Amœba*. The formation of *spores* by *multiple fission* is an asexual mode of multiplication which occurs only in the Protozoa, and will be described in the account of that group. Multiplication by *budding* takes place in a number of different classes of animals. In this form of reproduction a process or *bud* (Fig. 27, *bd*) is given off from some part of the parent animal; this bud sooner or later assumes the form of the complete animal, and may become detached from the parent either before or after its development has been completed, or may remain in permanent vital connection with the parent form.

When the buds, after becoming fully developed, remain in vital continuity with the parent, a sort of compound animal, consisting of a greater or smaller number of connected units, is the result.

Such a compound organism is termed a *colony*, and the component units are termed *zooids*. In some cases such a colony is produced by a process which is more correctly termed *incomplete fission* than budding.

Alternation of Generations ; Heterogamy ; Pædogensis.—

In the life-history of a considerable number of animals, a stage in which reproduction takes place by a process of budding or fission alternates with a stage in which there occurs a true sexual mode of reproduction. Such a phenomenon is termed *alternation of generations* or *metagenesis*. The term *heterogamy* is applied to cases in which two different sexual generations—usually a true sexual and a parthenogenetic—alternate with one another.

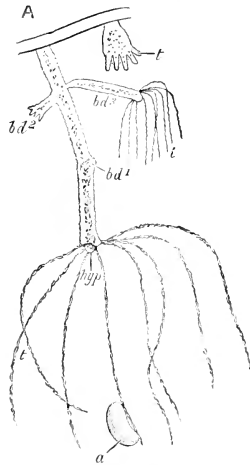

FIG. 27.—Fresh-water polype (**Hydra**); two specimens, the one expanded, the other contracted, showing multiplication by budding. *bd*,¹ *bd*,² *bd*,³ buds in various stages of growth. (From Parker's *Biology*.)

Pædogensis, or the development of young by a sexual process from individuals that have not attained the adult condition, is a phenomenon which is to be observed in some groups of animals.

7. SYMMETRY.

The general disposition or **symmetry** of the parts in an animal presents two main modifications—the *radial* and the *bilateral*. The *gastrula* (p. 24) is the simplest and most generalised form among multicellular animals or Metazoa; but no adult animal retains

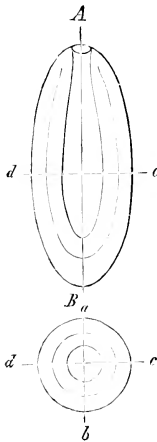

FIG. 28.—Diagram of the axes of the body *AB*, primary axis; *ab, cd*, secondary axes. The lower figure is a transverse section of the upper one, showing its two secondary axes. (From Gegenbaur.)

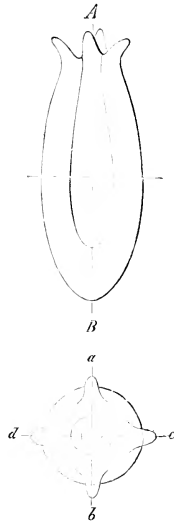

FIG. 29.—Radial symmetry. Letters as in Fig. 28. The processes at *A* are the tentacles; the lower figure represents the upper or oral surface. (From Gegenbaur.)

this simple shape. In the *gastrula* we may imagine a central *primary axis* (Fig. 28, *AB*) passing through the middle of the blastopore and of the archenteric cavity, and a series of *secondary axes* (*ab, cd*) running at right angles to this to the outer surface. In a symmetrical *gastrula* the secondary axes would be all equal. Many animals are in the adult condition similar in their symmetry to the *gastrula*, except that there are special developments along a series of regularly arranged radiating secondary axes; these radial developments may be in the form of tentacles or radially arranged processes (Fig. 29), or may assume the character of a radial arrange-

ment of internal parts. Such an animal is said to be *radially symmetrical*. The body of a radially symmetrical animal is capable of being divided into a series of equal radial parts or *antimeres*, each of which is symmetrically disposed with regard to one of the secondary or radial axes.

In animals which are not permanently fixed, locomotion usually takes place in the direction of the primary axis of the body, and one side, habitually directed downwards, becomes modified differently from the other, which is habitually directed upwards: a *lower* or *ventral* surface becomes distinguishable from an *upper* or *dorsal*. Thus the radial symmetry is now disturbed; the secondary axes have become unequal; the *dorso-ventral* or *vertical* secondary axes are, to a greater or less extent, different from the *transverse* or *horizontal* secondary axes, and the body of an animal having such a disposition of the parts is divisible into two equal lateral halves or *hemisomes* by a median vertical plane passing through the primary axis. This is the *bilateral symmetry* observable in all but a few types of animals.

Sometimes the bilaterally symmetrical animal is unsegmented; sometimes it is divided into a series of *segments* or *metameres*. A distinct *head* may be present or absent. The head end or anterior end is that which, save in exceptional cases, is directed forwards in locomotion. It is towards this end that the organs of special sense are situated, as well as the opening of the mouth and the organs for the prehension and mastication of food. A head is developed when the anterior part bearing these structures is marked off externally from the rest. In segmented animals the head consists of a number of segments amalgamated together, and it contains the brain or the principal central ganglia of the nervous system.

8. THE PRIMARY SUBDIVISIONS OR PHYLA OF THE ANIMAL KINGDOM.

The various systems of organs—digestive, circulatory, nervous, excretory, etc.—present under one form or another in all the higher groups of animals, are variously arranged and occupy various relative positions in different cases, producing a number of widely different plans of animal structure. According as their structure conforms to one or another of these great plans, animals are referred to one or another of the corresponding great divisions or *phyla* of the animal kingdom. That animals do present widely differing plans of structure is a matter of common knowledge. We have only to compare the true Fish, such as Cod, Haddock, etc., in a fishmonger's shop with the Lobsters and the Oysters, to recognise the general nature of such a distinction. The first-named are characterised by the possession of a backbone and skull, with a brain and

spinal cord, and of two pairs of limbs (the paired fins); they belong to the great vertebrate or backboneed group—the division *Vertebrata* of the phylum *Chordata*. The Lobsters, on the other hand, in which these special vertebrate structures are absent, possess a body which is enclosed in a hard jointed case, and a number of pairs of limbs also enclosed in hard jointed cases and adapted to different purposes in different parts of the body—some being feelers, others jaws, others legs: their general type of structure is that which characterises the phylum *Arthropoda*. The Oysters, again, with their hard calcareous shell secreted by a pair of special folds of the skin constituting what is termed the mantle, and with a special arrangement of the nervous system and other organs which need not be described here, are referable to the phylum *Mollusca*. Other familiar animals are readily to be recognised as belonging to one or other of these great phyla. A Prawn, a Crab, a Blue-bottle Fly, a Spider, are all on the same general plan as the Lobster: they are jointed animals with jointed limbs, and have the internal organs occupying similar positions with relation to one another: they are all members of the phylum *Arthropoda*. Again, a Mussel, a Snail, and a Squid are all to be set side by side with the Oyster as conforming to the same general type of structure: they are all members of the phylum *Mollusca*. A Dog, a Lizard, and a Fowl, again, are obviously nearer the Fish: they all have a skull and backbone, brain and spinal cord, and two pairs of limbs, and are members of the great group *Chordata*.

Altogether twelve phyla are to be recognised, viz. :—

- | | |
|----------------------------|----------------------------|
| I. <i>Protozoa</i> | VII. <i>Molluscoida</i> |
| II. <i>Porifera</i> | VIII. <i>Echinodermata</i> |
| III. <i>Cœlenterata</i> | IX. <i>Annulata</i> |
| IV. <i>Platyhelminthes</i> | X. <i>Arthropoda</i> |
| V. <i>Nemathelminthes</i> | XI. <i>Mollusca</i> |
| VI. <i>Trochelminthes</i> | XII. <i>Chordata</i> |

But these do not comprise all known animals. There are a number of smaller groups which are only very doubtfully to be associated with one or other of the phyla; and it is in some cases chiefly to avoid multiplication of the latter that such groups are not treated as independent. Such forms, until their places are more definitely fixed, are best dealt with as appendices to the phyla to which they appear most nearly related.

SECTION II

PHYLUM PROTOZOA

IN the preceding section we learnt the essential structure of an animal cell, and it was pointed out that in the lowest organisms the entire individual consists of a single cell. All such *unicellular* animals are placed in the lowest primary subdivision of the animal kingdom—the phylum Protozoa.

We have also learnt that cells vary considerably in character. They may be *amoeboid* or capable of protruding temporary processes of protoplasm called pseudopods; *flagellate*, or produced into one or more—always a small number—of threads having an intermittent lashing movement; *ciliated*, or produced into numerous rhythmically moving threads of protoplasm; or *encysted*, the protoplasm being enclosed in a cell-wall. Moreover, under certain circumstances, amoeboid cells may fuse with one another to form a *plasmodium*.

These well-marked phases in the life of the cell allow us to divide the Protozoa into subdivisions called *Classes*. The same organism may be amoeboid, flagellate, encysted, and plasmodial at various stages of its existence, but nevertheless we find certain forms in which the dominant phase in the life-history is amoeboid, others which are characteristically flagellate or ciliated, others again in which the tendency to form plasmodia is a distinctive feature. In this way five well-marked groups of unicellular organisms may be distinguished.

Class 1. RHIZOPODA.—Protozoa in which the amoeboid form is predominant, the animal always forming pseudopods. Flagella are often present in the young, and occasionally in the adult. Encystation frequently occurs.

Class 2. MYCETOZOA.—Terrestrial Protozoa in which the plasmodial phase is specially characteristic, as also is the formation of large and often complex cysts.

Class 3. MASTIGOPHORA.—Protozoa in which the flagellate form

is predominant, although the amoeboid and encysted conditions frequently occur.

Class 4. SPOROZOA.—Parasitic Protozoa without special locomotive parts in the adult. Encystation is almost universal, and the young may be flagellate or amoeboid.

Class 5. INFUSORIA.—Protozoa which are always ciliated, either throughout life or in the young condition.

CLASS I.—RHIZOPODA.

I. EXAMPLE OF THE CLASS—*Amœba proteus*.

Amœba has been fully described in the preceding section; it will therefore be unnecessary to do more than recapitulate the most essential features in its organisation.

Amœba is an irregular mass of protoplasm (Fig. 30, *E*) about $\frac{1}{6}$ mm. in diameter, produced into irregular processes or *pseudopods* (*psd*) of variable size and form and capable of being protruded and retracted, often with considerable rapidity. The protoplasm is divisible into a granular internal substance, the *endosarc* or *endoplasm*, and a clear outer layer, the *ectosarc* or *exoplasm*; the difference between the two is hardly a structural one, but depends simply on the accumulation of granules in the central portion. The granules are, for the most part, various products of metabolism—proteinaceous or fatty.

Imbedded in the endosarc is a large *nucleus* (*nu*), of spherical form, consisting of a clear achromatic substance, enclosed in a membrane, and containing minute granules of chromatin. The *contractile vacuole* (*c. vac.*), a very characteristic structure of the Protozoa, lies in the outer layer of the endosarc, and exhibits rhythmical movements, contracting and expanding at more or less regular intervals.

Amœba feeds by ingesting minute organisms (Fig. 30, *C, f. vac.*) or fragments of organisms—*i.e.*, by enveloping them in its substance, retaining them until the proteids they contain are dissolved and assimilated, and then crawling away and leaving the undigested remnants behind.

Amœbæ are sometimes found to undergo *encystation*; the pseudopods are withdrawn and the protoplasm surrounds itself with a cell-wall or *cyst* (*D, cy*), from which, after a period of rest, it emerges and resumes active life. The cyst is formed of a *chitinoid* material—*i.e.*, a nitrogenous substance allied in composition to horn and to the chitin of which the armour of Insects, Crayfishes, etc., is composed.

Reproduction takes place in *Amœba proteus* by *simple* or *binary fission*; direct or amitotic division of the nucleus is followed by division into two of the cell-body (I). Occasionally two Amœbæ

have been observed to *copulate* or undergo complete fusion, but nothing is known of the result of this process or of its precise significance in this particular case.

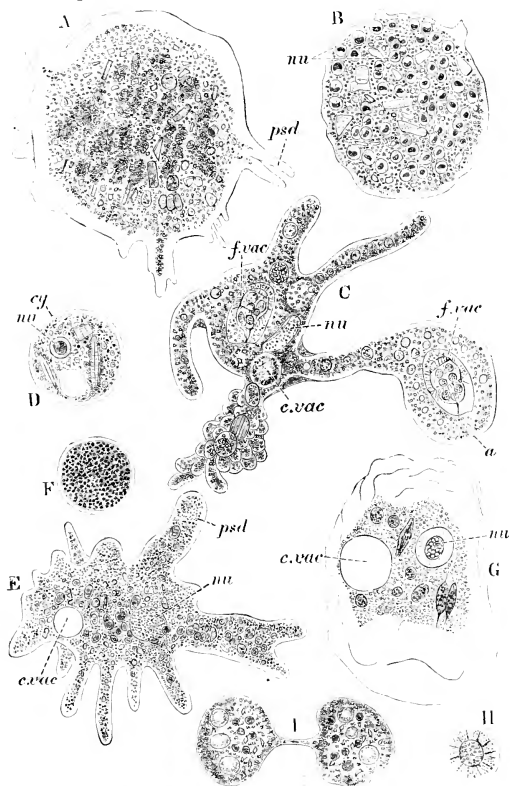

FIG. 30.—**Amoeba**, *A*, *A. quarta*; *B*, the same killed and stained; *C*, *A. proteus*; *D*, encysted specimen; *E*, *A. proteus*; *F*, nucleus of same, stained; *G*, *A. verrucosa*; *H*, nucleus of same, stained; *I*, *A. proteus*, undergoing binary fission; *a*, point of union of enclosing pseudopods; *c. vac.* contractile vacuole; *cy*, cyst; *f. vac.* food-vacuole; *nu*, nucleus (numerous in *A. quarta*); *psd.* pseudopod. (From Parker's *Biology*, after Leidy, Gruber, and Howes.)

2. CLASSIFICATION AND GENERAL ORGANISATION.

The Rhizopoda differ among themselves in the character of their pseudopods, which may be short and blunt or long and

delicate ; in the number of nuclei ; and in the presence or absence of a hard shell within or around the protoplasm. The following five orders may be distinguished :—

ORDER 1.—LOBOSA.

Rhizopoda with short, blunt pseudopods. There is a clear distinction between exoplasm and endoplasm.

ORDER 2.—FILOSA.

Rhizopoda with fine branched pseudopods which do not fuse except near the bases : no exoplasm.

ORDER 3.—FORAMINIFERA.

Shelled Rhizopoda with fine, branched, and anastomosing pseudopods.

ORDER 4.—HELIOZOA.

Rhizopoda with fine, stiff, radiating pseudopods.

ORDER 5.—RADIOLARIA.

Rhizopoda having a shell in the form of a perforated central capsule, and usually, in addition, a siliceous skeleton : the pseudopods are long and delicate.

Systematic Position of the Example.

Amœba proteus is one of many species of the genus *Amœba*, belonging to the family *Amœbidae*, of the order *Lobosa*. The blunt pseudopods not uniting to form networks place it among the *Lobosa* : the absence of a shell, among the *Amœbidae*. The genus *Amœba* is distinguished by the presence of one or more nuclei, and of a contractile vacuole. In *A. proteus* the pseudopods are of considerable length and sometimes branched, and there is a single nucleus, having its chromatin in the form of scattered granules.

ORDER 1.—LOBOSA.

General Structure.—The members of this group all agree with *Amœba* in essential respects, their most characteristic feature being the short, blunt pseudopods. The chief variations in structure upon which the genera and species are founded have to do with the number and character of the nuclei, the form of the pseudopods, and the presence or absence of a shell.

In *Amœba* itself there may be one (Fig. 30, *E*) or several (*B*) nuclei, the chromatin of the nucleus may be arranged in various

ways (*F. H*), and the pseudopods may be prolongations of considerable relative size (*C*), or mere wave-like elevations of the surface (*G*). Sometimes specimens are found in which neither



FIG. 31.—*Protamoeba primitiva*. Showing changes of form and three stages in binary fission. (After Haeckel, from Parker's *Biology*.)

nucleus nor vacuole is present; these are placed in the genus *Protamoeba* (Fig. 31). This and other non-nucleate forms possess a potential nucleus in the form of minute scattered granules of chromatin (*chromidia*).

The largest of the naked or shell-less Lobosa is *Pelomyxa*, which may be as much as 8 mm. in diameter; it is multi-nucleate and is further distinguished by the presence of numerous non-contractile vacuoles in the endosarc.

Skeleton.—We may understand the relation of the shelled to the shell-less Lobosa by supposing an Amoeba to draw in the pseudopods from the greater part of its body, and to secrete, from that part only, a cell-wall; such a cell-wall or capsule would differ from a cyst in having an aperture at one end to allow of the protrusion of pseudopods from a small naked area. This is exactly what we find in *Arcella* and its allies (Fig. 32, *A C*), in which the shell is chitinoid. A different kind of shell is found in *Diffugia* (*D*), which secretes a gelatinous coating to which minute sand-grains and other foreign particles become attached.

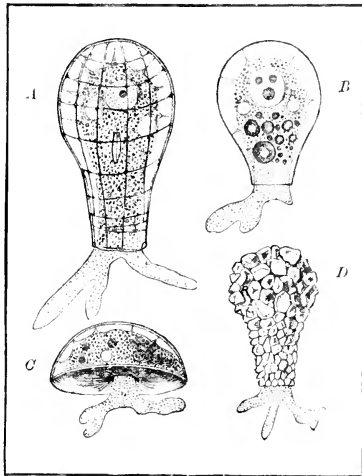

FIG. 32.—*A, Quadrula symmetrica*; *B, Hyalosphenia lata*; *C, Arcella vulgaris*; *D, Diffugia pyriformis*. (From Lang's *Comparative Anatomy*.)

The prevailing mode of **multiplication** is by means of binary fission. But multiple fission also occurs. In such a case the animal passes into the encysted condition, and nucleus and protoplasm

undergo a process of division resulting in the formation of a number of small bodies or *spores* which, when mature, are set free by the rupture of the wall of the cyst. Each of these may develop directly into the adult form. But in some cases it has been found that on becoming free from the cyst they coalesce in pairs either with one another or with similar bodies from other cysts. To such a

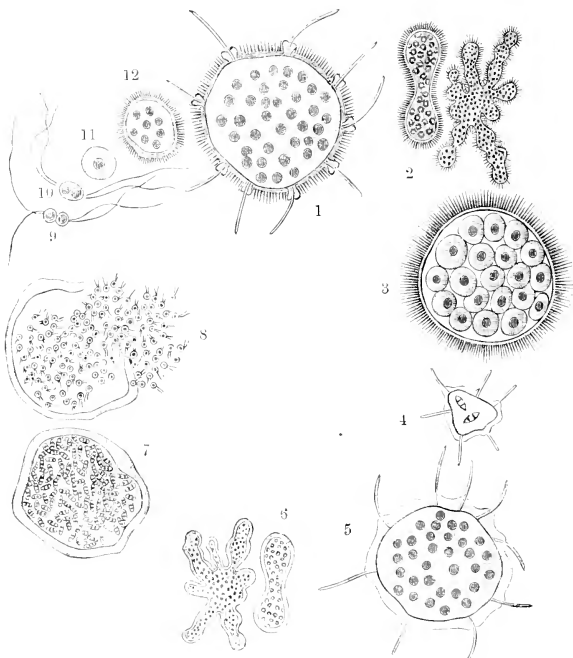

FIG. 33. —*Trichosporium sieboldii*. 1, Adult of "A" form; 2, its multiplication by fission and gemmation; 3, division into amoeboid spores; 4, development of one of these into "B" form (5); 6, its multiplication by fission and gemmation; 7, its division into numerous minute bodies; 8, discharge of these as biflagellate gametes; 9, 10, copulation, more highly magnified; 11, zygote; 12, transition towards "A" form. (After Schaudinn.)

coalescence, which extends to the two nuclei as well as the cytoplasm, the term *copulation* is applied—the two copulating bodies being *gametes* and the body resulting from the union a *zygote*. This is the simplest form of sexual reproduction. A slight complication is introduced when, as in *Amœba blattæ*, there are two sets of gametes to be distinguished—a larger and a smaller—and copulation

takes place between one of the former and one of the latter. In *Paramœba*, which is amœboid in the adult condition and multiplies by binary fission, when encystation takes place the contents of the cyst become divided up to form *flagellulae*, each provided with two flagella. These are not known to copulate, but multiply by binary fission and pass directly into the adult amœboid form, the flagella being lost. In *Trichosphaerium* (Fig. 33) there is an alternation of generations—one generation (1, 2) reproducing by fission and gemmation and then breaking up into amœboid spores (3) which do not copulate but develop (4) directly into the second generation (5), and this after reproducing by fission and gemmation (6), becomes resolved into bi-flagellate gametes (7, 8), which copulate in pairs with other similar gametes (9, 10, 11), the zygotes developing into the first

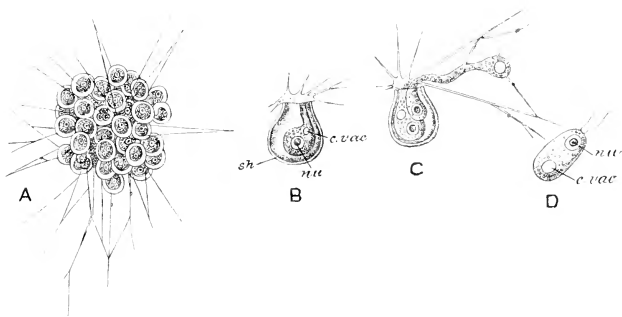

FIG. 34.—*Microgromia socialis*. A, entire colony; B, single zooid; C, zooid which has undergone binary fission, with one of the daughter-cells creeping out of the shell; D, flagellula; c. vac. contractile vacuole; nu. nucleus; sh. shell. (From Bütschli's *Protozoa*, after Hertwig and Lesser.)

generation (1.). In some cases copulation takes place, not between specially produced gametes, but between adults; this is usually followed either by more active multiplication or by passing into a motionless resting condition. A modification of copulation termed *autogamy* occurs in *Amœba coli* (as in a number of Protozoa of other classes). In autogamy the Protozoan divides into two: each of the two nuclei throws off a part of its substance and then unites with the other.

Most of the Lobosa are free; some occurring in fresh water, others in the soil, others in the sea. But a number are parasites in the bodies of higher animals. About six species of *Amœba* are known to occur as parasites in man, of which number, one—*Amœba* (*Entamœba*) *histolytica*—has been proved to be pathogenic, causing dysentery and liver abscess.

ORDER 2.—FILOSA.

The order Filosa comprises a small number of Rhizopods having affinities with some of the Lobosa on the one hand and with the Foraminifera on the other. The pseudopodia are very fine and thread-like, and become branched towards the ends: unlike those of the Foraminifera, they do not coalesce with one another except at or near the proximal ends and do not form networks. There is no clear exoplasmic layer. The best known of the Filosa—*Euglypha*—has a flask-shaped test composed of close-fitting hexagonal siliceous plates.

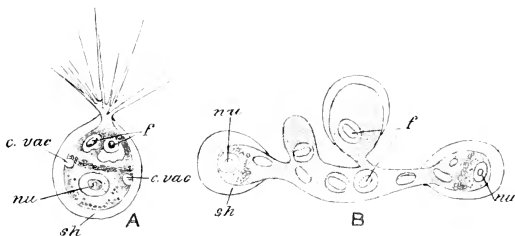

FIG. 35.—*Chlamydomphrys stercorea*. A, single zooid; B, formation of colony; *c. vac.*, contractile vacuole; *f.*, food particles; *nu.*, nucleus; *sh.*, shell. (From Bütschli's *Protozoa*, after Cienkowski.)

ORDER 3.—FORAMINIFERA.

General Structure.—The members of this order differ from the Lobosa in the fact that their pseudopods are long and delicate and unite to form networks; moreover, with few exceptions, they agree with *Arcella* and its allies in possessing a shell. In the majority of cases this shell is formed of calcium carbonate.

One of the simplest members of the group is *Microgromia* (Fig. 34). It consists of a protoplasmic body (*B*), with a single nucleus (*nu.*) and contractile vacuole (*c. vac.*), enclosed in a chitinous cell-wall or shell (*sh.*) with an aperture at one end through which the protoplasm protrudes and is produced into delicate radiating pseudopods. The animal multiplies by binary fission, and the individuals or *zooids* thus produced remain united in larger or smaller clusters, or cell-colonies (*A*). Sometimes the cell-body of a zooid divides and one of the daughter-cells creeps out of the cell-wall (*C*), and, after moving about for a time like an *Amœba*, draws in its pseudopods, assumes an oval form, and sends out two flagella by means of which it is propelled through the water (*D*).

We shall find other instances in which the young of a Rhizopod is a *flagellula*, i.e. a cell provided with one or more flagella, which,

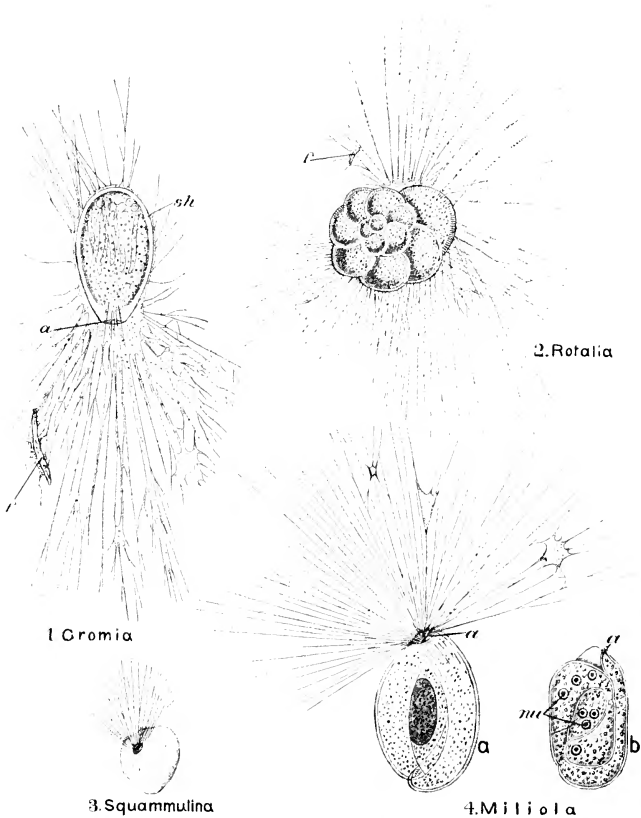

FIG. 36.—Various forms of **Foraminifera**. In 4, *Miliola*, *a*, shows the living animal; *b*, the same killed and stained; *a*, aperture of shell; *f*, food particles; *nu*, nucleus; *sh*, shell. (From Bütschli's *Protozoa* and Claus's *Zoology*.)

if its history were not known, would be included among the Mastigophora.

Chlamydothrys (Fig. 35, *A*) is a form resembling *Microgromia*, but is said to form simple colonies by budding. In the simple

condition it has a chitinous shell with a single narrow opening: it multiplies by binary fission, and by multiple fission produces gametes which copulate.

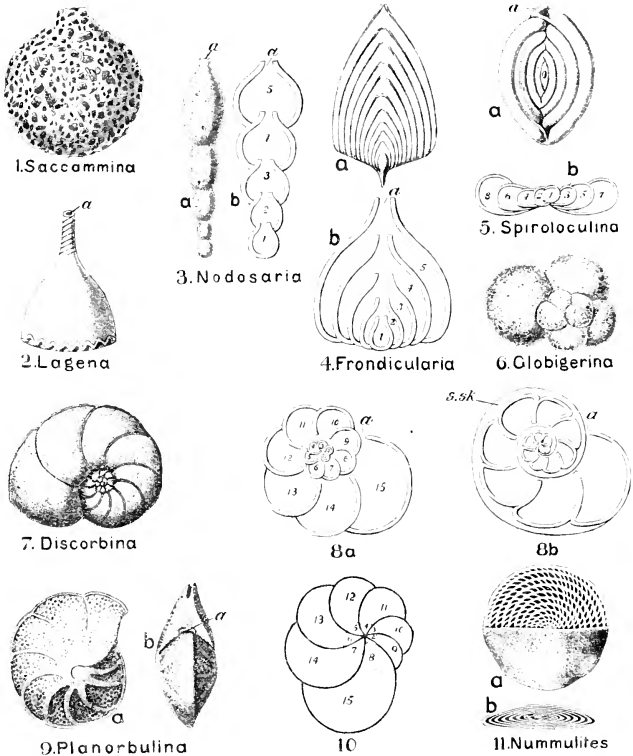

FIG. 37.—Shells of **Foraminifera**. In 3, 1 and 5, *a* shows the surface view, and *b* a section; *8a* is a diagram of a coiled cell without supplemental skeleton; *8b* of a similar form with supplemental skeleton (*s. sk.*); and *10* of a form with overlapping whorls; in *11a* half the shell is shown in horizontal section; *b* is a vertical section; *a*, aperture of shell; 1—15 successive chambers, 1 being always the oldest or initial chamber. (After Carpenter, Brady, and Bütschli.)

Gromia (Fig. 36, 1) leads us to the more typical Foraminifera. The protoplasm of this form protrudes from the mouth (*a*) of the chitinous shell (*sh.*) and flows around it so that the shell becomes an internal structure. The pseudopods are very long and delicate

and unite to form a complicated network, exhibiting a streaming movement of granules and serving, as usual, to capture prey.

Skeleton.—*Squamulina* (Fig. 36, 3) differs from *Gromia* mainly in having the shell formed of calcium carbonate and possessing the character of a hollow, stony sphere, with an aperture at one end. It appears that all the calcareous Foraminifera begin life in this simple form; but in the majority of cases the adult structure attains a considerable degree of complexity. The protoplasm of the original globular chamber overflows, as it were, through the aperture; and the extruded mass rounds itself off, and secretes a calcareous shell in organic connection with the original shell, and communicating with it by the original aperture. In this way a two-chambered shell is produced, and a repeti-

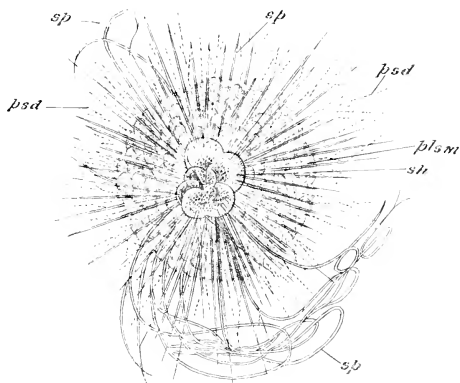

FIG. 38.—*Hastigerina murrayi*. *pls*, vacuolated protoplasm surrounding shell; *psd*, pseudopods; *sh*, shell; *sp*, spines. (After Brady.)

tion of the process gives us the many-chambered shell found in most genera. New chambers may be added in a straight line (Fig. 37, 3), or alternately on opposite sides of the original chamber (5), or with each new chamber enclosing its predecessor (4), or in a flat spiral, each new chamber being larger than its predecessor (7, 8), or in a spire in which the newer chambers overlap the older (9, 10), or in an irregular spiral of globular chambers (6), or in an extremely compact spiral in which the new chambers completely enclose their predecessors (11). In all cases adjacent chambers communicate with one another either by a single large hole or by numerous small ones: the protoplasm is thus perfectly continuous throughout the organism. With the

increase in the number of chambers there is a multiplication of the nucleus (Fig. 36, 4, b, *nu*).

The shell presents two leading types of structure apart from the form and arrangement of the chambers: either it is of a dense porcelain-like texture and provided with a single terminal aperture (*imperforate*, Fig. 36, 4), or the texture is more open and the whole shell is perforated with very minute apertures, through which, as well as through the terminal aperture, pseudopods are protruded (*perforate*, Fig. 36, 2).

In many cases additional complexity is attained by the development of an elaborate canal system in the more complicated perforate forms, and, in certain cases, of what is called the *supplemental skeleton* (Fig. 37, 8b, *s. sk.*). This consists of a deposit of calcium carbonate outside the original shell; it is traversed by a complex system of canals containing protoplasm and is sometimes produced into large spines. Foraminifera in which this secondary skeleton occurs are sometimes of considerable size—2–3 cm. in diameter—and of extraordinary complexity.

Many Foraminifera resemble Diffugia in having a skeleton formed of sand-grains, sponge-spicules, and other foreign bodies cemented together by a secretion from the protoplasm (Fig. 37, 1). Some of these are formed on the imperforate type, having the protoplasm protruded from a single terminal aperture; others on the perforate type, small pseudopods being protruded between the particles forming the shell.

In many cases the pseudopods are the only portions of protoplasm outside the shell, whereas in *Gromia*, as we saw, the shell is invested with a layer of protoplasm, and is thus in strictness an internal structure. A similar layer invests the surface in the calcareous forms with perforate shells and gives off pseudopodia in groups. In one of the calcareous forms with perforated spiral shell, called *Hastigerina* (Fig. 38), a very remarkable modification of this condition of things obtains. The shell (*sh.*) is surrounded with a mass of protoplasm (*plsm.*) many times its own diameter, and so full of vacuoles as to present a bubbly or frothy appearance. The shell itself, moreover, in this and allied forms is provided with numerous delicate, hollow, calcareous spines (*sp.*), which are only to be seen in perfect, freshly-caught specimens.

Many Foraminifera exhibit the phenomenon of **dimorphism**: the individuals of a single species occur under two distinct forms (*megaspheric* and *microspheric*) differing from one another in the size of the central chamber, the shape and mode of growth of the succeeding chambers, and the number and size of the nuclei (Fig. 39).

The reproduction of Foraminifera is mainly by spore-formation, with or without copulation. The protoplasm has been observed in some to divide into minute masses which may be amœboid or may be of the nature of flagellulæ—each provided with a

flagellum or a pair of flagella. In some cases the flagellulae have been observed to copulate in pairs. The young may develop shells while

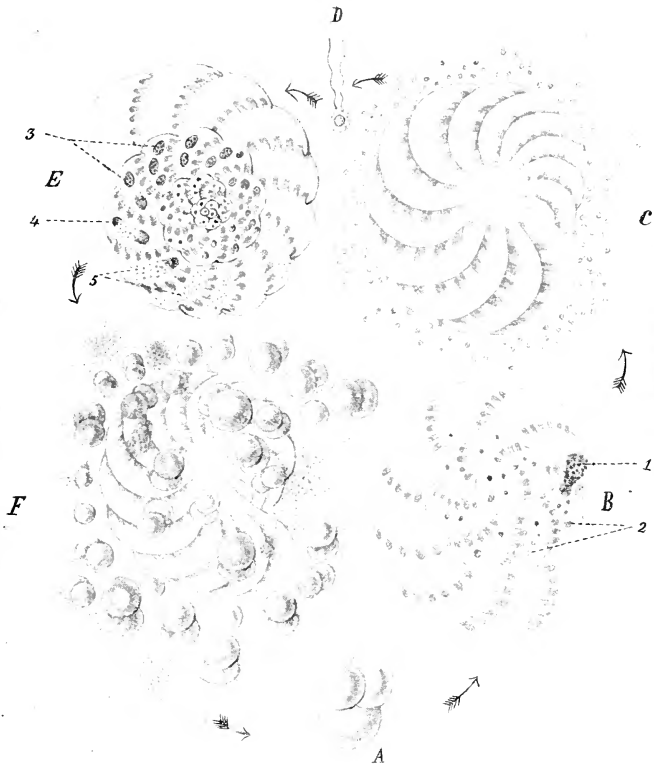

FIG. 39.—Dimorphism and alternation of generations in *Polystomella crispa*. The arrows indicate the direction of the life-cycle. A, young megaspheric individual; B, full-grown megaspheric individual, decciliated; C, mega-spheric individual in the act of sporulation, the protoplasm leaving the shell in the form of flagellulae; D, flagellula more highly magnified; E, microspheric individual developed from a flagellula; F, microspheric individual in the act of producing ameoboid embryos. 1, nucleus; 2, chromidia. (From Lang, after Schaudinn.)

still within the shell of the parent or only after becoming free. In the dimorphic Foraminifera there is evidence of the occurrence of an

alternation of generations (p. 41)—the megaspheric form alternating with the microspheric, and the latter being developed as a result of a process of copulation, the former without it (alternation of sexual and asexual generations).

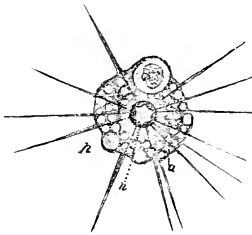

FIG. 40.—*Actinophrys sol.* *a.* axial filaments of pseudopods; *n.* nucleus; *p.* pseudopod. (From Lang's *Comparative Anatomy*, after Grenacher.)

Distribution.—Gromia, Microgromia, and a few other forms are found in fresh water: one species has been found in damp earth, but the great majority of the Foraminifera are marine, some being pelagic, *i.e.* occurring at or near the surface of the ocean, others abyssal, *i.e.* living at great depths.

In the Atlantic, large areas of the sea-bottom are covered with a gray mud called Globigerina-ooze from the vast number of Globigerinæ contained in it.

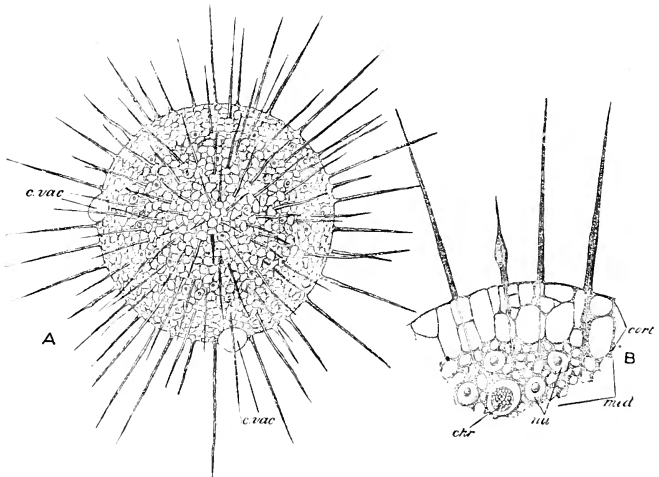

FIG. 41.—*Actinosphaerium eichhornii.* *A.* the entire organism; *B.* a small portion highly magnified; *chr.* chromatophore; *cort.* cortex; *c. vac.* contractile vacuole; *med.* medulla; *nu.* nuclei. (From Bütschli's *Protozoa*, after Hertwig and Lesser.)

From the palæontological point of view, the Foraminifera are a very important group. Remains of their shells occur in various formations from the Silurian period to the present day, certain

rocks, such as the White Chalk (Cretaceous period) and the Nummulitic limestone (Eocene), being largely made up of them.

ORDER 4.—HELIOZOA.

General Structure.—The Heliozoa are at once distinguished from the preceding groups by the character of their pseudopods, which have the form of stiff filaments radiating outwards from the more or less globular cell-body, presenting very little movement beyond the characteristic streaming of granules, and not uniting to form networks.

One of the simplest forms is the common "Sun-animalcule," *Actinophrys sol* (Fig. 40). The body is nearly spherical, and contains a large nucleus and numerous vacuoles, one of which, near the surface, is contractile. Each of the stiff radiating pseudopods has a firm axis, apparently composed of protoplasm, which is traceable through the general protoplasm as far as the nucleus. Living organisms are devoured in much the same way as in *Amœba*: each is ingested along with a droplet of water, and is thus seen, during digestion, to lie in a definite cavity of the protoplasm, called a *food-vacuole*. If the organism be small, processes of the protoplasm are developed, and surround and engulf it. If it be larger, several pseudopods are applied to it, their axial fibres becoming absorbed, and their substance envelops it, enclosing it in a vacuole. The animal can fix itself by means of its pseudopods, the ends of which become viscid, and it is able to crawl slowly by their means. Sometimes it floats freely in the water, and it possesses the power of rising or sinking by some unknown means.

Actinosphærium (Fig. 41, *A*), another fresh-water form, is more complex. The protoplasm is distinctly divided into a central mass, the *medulla* or endosarc (*B, med.*), in which the vacuoles are small, and an outer layer, the *cortex* or ectosarc (*cort.*), in which they are very large. There are numerous nuclei (*nu.*) and chromatophores (*chr.*), the latter coloured green by chlorophyll, the characteristic pigment of green plants. The axial filaments of the pseudopods are in relation each with one of the nuclei.

Many genera form **colonies**. Numerous zooids may be united by bridges of protoplasm into an open network, or the connecting bridges may be shorter and the zooids more numerous, giving the colony a more compact appearance.

There may be two nuclei of different kinds—one centrosome-like body in the centre with the filaments of the pseudopods radiating out from it, and the other a more superficially situated nucleus of ordinary character: the former is derived from the latter.

Transitional stages occur between the naked genera already referred to and forms with a distinct **skeleton**. Sometimes the body simply surrounds itself with a temporary gelatinous investment

(Fig. 42, 2, *g.*), in other cases it is surrounded by a capsule of loosely woven fibres through which the pseudopods pass, thus reminding us of the state of things characteristic of perforate Foraminifera.

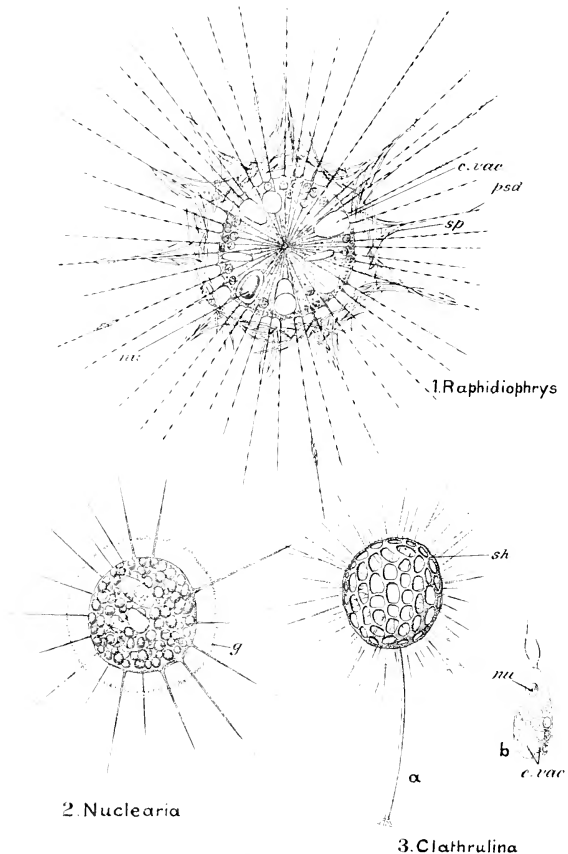

FIG. 12.—Various forms of **Heliozoa**. *1a*, the entire animal; *1b*, the flagellula; *c. vac.*, contractile vacuole; *g*, gelatinous investment; *nu*, nucleus; *psd*, pseudopods; *sk*, siliceous skeleton; *sp*, spicules. (From Bütschli's *Protozoa*, after Schulze and Greeff.)

One genus has a shell formed of agglutinated sand-grains; in another (Fig. 42, 1) the skeleton consists of loosely matted needles of silica. Lastly, in the graceful *Clathrulina* (2) the body is

enclosed in a perforated sphere of silica, quite like the skeleton of many of the Radiolaria (p. 62).

Reproduction ordinarily takes place by binary fission; a peculiar form of budding has been observed, and spore-formation also occurs, with or without encystation. *Actinosphærium*, for instance, encloses itself in a gelatinous cyst and undergoes multiple fission, forming numerous spores each enclosed in a siliceous cell-wall. These *resting spores* remain quiescent throughout the winter, and in spring the protoplasm emerges from each and assumes the form of the ordinary active *Actinosphærium*. In *Clathrulina* spore-formation takes place in the

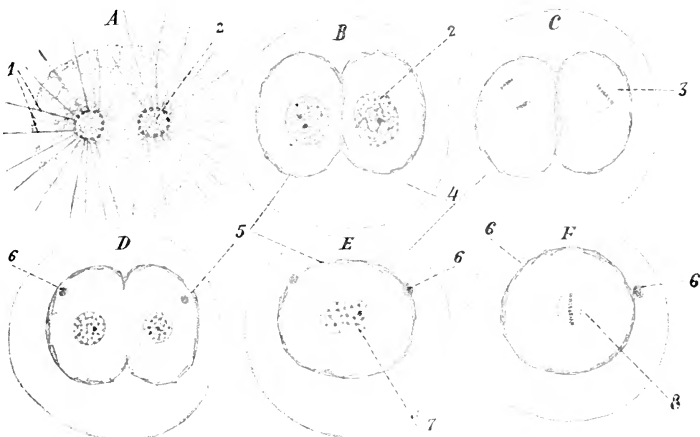

FIG. 43.—*Actinophrys sol*. Conjugation with fusion of nuclei (karyogamy). *A*, two individuals in the first phase of conjugation; *B*, beginning of the encystation; *C*, maturation; *D*, completion of maturation; *E*, coalescence of nuclei; *F*, completion of the first spindle of the zygote resulting from the conjugation. 1, axial filaments of the pseudopods; 2, nucleus; 3, spindles concerned in maturation; 4, 5, outer and inner layers of cyst; 6, polar bodies; 7, nucleus formed by the union of the two nuclei; 8, first (mitotic) division. (From Lang, after Schaudinn.)

active condition, and the spores (Fig. 42, 3 *b*) are flagellulæ, each being an ovoid body provided with two flagella.

*Conjugation*¹ has been observed in some instances between two or more individuals, which may separate again without any nuclear changes taking place; or the conjugation may be followed by a process of copulation, comprising the coalescence of the protoplasm of the two individuals and the coalescence of the nuclei (Fig. 43) after each has given off a part of its substance (*G*), as in the maturation of an ovum in multicellular animals (p. 20). Autogamy (p. 51) also occurs in both *Actinophrys* and *Actinosphærium*.

¹ The term conjugation is here restricted to an association involving close approximation without complete coalescence (copulation).

ORDER 5.—RADIOLARIA.

The Radiolaria are a large and well-defined group of Rhizopods, noticeable, in most instances, by the presence of a siliceous skeleton of great beauty and complexity. They are all marine.

General Structure.—The most important characteristic of the group is the presence of a perforated membranous sac, called the *central capsule* (Fig. 44, *cent. caps.*), which lies embedded in the protoplasm, dividing it into intra-capsular (*int. caps. pr.*) and extra-capsular (*ext. caps. pr.*) regions. In the intra-capsular protoplasm is a large and complex nucleus (*nu.*), or sometimes many nuclei: from the extra-capsular protoplasm the pseudopods (*psd.*) are given off in the form of delicate radiating threads, which in some cases remain free, in others, e.g. *Lithocircus*, anastomose freely, i.e. unite to form networks. In one large section—the *Acantharia*—the pseudopodia, or some of them, contain firm axial rods similar to those in the pseudopods of the Heliozoa. There is no contractile vacuole, but in many forms the extra-capsular protoplasm contains

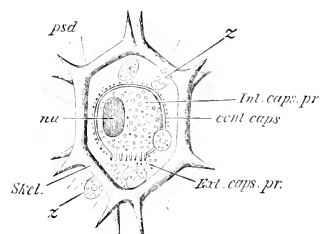

FIG. 44.—*Lithocircus annularis*. *cent. caps.*, central capsule; *ext. caps. pr.*, extra-capsular protoplasm; *int. caps. pr.*, intra-capsular protoplasm; *nu.*, nucleus; *psd.*, pseudopods; *skel.*, skeleton; *z.*, cells of Zooxanthella. (After Bütschli, from Parker's *Biology*.)

numerous large non-contractile vacuoles, which give it the frothy or bubbly appearance noticed previously in *Hastigerina*. The vacuolated portion of the protoplasm has a gelatinous consistency, and is distinguished as the *calymma*. In the *Acanthometridæ* a gelatinous sheath formed of an extension of the calymma invests the spicules of the skeleton.

The **central capsule** may be looked upon as a chitinous internal skeleton, reminding us of the shell of *Gromia* and of the perforated calcareous shell of *Hastigerina* with its investment of vacuolated protoplasm. It is found in its simplest form in *Thalassoplaneta* (Fig. 45), in which it is spherical and uniformly perforated with minute holes. In other forms, such as *Lithocircus* (Fig. 44), it is more or less conical in form, and the apertures are restricted to the flat base of the cone. Lastly, in the most complex forms (Fig. 46), the membrane of the capsule is double, and there are three apertures—a principal one having a central position and provided with a lid or *operculum* (*op.*), and two subsidiary ones on the opposite side. In relation with the principal or lidded aperture there is found in the extra-capsular protoplasm a heap of pigmented matter called the *phæodium* (*ph.*), probably partly of the nature of

excreta. The central capsule encloses, in addition to the nucleus or nuclei, oil-drops, vacuoles, proteid crystals, and pigment.

In some genera the central capsule is the only skeletal structure present, but in most cases there is in addition a **skeleton**—mainly external—formed, as a rule, of silica, but in one subdivision of the class (the *Acantharia*) of a substance called *acanthin*, composed of strontium sulphate, so transparent that it can only be distinguished from silica by chemical tests. The siliceous skeleton may consist of loosely woven spines (Fig. 45), but usually (and the acanthin skeleton always) has the form of a firm frame-work of globular, conical, stellate, or discoid shape, frequently produced into simple or branched spines. In the forms with an acanthin skeleton the spines frequently have inserted into them a number of contractile filaments arising from the gelatinous extra-capsular layer. A very beautiful form of skeleton is exhibited by *Actinomma* (Fig. 47), in which there are three concentric perforated spheres (*A*, *sk. 1*, *sk. 2*, *sk. 3*) connected by radiating spicules. The outer of these spheres occurs in the extra-capsular protoplasm (*B*, *ex. caps. pr.*), the middle one in the intra-capsular protoplasm, and the inner one in the nucleus (*nu.*).

Colonial forms are comparatively rare in this order, but occur in some genera by the central capsule undergoing repeated divisions while the extra-capsular mass remains undivided. In this way is produced—in *Collozoum* for instance (Fig. 48, *A*, *B*, *C*)—a firm gelatinous mass, the calymma or vacuolated extra-capsular protoplasm (*D*, *vac.*) common to the entire colony, having embedded in it numerous central capsules (*c. caps.*) each indicating a zooid of the colony. *Collozoum* may attain a length of 3 or 4 cm.

Reproduction by binary fission has been observed in some cases, and may be universal. The nucleus divides first, then the central capsule, and finally the extra-capsular protoplasm.

Spore-formation has been observed in *Collozoum* and some other genera: the intra-capsular protoplasm divides into small masses, each of which becomes a flagellula (Fig. 48, *E*, *F*) provided with either one or two flagella. In some instances all the spores produced are alike (*E*), and each encloses a small crystal (*c.*): in other cases (*F*)—in the same species—the spores are dimorphic, some being



FIG. 45.—*Thalassoplancta brevispicula*, part of a section. *km*, central capsule; *ip*, intra-capsular protoplasm; *n*, nucleus, containing *nl*, numerous nucleoli; *ot*, oil drops; *ca*, calymma; *cp*, protoplasm surrounding calymma; *s*, spicules. (From Lang's *Comparative Anatomy*, after Haeckel.)

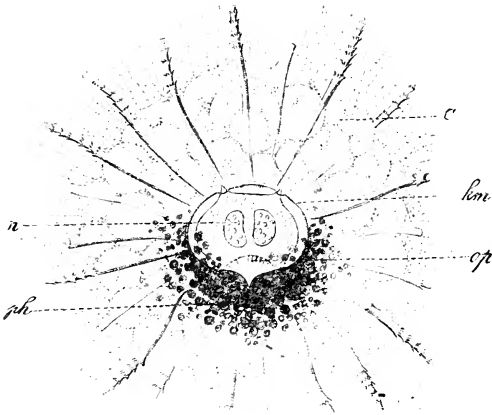

FIG. 16.—**Aulactinium actinastrum.** *c.* calymma; *km.* central capsule; *n.* nucleus; *op.* operculum; *ph.* phaeodium. (From Lang's *Comparative Anatomy*, after Haeckel.)

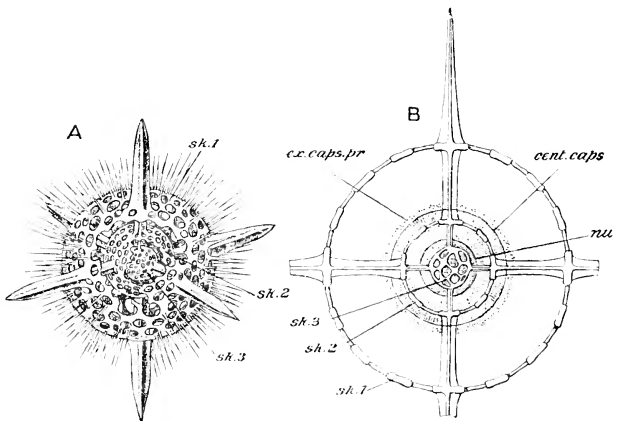

FIG. 47.—**Actinomma asteracanthion.** *A.* the shell with portions of the two outer spheres broken away; *B.* section showing the relations of the skeleton to the animal; *cent. caps.* central capsule; *ex. caps. pr.* extra-capsular protoplasm; *nu.* nucleus; *sk. 1,* outer, *sk. 2,* middle, *sk. 3,* inner sphere of skeleton. (From Bütschli's *Protozoa*, after Haeckel and Hertwig.)

small (*microspores*), others large (*megaspores*). Their development has not been traced; but in all probability the micro- and megaspores are gametes and copulate in pairs.

Symbiosis.—In most Radiolaria there occur in the extra-capsular protoplasm minute yellow cells (Fig. 44, z.), each enclosed in a cell-wall, which multiply by fission independently of the Radiolarian. It has been proved that these are unicellular organisms, sometimes regarded as plants (Class Algæ), sometimes as animals (Class Mastigophora of the Protozoa), and named *Zooxanthellæ*. This intimate association of two organisms is called *symbiosis*: it is probably a mutually beneficial partnership, the Radiolarian supplying the Zooxanthellæ with carbon dioxide and nitrogenous waste matters, while the Zooxanthellæ give off oxygen and produce starch and other food-stuffs, some of which must make their way by diffusion into the protoplasm of the Radiolarian.

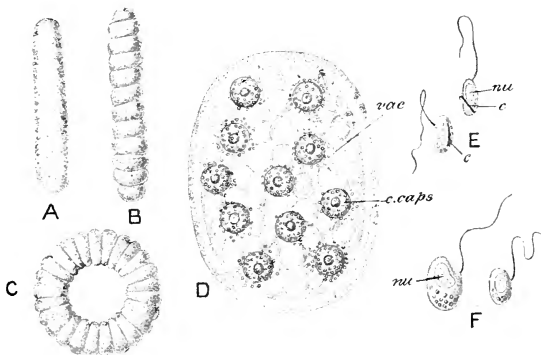

FIG. 48.—*Collozoum inerme*. A—C, three forms of the entire colony, nat. size; D, a small colony showing the numerous central capsules (*c. caps.*) and extra-capsular protoplasm with vacuoles (*vac.*); E, spores containing crystals (*c.*); F, mega- and micro-spore. (From Bütschli's *Protozoa*, after Hertwig and Brandt.)

Though the occurrence of symbiotic Algæ is highly characteristic of the Radiolaria, a similar association has been observed in various other Rhizopods, notably in many Foraminifera. In the Radiolarian order Acantharia, already referred to (p. 63), bodies long regarded as Zooxanthellæ occur mainly in the protoplasm of the central capsule; but these have been shown to be not symbiotes, but parts of the Radiolarian and devoid of cell-wall.

APPENDIX TO THE RHIZOPODA.

CHLAMYDOMYXA AND LABYRINTHULA.

Chlamydomyxa (Fig. 49), of which two species have been described, has been found living on Bog-mosses (*Sphagnum*) in Ireland and in Germany and Switzerland. It may occur either in the active or in the resting condition. In

the latter (*B*, *a*, *b*, *c*) it consists of a mass of protoplasm with a number of nuclei surrounded by a laminated wall of *cellulose*—the substance characteristic of the cell-wall of the typical plant-cell (p. 17). In the protoplasm are numerous non-nucleated protoplasmic bodies or chromatophores, containing chlorophyll and a yellowish-brown colouring matter in varying proportions. There are also a number of minute rounded bodies of a bluish tint probably composed of reserve food-materials. In the young condition

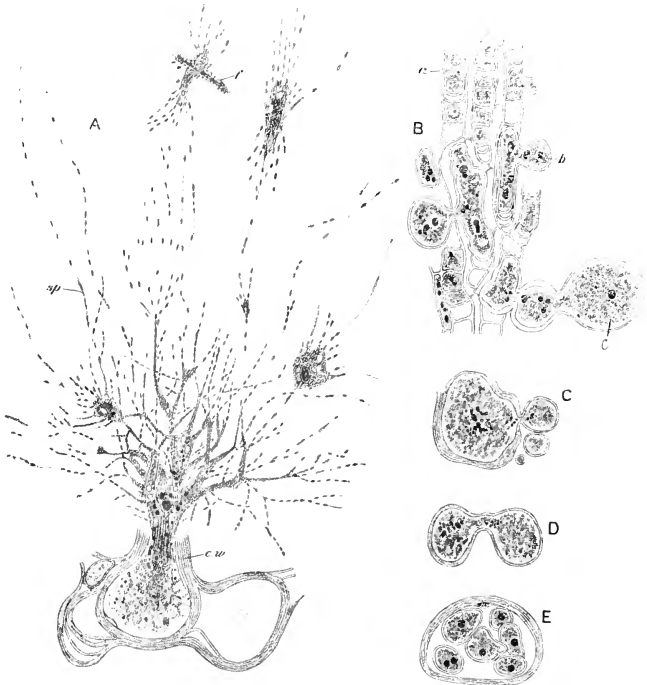

FIG. 49.—*Chlamydomyxa labyrinthuloides*. *A*, active phase; *c.w.* cell-wall; *f.* fragment of Alga ingested as food; *sp.* spindles in course of pseudopods; *B*, resting-stage—numerous individuals in the cells of a fragment of *Sphagnum*; *a*, specimen completely enclosed in cell; *b* and *c*, specimens which have emerged through the ruptured cell-wall; *C*, specimen multiplying by budding; *D*, by binary fission; *E*, by internal fission. *E* may represent a stage in spore-formation. (*A* after Archer, *B*–*E* after Geddes.)

(*a*) the resting cells are globular and microscopic, lying enclosed within the cells of the *Sphagnum*, but as they grow in this confined space they become elongated and irregular, and finally burst through the wall of the moss-cell, forming masses (*b*, *c*) quite visible to the naked eye. These may bud (*C*) or undergo binary fission (*D*); or the protoplasm, retreating from the cell-wall, may divide into numerous small uninucleated amoeboid masses, each of which subsequently surrounds itself with a new cell-wall (*E*).

During the whole of the resting stage there is nothing to distinguish *Chlamydomyxa* from a plant, and it would certainly be placed among the lower Algae if the active phase of its existence were unknown.

In the active stage (*A*) the protoplasm protrudes from the ruptured cell-wall in the form of stiff pseudopods produced into a complex network of extremely delicate filaments, which are much branched and perhaps anastomose, and may unite to form larger masses of protoplasm at a considerable distance from the original cell. At the same time the bluish spheres (*sp.*) found in the resting stage take on a spindle shape and travel slowly along the filaments.

In one of the two known species the protoplasm entirely leaves the cyst-wall and becomes free in the water.

The filaments are used to capture living organisms (*f.*) which are digested by the protoplasm surrounding them, the products of nutrition being conveyed along the network to all parts of the organism. Thus in the active condition the nutrition of *Chlamydomyxa* is *holozoic*, *i.e.* strictly like that of an animal, the food consisting of living protoplasm. In the resting stage, on the other hand, nutrition is purely *holophytic*, *i.e.* like that of an ordinary green

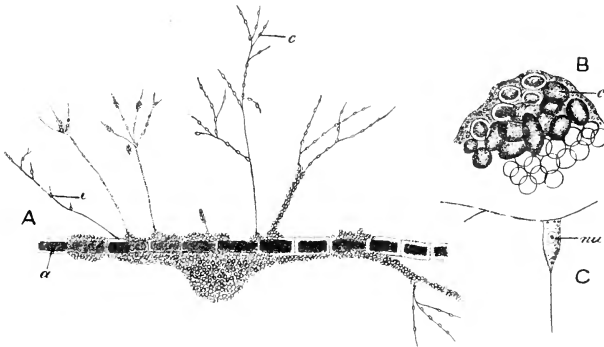

FIG. 50.—*Labyrinthula vitellina*. *A*, specimen crawling on a fragment of Alga (*a.*); *c.* cells travelling in the filaments. *B*, part of specimen in resting condition with heap of cells (*c.*); *C*, a single cell from an actively moving specimen with connecting threads; *nu.* nucleus. (From Bütschli's *Protozoa*, after Cienkowski.)

plant, the food consisting of the carbon dioxide and various mineral salts dissolved in the water. *Chlamydomyxa* multiplies in the resting condition by the formation of spores, each containing two nuclei. These give rise to flagellulæ, the further history of which has not been definitely traced, but there is some evidence that copulation takes place between them.

Labyrinthula (Fig. 50), which lives parasitically on certain marine and fresh-water Algae, in the resting stage (*B*) consists of a heap of small nucleated cells (*c.*) connected by a homogeneous substance. In the active condition (*A*) it is produced into long delicate stiff filaments of pseudopodial character, along which the cells (*c.*) travel, in the same manner as the spindles of *Chlamydomyxa*. *Labyrinthula* has, therefore, the character not of a single cell, but of a *cell-colony*, formed of numerous cells connected together. *Chlamydomyxa*, on the other hand, has the character of a single multinucleate cell. There is thus no close connection between these two aberrant forms: but both may, perhaps, best be regarded as Rhizopoda with nearer relationships to the *Foraminifera* (*Gromia* in particular) than to any of the other orders.

CLASS II.—MYCETOZOA.

I. EXAMPLE OF THE CLASS—*Didymium difforme*.

Didymium occurs as a whitish or yellow sheet of protoplasm (Fig. 51, *G*) often several centimetres across, which crawls, like a gigantic *Amœba*, over the surface of decaying leaves. It shows the characteristic streaming move-

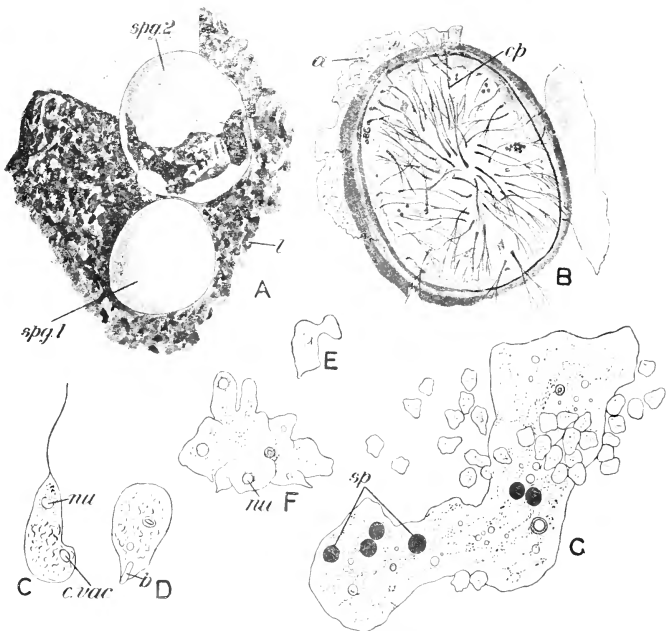

FIG. 51.—*Didymium difforme*. *A*, two sporangia (*spg. 1* and *2*) on a fragment of leaf (*l*). *B*, section of sporangium, with ruptured outer layer (*a*.); and threads of capillitium (*cp*.). *C*, a flagellula with contractile vacuole (*c. vac.*) and nucleus (*nu.*). *D*, the same after loss of flagellum; *b*, an ingested Bacillus. *E*, an amœbula. *F*, conjugation of amœbulae to form a small plasmodium. *G*, a larger plasmodium accompanied by numerous amœbulae; *sp.* ingested spores. (After Lister.)

ments of protoplasm, and feeds by ingesting various organic bodies, notably the Bacilli which always occur in great numbers in decaying substances. Numerous nuclei are present. Certain of these become differentiated as sexual nuclei which throw off a portion of their substance and coalesce in pairs.

After leading an active existence for a longer or shorter time, the protoplasm aggregates into a solid lump, surrounds itself with a cyst, and undergoes multiple fission, dividing into an immense number of minute spores. The cyst (Fig. 51, *A*, *spg. 1*, *spg. 2*) is therefore not a mere resting capsule, like that

of Amœba, but a *sporangium* or spore-case. Its wall consists of two layers, an inner of a dark purple colour and membranous texture, formed of cellulose, and an outer of a pure white hue, formed of calcium carbonate. Thus the whole sporangium, which may attain a diameter of 3 or 4 mm., resembles a minute egg. From the inner surface of the wall of the sporangium spring a number of branched filaments of cellulose, which extend into the cavity among the spores and together constitute the *capillitium* (*B, cp.*).

The spores consist of nucleated masses of protoplasm surrounded by a thick cellulose wall of a dark reddish-brown colour. After a period of rest the protoplasm emerges in the form of an amœboid mass which soon becomes a flagellula (*C*), provided with a single flagellum, a nucleus (*nu.*), and a contractile vacuole (*c. vac.*). The flagellulæ move freely and ingest Bacilli (*D, b.*), and multiply by fission: then, after a time, they become irregular in outline, draw in the flagellum, and become amœboid (*E*). The amœbulæ thus formed congregate in considerable numbers and fuse with one another (*F*), the final result being the production of the great amœboid mass (*G*) with which we started. There is no fusion of the nuclei of the amœbulæ. Thus Didymium in its active condition is a *plasmodium*, *i.e.* a body formed by the condescence of amœbulæ.

2. GENERAL REMARKS ON THE MYCETAZOA.

Generally considered, the Mycetozoa differ from all other Protozoa in their terrestrial habit. They are neither aquatic, like most members of the phylum, nor parasitic, like many other forms, but live habitually a sub-aërial life on decaying organic matter. They are also remarkable for their close resemblance in the structure of the sporangia and spores to certain *Fungi*, a group of parasitic or saprophytic plants in which they are often included, most works on Botany having a section on the *Myxomycetes* or "Slime-fungi," as these organisms are then called. They are placed among animals on account of the structure and physiology of the flagellate, amœboid, and plasmodial phases, which exhibit automatic movements and ingest solid food. The Mycetozoa are sometimes included among the Rhizopoda, a course which their very peculiar reproductive processes appears to render inadvisable.

An interesting organism, called *Protomyxa*, probably belongs to this group. In its plasmodial phase it consists of orange-coloured masses of protoplasm, about 1 mm. in diameter, which crawl over sea-shells by means of their long, branched pseudopods, and ingest living prey. No nuclei are known. The protoplasm becomes encysted and breaks up into naked spores, which escape from the cyst as flagellulæ, but soon become amœboid and fuse to form the plasmodium.

CLASS III.—MASTIGOPHORA

1. EXAMPLE OF THE CLASS—*Euglena viridis*.

Euglena (Fig. 52) is a flagellate organism commonly found in the water of ponds and puddles, to which it imparts a green colour. The body (*A*) is about 0.1 mm. in length, is spindle-shaped, and has at the blunt anterior end a depression, the *gullet* (*A, B, gul.*), from the inner surface of which springs by two roots a single long flagellum (*fl.*). The organism is propelled through the water by the lashing movements of the flagellum, which is always directed forwards; it can also perform slow worm-like movements of contraction and expansion (*C-F*), but anything like the free pseudopodial movements which characterise the Rhizopoda is precluded by the presence of a very thin membrane or cuticle which invests the body. Oblique

and longitudinal lines in the outer layer of the protoplasm are due to the presence of elastic fibrils. There is a nucleus (*nc, nu.*) near the centre of the body, and at the anterior end a contractile vacuole (*A, c.v.*), or more than one, leading into a large non-contractile space or *reservoir (r.)* which discharges into the gullet.

The greater part of the body is coloured green by the characteristic vegetable pigment, chlorophyll, and contains rod-shaped grains of *paramylum (A, p.)*, a carbohydrate allied to starch. In contact with the reservoir is a bright red speck, the *stigma (st.)*, formed of a pigment allied to chlorophyll and called *haematochrome*. It seems probable that the stigma is a light-perceiving organ or rudimentary eye.

Euglena is nourished like a typical green plant: it decomposes the carbon dioxide dissolved in the water, assimilating the carbon and evolving the oxygen. Nitrogen and other elements it absorbs in the form of mineral salts in solution in the water. But it has also been shown

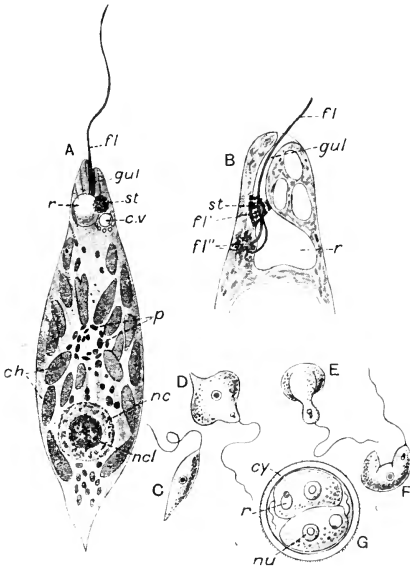

FIG. 52.—*Euglena viridis*. A, view of entire organism, showing details of structure (\times about 1000); B, anterior end, to show origin of flagellum, etc. (\times about 3000); C—F, four views of the living organism, showing the changes of form produced by the characteristic euglenoid movements; G, resting form after binary fission, showing cyst or cell-wall, nuclei, and reservoirs of the daughter-cells; *ch* chromatophores; *c.v.* contractile vacuole; *cy.* cyst or cell-wall; *fl.* flagellum; *fl'*, thickening on flagellum; *fl''*, bifurcate base of flagellum; *gul.* gullet; *nc., nu.* nucleus; *ncl.* "nucleolus"; *p.* paramylum bodies; *r.* reservoir; *st.* eye-spot or stigma. (From Park's *Practical Zoology*.—A, from Doflein; B, from Doflein, after Wager; C—G, after Saville Kent.)

that the movements of the flagellum create a whirlpool by which minute fragments are propelled down the gullet and into the soft internal protoplasm. There seems to be no doubt that in this way minute organisms are taken in as food. Euglena thus combines the characteristically animal (holozoic) with the characteristically vegetable (holophytic) mode of nutrition. But, in all probability,

the *Euglena* is in large measure *saprophytic*, the products of the decay of organic matter dissolved in the water being absorbed through the general surface.

Sometimes the active movements cease, the animal becomes quiescent, numbers of them coming together and secreting a gelatinous scum, in which they lie embedded, on the surface of the water. Each animal surrounds itself with a cyst or cell-wall of cellulose (*G*), from which, after a quiescent period, it emerges to resume active life. It is during the resting condition that reproduction takes place by the division of the body in a median plane parallel to the long axis (*G*). Under certain circumstances multiple fission takes place, and flagellulæ are produced, which, sometimes after passing through an amoeboid stage, develop into the adult form.

2. CLASSIFICATION AND GENERAL ORGANISATION.

The Mastigophora form a very extensive group, the genera and species of which show a wonderful diversity in structure and habit. The only character common to them all is the presence of one or more flagella. Some approach plants so closely as to be claimed by many botanists; others are hardly to be distinguished from Rhizopods; while the members of one order present an interesting likeness to certain peculiar cells found in Sponges.

The class is divisible into four orders as follows:—

ORDER 1.—FLAGELLATA.

Mastigophora having one or more flagella at the anterior end of the body.

ORDER 2.—CHOANOFAGELLATA.

Mastigophora having a single flagellum surrounded at its base by a contractile protoplasmic collar.

ORDER 3.—DINOFAGELLATA.

Mastigophora having two flagella, one anterior, the other encircling the body like a girdle.

ORDER 4.—CYSTOFAGELLATA.

Mastigophora having two flagella, one of which is modified into a long tentacle, while the other is small and contained within the gullet.

Systematic Position of the Example.

Euglena viridis is one of several species of the genus *Euglena*, and belongs to the family *Euglenidæ*, sub-order *Euglenoidea*, and order *Flagellata*.

The presence of an anterior flagellum and the absence of a collar, transverse flagellum, or tentacle, indicate its position among

the Flagellata. It is placed among the Euglenoidea in virtue of possessing a single flagellum and a small gullet into which the reservoir opens. The genus *Euglena* is distinguished by its centrally placed nucleus, green chromatophores, red stigma, and euglenoid movements. *E. viridis* is separated from other species of the genus by its spindle-shaped body with blunt anterior and pointed posterior end, and by the flagellum being somewhat longer than the body.

ORDER 1.—FLAGELLATA.

In the Flagellata the **cell-body** is usually ovoid or flask-shaped (Fig. 53, 6, 7, 9, &c.), but may be almost globular (1), or greatly elongated (3). Anterior and posterior ends are always distinguishable, the flagella being directed forwards in swimming, and, as a rule, dorsal and ventral surfaces can be distinguished by the presence of a mouth or by an additional flagellum on the ventral side. They are, therefore, usually *bilaterally symmetrical*, or divisible into equal and similar right and left halves by a vertical antero-posterior plane.

Some of the lower forms have no distinct cuticle, and are able, under certain circumstances, to assume an amœboid form (2). The curious genus *Mastigamœba* (4) has a permanently amœboid form, but possesses, in addition to pseudopods, a single long flagellum. It obviously connects the Mastigophora with the Rhizopoda, and indeed there seems no reason why it should be placed in the present group rather than with the Lobosa. Similarly, *Dimorpha* (5) connects the Flagellata with the Heliozoa: in its flagellate phase (a) it is ovoid and provided with two flagella, but it may send out long stiff radiating pseudopods, while retaining the flagella, or may draw in the latter and assume a purely helizoan phase of existence provided with pseudopods only (b).

Nuclei of the ordinary character are universally present. In addition there may be present in the cytoplasm at the base of the flagellum or of each flagellum a very much more minute body which is termed the *blepharoplast* (Fig. 54, b), and in close relation to the latter is a secondary nucleus or *kinetoneucleus* (*k.n.*).

The **number of flagella** is subject to great variation. There may be one (Fig. 53, 1-3), two (9, 10), three (6), or four (7). Sometimes the flagella show a differentiation in function; in many cases in which two flagella are present one only is used in progression, the second or ventral flagellum is trailed behind when the animal is swimming freely, or is used to anchor it to various solid bodies. In some (Trypanosomes, Fig. 54) the flagellum (or one of them, if two are present) is attached throughout its length, or in the greater part of its length, to the edge of a wavy protoplasmic flange, or *undulating membrane*, running along the body.

There are also important variations in structure correlated with

varied modes of nutrition. Many of the lower forms, such as *Heteromita*, live in decomposing animal infusions: they have

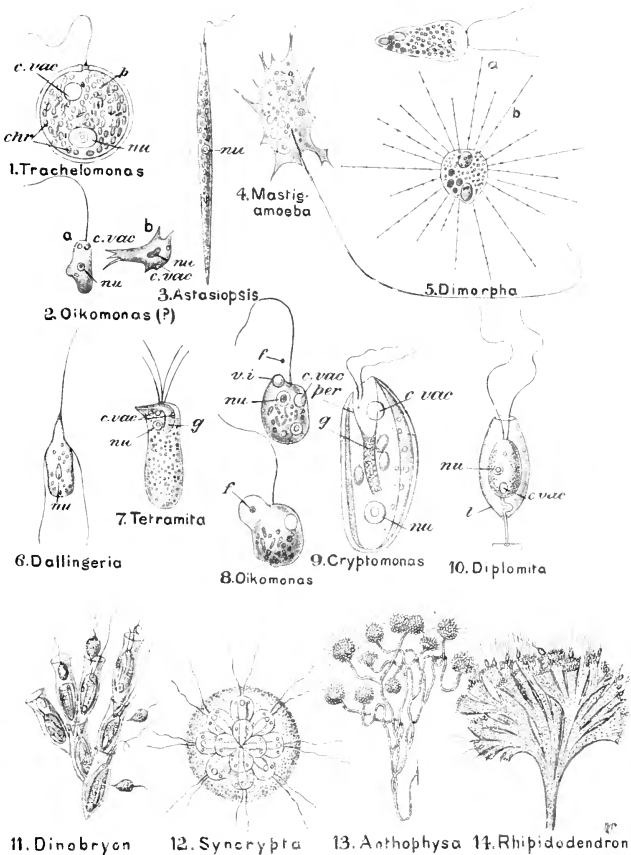

FIG. 53.—Various forms of **Flagellata**. In 2, flagellate (a) and amoeboid (b) phases are shown; in 5, flagellate (a) and heliozoan (b) phases; in 8 are shown two stages in the ingestion of a food-particle (f); chr. chromatophores; c. vac. contractile vacuole; f. food particle; g. gullet; nu. nucleus; l. lorica; per. peristome; v. i. vacuole of ingestion. (Mostly from Bütschli's *Protozoa*, after various authors.)

neither mouth nor gullet and take no solid food, but live by absorbing the nutrient matters in the solution; their nutrition is,

in fact, *saprophytic*, like that of many fungi. A few live as parasites in various cavities of the body of the higher animals. The *Hæmoflagellata* (*Binucleata*), an extensive group, live for the most part as parasites in the plasma of the blood of various vertebrates.

The best known of the *Hæmoflagellata* are the Trypanosomes (Fig. 54). These are long, narrow, flattened Mastigophora, usually pointed at one or both ends, and often spirally twisted. They are provided

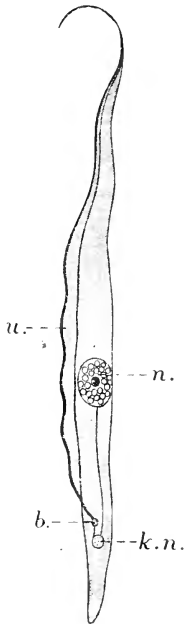

Fig. 54.—A Trypanosome with one flagellum. *b.*, blepharoplast; *k.n.*, kinetoplast; *n.*, primary nucleus; *u.*, undulating membrane. (After Minchin, slightly altered.)

either with one flagellum or with two: when two are present, one is free throughout and directed forwards, the other runs backwards and is attached along the edge of a wavy protoplasmic flange or *undulating membrane* (*u.*); when one is present it may be either the free or the attached one. Each flagellum has at its base a minute centrosome-like granule, the *blepharoplast* (*b.*), and this is connected by a slender thread with a small body of nuclear character, the *kinetoplast* (*k.n.*), which is connected by a thread with the primary nucleus (*n.*) situated towards the middle of the body. Sometimes the blepharoplast is actually situated within the kinetoplast and the flagellum appears to arise directly from the latter. Most of these appear to be harmless, but some are the causes of serious diseases in Man ("sleeping sickness") and other higher animals (tsetse-fly disease in cattle).

Mention may be made here of the *Spirochaetes*, since a connection between them and the Trypanosomes has been supposed to exist. The true *Spirochaetes* (genus *Spirochaeta*), as distinguished from the smaller Trypanosomes on the one hand, and the *Spirilla* (belonging to the *Bacteria*) on the other—with both of which they have been confounded—are non-flagellate, wavy, flexible filaments with an undulating membrane, which multiply by transverse binary fission, and also, apparently, by the breaking up

of the filament into a number of extremely small rounded bodies capable of developing into the adult form. Their affinities appear to be rather with the *Cyanophyceae* (*Oscillatoria*) among the lower plants than with the Protozoa.

Hæmatococcus (Fig. 55), *Pandorina* (Fig. 56), *Volvox* (Fig. 58), and their allies differ somewhat widely from the other Flagellata, and are sometimes regarded as constituting a distinct order

(Phytoflagellata). The mouthless body is surrounded by a cellulose cell-wall (*c.w.*), and contains chromatophores (*chr.*) coloured either green by chlorophyll or red by hæmatochrome. Nutrition is purely holophytic, *i.e.* takes place by the absorption of a watery solution of mineral salts and by the decomposition of carbon dioxide. It is, therefore, not surprising that these chlorophyll-containing Flagellata are often included among the Algæ or lower green plants.

Other genera live in a purely animal fashion by the ingestion of solid proteinaceous food, usually in the form of minute living organisms: in these cases there is always some contrivance for capturing and swallowing the prey. In *Oikomonas* (Fig. 53, *S*) we have one of the simplest arrangements: near the base of the flagellum is a slight projection containing a vacuole (*v.i.*); the movements of the flagellum drive small particles (*f.*) against this region, where the protoplasm is very thin and readily allows the particles to penetrate into the vacuole, where they are digested. In *Euglena*, as we have seen, there is a short, narrow gullet, and in some genera (*g, g*) this tube becomes a large and well-marked structure.

Skeleton.

While a large proportion of genera are naked or covered

only by a thin cuticle, a few fabricate for themselves a delicate chitinoid *shell*, or *lorica* (*l., l.*), usually vase-shaped and widely open at one end so as to allow of the protrusion of the contained animalcule. In most of the chlorophyll-containing forms there is a closed cell-wall of cellulose (Fig. 55, *c.w.*). One group of marine Flagellates (*Silicoflagellata*) have siliceous skeletons similar to those of the Radiolaria, with which they were originally classed.

In many genera colonies of various forms are produced by repeated budding. Some of these are singularly like a zoophyte

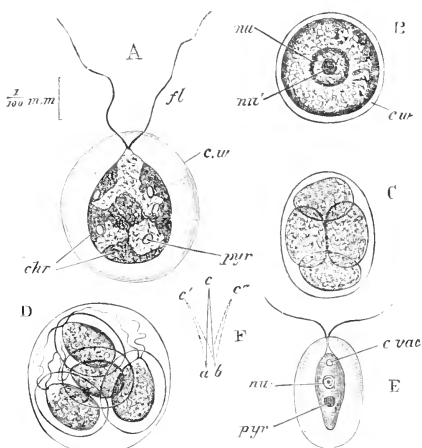

FIG. 55.—*Hæmatococcus pluvialis*. *A*, motile stage; *B*, resting stage; *C, D*, two modes of fission; *E, Hæmatococcus lacustris*, motile stage; *F*, diagram of movements of flagellum; *chr.*, chromatophores; *c. vac.*, contractile vacuole; *c.w.*, cell-wall; *nu.*, nucleus; *nu'*, nucleolus; *pyr.*, pyrenoids. (From Parker's *Biology*.)

(see Sect. IV.) in general form (Fig. 53, 11), being branched colonies composed of a number of connected monads, each enclosed in a little glassy lorica; or green (chlorophyll-containing) zooids are enclosed in a common gelatinous sphere, through which their flagella protrude (12); or tufts of zooids, reminding us of the flower-heads of *Acacia*, are borne on a branched stem (13). In *Volvox* (Fig. 58) the zooids of the colony are arranged in the form of a hollow sphere, and in *Pandorina* (Fig. 56) in that of a solid sphere enclosed in a delicate shell of cellulose. Lastly, in *Rhipidodendron* (Fig. 53, 14) a beautiful branched fan-shaped colony is

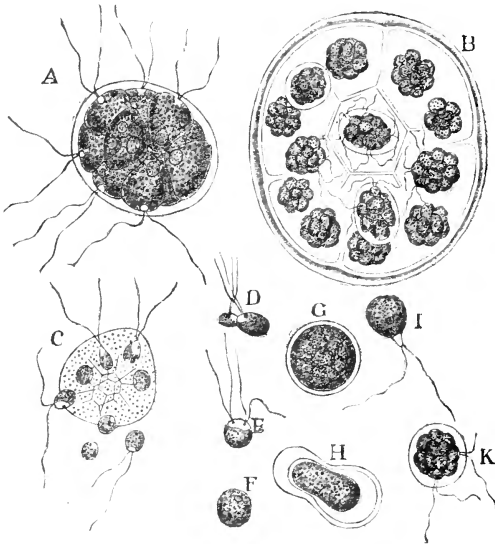

FIG. 56.—*Pandorina morum*. A, entire colony; B, asexual reproduction, each zooid dividing into a daughter-colony; C, liberation of gametes; D—F, three stages in copulation of gametes; G, zygote; H—K, development of zygote into a new colony. (From Parker's *Biology*, after Goebel.)

produced, the branches consisting of closely adpressed gelatinous tubes each the dwelling of a single zooid.

Binary fission is the ordinary mode of **asexual multiplication**, and may take place either in the active or in the resting condition. *Hæmatococcus* (Fig. 55) and *Euglena* (Fig. 52), for instance, divide while in the encysted condition; *Heteromita* and other saprophytic forms while actively swimming: in the latter case the division includes the almost infinitely fine flagellum.

In correspondence with their compound nature, the colonial

genera exhibit certain peculiarities in asexual multiplication. In *Dinobryon* (Fig. 53, 11) a zooid divides within its cup, in which one of the two products of division remains; the other crawls out

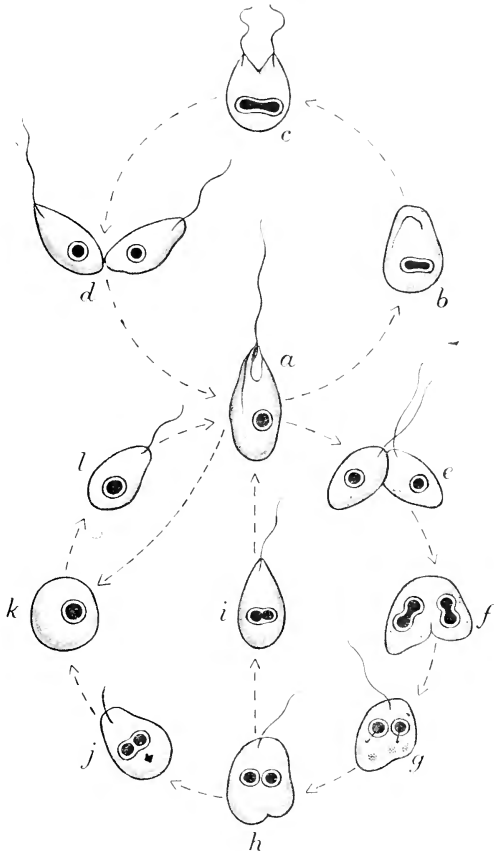

FIG. 57.—*Copromonas subtilis*. a. adult; b, c, d, stages in binary fission; e, f, g, h, i, j, stages in copulation with reduction (f, g) of the nuclei of the copulants, followed by a return to a either directly (i) or through an encysted condition (k). (After Dobell.)

of the lorica, fixes itself upon its edge, and then secretes a new lorica for itself. In *Pandorina* (Fig. 56) each of the sixteen zooids of the colony divides into sixteen (B), thus forming that number of

daughter-colonies within the original cell-wall, by the rupture of which they are finally liberated. In *Volvox* (Fig. 58), certain zooids, called *parthenogonidia* (*A*, *a*), have specially assigned to them the function of asexual reproduction: they divide by a process resembling the segmentation of the egg in the higher animals (D^1 - D^5), and form daughter-colonies which become detached and swim freely in the interior of the mother-colony.

A very interesting series of stages in **sexual reproduction** is found in this group. In a number of cases copulation has been found to occur between ordinary individuals without any special differentiation of gametes. The union of the nuclei (*karyogamy*)

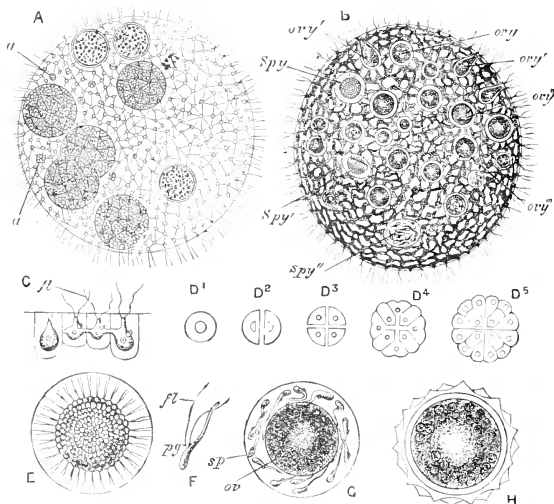

FIG. 58.—*Volvox globator*. *A*, entire colony, enclosing several daughter-colonies; *B*, the same during sexual maturity; *C*, four zooids in optical section; D^1 - D^5 , development of parthenogonidium; *E*, ripe spermary; *F*, sperm; *G*, ovary containing ovum and sperms; *H*, oosperm; *a*, parthenogonidia; *fl*, flagellum; *ov*, ovum; *ovy*, ovaries; *pg*, pigment spot; *spy*, spermatogonia. (From Parker's *Biology*, after Cohn and Kirchner.)

is always preceded in such cases by a reduction of their substance, a process recalling the maturation of the ovum in higher animals (p. 20). *Copromonas* (Fig. 57), which occurs in the fæces of frogs, affords an example of this kind of copulation. Multiplication takes place by binary longitudinal fission (*a-d*). Copulation also takes place with reduction and karyogamy (*e-f*). This is not known to precede any special form of multiplication, but the zygote or its descendants by binary fission may pass into an encysted condition (*k*) in which it is able to survive desiccation.

In *Pandorina* (Fig. 56) the cells of the colony escape from the common gelatinous envelope (*C*) and copulate in pairs (*D, E*), forming a zygote (*F, G*), which, after a period of rest (*H*), divides and forms a new colony (*K*). In some cases the copulating cells are of two sizes, union always taking place between a large cell or *megagamete* and a small cell or *microgamete*. In *Volvox* (Fig. 58) this dimorphism reaches its extreme, producing a condition of things closely resembling what we find in the higher animals. Certain of the zooids enlarge and form megagametes (*B, ovy.*), others divide repeatedly and give rise to groups of microgametes (*B, spy. E, F*), each in the form of an elongated yellow body with a red pigment-spot and two flagella. These are liberated, swim freely, and fuse

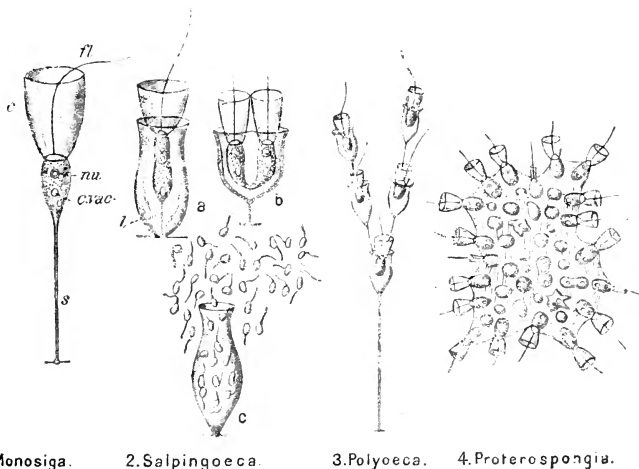

FIG. 59.—Various forms of **Choanoflagellata**. *2b* illustrates longitudinal fission; *2c*, the production of flagellule; *c*, collar; *c. vac.*, contractile vacuole; *fl.*, flagellum; *l.*, lorica; *nu.*, nucleus; *s.*, stalk. (After Saville Kent.)

with the stationary megagamete (*G*), producing a zygote (*H*), which, after a period of rest, divides and reproduces the colony. It is obvious that the megagamete corresponds with the ovum of the higher animals, the microgamete with the sperm, and the zygote with the oosperm or impregnated egg.

ORDER 2.—CHOANOFLAGELLATA.

General Structure.—The members of this group are distinguished by the presence of a vase-like prolongation of the protoplasm, sometimes double, called the *collar* (Fig. 59, *1, c.*), surrounding

the base of the single flagellum (*fl.*). The collar is contractile, and, although its precise functions are not yet certainly known, there is evidence to show that its movements cause vortices in the water which draw in small bodies towards the outside of the collar to which they adhere. By degrees such bodies are drawn towards the base, and each is received into a vacuole which moves back into the interior of the protoplasm, another vacuole taking its place. The animalcule may draw in both collar and flagellum and assume an amœboid form.

The nucleus (*nu.*) is spherical, and there are one or two contractile vacuoles (*c. vac.*), but no trace of mouth or gullet. Some forms are naked (*1*), others (*2*) enclosed in a chitinous shell or lorica of cup-like form. A stalk (*s.*) is usually present in the loricate and sometimes also in the naked forms.

The genera mentioned in the preceding paragraph are all simple, but in other cases colonies are produced by repeated fission. In *Polyæca* (*3*) the colony has a tree-like form, which may reach a high degree of complexity by repeated branching. A totally different mode of aggregation is found in *Proterospongia* (*4*), in which the zooids are enclosed in a common gelatinous matrix of irregular form.

Reproduction.—The “collared monads,” as these organisms are often called, multiply by longitudinal fission (*2b*). In some cases multiple fission of encysted individuals has been observed (*2c*), small simple flagellulæ being produced which gradually develop into the perfect form.

The order is especially interesting from the fact that, with the exception of Sponges, it is the only group in the animal kingdom in which the collar occurs.

ORDER 3.—DINOFLAGELLATA.

The leading features of this group are the arrangement of the two flagella which they always possess, and the usual presence of a remarkable and often very beautiful and complex shell.

The body (Fig. 60, *1*) is usually bilaterally asymmetrical, *i.e.* it may be divided into right and left halves, which are not precisely similar. On the ventral surface is a *longitudinal groove* (*l. gr.*), extending along the anterior half only, and meeting a *transverse groove* (*t. gr.*), which is continued round the body like a girdle. From the longitudinal groove springs a large flagellum (*fl. 1*), which is directed forwards and serves as the chief organ of propulsion; a second flagellum (*fl. 2*) lies in the transverse groove, where its wave-like movements formerly caused it to be mistaken for a ring of small cilia.

The body is covered with a *shell* (*2*) formed of cellulose, sometimes silicified, and often of very complex form, being produced into long and ornamental processes, and marked with stripes, dots, &c. Besides a nucleus, a contractile vacuole and often an eyespot, the protoplasm contains chromatophores (*1, chr.*) coloured with a yellowish or brownish pigment. Nutrition is holophytic or holozoic.

The foregoing description applies to all the commoner genera. *Prorocentrum* (*3*) is remarkable for the absence of the transverse groove, while *Polykrikos* (*4*) has four to eight transverse grooves and no shell. The latter

genus also has *stinging-capsules* or *nematocysts* (*a*, *b*) in the protoplasm, resembling those of *Zoophytes* (see Section IV.), and has numerous nuclei of two sizes, distinguished as *meganuclei* (*nu.*) and *micronuclei* (*nu'*). In the *Adinida* the characteristic grooves are absent.

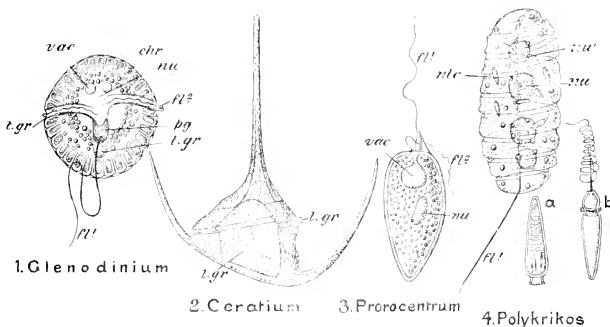

FIG. 60.—Various forms of **Dinoflagellata**. 2 shows the shell only; *4a* is an undischarged, and *b* a discharged stinging-capsule; *chr.* chromatophores; *fl. 1*, longitudinal flagellum; *fl. 2*, transverse flagellum; *l. gr.* longitudinal groove; *ntc.* nematocyst; *nu.* meganucleus; *nu'* micronucleus; *pg.* pigment spot; *t. gr.* transverse groove. (From Bütschli's *Protozoa*.)

Reproduction is, as usual, by binary fission, the process taking place sometimes in a free-swimming individual, sometimes in one which has lost its flagella and come to rest.

The *Dinoflagellata* are mostly marine. Some are phosphorescent. Certain kinds occasionally occur in such abundance in bays and estuaries and in ponds and lakes as to cause a deep brownish or red discoloration of the water.

ORDER 4.—CYSTOFLAGELLATA.

This group includes only two genera, *Noctiluca* and *Leptodiscus*. A description of *Noctiluca miliaris*, the organism to which the diffused phosphorescence of the sea is largely due, will serve to give a fair notion of the leading characteristics of the order.

Noctiluca (Fig. 61) is a nearly globular organism, about $\frac{1}{2}$ mm. in diameter. It is covered with a delicate cuticle, and the medullary protoplasm is greatly vacuolated. On one side is a groove from which springs a very large and stout flagellum or *tentacle* (*bg.*), noticeable for its transverse striation. Near the base of this flagellum is the mouth (*m.*), leading into a short gullet in which is a second flagellum (*f.*), very small in proportion to the first. On the

side opposite to the mouth is a strongly marked superficial ridge. The light-giving region is the cortical protoplasm.

FIG. 61.—**Noctiluca miliaris**. *a.* the adult animal; *b, c.* flagellule; *bg.* tentacle; *f.* flagellum; *m.* mouth; *n.* nucleus. (From Lang.)

Reproduction takes place by binary fission, the nucleus dividing indirectly. Spore-formation also occurs, sometimes preceded by conjugation, sometimes not. The spores (*b, c*), formed by the breaking up of the protoplasm of the parent, escape as flagellulæ.

CLASS IV.—SPOROZOA.

1. EXAMPLE OF THE CLASS—*Monocystis agilis*.

One of the most readily procured Sporozoa is the microscopic worm-like *Monocystis agilis* (Fig. 62, *A*), which is commonly found leading a parasitic life in the vesiculæ seminales of the common

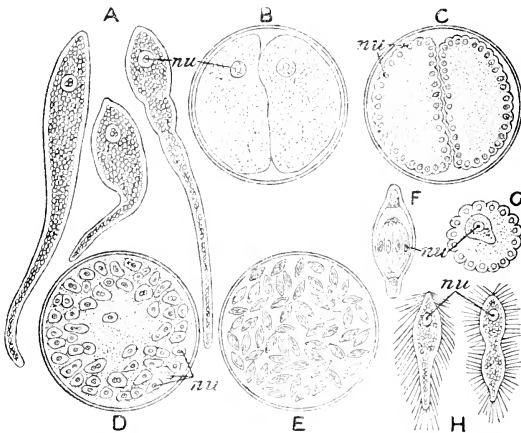

FIG. 62.—*Monocystis*. *A*, Trophozoites in different stages of contraction. *B*, encysted gametocytes. *C*, division of gametocytes into gametes. *D*, conjugation of gametes to form zygotes. *E*, Cyst enclosing ripe spores formed from the zygotes. *F*, single spore, showing the (8) sporozoites in its interior. *G*, group of developing sperm-cells of the earthworm, enclosing a sporozoite in the centre. *H*, young trophozoites still surrounded with the tails of the degenerated sperms. *nu*, nuclei. (From Parker's *Practical Zoology*.)

Earthworm. It is flattened, greatly elongated, pointed at both ends, and performs slow movements of expansion and contraction, reminding us of those of *Euglena*. In this, the *trophozoite* or adult condition, the protoplasmic body is covered with a firm cuticle, and is distinctly divided into a denser superficial portion, the *cortex*, and a central semi-fluid mass, the *medulla*. The innermost layer of the cortex consists of contractile elements or *myonemes* which act like the muscular fibres of higher animals. There is a large clear nucleus (*nu.*) with a distinct nucleolus and nuclear membrane, but the other organs of the protozoan cell-body are absent: there is

no trace of contractile vacuole, of flagella or pseudopods, of mouth or gullet. Nutrition is effected entirely by absorption.

Reproduction takes place by a peculiar and characteristic process of spore-formation. Two individuals come together, and become rounded off and enclosed in a common cyst (*B*), but remain separate. The nucleus of each, after undergoing reduction-changes, divides repeatedly, until a large number of nuclei are formed (*C*). Each of the nuclei becomes surrounded by a thin layer of protoplasm. The minute cells thus formed, after moving to and fro actively for a time, unite in pairs after the substance of the two individuals has become coalescent (*D*). From each of the cells or *zygotes* that are formed by the union of two of the original small cells or *gametes*, a spore is formed, so that the cyst now comes to contain numerous small *spores* (*E*). These are spindle-shaped bodies, each enclosed in a strong chitinous case (*F*), and thus differing in a marked manner from the naked spores of the Rhizopoda and Mastigophora. The protoplasm and nucleus of each spore then undergo fission, becoming divided into a number of somewhat sickle-shaped bodies, the *falciform young* or *sporozoites*, which are arranged within the spore-coat somewhat like a bundle of sausages. In all probability the spores pass through the digestive system of a bird, pass out in its fæces, and only undergo further development if taken into the intestine of an earthworm, when the spore-coat becomes dissolved or ruptured and the sporozoites are set free. From the intestine they are able to migrate freely, and pass to the ciliated funnels of the male reproductive system, entering the cells of the ciliated funnels, in which they are said to live for a time as intracellular parasites, and, after a time escape into the cavity of the vesicula and become lodged in the centre of one of the spherical bodies known as *sperm-morulae*, each made up of a protoplasmic core with an investment of developing sperms (*G*). Ultimately they become free as trophozoites surrounded for a time by degenerating sperms (*H*).

2. CLASSIFICATION AND GENERAL ORGANISATION.

The Sporozoa are exclusively parasitic, being the only group of Protozoa of which this can be said. They have no organs of locomotion and always multiply by spore-formation. The class is divisible into the following five orders:—

ORDER 1.—GREGARINIDA.

Sporozoa in which the trophozoite is free and motile.

ORDER 2.—COCCIDIIDEA.

Sporozoa in which the trophozoite is a minute intracellular parasite.

ORDER 3.—HÆMOSPORIDIA.

Sporozoa in which the trophozoite is amœboid, and lives as a parasite in the coloured blood-corpuscles of Vertebrates.

ORDER 4.—MYXOSPORIDEA.

Sporozoa in which the trophozoite is amœboid, but not intracellular.

ORDER 5.—SARCOCYSTIDEA.

Elongated Sporozoa, usually found in muscle.

Systematic Position of the Example.

Monocystis agilis is a species of the genus *Monocystis*, belonging to the family *Monocystidæ*, of the order *Gregarinida*. It is placed in the *Gregarinida* on account of being free and motile in the trophozoite state. The absence of partitions dividing the protoplasm

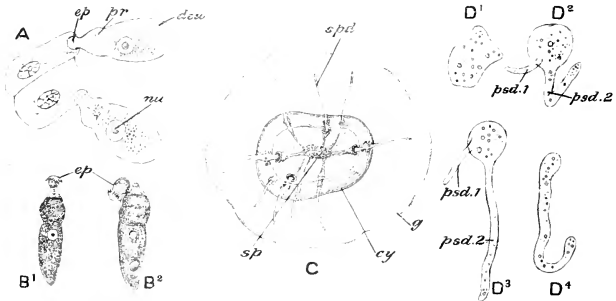

FIG. 63.—*Gregarina*. *A*, two specimens of *G. blattarum* partly embedded in enteric epithelial cells of Cockroach; *B*¹, *B*², two specimens of *G. dujardini*; in *B*² the epimerite (*ep.*) is cast off; *C*, cyst of *G. blattarum*, from which most of the spores have been discharged; *D*, four stages in the development of *G. gigantea*. *cy.* cyst; *deu.* deutomerite; *ep.* epimerite; *g.* gelatinous investment of cyst; *nu.* nucleus; *pr.* protomerite; *psd.* 1, short pseudopod; *psd.* 2, long pseudopod; *sp.* mass of spores; *spd.* sporoducts. (From Bütschli's *Protozoa*.)

into segments indicates its position among the *Monocystidæ*. *Monocystis* is distinguished by its elongated form, by the absence of any special apparatus in the cyst for the liberation and dispersal of the spores, and by its spindle-shaped spores with thickened ends, each producing 4–8 falciform young. The differences between the species of *Monocystis* depend largely upon size.

ORDER 1.—GREGARINIDA.

Monocystis is one of the simpler representatives of the *Gregarinida* as regards both structure and life-history. The structure of the adult or trophozoite is complicated in *Gregarina* (Figs. 63 and 64)

and allied genera by the division of the body into two parts, *protomerite* in front and *deutomerite* behind, by a sort of transverse septum formed by an ingrowth of the layer of myonemes—the nucleus being usually situated in the deutomerite. Sometimes the protomerite is produced in front into a process ending in a rounded enlargement, the *epimerite*, which may be provided with radiating spine-like projections (Fig. 64). When it escapes from the spore the sporozoite in nearly all cases (Fig. 64, 7) enters one of the cells of the epithelium of the alimentary canal of some member of the higher animal phyla, and lives and grows there for a time as an intracellular parasite (8). As it grows it comes to project into the

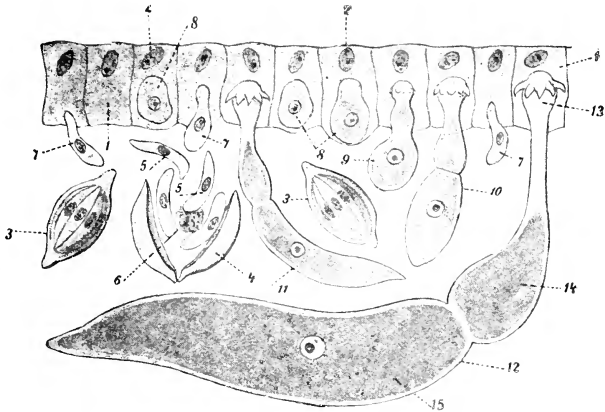

FIG. 64.—*Gregarina*. Development from the sporozoite. 1, cells of the digestive epithelium of the host; 2, nuclei of the same; 3, spore; 4, spore discharging sporozoites (5) leaving residual mass (6); 7, sporozoites in the act of entering epithelial cells; 8, the same as intracellular parasites; 9-12, different stages in the growth of the young *Gregarines* into the lumen of the intestine; 13, epimerite; 14, protomerite; 15, deutomerite. (After Lang.)

cavity of the canal (9, 10, 11, 12), and may eventually become entirely free therein or in the body-cavity, or remain attached to the cell by the epimerite. The formation of spores in *Gregarina* and its allies, as in *Monocystis*, is preceded by the close apposition to one another of two trophozoites and their enclosure in a common cyst. Such conjugating trophozoites in *Gregarina*, as also in *Monocystis*, are not of the nature of gametes: they are cells in which gametes are produced and are appropriately named *gametocytes*. The cells that result from the division of the nuclei and protoplasm of the two associated gametocytes are the true gametes: they copulate, *i.e.* completely coalesce, in pairs, each pair developing into a spore. The two gametes the copulation of which leads to the formation of a spore may be entirely alike; but in some at least of the *Gregariina*

it is possible to distinguish between two sets of gametes which may be looked upon as male and female, copulation taking place between members of the two sets.

The cysts of *Gregarina* (Fig. 63, *C*) are often very complex and provided with delicate ducts (*spd.*) in the thickness of the wall, through which the spores escape. In *Gregarina* (*Porospora*) *gigantea* of the Lobster, the young (*sporozoite*) is liberated from the spore in the form of a non-nucleated amœbula (D^1), with one long and one short pseudopod (D^2); this divides by the long pseudopod (*psd.* 2) becoming separated off, and each product of fission, developing a nucleus, passes into the adult (trophozoite) form (D^3 , D^4). Such a multiplication by fission (*schizogony*) is repeated in such cases through several generations till eventually a generation is formed in which reproduction takes place by spore-formation accompanied by a sexual process. In other cases the sporozoites do not divide, but each develops directly into the trophozoite (Fig. 64).

ORDER 2.—COCCIDIIDEA.

Coccidium (Figs. 65, 66) and allied genera are parasites in the interior of cells, both in Vertebrates and Invertebrates. They live in the cells of various

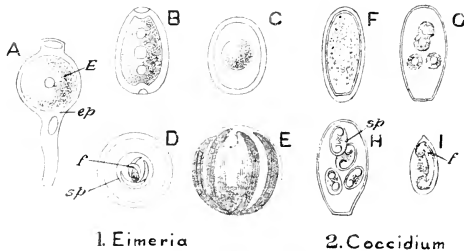

1. *Eimeria*

2. *Coccidium*

FIG. 65.—**Coccidiidea.** A, adult *Eimeria* (E) in enteric epithelial cell (*ep.*) of mouse; B, encysted form; C, encysted form, the protoplasm contracting to form a spore; D, formation of falci-form young (*f.*) in interior of spore (*sp.*); E, spore with falci-form young; F, adult encysted form of *Coccidium* from liver of rabbit; G, division into spores; H, cyst containing ripe spores (*sp.*), each with a single falci-form young; I, single spore with falci-form young (*f.*). (From Bütschli's *Protozoa*, after Leuckart and Eimer.)

zoite, or adult phase, as we may term it, of the parasite, grows to a certain size within the cell without destroying its vitality—the nucleus merely being pushed on one side. So far, in fact, from impairing the nutrition of the cell, the presence of the parasite seems, in some cases, for a time, rather to stimulate it. At a certain stage of growth schizogony (Fig. 66, *b-c*) takes place. The nucleus divides to form a number of nuclei. These migrate towards the surface, and each becomes surrounded by protoplasm, with the result that a number of small cells are formed. Each of these gives rise to a club-shaped *merozoite*. The merozoites, when they become free, are active bodies, which are able to penetrate into the interior of other epithelial cells and develop into trophozoites like those from

organs, most frequently in those of the epithelium of the digestive canal. They never inhabit blood-corpuscles. A few are intranuclear parasites. Two distinct modes of multiplication occur—by *schizogony*, a kind of multiple fission, and by *sporogony*, a process of spore-formation preceded by copulation between male and female cells. The *tropho-*

which they were derived. This multiplication may take place on such an extensive scale that the epithelium may be partially or completely destroyed. It is only, apparently, when such extensive damage has been done, or is threatened, that multiplication by sporogony takes place—the invasion of a



FIG. 66.—Life-history of *Coccidium schubergi*. *a*, penetration of epithelium cell of host by sporozoite; *b-c*, stages of multiple fission (schizogony); *d*, gametocyte; *e, f*, formation of megagamete (ovum); *g*, fertilisation; *h, i*, formation of microgametes (sperms); *k*, development of fertilised ovum into four spores; *l*, formation of two sporozoites (falciform young) in each spore. (From Calkins, after Schaudinn.)

new host being by this process rendered probable, and the continuance of the race being thus provided for in the event of the death of the host in which the epithelium has become destroyed. In this process certain of the merozoites, instead of developing into trophozoites, grow more slowly (*d*), and become

converted into either micro- or mega-gametocytes. Each of the former (*h, j*) gives rise by division to a number of narrow biflagellate microgametes or sperms. Each of the megagametocytes (*e, f*), after a process of the nature of maturation, forms a single rounded megagamete (ovum). When this becomes fertilised by the penetration into it of a single microgamete, the resulting body (*zygote* or *oosperm*) divides to form a varying number of cells each enclosed in

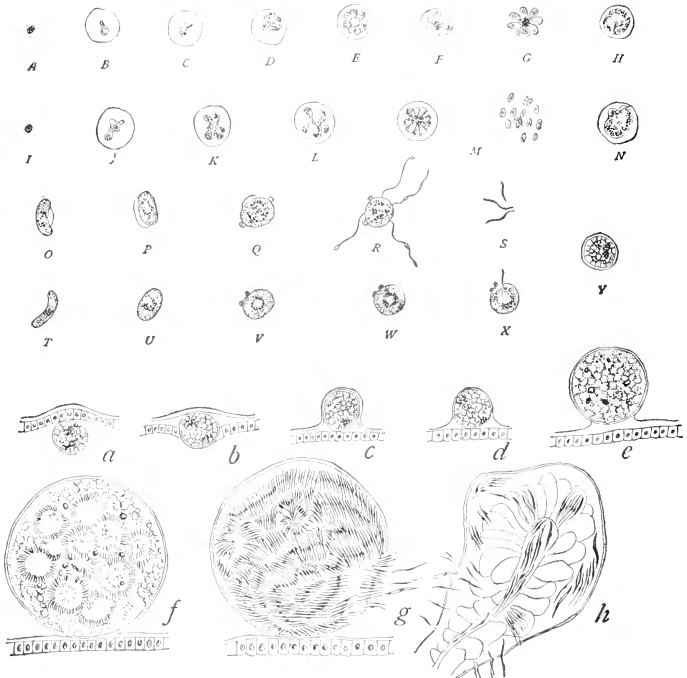

FIG. 67.—Life-history of **Malaria Parasites**. *A-G*, parasite of quartan fever, showing development of trophozoite in a blood-corpuscule and the formation of merozoites; *H*, gametocyte of the same; *I-M*, parasite of tertian fever to the formation of the merozoites; *N*, gametocyte; *O-T*, crescentic gametocytes of *Laverania*; *P-S*, formation of microgametes or sperms; *U-W*, maturation of megagamete or ovum; *X*, fertilisation; *Y*, zygote. *a*, zygote enlarging in stomach of mosquito; *b-c*, passing into the body-cavity; *f, g*, development of the contents into a mass of sporozoites; *h*, sporozoites passing into the salivary glands. (From Calkin's *Protozoa*, after Ross and Fielding Ould.)

a resistant cyst (*h*). These give rise to spores with a firm, chitinous spore-membrane, each containing two or more falciform young or *sporozoites* (*l*). The cyst destroys the cell as it grows, and thus becomes free in the cavity by which the epithelium is lined. The spores may thus pass out to the exterior, and, if taken into the digestive canal of a new host, may liberate the now active sporozoites, which may penetrate into epithelial cells (*a*) to become the trophozoites with which the cycle began.

In some of the Coccidiidea this life-cycle is modified in various ways, as, for example, by the omission of schizogony—the trophozoites in such a case developing directly into gametocytes.

ORDER 3.—HÆMOSPORIDEA.

These are Sporozoa which in the trophozoite condition live as parasites in the interior of the coloured blood-corpuscles of all classes of Vertebrates, but are occasionally found in other cells. In man and in some other mammals and in certain birds it has been found that their presence is the cause of various feverish affections. The various forms of malaria in man have been proved to be due to the presence in the blood-corpuscles of the patient of parasites belonging to this order. The malaria parasites, the history of which has been carefully worked out, pass through a life-cycle comparable to that of *Coccidium* described above. In the trophozoite stage (Fig. 67, A-G) they live as amoeboid intracellular parasites in the interior of the coloured corpuscles of their host. Here they multiply by schizogony—the products (merozoites) entering other corpuscles. Some of the merozoites when they become established in the interior of the corpuscles develop into rounded or crescentic bodies which become the gametocytes (H, N, O, T). In order that the life-cycle may be completed, it is necessary that the parasite at this stage should be taken into the interior of a second or intermediate host. In the case of the parasite of human malaria the intermediate host is a mosquito of the genus *Anopheles*. On the mosquito drawing up a drop of the blood of a malaria patient, all stages of the parasite that occur in it are destroyed by the digestive juices of the insect with the exception of the gametocytes; these survive and form gametes in the stomach of the mosquito. Each male gametocyte gives rise to a number of slender filamentous microgametes (sperms, P, S) and each female gametocyte forms a single megagamete (ovum). After maturation (U-W) the megagamete is fertilised (x) by one of the actively-moving microgametes, the result being the formation of an active spindle-shaped *ookinete* or *vermicule*. This perforates the stomach-wall and comes to rest in the subjacent tissues. It then becomes encysted and increases greatly in size, bulging out into the body-cavity (b-e). The contents of the cyst eventually divide up (f, g) into a large number of long, narrow sporozoites. When the cyst becomes ruptured into the body-cavity, these find their way to the salivary glands (h), and thence they may readily be transferred to the blood-system of a human being when the mosquito bites. Penetrating into the interior of coloured corpuscles they reach the trophozoite condition.

The Hæmogregarines, which may most conveniently be referred to here, are Sporozoa which live in the coloured blood-corpuscles of all classes of Vertebrates, but chiefly in Fishes, Amphibians, and Reptiles; but which, unlike the malaria parasites, in the mature or trophozoite condition are not amoeboid, retaining the Gregarina-like form. Transference from one host to another is effected by means of various blood-sucking Invertebrates.

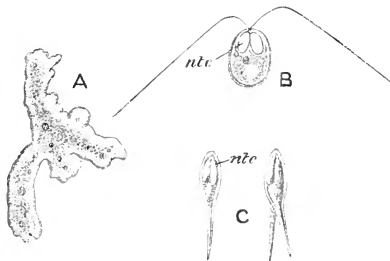

FIG. 68.—A, *Myxidium lieberkühnii*, amoeboid phase; B, *Myxobolus mülleri*, spore with discharged nematocysts (ntc.); C, spores (psorosperms) of a Myxosporidian; ntc, nematocysts. (From Bütschli's *Protozoa*.)

ORDER 4.—MYXOSPORIDEA.

This group includes a small number of genera which are amœboid in the trophozoite phase, and which reproduce continuously by spore-formation during that phase (Fig. 68, *A*). Many nuclei are present in the amœboid body, which may be of comparatively large size. The spores (*B*) produced within the protoplasm of the trophozoite are provided each with one or more bodies like the nematocysts of zoophytes and jelly-fish. [See Section IV.] Myxosporidea occur as parasites mainly of fishes and amphibians, but very many occur in various groups of Invertebrates. "Pébrine," the destructive silk-worm disease, is due to the presence of a Sporozoan belonging to this order. A good example of the order is *Myxidium*, found in the urinary bladder of the pike.

ORDER 5.—SARCOCYSTIDEA.

The best-known form of this order is *Sarcocystis* (Fig. 69), which occurs in the flesh of mammals, each parasite having the form of a long spindle embedded



FIG. 69.—*Sarcocystis miescheri*, adult form (*s*) in striped muscle of pig. (From Bütschli's *Protozoa*, after Rainey.)

in a striped muscular fibre. They are often known as *Rainey's* or *Miescher's corpuscles*. The protoplasm divides into spores from which falciform young are liberated.

CLASS V.—INFUSORIA.

1. EXAMPLE OF THE CLASS—*Paramœcium caudatum*.

Structure.—*Paramœcium*, the "slipper-animalcule," is tolerably common in stagnant ponds, organic infusions, &c. The body (Fig. 70) is about $\frac{1}{4}$ mm. in length, somewhat cylindrical, but flattened, with distinct upper and lower or dorsal and ventral surfaces, and anterior and posterior ends, the latter rather more pointed than the former. On the ventral face is a large oblique depression, the *buccal groove* (*buc. gr.*), leading into a short *gullet* (*gul.*), which, as in *Euglena*, ends in the soft internal protoplasm.

The body is covered with small cilia arranged in longitudinal rows and continued down the gullet. The protoplasm is very clearly differentiated into a comparatively dense *cortex* (*cort.*) and a semi-fluid *medulla* (*med.*), and is covered externally by a thin *pellicle* or *cuticle* (*cu.*) which is continued down the gullet. Each of the cilia is connected at its base with a very small basal granule (rendered visible only by special staining of fixed specimens) situated below the pellicle.

In the cortex are found two nuclei, the relations of which are very characteristic. One, distinguished as the *meganucleus* (*nu.*),

is a large ovoid body staining evenly with aniline dyes, which, when it divides, does so directly by a simple process of constriction. The other, called the *micronucleus* (*pa. nu.*), is a very small body closely applied to the meganucleus; when it divides it goes through the complex series of stages characteristic of mitosis (p. 18).

The contractile vacuoles (*c. vac.*) are two in number, and are very readily made out. Each is connected with a series of radiating spindle-shaped cavities in the protoplasm which serve as feeders to it. After the contraction of the vacuole these cavities are seen gradually to fill, apparently receiving water from the surrounding protoplasm: they then contract, discharging the water into the vacuole, the latter rapidly enlarging while they disappear from view; finally the vacuole contracts and discharges its contents externally.

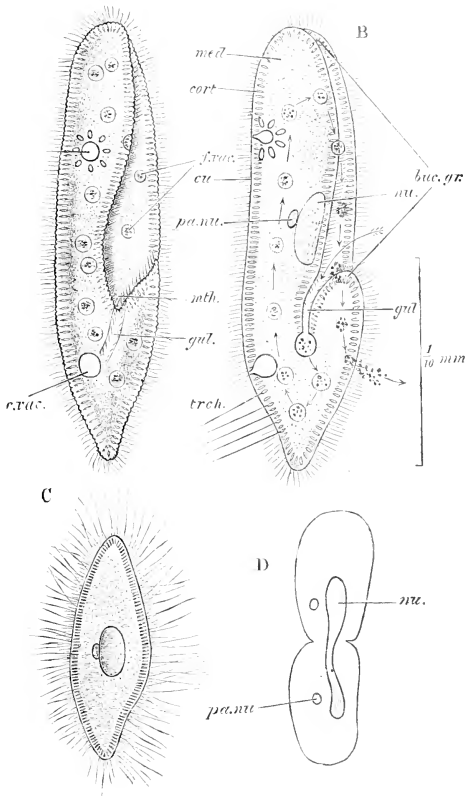

FIG. 70.—*Paramecium caudatum*. *A*, the living animal from the ventral aspect; *B*, the same in optical section: the arrow shows the course taken by food-particles; *C*, a specimen which has discharged its trichocests; *D*, diagram of binary fission; *buc. gr.* buccal groove; *cort.* cortex; *cu.* cuticle; *c. vac.* contractile vacuole; *f. vac.* food vacuole; *gut.* gutlet; *med.* medulla; *nu.* meganucleus; *pa. nu.* micronucleus; *trch.* trichocests. (From Parker's *Biology*.)

The cortex contains minute radially arranged sacs called

trichocysts (*trch.*). When the animal is irritated, more or fewer of these suddenly discharge a long delicate thread. In a specimen killed with iodine or osmic acid the threads can frequently be seen projecting in all directions from the surface (*C*).

Food, in the form of small living organisms, is taken in by means of the current caused by the cilia of the buccal groove. The food-particles, enclosed in a globule of water or "food-vacuole" (*f. vac.*), circulate through the protoplasm, when the soluble parts are gradually digested and assimilated. Starchy and fatty matters, as well as proteids, are available as food, the digestive powers of *Paramœcium* being thus considerably in advance of those of *Amœba*. Effete matters are egested at a definite *anal spot* posterior to the

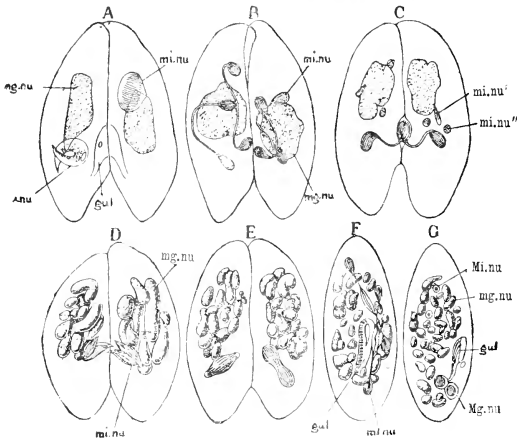

FIG. 71.—*Paramœcium caudatum* stages in conjugation. *gul.* gullet; *mg. nu.* meganucleus; *mi. nu.* micronucleus; *Mg. nu.* reconstructed meganucleus; *Mi. nu.* reconstructed micronucleus. (From Parker's *Ecology*, after Hertwig.)

mouth, where the cortex and cuticle are less resistant than elsewhere. The whole feeding process can readily be observed in this and other Infusoria by placing in the water some insoluble colouring matter, such as carmine or indigo, in a fine state of division.

Reproduction.—Multiplication takes place by transverse binary fission (*D*), the division of the body being preceded by that of both nuclei. As already mentioned, the meganucleus divides directly, the micronucleus indirectly. Fission is never associated with encystation as it is in *Euglena*.

Under certain conditions multiplication by fission is interrupted by *conjugation*. In this very remarkable and characteristic process two *Paramœcia* become applied by their ventral surfaces (Fig. 71, *A*),

but do not fuse. The meganucleus (*mg. nu.*) of each breaks up into small masses, which eventually disappear, being apparently absorbed into the protoplasm. At the same time the micronucleus (*mi. nu.*) of each divides, each product of division immediately dividing again, so that each conjugating body is provided with four micronuclei (*B*). Three of these (*mi. nu'*, *mi. nu''*.) disappear; the fourth divides again into two, of which one is distinguished as the *stationary pronucleus*, the other as the *active pronucleus*. The active pronucleus of each Infusor now passes into the body of the other and fuses with its stationary pronucleus (*D*), each individual thus coming to possess a single nuclear body derived in equal proportions from the two conjugating cells (*E*). The animalcules then separate from one another, and the nucleus of each divides and gives rise to the permanent mega- and micro-nuclei (*G*, *Mg. nu.*, *Mi. nu.*), the original nuclear condition becoming completely established only after the two animals have separated and have twice undergone binary fission.

2. CLASSIFICATION AND GENERAL ORGANISATION.

In the majority of the Infusoria the body is ciliated throughout life, but in certain forms cilia are present only in the immature condition, the adult being provided with peculiar organs of prehension or *tentacles*. We thus get two orders, viz. :—

ORDER 1.—CILIATA.

Infusoria provided with cilia throughout life.

ORDER 2.—TENTACULIFERA.

Infusoria possessing cilia in the young condition, tentacles in the adult.

Systematic Position of the Example.

Paramœcium caudatum is one of several species of the genus *Paramœcium*, belonging to the family *Paramœcidæ*, of the sub-order *Trichostomata*, and order *Ciliata*. The presence of cilia in the adult condition places it among the Ciliata: the presence of a permanently open mouth into which food-particles are swept by the movement of the cilia, among the Trichostomata. The Paramœcidæ are free-swimming, asymmetrical, uniformly ciliated, with a ventrally placed mouth. *P. caudatum* is about $\frac{1}{4}$ — $\frac{1}{5}$ mm. in length, its length about four times its breadth, rounded in front, and bluntly pointed behind, and a single micronucleus is present.

ORDER 1.—CILIATA.

This order presents a wider range of variations—some of them of a truly extraordinary character—than any other group of Protozoa.

The form of the body is very varied: it may be ovoid (Fig. 72, 1), kidney-shaped (2), trumpet-shaped (3), vase- or cup-shaped (4, 9); produced into a long, flexible, neck-like process (5), or into large paired lappets (6); flattened from above downwards, or elongated and divided into segments reminding us of those of a segmented worm (8).

Most species are free-swimming, but some are attached to weeds, stones, &c., by a **stalk**. This may be a purely cuticular structure (9), or may contain a prolongation of the cortex in the form of a delicate contractile *axial fibre* (Figs. 74 and 75, *ax. f.*), which serves to retract the Infusor, its contraction causing the stalk to coil up into a close spiral.

The arrangement of the cilia is also subject to great variation, and presents four chief types. In the *holotrichous* type, of which *Paramecium* is an example, the cilia are all small, equal-sized or nearly so, and arranged in longitudinal rows (Fig. 70, Fig. 72, 1). The second or *heterotrichous* type is seen in its simplest form in *Nyctotherus* (Fig. 72, 2), in which the left side of the peristome is bordered by a row of specially large *adoral* cilia, the rest of the body being covered with small cilia. In *Stentor* (3) the peristome is situated on the broad distal end of the trumpet-shaped body, and the adoral band of cilia takes a spiral course. This leads us to the *peritrichous* type of ciliation: in *Vorticella* (Fig. 74) the vase-shaped body is, for the most part, quite bare of cilia, but around the thickened edge of the peristome passes one limb of a spiral band of large cilia united at their bases, the other limb being continued round a raised lid-like structure, or *disc*, into which the distal region is produced. This arrangement of cilia reaches its greatest complexity in *Epistylis plicatilis* (Fig. 72, 9), in which the ciliary spiral makes no fewer than four turns.

But it is in the *hypotrichous* type that the most extraordinary modifications are found. The flattened body bears on its dorsal surface mere vestiges of cilia in the form of very minute processes, while on the ventral surface the cilia take the form of large hooks, fans, bristles, and plates with fringed ends (Fig. 72, 7). The hooks and plates do not vibrate rhythmically like ordinary cilia, but are moved as a whole at the will of the animal, thus acting as legs. The hypotrichous Ciliata, in fact, in addition to swimming freely in the water, creep over the surface of weeds, &c., very much after the manner of Woodlice. One of the most extraordinary forms in this group is *Diophrys* (7), the size and arrangement of its polymorphic cilia giving it a very grotesque appearance. In another genus (10) the distal end of the flask-shaped body bears a circlet of large fringed cilia, giving the animal the appearance of a Rotifer (*vide* Section VII.).

In addition to cilia, many genera possess delicate sheets of protoplasm or *undulating membranes* in connection with the

peristome. They contract so as to produce a wave-like movement which aids in the ingestion of food. In some cases (Fig. 72, 11) the undulating membrane (*u. mb.*) is a very large and obvious structure.

Certain peculiar forms have yet to be mentioned. *Multicilia* (Fig. 72, 12) has an irregular body of varying form, and bears a small number of very long flagellum-like cilia. Another genus in which the cilia approach to flagella is *Lophomonas* (13), the ovoid body of which bears a tuft of close-set cilia at its anterior end. *Actinobolus* (14) is remarkable for the possession, in addition to cilia, of long retractile tentacles used for attachment. In *Didinium* (15) the barrel-shaped body is encircled by two hoops of cilia.

As we have seen, the **meganucleus** in *Paramœcium* is ovoid: in other genera it may be elongated and band-like (*β, mg. nu.*), horse-shoe-shaped (9), very long and constricted at intervals so as to look like a string of beads (16), or much convoluted and branched (17). In some genera the meganucleus undergoes repeated division, forming at last a very great number of small bodies (*chromidia*) only discoverable by staining: this process of *fragmentation of the nucleus* may proceed so far that the protoplasm of a stained specimen has the appearance of being strewn with granules of chromatin. The discovery of this phenomenon has tended to throw doubt on the reported total absence of a nucleus in some Rhizopods.

In nearly all species one or more **micronuclei** are present, the number sometimes reaching nearly thirty. In *Opalina* (Fig. 76) numerous nuclear bodies (*nu.*) are present, some of which on account of their mitotic mode of division are to be regarded as micronuclei, while the rest are meganuclei.

In *Vorticella* and other peritrichous genera there is a single **contractile vacuole** (Fig. 74, *c. vac.*), which, like that of *Euglena*, opens through the intermediation of a reservoir into the vestibule. In the remaining Ciliata there may be one, two, or many—sometimes a hundred—contractile vacuoles. They may be scattered all over the cortex (Fig. 72, 18), or arranged in one or two rows (8). The star-like arrangement of radiating canals, described in *Paramœcium*, occurs in several genera: or there may be two long canals, or the number of these channels in the protoplasm may reach thirty (19, *c.*). In some instances the protoplasm is hollowed out by numerous **non-contractile vacuoles** (18, *vac.*) so as to have a reticulate appearance, reminding us of the extra-capsular protoplasm of *Radiolaria*.

Trichocysts, like those of *Paramœcium*, are found in many holotrichous forms, but are rarely present in the other subdivisions of the order. In the peritrichous *Epistylis umbellaria*, however, there are found numerous minute capsules (Fig. 72, 9, *ntc.*) arranged in pairs, each containing a coiled thread. They are obviously structures of the same character as trichocysts, and

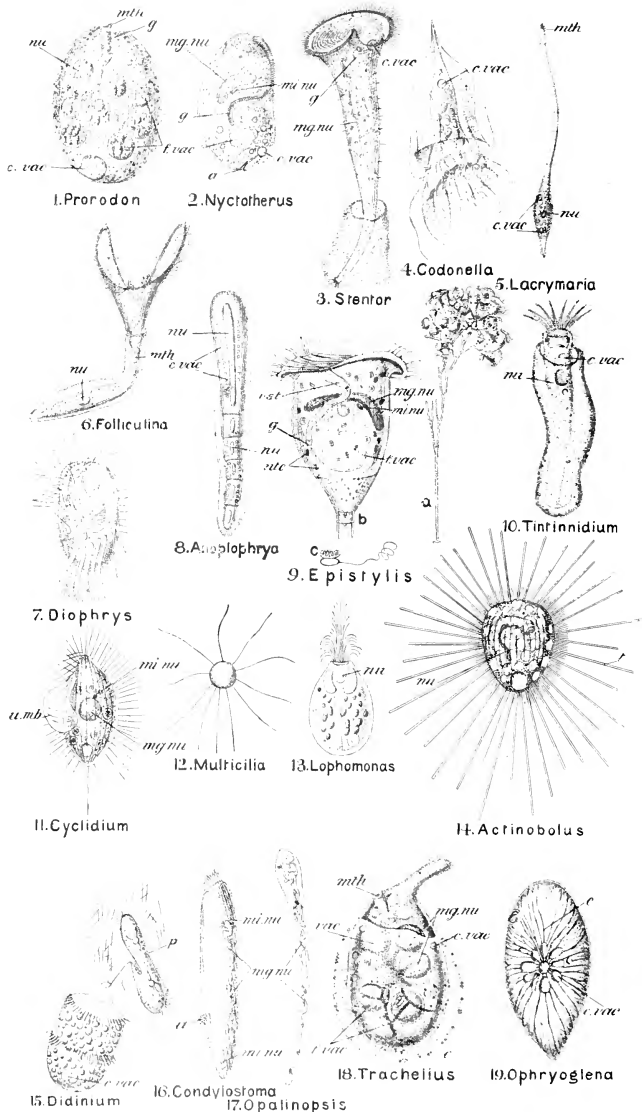

FIG. 72.—Various forms of Ciliata. *9a* shows part of a colony, *b* a single zooid, and *c* a couple of nematocysts; *a*, anus; *c*, (in 18) cuticle; *c. vac.* (in 19) excretory canals; *c. vac.* contractile vacuole; *f. vac.* food vacuole; *g*, gullet; *mg. nu.* meganucleus; *mi. nu.* micronucleus; *mth.* mouth; *nu.* nucleus; *ntc.* nematocyst; *p.* (in 15) a *Paramecium* seized by *Didinium*; *t.* tentacle; *u. mb.* undulating membrane; *vac.* non-contractile vacuole; *vst.* vestibule. (From Bütschli's *Protozoa*, after various authors.)

their resemblance to the *nematocysts* so characteristic of Cœlenterata (*vide* Section IV.) is singularly close.

Digestive Apparatus.—Many parasitic forms (Fig. 72, 8, 17; Fig. 76) have no mouth or gullet, and are nourished by absorption of the digested food in the intestine of their host. The simplest condition of the ingestive apparatus is found in *Prorodon* (Fig. 72, 1) and its allies, in which the mouth (*mt.*) is at one pole of the ovoid body, and is closed except during the ingestion of food, and the gullet (*g.*) is a short, straight tube. Such forms, on account of the symmetrical disposition of their organs and the want of differentiation of their cilia—they are all holotrichous—may be considered as the lowest or least specialised of the Ciliata. From them there is a fairly complete gradation to genera, like *Paramecium*, having the permanently open mouth on the left side

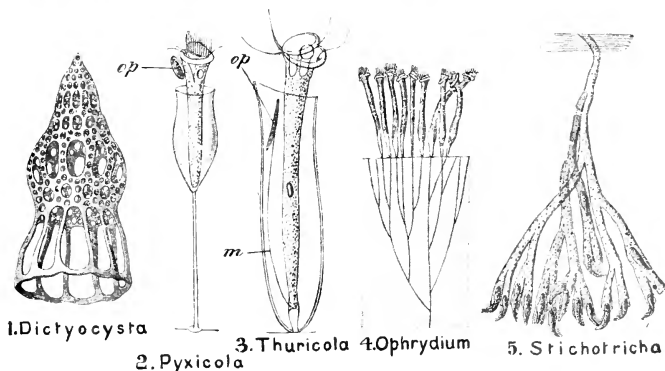

FIG. 73.—Various forms of **Ciliata**. In 1 the shell alone is shown; *m*, contractile fibre; *op*, operculum. (From Bütschli's *Protozoa*, after various authors.)

of the ventral surface, at the end of a well-marked buccal groove or peristome. *Vorticella* (Fig. 74) and its allies are peculiar in having the edge of the peristome (*per.*) thickened so as to form a projecting rim, and in the development of an elevated disc (*d.*) from the area thus enclosed: the mouth (*mt.*) lies between the peristome and the disc, and between it and the gullet proper (*gull.*) is interposed a section of the ingestive tube called the *vestibule* into which the reservoir opens, and which contains the anal spot. In *Nyctotherus* (Fig. 72, 2) and some other genera there is, instead of the temporary anal spot described in *Paramecium*, a distinct *anal aperture* (*a.*).

Most of the Ciliata are naked, having no shell or other form of **skeleton**; but in a few forms the body is provided with a shell or *lorica*, formed of a chitinous material, and reminding us of the

similar structure found in so many of the Mastigophora. Some (Fig. 72, 4) have bell-like shells, variously ornamented, and in others (Fig. 73, 1) the similarly shaped shell is perforated and resembles the skeleton of some of the Radiolaria. A chitinous plate or *operculum* (Fig. 73, 2, *op.*) may be fixed to the edge of the peristome, and, when the animal is retracted in its case, accurately

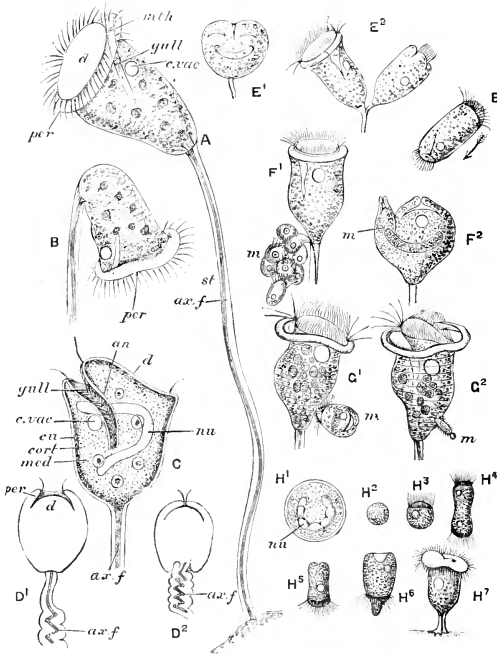

FIG. 71.—*Vorticella*. *A*, *B*, living specimens in different positions; *C*, optical section; *D*¹, *D*², diagrams illustrating coiling of stalk; *E*¹, *E*², two stages in binary fission; *E*³, free zooid; *F*¹, *F*², division into mega- and microzooids; *G*¹, *G*², conjugation; *H*¹, multiple fission of encysted form; *H*², *H*³, *H*⁴, *H*⁵, *H*⁶, *H*⁷, development of spores; *ax.f.* axial fibre; *cort.* cortex; *cu.* cuticle; *c.vac.* contractile vacuole; *d.* disc; *gullet*; *m.* microzooid; *nu.* meganucleus; *per.* peristome. (From Parker's *Biology*.)

closes the mouth of the latter, or a similar operculum (3) is attached to the interior of the tube, and is closed by a contractile thread of protoplasm (*m.*), which acts as a retractor muscle.

Compound forms or **colonies** are common among the Peritricha, rare in the other subdivisions. Many peritrichous forms occur as branched, tree-like colonies, often of great complexity (Fig. 72, 9a; Fig. 75). The stem of these may be a purely cuticular structure

and non-contractile (Fig. 72, 9, *b*), or may contain an axial fibre or muscle, like that of *Vorticella* (Fig. 74, *ax. f.*). In *Ophrydium* (Fig. 73, 4) the colony is an irregular mass, sometimes 4-5 in. in diameter, consisting of a gelatinous substance in which a delicate, branching stem is embedded, each branch terminating in a zooid. Some genera (Fig. 73, 5) secrete a hollow, brown, gelatinous tube, branched dichotomously; the end of each branch is the habitation of one of the zooids.

Reproduction.—*Transverse fission* is the universal method of reproduction, the entire process taking from half an hour to two hours in different species. In *Vorticella* (Fig. 74, *E*) and other *Peritricha* the plane of division is parallel to the long axis of the bell-shaped body. In such simple *Peritricha* as *Vorticella* division proceeds until two zooids are produced on a single stalk; one of the two then acquires a second circlet of cilia near its proximal end, becomes detached (*E*³), and, after leading a free-swimming life for a time, settles down and develops a stalk: in this way the dispersal of the non-locomotive species is ensured.

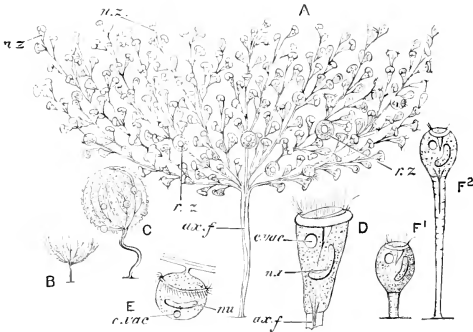

FIG. 75.—*Zoothamnium arbuscula*. A, entire colony; B, the same, natural size; C, the same, retracted; D, nutritive zooid; E, reproductive zooid; F¹, F², development of reproductive zooid; *ax. f.* axial fibre; *c. vac.* contractile vacuole; *nu.* nucleus; *n.z.* nutritive zooid; *r.z.* reproductive zooid. (From Parker's *Biology*, after Saville Kent.)

In many species of *Zoothamnium* (Fig. 75) the zooids are *dimorphic*: the ordinary bell-shaped forms (*n.z.*) divide in the usual way, but as they remain attached, the process results only in the increased complexity of the colony, not in the development of a new one. The larger zooids (*r.z.*) are globular and mouthless: they become detached, swim off, and, after a short free existence, settle down, develop a stalk (*F*), divide, and so form a new colony.

Spore-formation takes place in *Colpoda*. The Infusor becomes encysted, and divides into two, four, and finally eight masses, each of which, becoming surrounded by a special investment, gives rise to a spore. A somewhat similar process has been described in *Vorticella* (Fig. 74, *H*) and others.

A peculiar kind of spore-formation, specially adapted to the requirements of an internal parasite, takes place in *Opalina* (Fig. 76), a parasite in the intestine of the Frog. Binary fission takes place (*D*, *E*, *F*), and is repeated again and again so rapidly that the daughter-cells are unable to grow to the adult size before the next division. The final results of the process are small bodies (*G*), each with only three to six nuclei instead of the large number characteristic of the adult. These become encysted (*H*), and in this passive condition are passed out of the Frog's intestine with its fæces, frequently being deposited on water-weeds. All this takes place during the Frog's breeding season: the tadpoles or Frog-larvæ feed upon the water-plants, and in doing so frequently take in the spores or encysted *Opalinæ* along with their food. When this occurs the cyst is dissolved by the digestive juices of the host, and the protoplasm of the spore is set free and becomes divided up into club-shaped bodies, each with a single nucleus (*I*). These are gametes, which

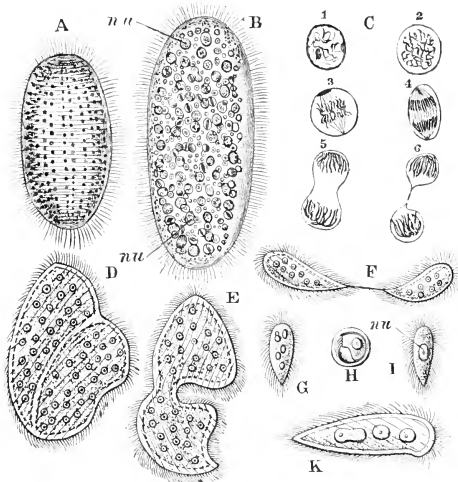

FIG. 76.—*Opalina ranarum*. *A*, living specimen; *B*, stained specimen showing nuclei; *C*, stages in nuclear division; *D*—*E*, stages in fission; *G*, final product of fission; *H*, encysted form; *I*, young form liberated from cyst; *K*, the same after multiplication of the nucleus has begun; *nu*, nucleus. (From Parker's *Biology*, after Saville Kent and Zeller.)

copulate in pairs, the zygotes growing into adult *Opalinæ* (*K*).

Conjugation, in the form of a temporary union accompanied by interchange of micronuclei, has been described in *Paramœcium* (p. 92), and takes place in many *Ciliata*. In others (*e.g.* *Stylonychia histrio*) there is a complete union (*copulation*) of the two gametes. In *Vorticella* union is also permanent, and takes place, not between two ordinary forms, but between one of the ordinary stalked individuals, or megagametes, and a free-swimming, small form, or microgamete, produced a number together from one of the fixed

individuals by a process of multiple fission. After complicated changes in the nuclei of the two conjugating individuals, during which the microgamete contributes a micronucleus towards the formation of the new nuclear apparatus of the megagamete, the former shrivels and dies (G^1 , G^2). The essence of conjugation is the reception of nuclear material derived from another individual: its effect appears to be a renewal of vitality, usually manifesting itself in increased activity in multiplication by fission.

Though most Ciliata are free, many are parasites, mainly in the alimentary canal of various Metazoa. Pathogenic forms are almost unknown.

ORDER 2.—TENTACULIFERA.

Judged from the adult structure alone, the members of this order would certainly be placed in a separate class of the Protozoa: it is only in virtue of the facts of development that they are united in a single class with the Ciliata.

The **body** may be globular (Fig. 77, *1a*), ovoid (*1b*), or cup-shaped (*2a*), but presents nothing like the variety of form met with among the Ciliata. The distinguishing feature of the group is furnished by the **tentacles** which are always present in greater or less number, and which, in some cases at least, are the most highly differentiated organs found in the whole group of Protozoa. The characters of the tentacles vary strikingly in the different genera.

In the common forms *Acineta* (*2*), and *Podophrya* (*1*), the tentacles spring either from the whole surface, or in groups from the angles of the somewhat triangular body. Each tentacle is an elongated cylindrical structure (*1c*), capable of protrusion and retraction, and having its distal end sucker-like. It is, moreover, practically tubular, the axial region consisting of a semi-fluid protoplasm, while the outer portion is tolerably firm and resistant. When partially retracted, a spiral ridge is sometimes observable around the tentacle: this may indicate the presence of a band of specially contractile protoplasm, resembling the axial fibre in the stalk of *Vorticella*. Infusors and other organisms are caught by the tentacles (*4*, *6*), the cuticle of the prey is pierced or dissolved where the sucker touches it, and the semi-fluid protoplasm can then be seen flowing down the tentacle into the body of the captor. A single tentacle only may be present (*3*), or the tentacle may be branched (*4*), the extremity of each branch being suctional. In some forms there are no terminal suckers (*5*), and the tentacles are waved about to catch the prey instead of standing out stiffly as in *Acineta*. In other cases there are one or more long, striated tentacles with tufted ends (*7*).

The **nucleus** may be ovoid (*1a*), horseshoe-shaped, or branched (*8*, *9*): in many cases a micronucleus (*1a*, *mi. nu.*) has been found,

and it probably occurs in all. There are one or more **contractile vacuoles** (*c. vac.*).

Some genera are naked (*1*): others form a stalked **shell** or **lorica** (*2a*) like that met with in many of the Mastigophora.

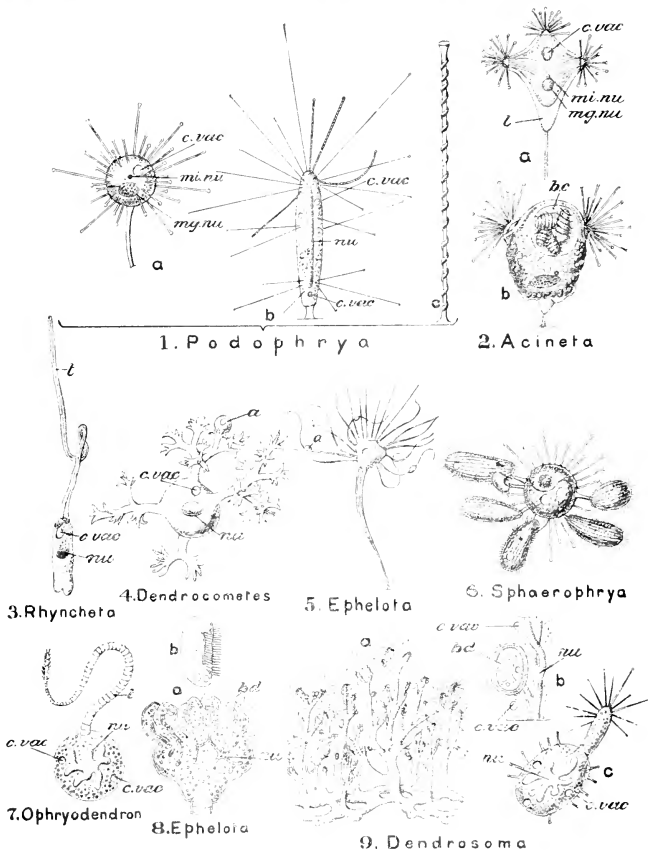

FIG. 77.—Various forms of **Tentaculifera**. *1a* and *b*, two species of *Podophrya*; *c*, a tentacle much enlarged; *2a*, *Acineta jolyi*; *2b*, *A. tuberosa*; in *6* the animal has captured several small Ciliata; *8a*, a specimen multiplying by budding; *8b*, a free ciliated bud; *9a*, the entire colony; *9b*, a portion of the stem; *9c*, a liberated bud; *a*, organism captured as food; *b.c.* brood-cavity; *bd.* bud; *c. vac.* contractile vacuole; *l.* lorica; *mg. nu.* meganucleus; *mi. nu.* micronucleus; *t.* tentacle. (After Bütschli and Saville Kent.)

The only **colonial form** is the wonderful *Dendrosoma* (9), in which the entire colony attains a length of about 2 mm., and bears an extraordinary resemblance to a zoophyte (*vide* Section IV.). It consists of a creeping stem from which vertical branches spring, and the various ramifications of these are terminated in Podophrya-like zooids with suctorial tentacles. The meganucleus is very remarkable, extending as a branched axis throughout the colony (*b, nu.*). Micronuclei of the ordinary character are present as well.

Reproduction by *binary fission* takes place in many species. In *Ephelota gemmipara* (8) a peculiar process of *budding* occurs: the distal end of the organism grows out into a number of projections or buds, into which branches of the nucleus extend. These become detached, acquire cilia on one surface, and swim off (*b*). After a short active existence tentacles appear and the cilia are lost. In this case budding is external, but in *Acineta tuberosa* (2, *3b*) the buds become sunk in a depression, which is finally converted into a closed *brood-cavity* (*b.c.*): in this the buds take on the form of ciliated embryos, which finally escape from the parent. In *Dendrosoma* the common stem of the colony produces internal buds (9, *b, bd.*).

Further Remarks on the Protozoa.

The majority of the Protozoa are aquatic, the phylum being equally well represented in fresh- and salt-water. They occur practically at all heights and depths, from 8,000 to 10,000 feet above sea-level to a depth of from 2,000 to 3,000 fathoms. Some forms, such as species of *Amœba* and *Gromia*, live in damp sand and moss, and may therefore be almost considered as terrestrial organisms. In accordance with their small size and the readiness with which they are transported from place to place, a large proportion of genera and even of species is universally distributed, being found in all parts of the world where the microscopic fauna has been investigated.

Numerous parasitic forms are known. Besides the entire class of Sporozoa, species of Rhizopoda, Mastigophora, and Infusoria occur both as internal and external parasites.

Many instances have been met with in our survey of the Phylum of compound or colonial forms, the existence of which seems at first sight to upset our definition of the Protozoa as unicellular animals. But in all such cases the zooids or unicellular individuals of the colony exhibit a quasi-independence, each, as a rule, feeding, multiplying, and performing all other essential animal functions independently of the rest, so that the only division of labour is in such forms as *Zoothamnium* and *Volvox*, in which certain zooids are incapable of feeding, and are set apart for reproduction. In all animals above Protozoa, on the other hand, the body is formed of an aggregate of cells, some of which

perform one function, some another, and none of which exhibit the independent life of the zooid of a protozoan colony. It cannot, however, be said that there is any absolute distinction between a colony of unicellular zooids and a single multicellular individual: *Proterospongia* and *Volvox* approach very near to the border-land from the protozoan side, and a similar approach in the other direction is made by certain animals known as *Mesozoa*, which will be discussed hereafter (Section IV.). Moreover, the Mycetozoa, the plasmodia of which are formed by the fusion of Amœbulæ, the nuclei of the latter remaining distinct and multiplying, are rather non-cellular than unicellular. This point will also be referred to at the conclusion of the section on Sponges (Section III.).

In each division of the Protozoa we have found comparatively low or generalised forms side by side with comparatively high or specialised genera. For instance, among the Rhizopoda, there can be no hesitation in placing the Lobosa, and especially *Protamoeba*, at the bottom of the list, and the Radiolaria at the top. Similarly, among the Mastigophora, such simple Flagellata as *Oikomonas* (Fig. 53, 2 and 8) are obviously the lowest forms, *Noctiluca* and the Dinoflagellata the highest. But whether the Rhizopoda, as a whole, are higher or lower than the Flagellata is a question by no means easy to answer. A flagellum certainly seems to be a more specialised cell-organ than a pseudopod, and some of the Mastigophora rise above the highest of the Rhizopoda in the possession of a firm cortex and cuticle, and the consequent assumption of a more definite form of body than can possibly be produced by the flowing protoplasm of a Foraminifer or a Radiolarian. On the other hand, the nucleus of the Radiolaria is a far more complex structure than that of the Mastigophora; and in Foraminifera, Radiolaria, and Heliozoa the organism frequently begins life as a flagellula, a fact which, on the hypothesis that the development of the individual recapitulates that of the race, appears to indicate that these orders of Rhizopoda are a more recently developed stock than at any rate the lower Flagellata. These circumstances, and the fact that *Mastigamoeba* might equally well be classed as a lobose Rhizopod with a flagellum or as a Flagellate with pseudopods, seem to indicate that the actual starting-point of the Protozoa was a form capable of assuming either the amœboid or the flagellate phase. From such a starting-point the Lobosa, Foraminifera, Heliozoa, Radiolaria, and Flagellata diverge in different directions, the first four keeping mainly to the amœboid form, but assuming the flagellate form in the young condition in the case of Foraminifera, Heliozoa, and Radiolaria.

The Choanoflagellata, Dinoflagellata, and Cystoflagellata are obviously special developments of the Flagellate type along diverging lines.

As to the Ciliata, *Multicilia* and *Lophomonas* (Fig. 72, 12 and 13) appear to indicate the derivation of the order from the Flagellate type, since their cilia are long and flagellum-like; but the evidence is not strong and no other is at hand. The derivation of the Tentaculifera from a ciliate type appears to be clear. The Tentaculifera and the hypotrichous Ciliata are undoubtedly the highest development of the Protozoan series, since they show a degree of differentiation attained nowhere else by a single cell.

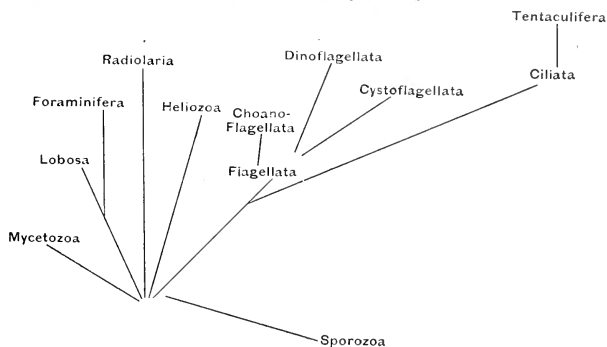

FIG. 78.—Diagram showing the mutual relationships of the chief groups of Protozoa.

The Mycetozoa appear to have been derived from the common amœboid-flagellate stock, since they are all predominantly amœboid in the adult condition, flagellate when young. The Sporozoa probably had a similar origin, but the characters of this class have evidently been profoundly modified in accordance with their parasitic mode of life.

The diagram above is an attempt to express these relationships in a graphic form.

SECTION III

PHYLUM AND CLASS PORIFERA [PARAZOA]

THE microscopic animals described in the preceding section are, as already repeatedly pointed out, characterised by their unicellular character, and in this respect stand in contrast to the remainder of the animal kingdom. The animal kingdom is thus capable of division into two great subdivisions, the *Protozoa* or unicellular animals, and the *Metazoa* or multicellular forms—the latter comprising all the groups that remain to be dealt with. In the earliest stage of their existence all the multicellular animals or *Metazoa* are, as already pointed out (p. 20), in a unicellular condition, originating in a single cell, the fertilised ovum or oosperm. By the process of segmentation or yolk-division the unicellular oosperm becomes converted in all the *Metazoa* into a mass of cells from which the body of the adult animal is eventually built up. Of the *Metazoa*, the group which approximates most closely to the *Protozoa* is that now to be dealt with—the *Porifera* or Sponges. With all the other multicellular groups the Sponges are so strongly in contrast that the *Metazoa* may be regarded as falling into two main divisions—the *Porifera* or *Parazoa*, on the one hand, and all the rest of the *Metazoa*, grouped together as *Enterozoa*, on the other.

1. EXAMPLE OF THE CLASS—*Sycon gelatinosum*.

General External Appearance and Gross Structure.—*Sycon gelatinosum*,¹ one of the Calcareous Sponges, has the form of a tuft, one to three inches long, of branching cylinders (Fig. 79), all connected together at the base, where it is attached to the surface of a rock or other solid body submerged in the sea. It is flexible, though of tolerably firm consistency; in colour it presents various shades of gray or light brown. To the naked eye the surface appears smooth, but when examined under the lens it is found to exhibit a pattern of considerable regularity, formed by the presence of

¹ This species is an inhabitant of southern seas. In all essential respects the account of it given above will apply to *S. ciliatum*, a common European species which differs chiefly in the absence of the pore-membranes.

innumerable elevations of a polygonal shape, which cover the whole surface and are separated off from one another by a system of depressed lines. In these depressions between the elevations are to be detected, under the microscope, groups of minute pores—the *ostia* or inhalant pores.



FIG. 79.—*Sycon gelatinosum*. Entire sponge, consisting of a group of branching cylinders (natural size).

At the free end of each of the cylindrical branches is a small but distinct opening, surrounded by what appears like a delicate fringe. When the branches are bisected longitudinally (Fig. 80), it is found that the terminal openings (*o*) lead into narrow passages, wide enough to admit a stout pin, running through the axes of the

cylinders; and the passages in the interior of the various branches join where the branches join—the passages thus forming a communicating system. On the wall of the passages are numerous fine apertures which require a strong lens for their detection. The larger apertures at the ends of the branches are the *oscula* of the sponge, the passages the *paragastric cavities*. If a living *Sycon* is placed in sea-water with which has been mixed some carmine powder, it will be noticed that the minute particles of the carmine seem to be attracted towards the surface of the sponge, and will often be seen to pass into its substance through the minute inhalant pores or *ostia* already mentioned as occurring in groups between the elevations on

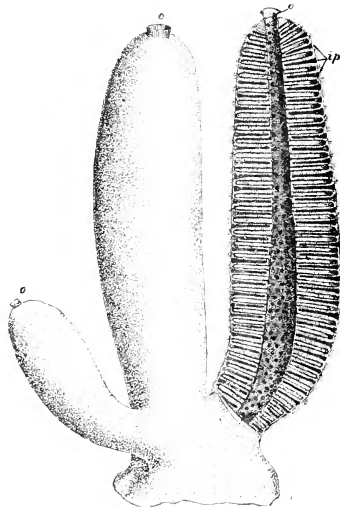

FIG. 80.—*Sycon gelatinosum*. A portion slightly magnified; one cylinder (that to the right) bisected longitudinally to show the central paragastric cavity opening on the exterior by the osculum, and the position of the incurrent and radial canals; the former indicated by the black bands, the latter, dotted; *ip.* marks the position of three of the groups of inhalant pores at the outer ends of the incurrent canals; *o.* osculum.

the outer surface. This would appear to be due to the passage of a current of water into the interior of the sponge through these minute openings dotted over the surface: and the movement of the floating particles shows that a current is at the same time flowing out of each of the oscula. A constant circulation of water would thus be seen to be carried on—currents moved by some invisible agency flowing through the walls of the sponge to the central paragastric cavities, and passing out again by the oscula.

If a portion of the *Sycon* is firmly squeezed, there will be pressed out at first sea-water, and then, when greater pressure is exerted, a quantity of gelatinous-looking matter, which, on being

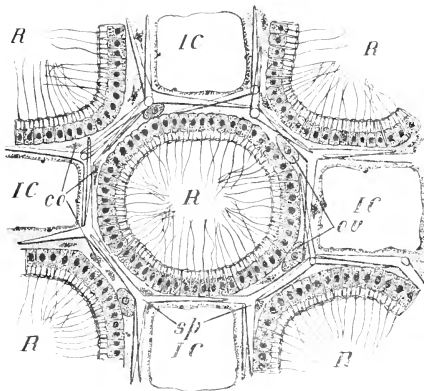

FIG. 81.—*Sycon gelatinosum*. Section through the wall of a cylinder taken at right angles to the long axes of the canals, highly magnified; *co*, collenocytes; *IC*, incurrent canals; *ov*, young ova; *R*, radial canals; *sp*, triradiate spicules.

examined microscopically, proves to be partly composed of a protoplasmic material consisting of innumerable usually more or less broken cells with their nuclei, and partly of a non-protoplasmic, jelly-like substance. When this is all removed there remains behind a toughish felt-like material, which maintains more or less completely the original

shape of the sponge. This is the *skeleton* or supporting framework. A drop of acid causes it to dissolve with effervescence, showing that it consists of carbonate of lime. When some of it is teased out and examined under the microscope, it proves to consist of innumerable, slender, mostly three-rayed microscopic bodies (Figs. 81 and 82, *sp*) of a clear glassy appearance. These are the *calcareous spicules* which form the skeleton of the *Sycon*.

The arrangement of the spicules, their relation to the protoplasmic parts, and the structure of the latter, have to be studied in thin sections of hardened specimens (Figs. 81 and 82). An examination of such sections leads to the following results.

Microscopic Structure.—Covering the outer surface of the sponge is a single layer of cells—the *dermal layer* or

*ectoderm*¹ (Fig. 82, *ec*)—through which project regularly-arranged groups of needle-like and spear-like spicules (*sp'*), forming the pattern of polygonal elevations on the outer surface. The cells of the ectoderm (*pinacocytes*) are in the form of thin scales, which are closely cemented together by their edges. The paragastric cavities are lined by a layer of cells (*en*) which are, like those of the ectoderm, thin flattened scales. Running radially through the thick wall of the cylinders are a large number of regularly-arranged straight passages. Of these there are two sets, those of the one set—the *incurrent canals* (Figs. 81 and 82, *IC*)—narrower, and lined by ectoderm similar to the ectoderm of the surface; those of the other set—the *radial or flagellate canals* (*R*)—rather wider, octagonal in cross-section, and lined by *endoderm* continuous with the lining of the paragastric cavity. The incurrent canals end blindly at their inner extremities—not reaching the paragastric cavity; externally each becomes somewhat dilated, and

¹ The terms *ectoderm* and *endoderm* are here used as convenient terms for the outer and inner layers of the Sponge, though, as will appear later, these layers differ completely in their mode of formation from the layers so named in the higher phyla.

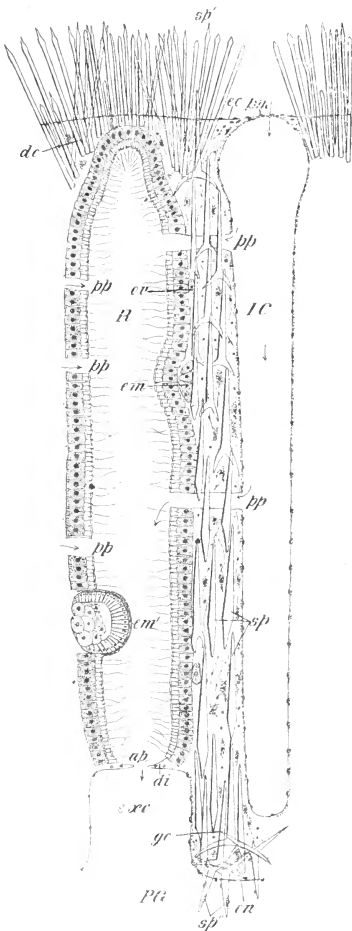

FIG. 82.—*Sycon gelatinosum*. Transverse section through the wall of a cylinder (parallel with the course of the canals), showing one incurrent (*IC*), and one radial (*R*) canal throughout their length; *sp*, tri- and tetraradiate spicules; *sp'*, oxeate spicules of dermal cortex (*dc*); *sp''*, tetraradiate spicules of gastral cortex (*gc*); *ec*, ectoderm; *en*, layer of flattened cells lining the paragastric cavity; *pm*, pore-membrane; *pp*, prosopyles; *ap*, apopyle; *di*, diaphragm; *exc*, excurrent passage; *P.G.*, paragastric cavity; *cm*, early embryo; *em'*, late embryo. The arrows indicate the course of the water through the sponge.

the dilatations of neighbouring canals often communicate. These dilated parts are closed externally by a thin membrane—the *pore-membrane* (Fig. 82, *pm*, and Fig. 83), perforated by three or four small openings (Fig. 83, *p*)—the ostia already referred to. The flagellate canals are blind at their outer ends, which lie at a little distance below the surface opposite the polygonal projections referred to above as forming a pattern on the outer surface; internally, each communicates with the paragastric cavity by a short, wide passage—the *excurrent canal* (Fig. 82, *exc.*) Incurrent and flagellate canals run side by side, separated by a thin layer of sponge substance except at certain points, where there exist small apertures of communication—the *prosopyles* (*pp*)—uniting the cavities of adjacent incurrent and flagellate canals. Each prosopyle is a perforation in a single cell termed a *porocyte*.

The ectoderm lining the incurrent canals is of the same character as that of the outer surface. The endoderm of the

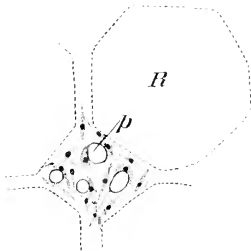

FIG. 83.—*Sycon gelatinosum*. Surface view of a pore-membrane highly magnified; *p*, ostium; *R*, position of the outer end of a radial canal.

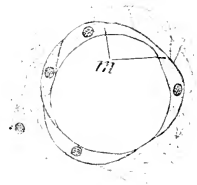

FIG. 84.—*Sycon gelatinosum*. An apopyle surrounded by its diaphragm; *m*, contractile cells.

flagellate canals, on the other hand, is totally different from that which lines the paragastric cavity. It consists of cells of columnar shape ranged closely together so as to form a continuous layer. Each of these *flagellate endoderm cells*, or *collared cells*, or *choanocytes*, as they are termed, is not unlike one of the Choanoflagellate Protozoa (p. 79); it has a nucleus, one or more vacuoles, and, at the inner end, a single, long, whip-like flagellum, surrounded at its base by a delicate, transparent, collar-like upgrowth, similar to that which has already been described as occurring in the Choanoflagellata. If a portion of a living specimen of the sponge is teased out in sea-water, and the broken fragments are examined under a tolerably high power of the microscope, groups of these collared cells will be detected here and there, and in many places the movement of the flagella will be readily observed. The flagellum is flexible but with a certain degree of stiffness,

especially towards the base, and its movements resemble those which a very supple fishing-rod is made to undergo in the act of casting a long line—the movement being much swifter and stronger in the one direction than in the other. The direction of the stronger movement is seen, when some of the cells are observed in their natural relations, to be from without inwards. It is to these movements that the formation of the currents of water passing along the canals is due. The collars of the cells in specimens teased in this way become for the most part drawn back into the protoplasm.

The short passage or excurrent canal, which leads inwards from the flagellate canal to the paragastric cavity, differs from the former in being lined by flattened cells similar to those of the paragastric cavity; it is partly separated from the flagellate canal by a thin diaphragm (Fig. 82, *d_i*, and Fig. 84), perforated by a large circular central aperture—the *apopyle* (*ap*)—which is capable of being contracted or dilated: its opposite aperture of communication with the paragastric cavity, which is very wide, is termed the *gastric ostium* of the excurrent canal.

The effect of the movement of the flagella of the cells in the flagellate canals is to produce currents of water running from without inwards along the canals to the paragastric cavity. This causes water to be drawn inwards through the prosopyles from the incurrent canals, and, indirectly, from the exterior through the perforated membranes at the outer ends of the latter.

Between the ectoderm of the outer surface and of the incurrent canals, and the endoderm of the inner surface and of the flagellate canals, are a number of spaces filled by an intermediate layer—the *mesoglaea*—in which the spicules of the skeleton are embedded. Each spicule is developed from cells termed *scleroblasts*, which migrate inwards from the ectoderm. Each ray is formed by the agency of a separate scleroblast, so that there are three at least of the latter for each triradiate, and four for each tetraradiate spicule. The spicules (Figs. 81 and 82, *sp*) are regularly arranged, and connected together in such a way as to protect and support the soft parts of the sponge. Most are, as already noticed, of triradiate form. Large numbers, however, are of simple spear-like or club-like shape (*sp'*); these, which are termed the *oxeote spicules*, project on the outer surface beyond the ectoderm, and are arranged in dense masses, one opposite the outer end of each of the flagellate canals, this arrangement producing the pattern already referred to as distinguishable on the outer surface. The thick outer layer in which the bases of these oxeote spicules lie embedded is termed the *dermal cortex* (*dc*). A thick stratum at the inner ends of the canals and immediately surrounding the paragastric cavity is termed the *gastral cortex* (*gc*). It is supported by triradiate and also by tetraradiate spicules, one ray

of each of which (*sp*"') frequently projects freely into the paragastric cavity, covered over by a thin layer of flattened endoderm cells.

The mesogloea itself, as distinguished from the spicules which lie embedded in it, consists of a clear gelatinous substance containing numerous nucleated cells of several different kinds. Most of these are small cells of stellate shape, with radiating processes—the *connective-tissue cells* or *collencytes* (Fig. 81, *co*); others are fusiform; a good many—the amœboid *wandering cells*—are Amœba-like, and capable of moving about from one part of the sponge to another.

Around the inhalant pores and the apopyles are elongated cells (Figs. 83 and 84), sometimes prolonged into narrow fibres. These are contractile—effecting the closure of the apertures in question—and are therefore to be looked upon as of the nature of *muscular fibres*. In the case of the inhalant pores they are ectodermal; in that of the apopyles they are endodermal. A band of similar fibres surrounds the osculum—the *oscular sphincter*.

The sexual reproductive cells—the ova (Figs. 81 and 82, *ov*) and sperms—are developed immediately below the flagellate endoderm cells of the flagellate canals, and in the same situation are to be found developing embryos (*em*, *em'*), resembling in their various stages those of *Sycon raphanus*, as described below.

2.—DISTINCTIVE CHARACTERS AND CLASSIFICATION.

Sponges are plant-like, fixed, aquatic Metazoa, all, with the exception of one family, inhabitants of the sea. The primary form is that of a vase or cylinder, the sides of which are perforated by a number of pores and in the interior of which is a single cavity; but in the majority of Sponges a process of branching and folding leads to the formation of a structure of a much more complex character. The surface of the Sponge is covered by a single layer of flattened cells—the *ectoderm*¹—and the internal cavities, or a part of them, are lined by a second single layer—the *endoderm*—part or the whole of which consists of a single layer of *choanocytes*, *i.e.* columnar collared cells, each provided internally with a long flagellum. Between these two layers is a quantity of tissue usually of a gelatinous consistency—the *mesogloea*—containing a number of cells of various kinds. The wall of the Sponge is pierced by a number of apertures. The skeleton or supporting framework, developed in the mesogloea from cells derived from the ectoderm, consists in some cases of fine, flexible fibres of a material termed *spongin*; in others of spongin-fibres supplemented by microscopic siliceous spicules; in others of siliceous spicules alone; in others of spicules of carbonate of lime. Reproduction takes place both asexually by the formation of *gemmules*, and

¹ See footnote on p. 109.

sexually by means of ova and sperms. The ovum develops into a ciliated free-swimming larva, which afterwards becomes fixed and develops into the plant-like adult Sponge.

The Sponges are sufficiently far removed in structure from the rest of the Metazoa to justify us in looking upon them as constituting one of the great divisions or phyla of the animal kingdom. At the same time there is so much uniformity of structure within the group that a division into classes is not demanded; the phylum Porifera contains a single class.

The class Porifera is classified as follows:—

Sub-Class I.—Calcarea.

Sponges with a skeleton of calcareous spicules, and with comparatively large collared cells.

ORDER 1.—HOMOCCELA.

Calcareous Sponges in which the internal lining membrane consists throughout of flagellate collared cells.

ORDER 2.—HETEROCCELA.

Calcareous Sponges in which the paragastric cavity is lined by flattened cells, the collared cells being restricted to flagellate canals or chambers.

Sub-Class II.—Hexactinellida.

Sponges with six-rayed, tri-axon, siliceous spicules, and simple canal system represented by unbranched or branched flagellate chambers.

Sub-Class III.—Demospongia.

Sponges either devoid of skeleton or with spongin fibres alone, or a combination of spongin fibres and siliceous spicules, the latter, when present, never six-rayed; the canal system of the Rhagon type (p. 119), usually complicated.

ORDER 1.—TETRACTINELLIDA.

Demospongia with tetraxon spicules.

ORDER 2.—MONAXONIDA.

Demospongia with monaxon spicules.

ORDER 3.—CERATOSA.

Demospongia with skeleton of spongin fibres without siliceous spicules.

ORDER 4.—MYXOSPONGIA.

Demospongia devoid of skeleton.

Systematic Position of the Example.

Sycon gelatinosum is one of many species of the genus *Sycon*. *Sycon* is one of several genera of the family *Sycettidæ*; and the family *Sycettidæ* is one of several families of the order *Heterocœla* of the class *Calcarea*. Among the families of the *Heterocœla*, that of the *Sycettidæ* is distinguished by the following features, which characterise all its members:—

“The flagellate chambers are elongated, arranged radially around a central paragastric cavity, their distal ends projecting more or less on the dermal surface, and not covered over by a continuous cortex. The skeleton is radially symmetrical.”

Of the genera into which the *Sycettidæ* are divided, *Sycon* is characterised as follows:—

“The flagellate chambers are not intercommunicating; their distal ends are provided each with a tuft of oxete spicules.”

The members of one of the other genera of the family—*Sycetta*—while possessing the general characteristics of the family, differ from those of the genus *Sycon* in wanting the tufts of oxete spicules; those of a third—*Sycantha*—have the flagellate chambers united in groups; the chambers of each group intercommunicating by openings in their walls, and each group having a single common opening into the gastric cavity. The members of this genus resemble *Sycon*, and differ from *Sycetta*, in the presence of tufts of oxete spicules at the distal ends of the flagellate chambers.

These distinctions between classes, orders, families, and genera are of an entirely arbitrary character. No such divisions exist in nature; and they are merely established as a convenient way of grouping the sponges and facilitating their classification. But a classification of this kind, if carried out on sound principles, should nevertheless have something corresponding to it in nature, inasmuch as the grouping of the various divisions and subdivisions aims at expressing the relationships of their members to one another. The members, for example, of the family *Sycettidæ* are all regarded, on account of the features which they possess in common, as being more nearly related to one another than to the members of the other families, and as having been derived from a common ancestor which also possessed those features—the divergences of structure which we observe in the different genera and species being the result of a gradual process of change.

Within the limits of the genus *Sycon*, *S. gelatinosum* is distinguished from the rest as a group of individual Sponges all possessing certain *specific* characters which it will be unnecessary to detail here. But the individual Sponges referable to this species frequently differ somewhat widely from one another: there are numerous *individual variations*. If we compare a number of specimens all possessing the species-characters of *Sycon gelatino-*

sum, we find that they differ in the number of branches, in the shape of the cylinders,—some being relatively narrow, some relatively wide—in the degree of development of the oscular crown of spicules, in the ratio of the thickness of the wall to the width of the contained paragastric cavities, and in many other more minute points; in fact, we find as a result of the comparison that no two specimens are exactly alike. These differences are so great that some very distinct races or *varieties* of *S. gelatinosum* have been recognised, and some have received special names. Here again, as in the case of the families and orders, the distinctions are of an arbitrary character—some writers on Sponges setting down as several species what others regard merely as varieties of one species. It is impossible, in fact, to draw a hard and fast line of distinction between species and varieties. In the higher groups of animals the attempt is made to establish a *physiological* distinction; all the members of a species are regarded as being fertile *inter se*, and capable of producing fertile offspring as a result of their union; but such a mode of distinguishing species is impossible of application among lower forms such as the sponges. In these lower groups, accordingly, a species can only be defined as an assemblage of individuals which so closely resemble one another that they might be supposed to be the offspring of a parent-form similar to themselves in all the most essential features. And, according to the view taken of the relative importance of different points of colour, shape, and internal structure, the conceptions of the species and their varieties and mutual relationships formed by different observers must often differ widely from one another.

3. GENERAL ORGANISATION.

General Form and Mode of Growth.—The simplest Sponges are vase-shaped or cylindrical in form, either branched or unbranched; and, if branched, with or without anastomosis or coalescence between neighbouring branches. But the general form of the less simple Sponges diverges widely from that of such a branching cylinder as is presented by *Sycon gelatinosum* (Fig. 79).

From the point to which the embryonic sponge becomes attached it may spread out horizontally, following the irregularities of the surface on which it grows, and forming a more or less closely adherent encrustation like that of an encrusting lichen (Fig. 85, 4). The surface of such an encrustation may be smooth; more commonly it is raised up into elevations—rounded bosses, cones, ridges or lamellæ; and the edges may be entire or lobed. In other cases the sponge grows at first more actively in the vertical than in the horizontal direction, and the result may be a long, narrow structure, cylindrical or compressed, and more or less

branched (Fig. 85, *B*). Sometimes vertical and horizontal growth is almost equal, so that eventually there is formed a thick, solid mass of a rounded or polyhedral shape (Fig. 85, *C*), with an even, or lobed, or ridged surface. Very often, after active vertical growth has resulted in the formation of a comparatively narrow basal part or stalk, the Sponge expands distally, growing out into lobes or branches of a variety of different forms, and frequently anasto-

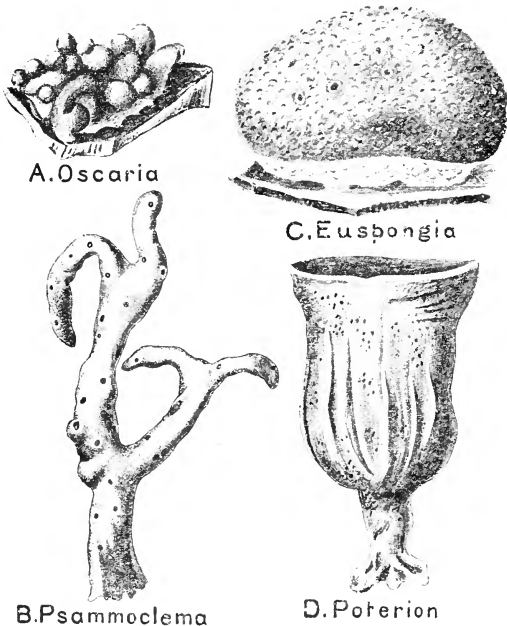

FIG. 85.—External form of various Sponges. A, *Oscaria*, an encrusting form, with the upper surface raised up into a number of rounded prominences; B, *Psammoclema*, a ramifying subcylindrical Sponge; C, *Euspongia* (toilet sponge), a massive form with a broad base; D, *Poterion* (Neptune's Cup), an example of a complex Sponge assuming the form of a vase. (After Vosmaer.)

mosing. Sometimes, after the formation of the stalk with root-like processes for attachment, the Sponge grows upwards in such a way as to form a cup or tube with a terminal opening. Such a cup-shaped Sponge, exemplified in the gigantic Neptune's Cup (*Poterion*, Fig. 85, *D*), is not to be confounded with the simple vase or cup referred to above as the simplest type of Sponge, being a much more complex structure with many oscula. Some-

times the Sponge grows from the narrow base of attachment into a thin flat plate or lamella; this may become divided up into a number of parts or lobes, which may exhibit a divergent arrangement like the ribs of an open fan. Often the lamella becomes folded, and sometimes there is a coalescence between the folds, resulting in the development of a honey comb-like form of sponge.

Sponges resemble plants, and differ from the higher groups of animals, in the readiness with which, in many cases, their form becomes modified during growth by external conditions (environment). Different individuals of the same kind of Sponge, while still exhibiting the same essential structure and the same general mode of growth, may present a variety of minor differences of form, in accordance with differences in the form of the supporting surface or in the action of waves and currents.

Leading Modifications of Structure.—*Sycon gelatinosum* belongs to a type of Sponges intermediate between the very simplest forms on the one hand and the more complex on the other. The simplest type of Sponge-structure is that of the so-called *Ascetta* or *Olynthus* (Fig. 86). This is not a mature form—no adult Sponge retaining such simplicity of structure. It is vase-shaped, contracted at the base to form a sort of stalk by the expanded extremity of which it is attached; at the opposite or free end is the circular osculum. So far there is a considerable resemblance to *Sycon gelatinosum*; but the structure of its wall in *Ascetta* is extremely simple. Regularly

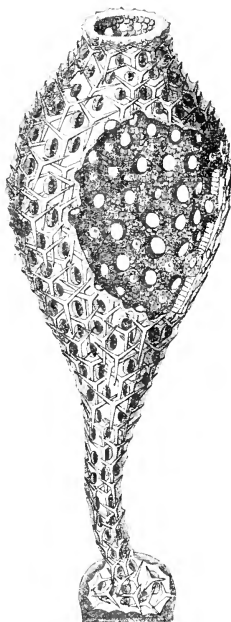

FIG. 86.—*Olynthus* stage of a simple calcareous Sponge (*Clathrina*). A portion of the wall of the vase-like sponge removed to show the paragastric cavity. (After Haeckel.)

arranged over the surface are a number of small rounded apertures, the inhalant pores; but, since the wall of the Sponge is very thin, these apertures lead directly into the central or paragastric cavity (Fig. 87, A), the long passages or canals through which the communication is effected in *Sycon* being absent. The wall consists of the same three layers as in *Sycon*, but the middle one, though it contains a small number of spicules, is very thin. The ectoderm is a thin layer of flat cells; the paragastric cavity is lined throughout by choanocytes similar to those of the flagellate canals of *Sycon*.

A somewhat more complex type of structure than that of *Ascetta*

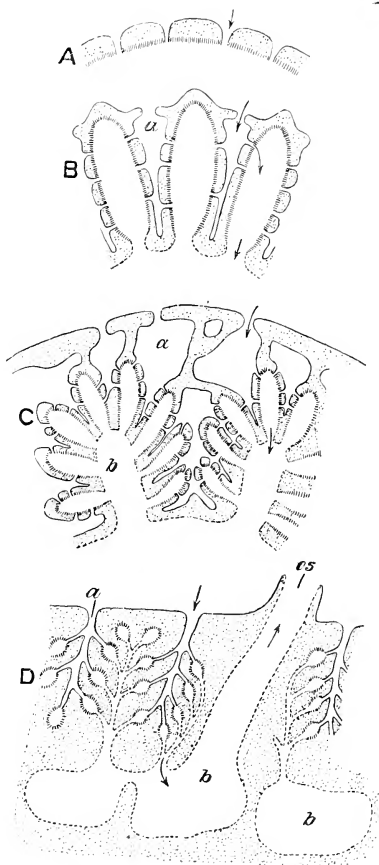

FIG. 87.—Diagram of the canal system of various sponges, the ectoderm denoted by a continuous narrow line; the flattened endoderm by an interrupted line; the flagellate endoderm by short parallel strokes. *A*, cross-section through a part of the wall of an *Ascon*; *B*, cross-section through a part of the wall of a *Sycon*; *C*, cross-section through a part of the wall of *Oscarella convexa*; *D*, vertical section through *Oscarella*; *a*, spaces of the incurrent canal system; *b*, spaces of the excurrent canal system; *os*, osculum. (After Korschelt and Heider.)

is exhibited by those sponges in which the wall becomes thickened and perforated by radially-arranged canals, which open directly on the outer surface by means of *inhalant pores* or *ostia*, and lead directly into the paragastric cavity by means of *apopyles*—the whole inner surface as well as the radial canals being lined with flagellate endoderm cells. In forms which may be regarded as representing the next stage of development (Fig. 87, *B*: see also the figures of *Sycon gelatinosum*), there are formed by infolding of the surface, in the intervals between the radial canals, canal-like spaces, the *incurrent canals*, lined by ectoderm and communicating with the exterior on the one hand, either by a wide opening or by pores (*ostia*) perforating a pore-membrane, and on the other by means of small openings, the *prosopyles* (the equivalents of the inhalant pores of the *Olynthus*), with the radial canals. Sponges similar to *Sycon gelatinosum*, but with

flagellate canals arranged in groups, each group centred round a main excurrent canal (Fig. 87, *C*), afford us the next grade of advancing complexity. In these the incurrent canals may form a branching system. In all the higher groups of Sponges (Fig. 87, *D*, and Fig. 88) the flagellate cells are confined to certain special enlargements of the canals—the so-called “ciliated chambers” (*C*)—and the rest of the canals are lined by flattened cells.

Special names have been applied to the main types of canal-system briefly sketched above. Forms in which the paragastric cavity is lined by flagellate cells are said to belong to the *Ascon* type, whether the paragastric cavity communicates directly or by flagellate canals with the exterior. Forms in which there is a paragastric cavity lined by flattened cells, and a system of radially arranged flagellate chambers, are said to possess the *Sycon* type of structure. Such Sponges as have small rounded flagellate cham-

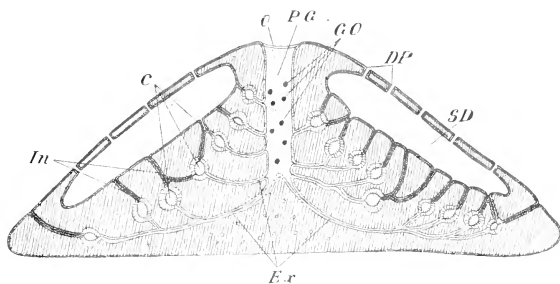

FIG. 88.—Vertical section of a fresh-water sponge (*Spongilla*), showing the arrangement of the canal-system. *C*, ciliated chambers; *DP*, dermal pores; *Er*, excurrent canals; *GO*, openings of the excurrent canals; *PG*, paragastric cavity; *SD*, subdermal cavities; *O*, osculum. (Modified from Leuckart and Nitsche's diagrams.)

bers (“ciliated chambers”), communicating in most cases by narrow branching incurrent canals with the exterior (directly or indirectly) on the one hand, and by similar excurrent canals with the paragastric cavity on the other—the flagellate cells being confined to the flagellate chambers—are said to possess the *Rhagon* type of canal-system. In the *Rhagon* proper the arrangement of parts is very simple. The Sponge has a paragastric cavity opening on the exterior by an osculum. Opening into this central cavity by wide apopyles are a number of rounded chambers, each communicating with the exterior by an inhalant pore (prosopyle).

A thicker or thinner specialised outer layer—the *dermal cortex*—situated immediately below the superficial ectoderm, is present in many Sponges. This is a layer of mesogloea with special skeletal elements, usually containing spaces and canals lined by ectoderm—(*subdermal cavities*, Fig. 88, *SD*)—which communicate

directly with the exterior, and, internally, usually with more deeply situated spaces (*subcortical cavities*), from which the incurrent canals lead to the ciliated chambers. This dermal cortex is present, though not highly developed, in *Sycon gelatinosum* (Fig. 82, *dc*), and the enlarged outer ends of the incurrent canals lying in the dermal cortex and closed externally by the pore-bearing membrane may be regarded as representing dermal cavities. In most higher sponges a special inner layer is developed;

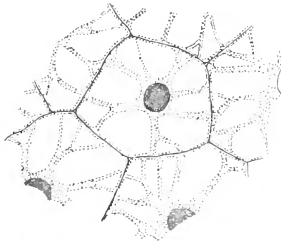

FIG. 89.—Cells of the ectoderm (*pinacocytes*) very highly magnified. (After Von Lendenfeld.)

this is the *gastral cortex*, represented in a rudimentary form in *Sycon gelatinosum* (Fig. 82, *gc*) as the internal layer with special spicules, in which the excurrent canals are situated.

Histology.—In the protoplasmic elements or cells of the various groups of Sponges there is little variation, except in minor points. The cells (*pinacocytes*) of the ectoderm (Fig. 89) are flattened, and very rarely assume other forms; in some cases each flattened ectodermal cell is provided with a flagellum. Lining the paragastric cavities and canals is a layer of flattened cells similar to those of the ectoderm, or of flagellate collared cells. In the gelatinous substance of the mesogloea are embedded connective-tissue cells, amœboid wandering cells, and, in certain positions (around orifices), muscle-cells. Unicellular glands (see p. 26) are present in some sponges, both calcareous and siliceous; also cells containing the pigment to which the bright colour of many sponges is due, though in most cases the pigment is not confined to special cells, but occurs scattered through the connective-tissue cells and flagellate cells. Fresh-water Sponges are often green, owing to the presence of chlorophyll, the colouring matter to which the prevailing green colour of plants is due.

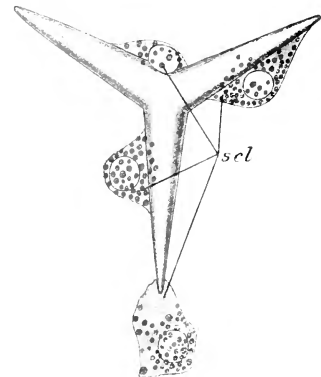

FIG. 90.—Development of a tri-radiate spicule of *Clathrina*. *scl*, scleroblasts. (After Murchin.)

The elements of the skeleton differ in character in the different

classes. In the *Calcarea* they consist of calcareous spicules, usually tri-radiate in form. Each of these spicules is developed from special cells—the *scleroblasts* (Fig. 90). In the remaining groups of Sponges the skeleton either consists of spongin fibres alone (Fig. 91, *A*), or of siliceous spicules alone, or of a combination of spongin fibres with siliceous spicules (*B*): in some *Demospongia* (the *Myxospongia*)

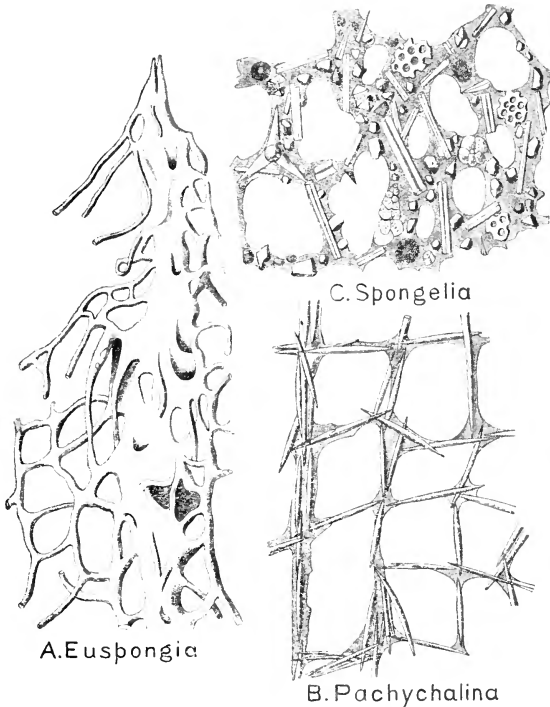

FIG. 91.—Microscopic structure of the skeleton in various sponges. *A*, *Euspongia*, network of spongin fibres; *B*, *Pachychalina*, spongin strengthened by various foreign siliceous bodies, fragments of spicules of other sponges, &c. (After Vosmaer.)

skeletal parts are altogether absent. Spongin is a substance allied to silk in chemical composition and contains a large amount of iodine: the fibres are exceedingly fine threads, consisting of a soft granular core and an outer tube of concentric layers of spongin. These threads branch and anastomose, or are woven and felted

together in such a way as to form a firm, elastic, supporting structure. They are secreted by the activity of certain cells in the mesogloea which are called the *sponginblasts*, derived from the ectoderm. In certain exceptional cases the spongin assumes the form of spicules. The siliceous spicules (Fig. 92) are much more varied in shape than the spicules of the *Calcarea*, and in a single kind of Sponge there may be a number of widely differing forms of spicules, each form having its special place in the skeleton of the various parts of the Sponge-body. In most forms siliceous spicules and spongin fibres combine to form the supporting framework, the relative development of these two elements varying greatly in different cases. But in certain groups, including the common washing-sponges (Fig. 91, *A*), spicules are completely absent, and the entire skeleton consists of spongin. In some forms which are devoid of spicules, the place of these is taken by foreign bodies—shells of *Radiolaria*, grains of sand, or spicules from other sponges (Fig. 91, *C*). In others, again, such as the Venus's Flower-Basket (*Euplectella*), the Glass-Rope Sponge (*Hyalonema*), and *Pheronema* (Fig. 93), the skeleton consists throughout of siliceous spicules bound together by a siliceous cement.

Reproduction in the Sponges is effected either sexually or asexually. In some cases asexual multiplication takes place by the production of external buds; in others of internal buds in the shape of groups of cells called *gemmules*, which eventually become detached and develop into new individuals. In the Fresh-water Sponges (*Spongillida*) multiplication takes place very actively by means of such gemmules, each of which is a spherical group of cells enclosed in an envelope often with peculiarly-shaped siliceous spicules, termed *amphidiscs* (Fig. 92, right side). These gemmules are formed in the substance of the Sponge towards the end of the year; they are set free by the decay of the part of the parent sponge in which they are developed, and fall to the bottom. In spring the contained mass of protoplasmic matter reaches the exterior through an aperture in the wall of the gemmule, and develops into the adult form.

All Sponges multiply by a sexual process—by means of male cells, or *sperms*, and female cells, or *ova*.¹ These are developed from certain of the amœboid wandering cells of the mesogloea, which take up a special position, usually immediately below the collared cells of the endoderm. Ova and sperms are developed in the same Sponge, but rarely at the same time. The amœboid cell destined to form sperms divides into a number of small cells, giving rise to a rounded mass of sperms. The latter, when mature, have an oval or pear-shaped head and a long tapering appendage or tail. Each amœboid cell destined to form an ovum enlarges, and

¹ Sexually-produced larvae have not hitherto been found in the Hexactinellida or Tetractinellida.

eventually assumes a spherical form. After a sperm has penetrated into its interior and effected impregnation, the ovum usually becomes enclosed in a brood-capsule formed for it by certain neighbouring cells, and in this situation, still enclosed in the parent Sponge, it undergoes the earlier stages of its development. The boring Sponge, *Cliona*, is the only one, so far as known, in which the early stages of development are passed through externally.

In all known cases there is a free-swimming ciliated larval stage; but the form assumed by the larva differs profoundly in different Sponges. Of the simpler types of calcareous sponges with a structure resembling that of the *Olythus*, the development has been followed out in the case of *Clathrina blanca*. In this sponge segmentation is followed by the formation of an oval blastula, the wall of which consists of a single layer of cells all alike in kind—elongated, columnar, and flagellate. At one pole of the blastula is seen a pair of cells which are of a different character, being large, rounded, and granular. These are destined to give rise to the *archæocytes*, some of which form the reproductive cells. Certain of the flagellate cells then withdraw their flagella and pass into the internal cavity, becoming amœboid. Soon a large number of these amœboid cells come to fill up a great part of the

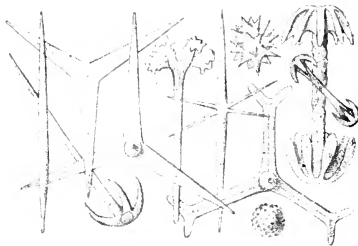

FIG. 92.—Various forms of sponge spicules.
(From Lang's *Text-Book*.)

cavity of the larva, which now passes into a stage corresponding to the *planula* larva of the Cœlenterates (Section IV). This is the larval form known as the *parenchymula*. The *parenchymula* (Fig. 94) consists of three kinds of cells:—(1) an external layer of flagellate cells; (2) an inner mass of amœboid cells; (3) the two posterior granular cells. In this condition it becomes fixed, and develops into the form of a flat plate with an irregular outline. Most of the amœboid cells now migrate to the outer surface, passing between the flagellate cells and then becoming arranged outside them to form the ectoderm. The flagellate cells now form an irregular mass together with a number of non-flagellate cells derived from the ectoderm, which are destined to give rise to the porocytes. A cavity appears in the mass, and becomes surrounded by a layer of porocytes. The cavity increases in size, and is soon seen to be bounded not by the porocytes alone, but in part also by flagellate cells. Subsequently the flagellate cells come to form the entire boundary of the cavity, the porocytes passing outwards to become

perforated by apertures—the inhalant apertures—in the wall of the sponge. Among the flagellate cells and porocytes there are also amœboid cells derived from the two original granular cells;

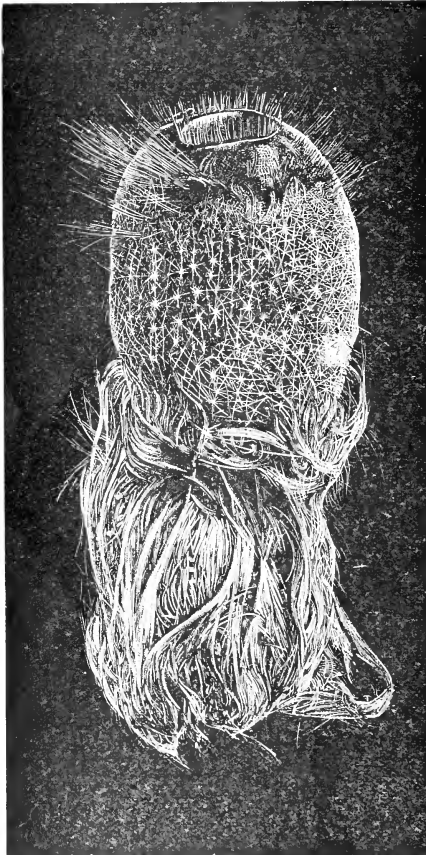

FIG. 93.—*Pheronema carpenteri*, one of the Hexactinellida.
(From Wyville Thomson.)

some of these give rise to the reproductive cells. The scleroblasts are formed of certain ectoderm cells which migrate inwards, and at an early stage arrange themselves in threes to give rise to the tri-radiate spicules. The development of the sponge becomes completed by the enlargement of the internal cavity (paragastric cavity) which is now lined by flagellate cells, and by the development of the osculum.

In *Sycon* the early stages (Fig. 95, a-e) differ somewhat from those in *Clathrina blanca*, and the embryo leaves the parent sponge in the peculiar stage to which the name of *amphiblastula* is applied. When the blastula is

formed the greater part of its wall consists of clear cells, with a number of granular cells—the archæocytes—at the posterior pole.

The clear cells become elongated and flagellate. The archæocytes pass into the internal (segmentation) cavity and become completely enclosed by the flagellate cells (stage of so-called *pseudogastrula*).

The cells at the posterior end then lose their flagella and become large rounded granular cells, so that after a time the wall of the embryo comes to be composed in one half of the flagellate cells that have remained unaltered, and in the other half of the larger granular cells. It is in this stage—termed the *amphiblastula* (Fig. 95, e)—that the larval sponge becomes free. At a later stage the flagellate cells are partly overgrown by the granular cells, the latter eventually giving rise to the ectoderm of the adult, while the former become the flagellate collared cells. The larva fixes itself by one side, and soon assumes a cylindrical form (*h, i*). An aperture which is developed at the free end becomes the osculum, and small perforations in the sides of the cylinder form the inhalant apertures. As the wall of the cylinder increases in thickness by the growth of the mesogloea, the radial canals are formed, the endoderm extending into them, its cells remaining flagellate to form the choanocytes of the radial canals.

The *amphiblastula* type of larva is characteristic of the Calcarea, and is probably universal in that sub-class except in such primitive forms as *Clathrina*.

In the Silicispongia, on the other hand, the typical larva is a solid body with a superficial layer of flagellate cells, and an internal mass of granular cells. From the former, apparently, the collared cells of the flagellate chambers are formed: from the latter the external ectoderm and the other elements of the body of the Sponge. The granular cells break through the flagellate cells at one end and grow over the latter as an investing layer. This is a remarkable reversal of what, as will be seen subsequently, is to be observed in the Cœlenterata—and in fact in the rest of the Metazoa, but is readily reconcilable with what takes place in Sycon and the more complex Calcarea.

Distribution and Mode of Occurrence of Sponges and their Position in the Animal Series.—Fossil remains of Sponges have been found in various formations from those of the Cambrian period onwards, the greatest abundance being found in the Chalk. No extinct class or order has been detected, the fossil forms all

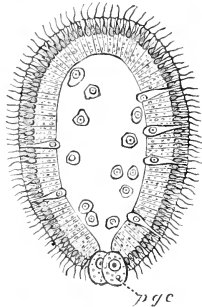

FIG. 94.—Median longitudinal section of the parenchymula larva of *Clathrina blanca*. p.g.c., posterior granular cells which give rise to the archæocytes. (From the Cambridge Natural History, after Minchin.)

being members of existing groups.¹ Some of the orders of existing Sponges—such as the Myxospongiæ—are incapable of being preserved as fossils, and the fossil forms belong, as we should expect, to the more highly silicified groups and to the more complex groups of the Calcarea.

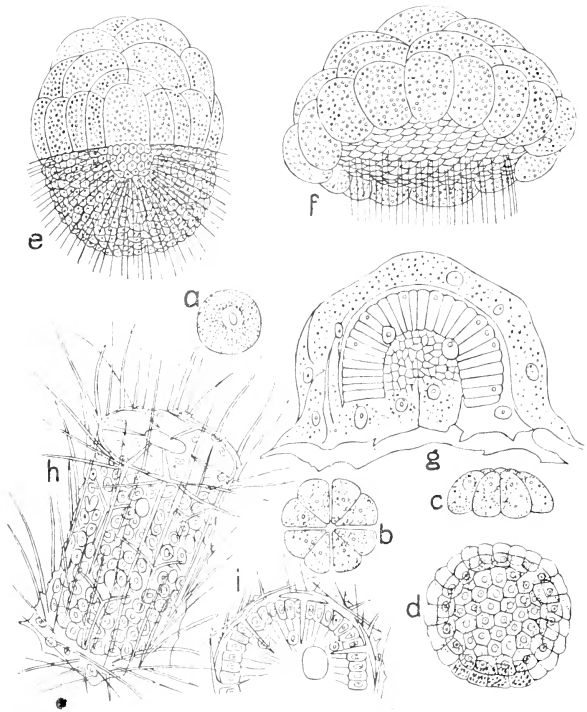

FIG. 95.—Development of *Sycon raphanus*. *a*, ovum; *b, c*, ovum segmented—*b* as seen from above, *c*, lateral view; *d*, blastula; *e*, amphiblastula; *f*, commencement of invagination; *g*, larva attached by its oral face; *h, i*, young sponge—*h*, lateral view; *i*, as seen from above. (From Sollas, after Schulze.)

Fresh-water Sponges (*Spongillida*) occur in rivers, canals, and lakes in all the great divisions of the earth's surface. Marine Sponges occur in all seas, and at all depths, from the shore

¹ The *Archæogastrea*, reef forming organisms of Cambrian age, may have been nearly related to the Calcareous Sponges; but this remains doubtful.

between tide-marks to the deepest abysses of the ocean. The Calcareous and the true horny sponges (*Ceratosa*) are most abundant in shallow water, and have not been found below 450 fathoms. The Sponges found at the greatest depths are members of the groups *Hexactinellida* and *Choristida*.

Sponges do not appear to be edible by Fishes or even the higher Crustaceans or Molluscs. Countless lower animal forms, however, burrow in their substance, if not for food, at least for shelter, and the interior of a Sponge is frequently found to be teeming with small Crustaceans, Annelids, Molluscs, and other Invertebrates. None of the Sponges are true parasites. The little Boring Sponge, *Cliona*, burrows in the shells of Oysters and other bivalves, but for protection and not for food. But a Sponge frequently lives in that close association with another animal or plant to which the term *messmateism*, or *commensalism*, is applied, associations which benefit one or both. Thus some species of Sponge are never found growing except on the backs or legs of certain Crabs. In these cases the Sponge protects the Crab and conceals it from its enemies, while the Sponge benefits by being carried from place to place and thus obtaining freer oxygenation. Certain Cirripede Crustaceans (members of the order to which the Barnacles and Acorn-shells belong) are invariably found embedded in certain species of Sponge. Frequently a Sponge and a Zoophyte grow in intimate association, so that they seem almost to form one structure. Thus the Glass-rope Sponge (*Hyalonema*) is always found associated with a Zoophyte (*Palythoa*), and there are many other instances. Sponges often also grow in very close association with certain low forms of plants (Algæ).

The position of the Porifera in the animal series is unquestionably among the Metazoa. The view that they are compound Protozoa is now no longer maintained since the significance of the facts of their development has been fully recognised. A Sponge is to be regarded as a colony of Protozoa only in the sense in which the same may be said of one of the higher animals. It consists of a complex of cells, some of which have a considerable degree of independence, and some of which have a close resemblance to certain Protozoa; but the same is true of one of the higher animals, the difference being one of degree and not of kind. Like the rest of the Metazoa, the Sponge develops from the oosperm by a process of yolk-division.

But the Porifera are perhaps somewhat nearer the Protozoa than are any of the other types of Metazoa; and among the Protozoa they appear to approach nearest to certain colonial Flagellata. The genus *Proterospongia* (Fig. 59), already referred to (p. 80), appears to be the member of the latter group which of all known forms most closely resembles a sponge. *Proterospongia* consists of a colony of collared Flagellates (Choanoflagellata)

embedded in a mass of gelatinous substance, in which there are also amœboid zooids similar to the amœboid wandering cells of Sponges.

But, while the Porifera are clearly Metazoa, and not Protozoa, there is some room for difference of opinion as regards their relationships to the Cœlenterata, with which great phylum they have been sometimes amalgamated. The reasons for and against such an arrangement will be discussed in considering the general relationships of the Cœlenterata.

SECTION IV

PHYLUM CŒLEENTERATA

THE possession of an internal cavity lined by a special layer of cells,—the endoderm,—in which the digestive and absorptive functions are centred, distinguishes all the remaining groups of Metazoa from the Parazoa or Sponges. The former are grouped together under the comprehensive title of *Enterozoa*, or animals with enteric cavity. The simplest Enterozoa have an internal cavity in which there is no separation between the enteric or digestive cavity and the cœlome or body-cavity—one continuous space representing both and opening on the exterior by the aperture of the mouth. These constitute the phylum *Cœlenterata*. They are all animals of a low type of organisation with a conspicuous radial symmetry, disguising, in some cases, a more obscure bilateral arrangement, which may be more primitive.

The most familiar examples of Cœlenterata are the horny, seaweed-like “Zoophytes,”—or, as they are sometimes called, “Corallines,” to be picked up on every sea-beach,—Jelly-fishes, Sea-anemones, and Corals. The phylum is divided into four classes as follows:—

Class 1. HYDROZOA, including the Fresh-water Polypes, Zoophytes, many Jelly-fishes,—mostly of small size,—a few Stony Corals, and the peculiar Palæozoic fossils known as *Graptolites*.

Class 2. SCYPHOZOA, including most of the large Jelly-fishes.

Class 3. ACTINOZOA, including the Sea-anemones, and the vast majority of Stony Corals.

Class 4. CTENOPHORA, including certain peculiar Jelly-fishes known as “Comb-jellies.”

CLASS I.—HYDROZOA.

1. EXAMPLE OF THE CLASS—*Obelia*.

General Structure.—*Obelia* is a common zoophyte occurring in the form of a delicate, whitish or light brown, almost fur-like

growth on seaweeds, the wooden piles of piers, etc. It consists of branched filaments about the thickness of fine sewing-cotton: of these, some are closely adherent to the weed or timber, and serve for attachment, while others are given off at right angles, and present at intervals short lateral branches, each terminating in a bud-like enlargement.

The structure is better seen under a low power of the microscope. The organism (Fig. 96) is a colony, consisting of a common stem or axis, on which are borne numerous *zooids*. The axis consists of a horizontal portion (*hydrorhiza*) resembling a root or creeping stem, and of vertical axes, which give off short lateral branches in an alternate manner, bearing the *zooids* at their ends. At the proximal ends of the vertical axes the branching often becomes more complex: the offshoots of the main stem, instead of ending at once in a *zooid*, send off branches of the third order on which the *zooids* are borne. In many cases, also, branches are found to end in simple club-like dilatations (*Bd. 1, 2*): these are immature *zooids*.

The large majority of the *zooids* have the form of little conical structures (*P. 1—P. 4*), each enclosed in a glassy, cup-like investment or *hydrotheca* (*h.th*), and produced distally into about two dozen arms or *tentacles* (*t*): these *zooids* are the *polypes* or *hydranths*. Less numerous, and found chiefly towards the proximal region of the colony, are long cylindrical bodies or *blastostyles* (*bls*), each enclosed in a transparent case, the *gonotheca* (*g.th*), and bearing numerous small lateral offshoots, varying greatly in form according to their stage of development, and known as *medusa-buds* (*m.bd*). By studying the development of these structures, and by a comparison with other forms, it is known that both *blastostyles* and *medusa-buds* are *zooids*, so that the colony is *trimorphic*, having *zooids* of three kinds.

To make out the structure in greater detail, living specimens should be observed under a high power. A *polype* is then seen to consist of a somewhat cylindrical, hollow *body*, of a yellowish colour, joined to the common stem by its proximal end, and produced at its distal end into a conical elevation, the *manubrium* or *hypostome* (*mnb*), around the base of which are arranged the twenty-four *tentacles* in a circle. Both *body* and *manubrium* are hollow, containing a spacious cavity, the *enteron* (*ent*), which communicates with the outer world by the *mouth* (*mth*), an aperture placed at the summit of the *manubrium*. The *mouth* is capable of great dilatation and contraction, and accordingly the *manubrium* appears now conical, now trumpet-shaped. Under favourable circumstances small organisms may be seen to be caught by the *polypes* and carried towards the *mouth* to be swallowed.

The *hydrotheca* (*h.th*) has the form of a vase or wine-glass, and is perfectly transparent and colourless. A short distance from its

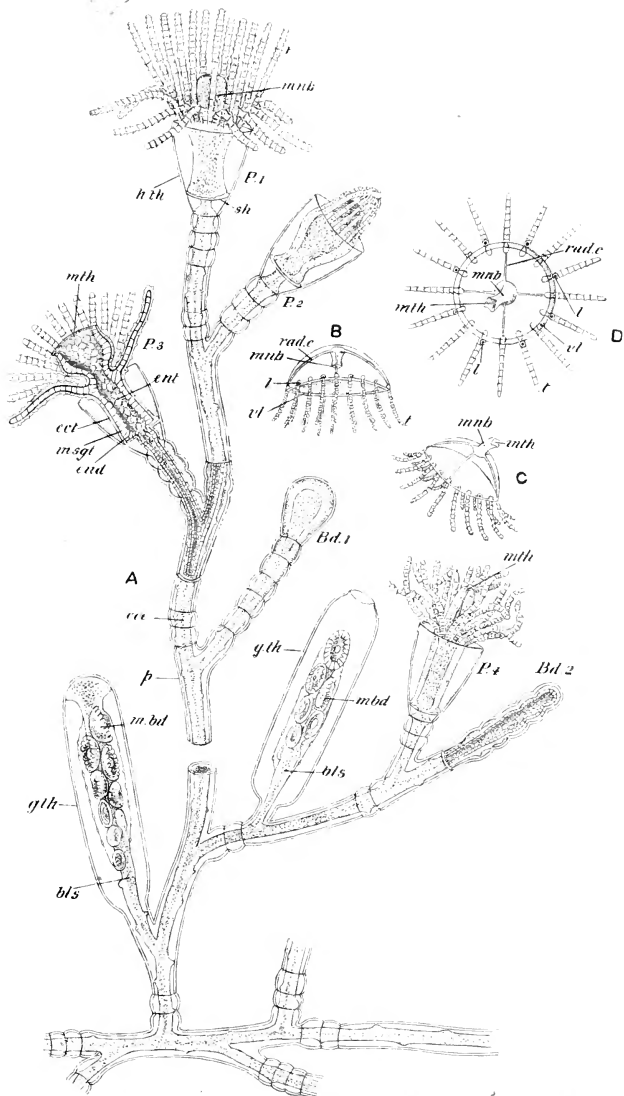

FIG. 96.—**Obelia** sp. A, portion of a colony with certain parts shown in longitudinal section; B, medusa; C, the same with reversed umbrella; D, the same, oral aspect; Bd. 1, 2, buds; bls, blastostyle; ca, conosarc; ect, ectoderm; end, endoderm; ent, enteric cavity; g.th, gonotheca; h.th, hydrotheca; l, lithocyst; m.bd, medusa-bud; mnb, manubrium; msgl, mesogloea; mth, mouth; p, perisarc; P. 1, 2, 3, polypes; rad. c, radial canal; t, tentacle; vt, velum.

narrow or proximal end, it is produced inwards into a sort of circular shelf (*sh*), perforated in the centre: upon this the base of the polype rests, and through the aperture it is continuous with the common stem. When irritated—by a touch or by the addition of alcohol or other poison—the polype undergoes a very marked contraction: it suddenly withdraws itself more or less completely into the theca, and the tentacles become greatly shortened and curved over the manubrium (*P. 2*).

The various branches of the common stem show a very obvious distinction into two layers: a transparent, tough, outer membrane, of a yellowish colour and horny consistency, the *perisarc* (*p*), and an inner, delicate, granular layer, the *cœnosarc* (*cœ*), continuous by a sort of neck or constriction with the body of each hydranth. The *cœnosarc* is hollow, its tubular cavity being continuous with the cavities of the polypes, and containing a fluid in which a flickering movement may be observed, due, as we shall see, to the action of cilia. At the base of each zooid or branch the *perisarc* presents several annular constrictions, giving it a ringed appearance: for the most part it is separated by an interval from the *cœnosarc*, but processes of the latter extend outwards to it at irregular intervals, and in the undeveloped zooids (*Bd. 2*) the two layers are in close apposition.

In the blastostyle both mouth and tentacles are absent, the zooid ending distally in a flattened disc: the hydrotheca of a polype is represented by the gonotheca (*g.th*), which is a cylindrical capsule enclosing the whole structure, but ultimately becoming ruptured at its distal end to allow of the escape of the medusa-buds. These latter are, in the young condition, mere hollow offshoots of the blastostyle: when fully developed they have the appearance of saucers attached by the middle of the convex surface to the blastostyle, produced at the edge into sixteen very short tentacles, and having a blunt process, the manubrium, projecting from the centre of the concave surface. They are ultimately set free through the aperture in the gonotheca as little *medusæ* or jelly-fish (*B—D*), which will be described hereafter.

The **microscopical structure** of a polype (Fig. 97) reminds us, in its general features, of that of such a simple sponge as *Ascetta*, but with many characteristic differences. The body is composed of two layers of cells, the ectoderm (*ect*) and the endoderm (*end*): between them is a very delicate transparent membrane, the *mesoglœa* or *supporting lamella* (*msgl*), which, unlike the intermediate layer of sponges, contains no cells and is practically structureless. The same three layers occur in the manubrium, the ectoderm and endoderm being continuous with one another at the margin of the mouth. The tentacles are formed of an outer layer of ectoderm, then a layer of mesoglœa, and finally a solid core of large endoderm cells arranged in a single series. The

cœnosarc, blastostyles, and medusa-buds all consist of the same layers, which are thus continuous through the entire colony.

The perisarc or transparent outer layer of the stem shows no cell-structure, but only a delicate lamination. It is, in fact, not a cellular membrane or epithelium, like the ectoderm and endoderm, but a *cuticle*, formed, layer by layer, as a secretion from the ectoderm cells (see p. 32). It is composed of a substance of chitinoid or horn-like consistency, and, like the lorica of many Protozoa, serves as a protective external skeleton. When first formed it is of course in contact with the ectoderm, but when the full thickness is attained the latter retreats

from it, the connection being maintained only at irregular intervals. In the same way the hydro- and gono-theæ are cuticular products of the polypes and blastostyles respectively: in the young condition both occur in the form of a closely fitting investment of the knob-like rudiment of the zooid (Fig. 96, *Bd. 1, 2*).

The ectoderm has the general character of a columnar epithelium (see p. 26),

but exhibits considerable differentiation of its component cells. It is mainly composed of large conical cells with their bases outwards, and having between their narrow inner ends clumps of small rounded *interstitial cells*, and occasional large branched *nerve-cells* (Fig. 99, *nv.c*). The tentacles and the manubrium contain, in addition, a layer of unstriped *muscle-fibres* between the ectoderm and the mesogloæ: they are arranged longitudinally, and serve for the rapid shortening of the tentacles (Fig. 99, *mf*). This muscular layer is a derivative of the ectoderm, and may be looked upon as a rudimentary mesoderm.

Embedded in the ectoderm are numerous clear ovoid bodies, the

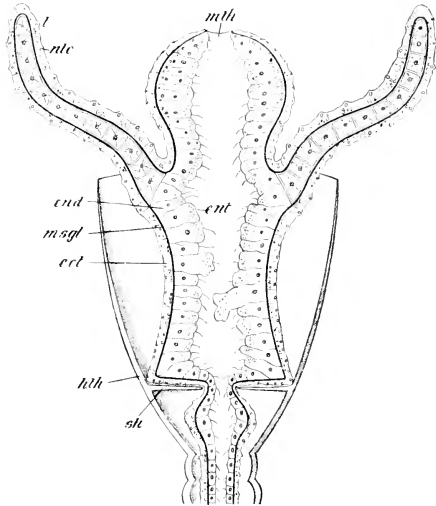

FIG. 97.—*Obelia* sp. Vertical section of a polype, highly magnified; *ect*, ectoderm; *end*, endoderm; *ent*, enteric cavity; *h.th.*, hydrotheca; *msgl.*, mesogloæ; *mth.*, mouth; *ntc.*, nematocysts; *sh.*, shelf-like prolongation of hydrotheca; *t.*, tentacle.

stinging-capsules or *nematocysts* (Figs. 97—99, *ntc*), organs closely resembling those of *Epistylis umbellaria* (p. 95), and, like them, serving as weapons of offence. Each consists (Fig. 98, *A*) of a tough ovoid capsule, full of fluid, and invaginated at one end in the form of a hollow process continued into a long, coiled, hollow thread. The whole apparatus is developed into an interstitial cell called a *cnidoblast* (*cnb*), which, as it approaches maturity, migrates towards

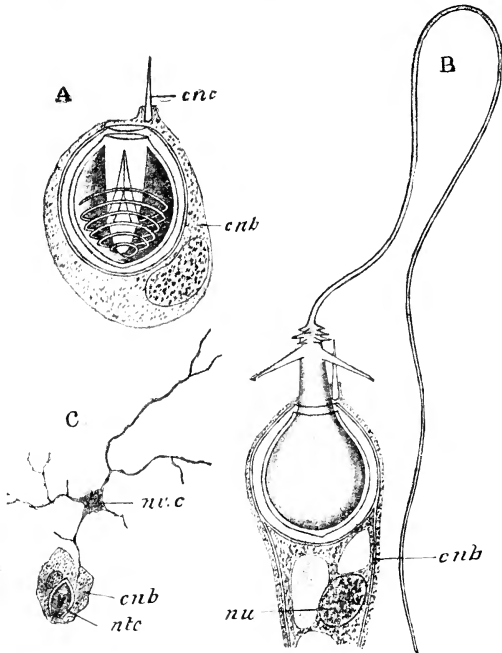

FIG. 98.—Nematocysts of **Hydra**. *A*, undischarged; *B*, discharged; *C*, nerve-supply; *cnb*, cnidoblast; *cnc*, cnidocil; *nu*, nucleus; *ntc*, nematocyst; *n.c.*, nerve-cell. (From Parker's *Biology*, after Schneider.)

the surface and becomes embedded in one of the large ectoderm cells. At one point of its surface the cnidoblast is produced into a delicate protoplasmic process, the *cnidocil* or *trigger-hair* (*cnc*): when this is touched—for instance by some small organism brought into contact with the waving tentacle—the cnidoblast undergoes a sudden contraction, and the pressure upon the stinging capsule causes an instantaneous eversion of the thread (*B*), at the

base of which are minute barbs. The threads are poisonous, and exert a numbing effect on the animals upon which *Obelia* preys.

The endoderm also has the general character of a columnar epithelium. In the body of the polype the cells are very large and have the power of sending out pseudopods at their free ends (Fig. 97), which apparently seize and ingest minute portions of the partly-digested food. As in many Protozoa, the pseudopods may be drawn in and long flagella protruded, the contraction of which causes a constant movement of the food particles in the enteron. Amongst these large cells are narrow cells with very granular protoplasm: they are gland-cells, and secrete a digestive juice. In the manubrium a layer of endodermal muscle-fibres has been described taking a transverse direction, and so serving to antagonise the longitudinal muscles and contract the cavity. In the tentacles (Figs. 97 and 99) the endoderm (*end*) consists of a single row of short cylindrical cells, nearly cubical in longitudinal section: their protoplasm is greatly vacuolated and their cell-walls are so thick that they may be considered as forming a sort of internal skeleton to the tentacles.

The structure of the **medusæ**—formed, as we have seen, by the development of medusa-buds liberated from a ruptured gonotheca—yet remains to be considered. The convex outer surface of the bell or umbrella (Fig. 96, *B—D*) by which the zooid was originally attached to the blastostyle is distinguished as the *ex-umbrella*, the concave inner surface as the *sub-umbrella*.

From the centre of the sub-umbrella proceeds the manubrium (*mnb*), at the free end of which is the four-sided mouth (*mth*). Very commonly, as the medusa swims the umbrella becomes turned inside out, the sub-umbrella then forming the convex surface and the manubrium springing from its apex (Fig. 96, *C*, and Fig. 100, *A*).

The mouth (Figs. 96, 97, 100, and 101, *mth*) leads into an enteric cavity which occupies the whole interior of the manubrium, and

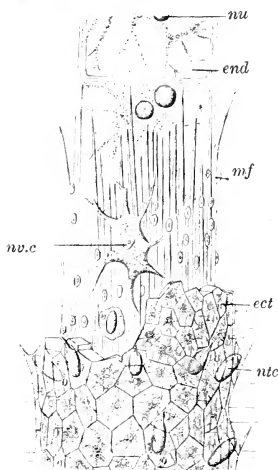

FIG. 99.—Tentacle of **Eucopella**. The lower part of the figure shows the external surface, in the middle part the ectoderm is removed and the muscular and nervous layer exposed, in the upper part these latter are removed so as to show the core of endoderm cells. *ect*, ectoderm; *end*, endoderm; *mf*, muscle-fibres; *ntc*, nematocyst; *nu*, nucleus; *n.v.c.*, nerve-cell. (After von Lendenfeld.)

from its dilated base sends off four delicate tubes, the *radial canals* (*rad. c.*), which pass at equal distances from each other through the substance of the umbrella to its margin, where they all open into a *circular canal* (*circ. c.*), running parallel with and close to the margin. By means of this system of canals the food, taken in at the mouth and digested in the manubrium, is distributed to the entire medusa.

The edge of the umbrella is produced into a very narrow fold or shelf, the *velum* (Fig. 101, *vl*), and gives off the tentacles (*t*), which are sixteen in number in the newly-born medusa (Fig. 96), very numerous in the adult (Fig. 100). At the bases of eight of the tentacles—two in each quadrant—are minute globular sacs (*l*), each containing a calcareous particle or *lithite*. These are the *marginal sense-organs* or *lithocysts*: they were formerly considered

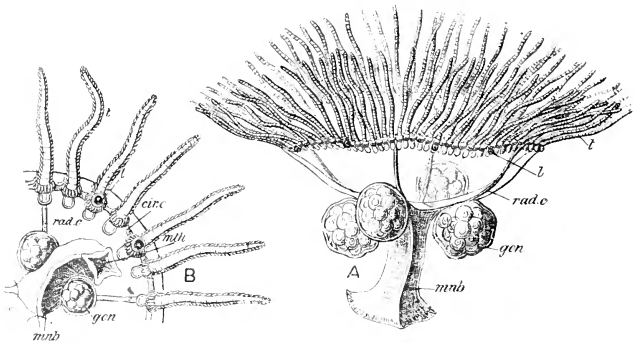

FIG. 100.—*Obelia* sp. A, mature medusa swimming with everted umbrella; B, one-quarter of the same, oral aspect; *circ. c.* circular canal; *gon.* gonad; *l.* lithocyst; *mnb.* manubrium; *mth.* mouth; *rad. c.* radial canal; *t.* tentacle. (After Haeckel.)

to be organs of hearing, and are hence frequently called *otocysts*: in all probability their function is to guide the medusa by enabling it to judge of the direction in which it is swimming. The marginal organs, in this case, may therefore be looked upon as organs of the sense of direction.

The manubrium (Fig. 101, *mnb*) of the medusa consists of precisely the same layers as that of the hydranth—ectoderm, mesogloea, and endoderm. The ectoderm is continued on to the sub-umbrella, and then round the margin of the bell on to the ex-umbrella, so that both surfaces of the bell are covered with ectoderm. The endoderm is continued from the base of the enteric cavity into the radial canals and thence to the circular canal, so that the whole canal-system is lined by endoderm. In the portions of the bell between the radial canals there is found,

between the outer and inner layers of ectoderm, a thin sheet of endoderm, the *endoderm-lamella* (*end. lam.*), which stretches between adjacent radial canals and between the circular canal and the enteric cavity. In the bell, as in the manubrium, a layer of mesogloea everywhere intervenes between ectoderm and endoderm.

The velum (*vl.*) consists of a double layer of ectoderm and a middle one of mesogloea: there is no extension of endoderm into it. The tentacles, like those of the hydranth, are formed of a core of endoderm covered by ectoderm, the cells of the latter being abundantly supplied with stinging-capsules.

Comparison of Polype and Medusa.—Striking as is the difference between a polype and a medusa, they are strictly homologous

structures, and the more complex medusa is readily derivable from the simpler polype-form. It is obvious, in the first instance, that the apex of the umbrella corresponds with the base of a hydranth (Fig. 102, *A* and *D*), being the part by which the

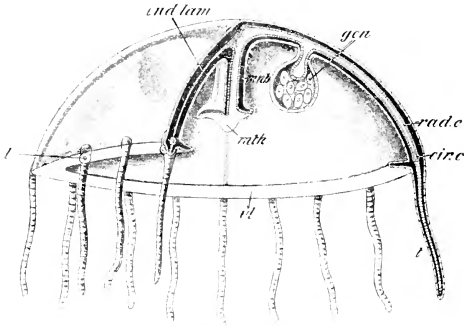

FIG. 101.—Dissection of a **medusa** with rather more than one-quarter of the umbrella and manubrium cut away (diagrammatic). The ectoderm is dotted, the endoderm striated, and the mesogloea black; *circ. c.* circular canal; *end. lam.* endoderm lamella; *gon.* gonad; *l.* lithocyst; *manub.* manubrium; *mth.* mouth; *rad. c.* radial canal; *vl.* velum.

zooid is attached in each case to the parent stem: the mouth with the manubrium are also obviously homologous structures in the two cases. Suppose the tentacular region of a polype to be pulled out, as it were, into a disc-like form (*B*), and afterwards to be bent into the form of a saucer (*C*) with the concavity distal, *i.e.* towards the manubrium. The result of this would be a medusa-like body (*C, C'*) with a double wall to the entire bell, the narrow space between the two layers containing a prolongation of the enteron (*ent. cav'*) and being lined with endoderm. From such a form the actual condition of things found in the medusa would be produced by the continuous cavity in the bell being for the most part obliterated by the growing together of its walls so as to form the endoderm-lamella (*D', end. lam.*), and remaining only along four meridional areas—the radial canals (*rad. c.*), and a circular area close to the edge of the bell—the circular canal (*circ. c.*).

While both polype and medusa are radially symmetrical, the increase in complexity of the medusa is accompanied by a differentiation of the structures lying along certain radii. If a polype is projected on a plane surface (Fig. 103, *A*), taken at right angles to its long axis, a large number of radii—about

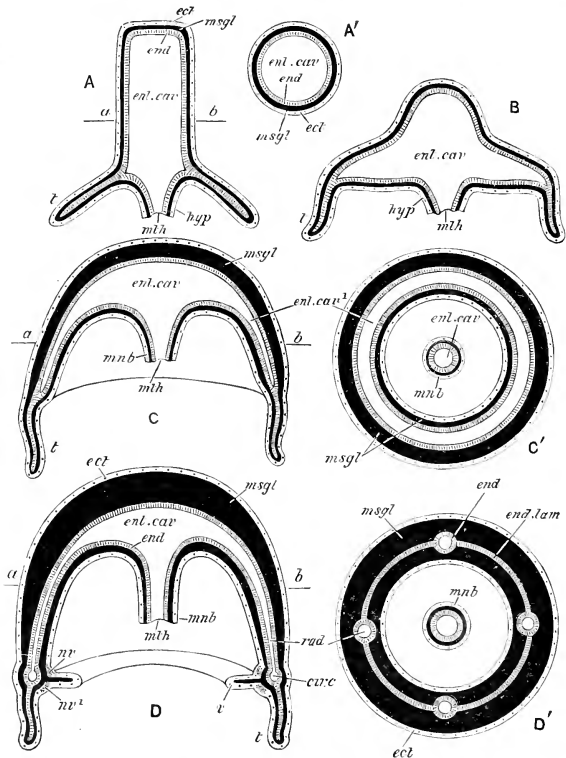

FIG. 102.—Diagram illustrating the derivation of the **medusa** from the **polype**. *A*, longitudinal, and *A'*, transverse section (along the line *ab*) of polype-form with extended tentacular region; *B*, polype-form with extended tentacular region; *C*, vertical, and *C'*, transverse section (along the line *ab*) of form with tentacular region extended into the form of a bell; *D*, vertical, and *D'*, transverse section (along the line *ab*) of medusa. The ectoderm is dotted, the endoderm striated, and the mesoglea black. *cir. c.* circular canal; *ect.* ectoderm; *end.* endoderm; *end. lam.* endoderm lamella; *ent. cav.* enteric cavity; *hyp.* hypostome or manubrium; *mnb.* manubrium; *msgl.* mesoglea; *mth.* mouth; *nv., nv'*, nerve-rings; *t.* tentacle; *v.* velum. (From Parker's *Biology*.)

twenty-four—can be drawn from the centre outwards, all passing through similar parts, *i.e.* along the axis of a tentacle and through similar portions of the body and manubrium. But in the medusa (*B*) the case is different. The presence of the four radial canals allows us to distinguish four *principal radii*

or *per-radial*. Halfway between any two per-radial radii a *radius of the second order*, or *inter-radius*, may be taken; halfway between any per-radius and the inter-radius on either side a *radius of the third order*, or *ad-radius*, and halfway between any ad-radius and the adjacent per- or inter-radius, a *radius of the fourth order*, or *sub-radius*. Thus there are four per-radial, four inter-radial, eight ad-radial, and sixteen sub-radial. In *Obelia* the radial canals, the angles of the mouth, and four of the tentacles are per-radial, four more tentacles are inter-radial, and the remaining eight tentacles, bearing the lithocysts, are ad-radial. The sub-radial are of no importance in this particular form.

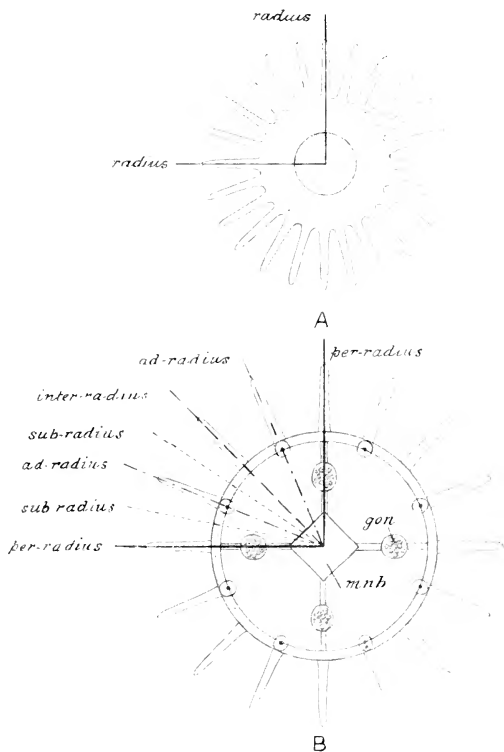

FIG. 103.—Projections of **polype** (A) and **medusa** (B), showing the various orders of radii gon. gonad; mnh. manubrium.

Reproduction.—In the description of the fixed *Obelia*-colony no mention was made of cells set apart for reproduction, like the ova and sperms of a sponge. As a matter of fact, such sexual

cells are found only—in their fully developed condition at least—in the medusæ. Hanging at equal distances from the sub-umbrella, in immediate relation with the radial canal and therefore per-radial in position, are four ovoid bodies (Figs. 100 and 101, *gon*), each consisting of an outer layer of ectoderm continuous with that of the sub-umbrella, an inner layer of endoderm continuous with that of the radial canal and enclosing a prolongation of the latter, and of an intermediate mass of cells which have become differentiated into ova or sperms. As each medusa bears organs of one sex only (testes or ovaries, as the case may be), the individual medusæ are *diocious*. It will be noticed that the gonad has the

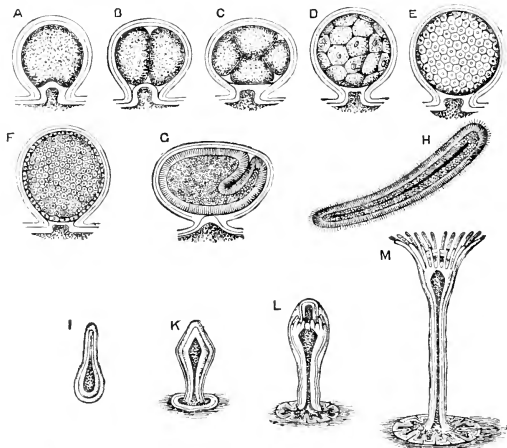

FIG. 104.—Stages in the development of two Zoophytes (A—H, *Laomedea*, I—M, *Eudendrium*) allied to *Obelia*; A—F, stages in segmentation; G, the planula enclosed in the maternal tissues; H, the free-swimming planula; I—M, fixation of the planula and development of the hydrula. (From Parker's *Biology*, after Allman.)

same general structure as an immature zooid—an outpushing of the body-wall consisting of ectoderm and endoderm, and containing a prolongation of the enteric cavity.

Development.—When the gonads are ripe, the sperms of the male medusæ are shed into the water and carried by currents to the females, impregnating the ova, which thus become oosperms or unicellular embryos. The oosperm undergoes complete segmentation (Fig. 104, A—F), and is converted into an ovoidal body called a *planula* (G, H), consisting of an outer layer of ciliated ectoderm cells and an inner mass of endoderm cells in which a space appears, the rudiment of the enteron. The planula swims freely for a time (H), then settles down on a piece of timber, sea-

weed, &c., fixes itself by one end (*K*), and becomes converted into a *hydrula* or simple polype (*L*, *M*), having a disc of attachment at its proximal end, and at its distal end a manubrium and circlet of tentacles. Soon the hydrula sends out lateral buds, and, by a frequent repetition of this process, becomes converted into the complex *Obelia*-colony with which we started.

This remarkable life-history furnishes the first example we have yet met with among the Metazoa of *alternation of generations*, or *metagenesis* (see p. 41). The *Obelia*-colony is sexless, having no gonads, and developing only by the asexual process of budding; but certain of its buds—the medusæ—develop gonads, and from their impregnated eggs new *Obelia*-colonies arise. We thus have an alternation of an *asexual generation*, or *agamobium*—the *Obelia*-colony, with a *sexual generation*, or *gamobium*—the medusa.

2. GENERAL STRUCTURE AND CLASSIFICATION.

The Hydrozoa may be defined as multicellular animals in which the cells are arranged in two layers, ectoderm and endoderm, separated by a gelatinous, non-cellular mesogloea, and enclosing a continuous digestive cavity which communicates directly with the exterior by a single aperture—the mouth—and is lined throughout by endoderm. The ectoderm consists of epithelial cells, interstitial cells, muscle-fibres, and nerve-cells. Certain of the interstitial cells give rise to characteristic organs of offence—the stinging-capsules. The endoderm consists of flagellate or amœboid cells, gland-cells, and sometimes muscle-fibres. There are two main forms of zooids, polypes or nutritive zooids, which are usually sexless, and medusæ or reproductive zooids. In correspondence with its locomotive habits, the medusa attains a higher degree of organisation than the polype, having more perfect muscular and nervous systems, distinct sense-organs, and a digestive cavity differentiated into central and peripheral portions, the latter taking the form of radial and circular canals. The reproductive products are discharged externally, and are very commonly, though not always, of ectodermal origin.

Many Hydrozoa agree with *Obelia* in exhibiting alternation of generations, the asexual generation being represented by a fixed, more or less branched, hydroid colony, the sexual generation by a free-swimming medusa. In other forms there are no free medusæ, but the hydroid colony produces fixed reproductive zooids. In others, again, there is no hydroid stage, the organism existing only in the medusa-form. Then, while in most instances the only skeleton or supporting structure is the horny perisarc, there are some forms in which the cœnosarc secretes a skeleton of calcium carbonate, forming a massive stony structure or *coral*. Lastly, there are colonial forms which, instead of remaining fixed, swim

or float freely on the surface of the ocean, and such pelagic species are always found to exhibit a remarkable degree of *polymorphism*, the zooids being of very various forms and performing diverse functions.

Thus we have zoophyte colonies known to produce free medusæ, zoophyte colonies known not to produce free medusæ, and medusæ known to have no zoophyte stage. Moreover, there are many medusæ of which the life-history is unknown, so that it is uncertain whether or not a zoophyte stage is present. It is also found that in some cases closely allied zoophytes produce very diverse medusæ, while similar medusæ, in other cases, may spring from very different zoophytes. For these reasons a sort of double classification of the Hydrozoa has come about, some zoologists approaching the group from the point of view of the zoophyte, others from that of the medusa. On the whole the following scheme seems best adapted for bringing before the beginner the leading modifications of the class.

ORDER 1.—LEPTOLINÆ.

Hydrozoa in which there is a fixed zoophyte stage, and in which the sense-organs are exclusively ectodermal.

Sub-Order a.—Anthomedusæ.

Leptolinæ in which the polypes are not protected by hydrothecæ or the reproductive zooids by gonothecæ; the medusæ bear the gonads on the manubrium and have no lithocysts.

Sub-Order b.—Leptomedusæ.

Leptolinæ in which hydro- and gono-thecæ are present; the medusæ bear the gonads in connection with the radial canals and usually have lithocysts.

ORDER 2.—TRACHYLINÆ.

Hydrozoa in which no fixed zoophyte stage is known to occur, all members of the group being locomotive medusæ, some of which have been proved to develop directly from the egg. The sense-organs are formed partly of endoderm.

Sub-Order a.—Trachymedusæ.

Trachylinæ in which the tentacles spring from the margin of the umbrella, and the gonads are developed in connection with the radial canals.

Sub-Order b.—Narcomedusæ.

Trachylinæ in which the tentacles spring from the ex-umbrella, some distance from the margin, and the gonads are developed in connection with the manubrium.

ORDER 3.—HYDROCORALLINA.

Hydrozoa in which a massive skeleton of calcium carbonate is secreted from the cœnosarc, the dried colony being a coral.

ORDER 4.—SIPHONOPHORA.

Pelagic Hydrozoa in which the colony usually exhibits extreme polymorphism of its zooids.

ORDER 5.—GRAPTOLITHIDA.

An extinct group of Hydrozoa, found only in rocks of Palæozoic age, in the form of the fossilised perisarc of the branched colonies.

Systematic Position of the Example.

Obelia, in virtue of the possession of gono- and hydro-thecæ, and of gonads formed in connection with the radial canals, belongs to the sub-order Leptomedusæ. It is placed in the family *Campanulariidae*, distinguished by having cup-shaped thecæ borne at the ends of distinct branchlets: the genus *Obelia* is distinguished from other genera of the same family by the fact that the reproductive zooids are free-swimming medusæ.

ORDER 1.—LEPTOLINÆ.

The more typical members of this group agree in all essential respects with *Obelia*, consisting of branched colonies bearing two principal forms of zooids, which serve for nutritive and reproductive purposes respectively.

General Structure.—The form and size of the colonies are subject to great variation: they may be little insignificant tufts growing on shells, sea-weeds, &c., or may take the form of complex trees three feet in height, and containing many thousand zooids. The hydranths may be colourless and quite invisible to the naked eye, or, as in some *Tubulariæ* (Fig. 106, 5), may be brilliantly coloured, flower-like structures, nearly an inch in diameter. The medusæ may be only just visible to the naked eye, or, as in *Æquorea*, may attain a diameter of 380 mm., or about 15 inches: they are often seen with great difficulty owing to the bubble-like transparency of the umbrella; but frequently the manubrium is brightly coloured, or brilliant dots of colour—the *ocelli* or eye-spots—may occur around the margin of the umbrella. They are also frequently phosphorescent, the phosphorescence of the ocean being often due to whole fleets of medusæ liberated in thousands from the hydroid colonies beneath the surface.

The two sub-orders of Leptolinæ are distinguished by the arrangement of the **perisarc**. In the *Anthomedusæ*, of which

Bougainvillea (Fig. 105) is a good example, the cuticle stops short at the bases of the hydranths, and the reproductive zooids are not enclosed in gonothecæ. It is for this reason that, in classifications founded on the zoophyte stage, the Anthomedusæ are called *Gymnoblastera* or naked-budded zoophytes (see also Fig. 106, 1, 4, 5). In the Leptomedusæ the cuticle is usually of a firmer consistency than

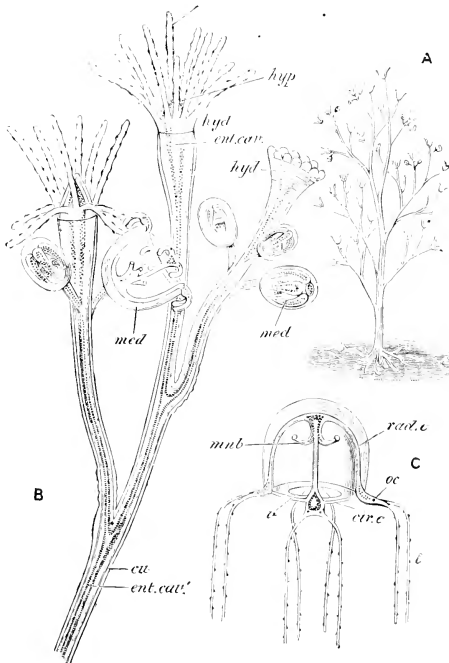
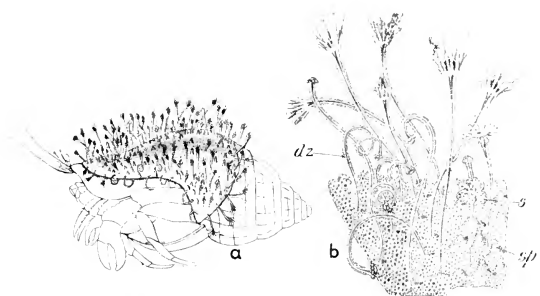

FIG. 105.—*Bougainvillea ramosa*. A, entire colony, natural size; B, portion of the same magnified; C, immature medusa. *cir. c.* circular canal; *cu.* cuticle or perisarc; *ent. cav.* enteric cavity; *hyd.* polype or hydranth; *hyp.* hypostome or manubrium; *med.* medusa; *mnb.* manubrium; *rad. c.* radial canal; *t.* tentacle; *v.* velum. (From Parker's *Biology*, after Allman.)

in the first sub-order, and furnishes hydrothecæ for the hydranths and gonothecæ for the reproductive zooids: they are hence often classified as *Calyptoblastera* or covered-budded hydroids. To this group belong the commonest species of hydroids found on the sea-shore, and often mistaken for seaweeds—the “Sea-firs” or Sertularians.

The medusæ also exhibit characteristic differences in the two sub-orders. In the Anthomedusæ the umbrella is usually strongly arched, and may even be conical or mitre-shaped (Figs. 105;

106, 7; 110, 1 and 2): its walls are thick, owing to a great development of the gelatinous mesogloea of the ex-umbrella, that of the sub-umbrella remaining thin; and the velum is considerably wider than in Obelia. But the most important characteristics are the facts that the gonads (*gon*) are developed on the manubrium and that lithocysts are absent. Sense-organs are, however, present in the form of specks



1. *Hydraactinia*

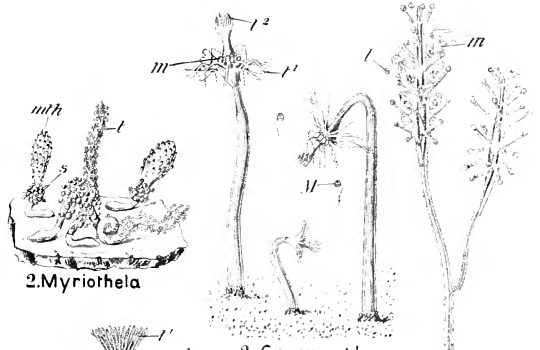

2. *Myriothela*

3. *Corymorpha*

4. *Syncoryne*

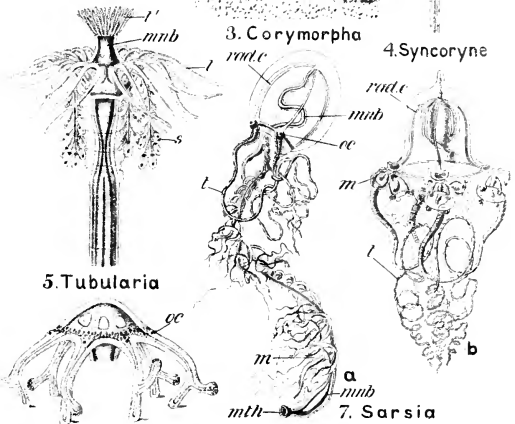

5. *Tubularia*

6. *Clavatella*

7. *Sarsia*

FIG. 106.—Various forms of **Leptolinae**. In 1, *a* shows the entire colony, *b* a portion highly magnified; in 7, *a*, *b* a species producing medusa-buds from the manubrium, *b* from the bases of the tentacles; *dz*, dactylozooids; *m*, and *M*, medusae; *mnb*, manubrium; *mth*, mouth; *oc*, eye-spots; *rad. c.*, radial canals; *s*, sporosacs; *sp*, spines; *t*, *t*¹, *t*², tentacles.

of red or black pigment at the bases of the tentacles. These *ocelli* (*oc*) consist of groups of ectoderm cells containing pigment, and it has been proved experimentally that they are sensitive to light: they are, in fact, the simplest form of eyes. In the *Leptomedusæ* the umbrella is usually less convex, thinner, and of softer consistency than in the *Anthomedusæ*, the gonads are developed as buds formed in connection with the radial canals and projecting from the sub-umbrella, the velum is feebly developed, and sense-organs take the form sometimes of ocelli, but usually of lithocysts.

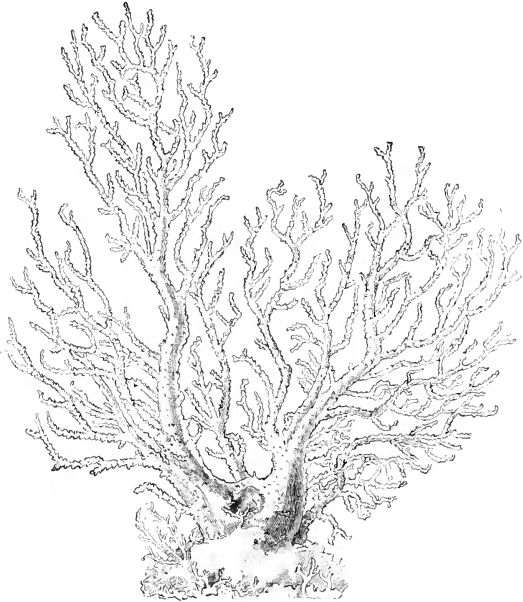

FIG. 107.—*Ceratella fusca*. About nat. size. (From Hickson, after Baldwin Spencer.)

In the majority of *Leptolinae* the *cœnosarc*, as in *Obelia*, consists of a more or less branched structure attached to stones, timber, seaweeds, shells, &c., by a definite root-like portion (*hydrorhiza*). The curious genus *Hydractinia* (Fig. 106, *I*) is remarkable for possessing a massive *cœnosarc*, consisting of a complex arrangement of branches which have undergone fusion, so as to form a firm brownish crust on the surfaces of dead gastropod shells inhabited by Hermit-crabs. The constant association of *Hydractinia* with

Hermit-crabs is a case of *commensalism*: the hydroid feeds upon minute fragments of the Hermit-crab's food, and is thus its com-

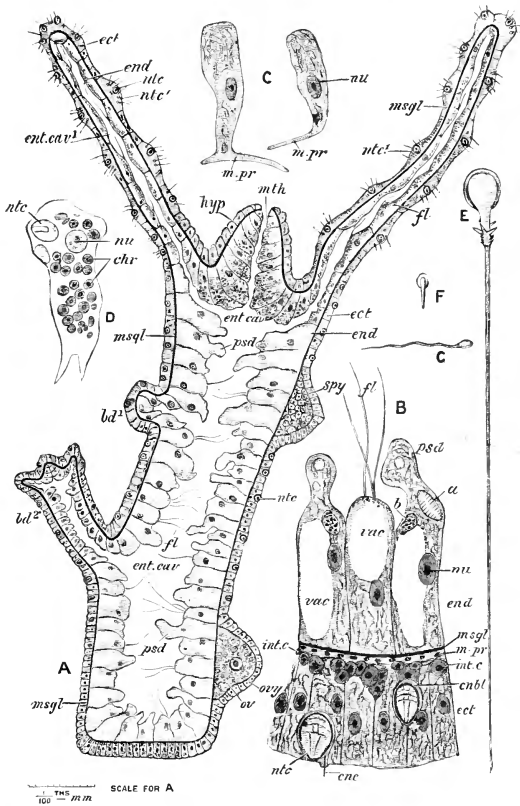

FIG. 108.—**Hydra.** A, vertical section of entire animal; B, portion of transverse section, highly magnified; C, two large ectoderm cells; D, endoderm cell of *H. viridis*; E, large nematocyst; F, small nematocyst; G, sperm. a, ingested diatom; ba, 1, 2, buds; chr, chromatophores; cnbl, cnidoblast; cnc, cnidocil; ect, ectoderm; end, endoderm; ent. cav, enteric cavity; ent. cav¹, its prolongation into the tentacles; fl, flagellum; hyp, hypostome or manubrium; int. c, interstitial cells; m. pr, muscle-processes; mth, mouth; msq, mesoglea; ntc, large, and ntc', small nematocysts; nu, nucleus; ov, ovum; orv, ovary; psd, pseudopods; spy, spermary; vac, vacuole. (From Parker's *Elementary Biology*, after Lankester and Howes.)

mensal or messmate; and the Hermit-crab is protected from its enemies by the presence of the inedible, stinging hydroid.

Hydractinia belongs to the Anthomedusæ: the Leptomedusan *Clathroozoon*, an Australian genus, resembles it in having branched and intertwined cœnosarcal tubes, the perisarc of which undergoes fusion; but the complex mass thus produced, instead of forming an incrustation on a shell, is a large, abundantly branched, tree-like structure, resembling some of the fan-corals or Gorgonacea (*vide* p. 201). *Ceratella* (Fig. 107) has a similar fan-coral-like appearance, with a branching axis composed of numerous intertwining and anastomosing tubes; but while *Clathroozoon* possesses thecæ, in *Ceratella* they are absent.

A great simplification of the colony is produced in *Myriothela* (Fig. 106, 2), in which the short cœnosarc bears a single large terminal hydranth, and gives off numerous slender branches which bear the reproductive zooids (*s*). Even greater simplicity is found in *Corymorpha* (3), in which the entire organism consists of a single-stalked polype, from the tentacular region of which the medusæ (*m*) arise.

But the simplest members of the whole class, with the exception of one or two imperfectly known forms which will be referred to below, are the Fresh-water Polypes of the genus *Hydra*. The entire organism (Figs. 27 and 108) consists of a simple cylindrical



FIG. 109.—*Protohydra leuckartii*. (From Chun, after Greeff.)
The mouth is to the left, the disc of attachment to the right.

body with a conical hypostome and a circlet of six or eight tentacles. It is ordinarily attached, by virtue of a sticky secretion from the proximal end, to weeds, &c., but is capable of detaching itself and moving from place to place after the manner of a looping caterpillar. The tentacles are hollow, and communicate freely with the enteron. Both the body and the tentacles are highly contractile, the contractions being effected by means of a layer of fibres which run longitudinally. These fibres are processes—the *muscle processes*—(*C. m. pr.*) of the large ectoderm cells. Similar shorter muscle processes of some of the endoderm cells run circularly and antagonise the longitudinal fibres. Nematocysts are abundant in the ectoderm. The endoderm cells are mostly amœboid and vacuolated. Each usually bears one or more flagella, but these may be retracted. Glandular cells occur here and there. Nerve-cells (multipolar) occur in both layers, but present no regular arrangement. There is no perisarc. Buds (*bd. 1*, *bd. 2*) are produced which develop into Hydræ, but these are always detached sooner or later, so that a permanent colony is never formed. There are no special reproductive zooids, but simple ovaries (*ovy*) and testes (*spy*) are developed, the former at the proximal, the latter at the distal end of the body. Even simpler than *Hydra* are

Protohydra (Fig. 109) and *Microhydra*, in which the tentacles are absent.

Pelagohydra is also solitary, but is pelagic. The part corresponding to the base in *Hydra* here takes the form of a float, and there are tentacles distributed over the surface of the float as well as in the neighbourhood of the mouth; medusæ are developed from processes on the float. *Pelagohydra*, however, is perhaps more nearly related to the *Siphonophora*—an order yet to be dealt with—than to the *Leptolinæ*.

The **polypes** are usually cylindrical, as in *Obelia*, but in some genera they are widened out into a vase-like form (Fig. 106, δ), in others elongated into a spindle-shape (λ). The tentacles may be disposed in a single circlet, as in *Obelia* and *Hydra*, or there may be an additional circlet round the hypostome (β , δ), or at the base of the polype, or they may be scattered irregularly over the whole surface (λ). In *Myriothela* (γ) they are short, and so numerous as to have the appearance of close-set papillæ. In some forms they are knobbed at the ends, the knobs being loaded with stinging-capsules (λ).

In some species a *dimorphism* of the hydranths obtains, some of them being modified to form protective zooids. In *Hydractinia* (ι) these are simply mouthless hydranths with very short tentacles abundantly supplied with nematocysts, capable of very active movements, and called *dactylozooids* (dz). In *Plumularia* there are small structures called "guard-polypes," resembling tentacles in structure, with very numerous nematocysts, and each enclosed in a theca. In *Hydractinia* the cœnosarc is also produced into spines (sp), which may be much modified zooids.

But the most remarkable modifications occur in the **reproductive zooids**. In a large proportion of genera, both of *Anthomedusæ* and *Leptomedusæ*, these take the form of locomotive medusæ, agreeing in general structure with the descriptions already given. Each appears at first as a hollow bud-like process of the blastostyle, or of an ordinary polype, or, more exceptionally, of the cœnosarc. This becomes constricted at the junction and rounded off. The ectoderm at its free extremity becomes thickened, and this thickening, as it grows, pushes the endoderm before it, producing a sort of involution. In the interior of the mass of ectoderm a cavity appears: this is destined to form the sub-umbrellar cavity. The ectodermal partition that at first separates the cavity from the exterior becomes perforated and most of it is absorbed, what remains round the edge going to form the velum. The endoderm is reduced to a thin layer except along four radial lines where it gives rise to the four radial canals, the thin parts between going to form the endoderm lamella.

In different families and genera the medusæ exhibit almost endless variety in detail. As to size they vary from about 1 mm. in

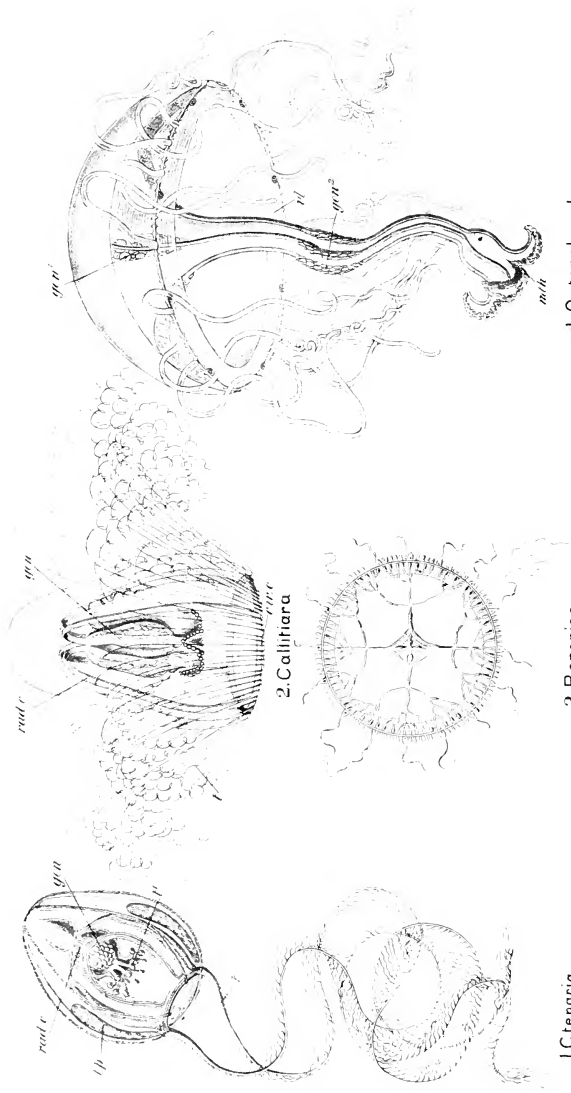

1. **Ctenaria**

3. **Berenia**

4. **Octorchandra**

FIG. 110. Various forms of **leptoline Medusa**. *c. c.*, circular canal; *gon. 1.*, *gon. 2.*, gonads; *rad. c.*, radial canal; *t.*, marginal tentacles; *M.*, oral tentacles; *t. p.*, tentacle-pouch; *cl.*, velum. (After Haeckel.)

diameter up to 400 mm. (16 inches). The number of marginal tentacles may be very great (Fig. 110, 2), or these organs may be reduced to two (Fig. 110, 1), or even to one (Fig. 106, 3); in the last-named cases it will be noticed that the medusa is no longer radially but bilaterally symmetrical, *i.e.* it can be divided into two equal and similar halves by a single plane only—*viz.*, the plane passing through the one or two tentacles. With the increase in the number of the tentacles a corresponding increase in that of the radial canals often takes place (Fig. 110, 3). In addition to the marginal tentacles longer or shorter *oral tentacles* may be present in a whorl surrounding the mouth (Fig. 110, 1').

Some medusæ creep over submarine surfaces, walking on the tips of their peculiarly modified tentacles (Fig. 106, 6), but the majority propel themselves through the water in a series of jerks by alternately contracting and expanding the umbrella, and so, by rhythmically driving out the contained water, moving with the apex foremost. In correspondence with these energetic movements there is a great development of both muscular and nervous systems. The velum and the sub-umbrella possess abundance of muscle-fibres, presenting a transverse striation, and round the margin of the umbrella is a double ring of nerve-cells and fibres, one ring being above, the other below the attachment of the velum (Fig. 102, *D, nv, nv'*). The medusæ thus furnish the first instance we have met with of a *central nervous system*, *i.e.* a concentration of nervous tissue over a limited area serving to control the movements of the whole organism. It has been proved experimentally that the medusa is paralysed by removal of the nerve-ring. Over the whole sub-umbrella is a loose network of nerve-cells and fibres connected with the nerve-ring, and forming a peripheral nervous system.

In some medusæ the circular canal communicates with the exterior by minute pores placed at the summits of papillæ, the endoderm cells of which contain brown granules. There seems to be little doubt that these are *organs of excretion*, the cells withdrawing nitrogenous waste-matters from the tissues and passing them out through the pores. If we except the contractile vacuoles of Protozoa, this is the first appearance of specialised excretory organs in the ascending series of animals.

Besides producing gonads, some medusæ multiply asexually by budding, the buds being developed either from the manubrium (Fig. 106, 7*a*), or from the margin of the umbrella (7*b*) or the base of the tentacles: in one case they are formed on blastostyles developed on the gonads. The buds always have the medusa form.

In many Leptolinæ the reproductive zooids undergo a degradation of structure, various stages of the process being found in different species. Almost every gradation is found, from perfect medusæ to ovoid pouch-like bodies called *sporosacs* (Fig. 106, 1*b*, 5, *s*),

each consisting of little more than a gonad, but showing an indication of its true nature in a prolongation of the digestive cavity of the colony, representing the stomach of the manubrium (Fig. 111). We thus have a reproductive *zooid* reduced to what is practically a reproductive *organ*. It is obvious that a continuation of the same process might result in the production of a simple gonad like that of *Hydra*: there is, however, no evidence to show that the Fresh-water Polype ever produced medusæ, and the probabilities are that its ovaries and testes are simply gonads, and not degenerate zooids. The case is interesting as showing how a simple structure may be imitated by the degradation of a complex one. It is quite possible, on the other hand, that the reproductive organs of the Leptomedusæ (Fig. 101) are sporosacs, *i.e.* reproductive zooids, not mere gonads. In some rare cases the sexual cells are not developed either in medusæ or in sporosacs,

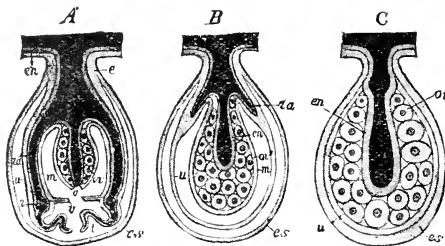

FIG. 111.—Diagram illustrating the formation of a sporosac by the degradation of a medusa. *A*, medusa enclosed in ectodermal envelope (*es*); *B*, intermediate condition with vestiges of umbrella (*u*) and radial canals (*ra*); *C*, sporosac. *ec*, ectoderm; *en*, endoderm; *m*, manubrium; *ov*, ovary; *t*, tentacle; *v*, velum. (From Lang's *Comparative Anatomy*.)

but are formed directly in the blastostyles.

In *Obelia* we found the medusæ to be budded off from peculiarly modified mouthless zooids—the blastostyles.

This arrangement, however, is by no means universal: the reproductive

zooids—whether medusæ or sporosacs—may spring directly from the cœnosarc, as in *Bougainvillea* (Fig. 105), or from the ordinary hydranths (Fig. 106, 4 and 5). The primitive sex-cells, from which ova or sperms are ultimately developed, are sometimes formed from the endoderm or (more usually) ectoderm cells of the reproductive zooid; but in many cases originate in the cœnosarc, and slowly migrate to their destination in the ectoderm of the gonad, where they metamorphose in the usual way into the definitive reproductive products, which when mature pass into the space below the ectoderm of the gonad.

The development of the Leptolinae frequently, but not always, begins within the maternal tissues, *i.e.* while the oosperm or impregnated egg-cell is still contained in the gonad of the medusæ or in the sporosac. The oosperm divides into two cells, then into four, eight, sixteen, &c. Fluid accumulates in the interior of the embryo, resulting in the formation of a blastula or hollow globe

formed of a single layer of cells (Fig. 112, *A*). The blastula elongates, and the cells at one pole undergo division, the daughter-cells passing into the cavity, which they gradually fill (*B*). At this stage the embryo is called a *planula*: it consists of an outer layer of cylindrical cells—the ectoderm—which acquire cilia, and an inner mass of polyhedral cells—the endoderm. In some cases the planula arises by a different process: a solid morula is formed, the superficial cells of which become radially elongated and form ectoderm, the central mass of cells giving rise to endoderm. By means of its cilia the planula swims freely, and before long a cavity appears in the middle of the solid mass of endoderm, the cells of which then arrange themselves in a single layer around the cavity or enteron (*C*, *al*). The planula then comes to rest, fixes itself at one end to some suitable support, and becomes con-

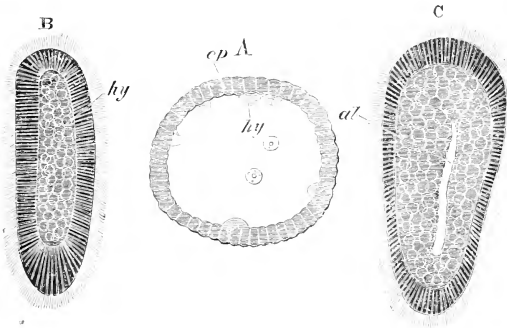

FIG. 112.—Early development of **Eucope**. *A*, blastula-stage; *B*, planula with solid endoderm; *C*, planula with enteric cavity; *al*, enteric cavity; *cp*, ectoderm; *hy*, endoderm. (From Balfour's *Embryology*, after Kowalevsky.)

verted into a simple polype or *hydrula* by the attached end broadening into a disc and the opposite extremity forming a manubrium and tentacles. The hydrula soon begins to send off lateral buds, and so produces the branched colony.

In Tubularia the oosperm develops, while still enclosed in the sporosac, into a short hydrula, which, after leading a free existence for a short time, fixes itself by its proximal end, buds, and produces the colony. In Hydra development begins in the ovary, and is complicated by the fact that the ectoderm of the morula gives rise to a sort of protective shell: in this condition the embryo is set free, and, after a period of rest, develops into the adult form.

ORDER 2.—TRACHYLINÆ.

General Structure.—The members of this order are all medusæ: no zoophyte stage is certainly known in any of them except *Cunina parasitica*, and several species have been proved to develop directly from the egg. They thus differ from the members of the preceding order in the fact that no alternation of generations ordinarily occurs in their life-history.

Most species are of small or moderate size, the largest not exceeding 100 mm. (4 inches) in diameter. The gelatinous tissue or mesoglea of the ex-umbrella is usually well developed, giving the medusa a more solid appearance than the delicate jelly-fish of

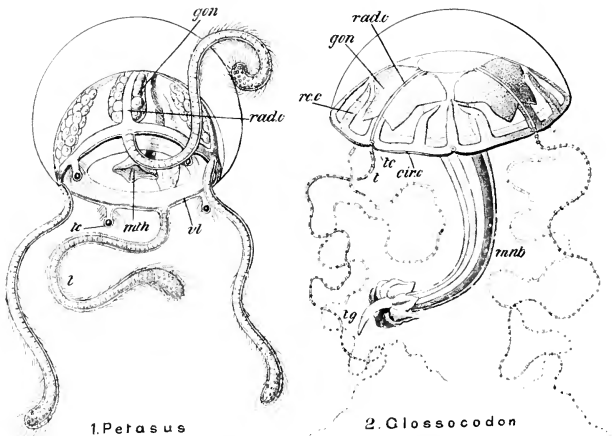

FIG. 113.—Two **Trachymedusæ**. *cir. c.* circular canal; *gon.* gonad; *mnh.* manubrium; *mth.* mouth; *rad. c.* radial canal; *rec. c.* recurrent canal; *t.* tentacle; *tc.* tentaculocyst; *ty.* tongue; *vl.* velum. (After Haeckel.)

the preceding order: this is well shown in Fig. 113, in which the apical region of the umbrella has a comparatively immense thickness. The tentacles are also stiff and strong, and are always solid in the young condition, although they may be replaced in the adult by hollow tentacles.

But the most characteristic anatomical feature of the group is the structure of the **sense-organs**, which are club-shaped bodies (Figs. 113 and 114, *tc*) consisting of an outer layer of ectoderm enclosing a central axis of endoderm cells (Fig. 115): they have, therefore, the structure of tentacles. They contain one or more lithites, which are always derived from the endoderm. To distinguish them from the lithocysts of *Leptomedusæ*, and to mark

the fact that they are modified tentacles, they are called *tentaculo-cysts*. They may either project freely from the margin of the umbrella, or may become enclosed in a pouch-like growth of

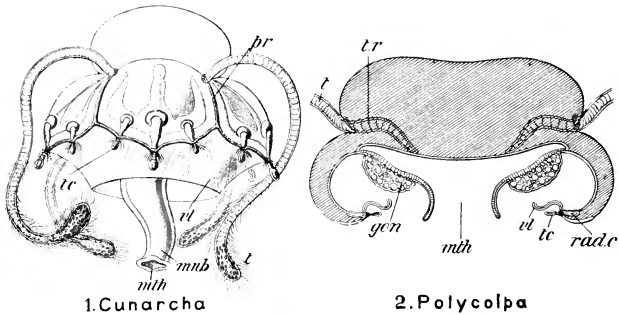

FIG. 114.—Two **Narcomedusæ**, 2 in vertical section. *gon*, gonad; *mnb*, manubrium; *mth*, mouth; *pr*, peronium; *rad. c.* radial canal; *t*, tentacle; *tc*, tentaculo-cyst; *tr*, tentacle-root; *vl*, velum. (After Haeckel.)

ectoderm and more or less sunk in the tissue of the umbrella. Eyes occur in some, and are always of simple structure.

The two sub-orders of Trachylinæ are characterised by the mode of origin of the **tentacles**. In Trachymedusæ, as in the preceding order, they arise near the edge of the umbrella (Fig. 113), but in the Narcomedusæ they spring about halfway between the edge and the vertex (Fig. 114), and are continued, at their proximal ends, into the jelly of the ex-umbrella in the form of “tentacle-roots” (*tr*).

As to the position of the **reproductive organs**, there is the same difference between the two sub-orders of Trachylinæ as between the two sub-orders of Leptolinæ. In the Trachymedusæ the gonads (Fig. 113, *gon*) are developed in the course of the radial canals: in the Narcomedusæ (Fig. 114) they lie on the manubrium, sometimes extending into the pouch-like offshoots of its cavity.

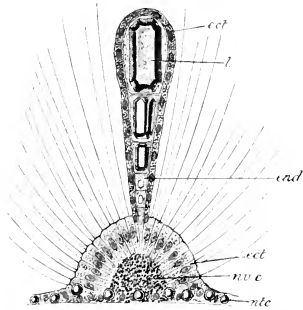

FIG. 115.—**Eginura myosura**, a tentaculo-cyst highly magnified. *ect*, ectoderm; *end*, endoderm; *l*, lithites; *ntc*, nematocysts; *nvc*, group of nerve-cells. (After Haeckel.)

There is always a well-developed velum, which, as in Fig. 114, *1*, may hang down vertically instead of taking the usual horizontal

position. In the Narcomedusæ the manubrium is short; in the Trachymedusæ it is always well developed, and is sometimes (Fig. 113, 2) prolonged into a long, highly contractile peduncle, having its inner surface produced into a tongue-like process (*tg*) which protrudes through the mouth. In some the gastric cavity is situated in the manubrium, which in such a case is looked upon as partly of the nature of a process of the sub-umbrella (*pseudomanubrium*).

The simplest case of the **development** of Trachylinæ is seen in *Æginopsis*, one of the Narcomedusæ. The oosperm gives rise to a ciliated planula, which forms first two (Fig. 116), then four tentacles, and a mouth, hypostome, and stomach. The larva of *Æginopsis* is thus a *hydrula*, closely resembling the corresponding stage of Tubularia. After a time the tentacular region grows out, carrying the tentacles with it, and becomes the umbrella of the medusa. Thus the actual formation of the medusa from the

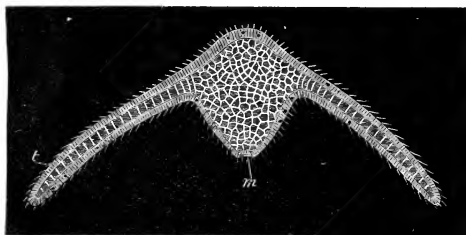

FIG. 116.—Larva of *Æginopsis*. *m*, mouth; *t*, tentacle.
(From Balfour, after Metschnikoff.)

hydrula of *Æginopsis* corresponds precisely with the theoretical derivation given above (p. 137). It will be seen that in the present case there is no metagenesis or alternation of

generations, but that development is accompanied by a *metamorphosis*—that is, the egg gives rise to a larval form differing in a striking manner from the adult, into which it becomes converted by a gradual series of changes.

Metagenesis is, however, not quite unknown among the Trachylinæ. In a parasitic Narcomedusa (*Cunina parasitica*) the planula fixes itself to the manubrium of one of the Trachymedusæ which serves as its host, and develops into a hydrula. But the latter, instead of itself becoming metamorphosed into a medusa, retains the polype form and produces other hydrulæ by budding, these last becoming converted into medusæ in the usual way.

ORDER 3.—HYDROCORALLINA.

The best-known genus of Hydroid Corals is *Millepora*, one species of which is the beautiful Elk-horn Coral, *M. alcicornis*. The dried colony (Fig. 117, *A*) consists of an irregular lobed or branched mass

of carbonate of lime (*corallum*), the whole surface beset with the numerous minute pores to which the genus owes its name. The pores are of two sizes: the larger are about 1 or 2 mm. apart, and are called *gastropores* (*B*, *g.p.*); the smaller are arranged more or less irregularly round the gastropores, and are called *dactylopores* (*d.p.*). The whole surface of the coral between the pores has a pitted appearance. Sections (*C*) show that the entire stony mass is traversed by a complex system of branched canals, which communicate with the exterior through the pores. The wide vertical canals in immediate connection with the pores are traversed by horizontal partitions, the *tabulæ* (*tb.*).

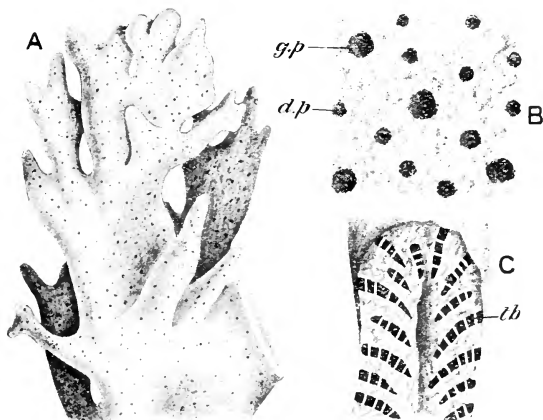

FIG. 117.—*Millepora alcicornis*. *A*, part of skeleton, natural size; *B*, portion of surface, magnified; *C*, vertical section, magnified; *d.p.* dactylopores; *g.p.* gastropores; *tb.* tabulæ. (After Nicholson and Lydekker.)

In the living animal each pore is the place of origin of a zooid: from the gastropores protrude polypes (Fig. 118, *G*) with hypostome and four knobbed tentacles; from the dactylopores long, filamentous, mouthless dactylozooids or feelers (*D*), with irregularly disposed tentacles: the function of these latter is probably protective and tactile, like that of the guard-polypes of Plumularia and the dactylozooids of Hydractinia. The bases of the zooids are connected with a system of delicate tubes, which ramify through the canals of the coral and represent a much-branched cœnosarc, recalling that of Hydractinia (p. 146).

The cœnosarc tubes have the usual structure, consisting of ectoderm and endoderm with an intervening mesogloea. From the relative position of the parts it will be obvious that the calcareous skeleton is in contact throughout with the ectoderm of the

colony: it is, in fact, like the horny perisarc of the Leptoliana, a cuticular product of the ectoderm.

The only other genus to which we shall refer is *Stylaster* (Fig. 119), which forms a remarkably elegant tree-like colony, abundantly branched in one plane, and of a deep pink colour. On the

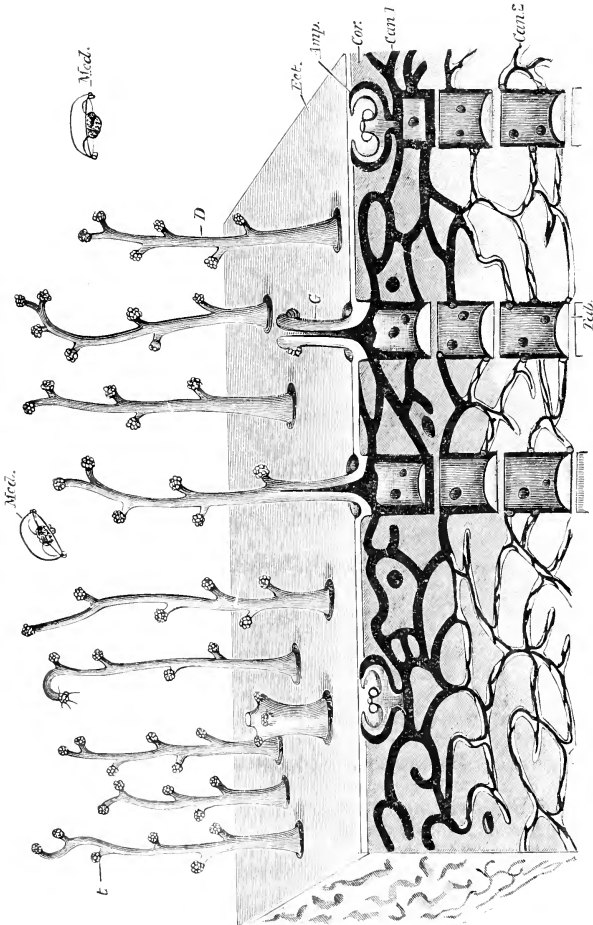

FIG. 118.—Diagrammatic sketch to show the structure of *Millepora*. *Amp.*, an ampulla containing a medusa; *Can. 1*, canal system at the surface; *Can. 2*, canal system degenerating in the lower layers of the corallum; *Cor.*, corallum; *D*, an expanded dactylozoid with its capitate tentacles; *Ect.*, the continuous sheet of ectoderm covering the corallum (*Cor.*); *G.*, a gastrozoid, seen in vertical section; *Med.*, free-swimming Medusae; *t*, tentacle; *Tab.*, tabula in the pore-tubes. (After Hickson.)

branches are little cup-like projections with radiating processes passing from the wall of the cup towards the centre, and thus closely resembling the true cup-corals belonging to the Actinozoa (*vide* p. 202). But in the case of *Stylaster* each "cup" is the locus, not of one, but of several zooids—a polype projecting from its centre, and a dactylozoid from each of the compartments of its peripheral portion. A calcareous projection, the *style*, the presence of which is the origin of the generic name, rises up from the tabula at the bottom of each cup.

The gonophores in most species of *Millepora* are developed in certain of the pores in dilatations or *ampullæ*; in one species at the apices of the dactylozooids.

They are medusæ, but never have the complete medusa-form, being devoid of velum, mouth, radial canals and tentacles. Both male and female medusæ become free, but the period of free existence is very short.

In *Stylaster* the medusoid character is much more completely lost, and the gonophores are more of the nature of sporosacs or degraded reproductive zooids lodged in special chambers (*a*) of the coral.

The *Hydrocorallina* occur only in the tropical portions of the Pacific and Indian Oceans, where they are found on the coral-reefs partly or entirely surrounding many of the islands in those seas. Fossil forms are found as far back as the Triassic epoch.

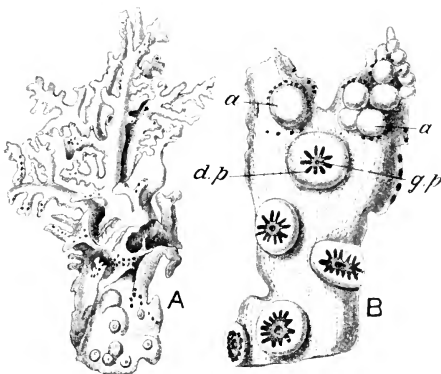

FIG. 119.—*Stylaster sanguineus*. A, portion of skeleton, natural size; B, small portion, magnified; *a*, ampullæ; *d.p.* dactylopores; *g.p.* gastropores. (After Nicholson and Lydekker.)

ORDER 4.—SIPHONOPHORA.

The diversity of form exhibited by the members of this order is so great that anything like a general account of it would only be confusing to the beginner, and the most satisfactory method of presentation will be by the study of a few typical genera.

Halistemma (Fig. 120, A) occurs in the Mediterranean and other

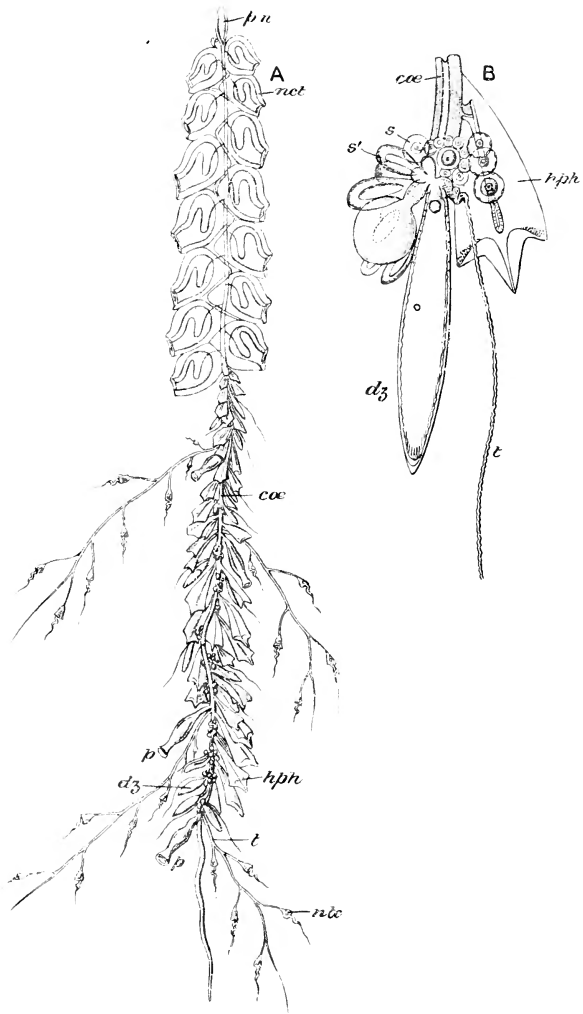

FIG. 120.—*Halistemma tergestinum*. *A*, the entire colony; *B*, a single group of zooid-
cae, canosare; *dz*, dactylozoid; *hph*, hydrophyllium or bract; *nct*, nectocalyx or swim-
 ming-bell; *nct*, battery of nematocysts; *p*, polype; *pn*, pneumatophore or float; *s*, *s'*,
 sporocysts; *t*, tentacle. (After Claus.)

seas, and consists of a long, slender, floating stem, to which a number of structures, differing greatly in form, are attached. At one—the uppermost—end of the stem is an ovoid, bubble-like body containing air—the *float* or *pneumatophore* (*pn*). Next come a number of closely set, transparent structures (*nct*), having the general characters of unsymmetrical medusæ without manubria, each being a deep, bell-like body, with a velum and radiating canals. During life these *swimming-bells* or *nectocalyces* contract rhythmically—*i.e.* at regular intervals—drawing water into their cavities, and immediately pumping it out, thus serving to propel the entire organism through the water. Below the last nectocalyx the character of the structures borne by the stem changes completely: they are of several kinds, and are arranged in groups which follow one another at regular intervals, and thus divide the stem into segments, like the nodes and internodes of a plant.

Springing from certain of the “nodes” are unmistakable polypes

(*p*), differing however from those we have hitherto met with in having no circlet of tentacles round the mouth, but a single long branched tentacle (*t*) arising from the proximal end, and bearing numerous groups or “batteries” of stinging-capsules (*ntc*). In

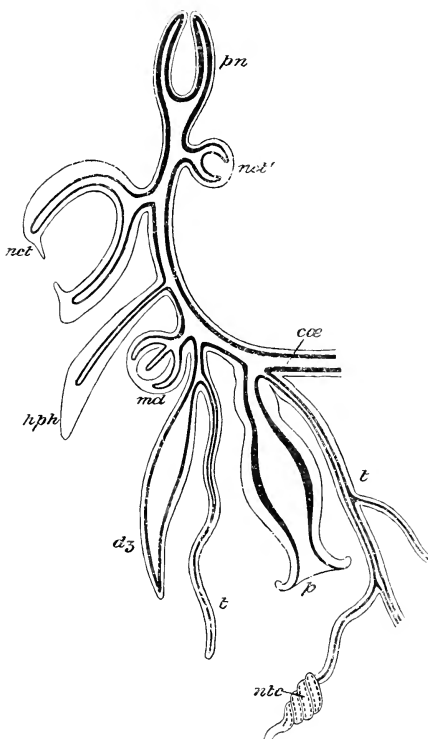

FIG. 121.—Diagram of a **Siphonophore**: the thick line represents endoderm; the space external to it, ectoderm; the internal space, the enteric cavity. *cœ*, coenosarc; *dz*, dactylozooid; *hph*, hydrophyllium; *md*, sporocyst; *nct*, *nct'*, nectocalyces; *ntc*, battery of nematocysts; *p*, polype; *pn*, pneumatophore; *t*, tentacle. (After Claus.)

the remaining nodes the place of the polypes is taken by dactylozooids or feelers (*dz*)—mouthless polypes, each with an unbranched tentacle springing from its base. Near the bases of the polypes and dactylozooids spring groups of sporosacs (*B*, *s*, *s'*), some male, others female; and finally delicate, leaf-like, transparent bodies—the *bracts* or *hydrophyllia* (*hph*)—spring from the “internodes” and partly cover the sporosacs.

It is obvious that on the analogy of such a hydroid polype as Obelia, Halistemma is to be looked upon as a polymorphic floating colony, the stem representing a cœnosarc, and the various structures attached to it zooids—the polypes nutritive zooids, the

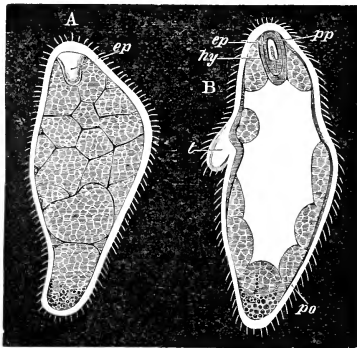

FIG. 122.—Two stages in the development of *Halistemma*: the endoderm is shaded, the ectoderm left white. *ep*, pneumatocyst or air-chamber of pneumatophore; *hy*, endoderm surrounding pneumatophore; *po*, polype; *pp*, pneumatophore; *t*, tentacle. (From Balfour, after Metschnikoff.)

feelers tactile zooids, the sporosacs reproductive zooids, the bracts protective zooids, and the swimming-bells locomotory zooids. The float may be looked upon as the dilated end of the stem, which has become invaginated or turned in so as to form a bladder filled with air, its outer and inner surfaces being furnished by ectoderm, and the middle portion of its wall by two layers of endoderm, between which the enteric cavity originally extended (Fig. 121, *pn*). The upper or float-bearing end is proximal—*i.e.* answers to the attached end of an Obelia-stem: it is the opposite or distal end which grows and forms new zooids by budding.

In some Siphonophora the bracts contain indications of radial canals, so that these structures, as well as the swimming-bells and sporosacs, are formed on the medusa-type, while the hydranths and feelers are constructed on the polype-type.

It will be noticed that the radial symmetry, so characteristic of most of the Hydrozoa previously studied, gives way, in the case of *Halistemma*, to a bilateral symmetry. The swimming-bells are placed obliquely, and the mouth of the bell is not at right angles to the long axis, so that only one plane can be taken dividing these structures into two equal halves: the same applies to the polype and feelers with their single basal tentacle. When first formed the various zooids are all on one side of the stem, but

the latter becomes spirally twisted during growth, and so causes them to arise irregularly.

The egg of *Halistemma* gives rise to a ciliated planula resembling that of the other Hydrozoa. At one pole the ectoderm becomes invaginated to form the float (Fig. 122, *ep*), the opposite extremity is gradually converted into the first polype (*po*), and a bud appears on one side which becomes the first tentacle (*t*). By gradual elongation, and the formation of new zooids as lateral buds, the adult form is produced; the various zooids are all formed between the first polype and the float, so that the two become further and further apart, being always situated at the distal and proximal ends of the colony respectively.

In an allied form (*Agalma*) the first structure to appear in the embryo is not the float, but the first bract, which grows considerably and envelops the growing embryo in much the same way as the umbrella of a medusa envelops the manubrium. On this and other grounds some zoologists look upon the Siphonophore-colony as a medusa the manubrium of which has extended immensely and produced lateral buds after the manner of some Anthomedusæ (Fig. 106, 7 *a*). On this theory the entire cœnosarc is an extended manubrium and the first or primary bract is the umbrella. But frequently—as in *Halistemma*—a primary bract is not formed, and when present there appears to be no reason against regarding it as a lateral bud of the axis, of quite the same nature as the remaining zooids.

In the well-known "Portuguese man-of-war" (*Physalia*) there is a great increase in proportional size of the float and a corre-

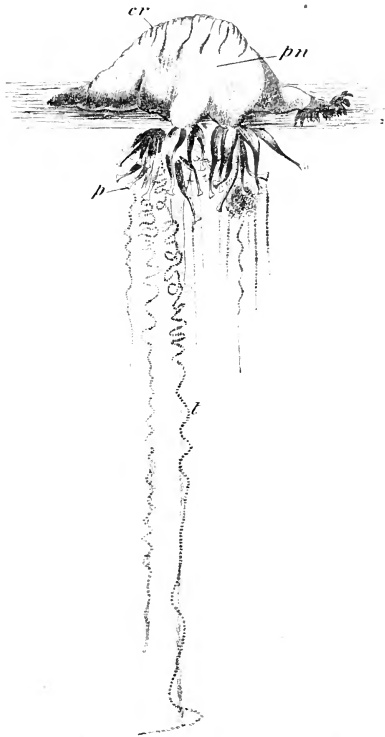

FIG. 123.—*Physalia*: the living animal floating on the surface of the sea. *cr*, crest; *p*, polype; *pn*, pneumatophore; *t*, tentacle. (After Huxley.)

sponding reduction of the rest of the cœnosarc. The float (Fig. 123, *pn*) has the form of an elongated bladder, from 3 to 12 cm. long, pointed at both ends, and produced along its upper edge into a crest or sail (*cr*): as a rule it is of a brilliant peacock-blue colour, but orange-coloured specimens are sometimes met with.

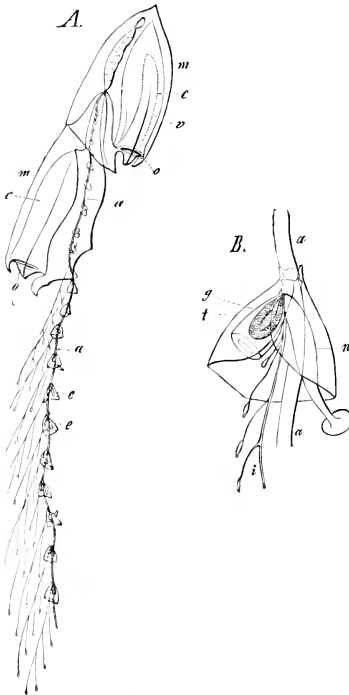

FIG. 124.—*Diphyes campanulata*. *A*, the entire colony; *B*, single group of zooids. *a*, cœnosarc; *c*, cavity of swimming-bell; *e*, groups of zooids; *g*, medusoid; *i*, grappling-line or tentacle; *m*, swimming-bell; *n*, polype; *o*, mouth of swimming-bell; *t*, bract. (From Parker's *Biology*, after Gegenbaur.)

At one end is a minute aperture communicating with the exterior. There are no swimming-bells, but from the underside of the float hang gastrozooids (*p*), dactylozooids, branching blastostyles (*gonodendra*) with groups of medusoids looking like bunches of grapes of a deep blue colour, and long retractile tentacles (*t*), sometimes several feet in length and containing batteries of stinging-capsules powerful enough to sting the hand as severely as a nettle. The male reproductive zooid remains attached, as in *Halistemma*, but the female apparently becomes detached as a free medusa.

In *Diphyes* the float is absent. Two swimming-bells (Fig. 124, *A*, *m*) of proportionally immense size are situated at the proximal end of the cœnosarc, and are followed by widely-separated groups of zooids (*B*), each group containing a polype (*n*) with its tentacles (*i*), a meduzoid (*g*), and a large enveloping bract (*t*). The stem often breaks at the internodes,

and the detached groups of zooids then swim about like independent organisms.

Porpita is formed on a different type, and has a close general resemblance to a medusa. It consists (Fig. 125) of a discoid body, enclosing a chambered chitinous shell (*sh*) containing air, and

obviously corresponding with the float of *Physalia*: each of the chambers communicates with the exterior by a couple of pores. The edge of the disc is beset with long dactylozooids (*t*), and from its lower surface depend numerous closely set blastostyles provided with mouths and bearing medusæ, while in the centre is a single large gastrozoid (*hy*). The mouth of the gastrozoid leads into a wide gastric cavity. Between this and the pneumatophore is a thick cellular mass through which ramify numerous canals belonging to two systems. One of these systems is endodermal: it communicates with the endodermal cavities throughout the colony.

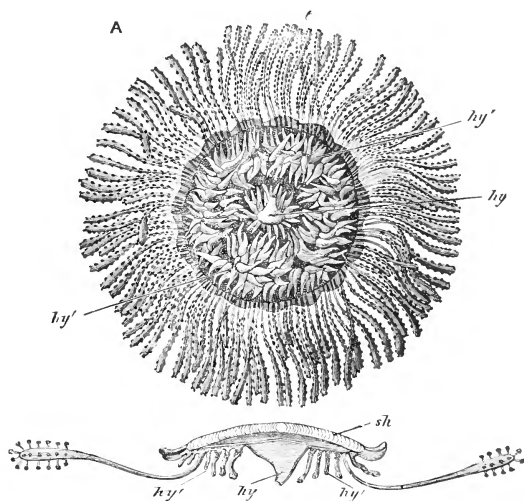

FIG. 125.—*Porpita pacifica*. *A*, from beneath; *B*, vertical section. *hy*, large central gastrozoid; *hy'*, blastostyles; *sh*, chambered shell; *t*, dactylozooids. (From Parker's *Biology*, after Duperry and Koelliker.)

The other (*tracheal system*) is ectodermal and is lined internally throughout by a chitinous layer; it opens by numerous apertures into the air-chambers of the float. The closely allied genus *Velella* is of rhomboidal form, and bears on its upper surface an oblique sail.

The reproductive zooids are liberated as free medusæ. The eggs give rise to young which have a close resemblance to flat medusæ with manubrium, marginal tentacles, and an air-chamber or float developed in the ex-umbrella. Thus it is quite possible that the Siphonophora of the *Porpita*-type may be medusæ the sub-umbrella of which has given rise to buds forming the feelers and blastostyles. But, as their early development is not known, it

is still quite legitimate to describe them in the same terms as the other Siphonophora—*i.e.* to consider them as hydroid colonies in which the cœnosarc is represented by the discoid or rhomboid body with its contained air-chamber.

ORDER 5.—GRAPTOLITHIDA.

The "Graptolites" are fossil Hydrozoa found in the Upper Cambrian and Silurian rocks. They are known only by their fossilised chitinous skeleton, all trace of the soft parts having, as in the majority of fossils, disappeared.

With one doubtful exception they are compound, consisting of an elongated tube—the perisarc of the common stem, having attached to it, either in a single or a double row, numerous small projections, the hydrothecæ (Fig. 126, *h.th.*).

The cœnosarc skeleton is strengthened by a slender axis, the *virgula* (*v.*), the proximal end of which is connected with a small dagger-shaped body, the *sicula* (*s.*), supposed to be the skeleton of the primary zooid by the budding of which the colony was produced. In connection with some species oval or cup-like capsules have been found: these may be of the nature of gonothecæ. But it must be added that the evidence in favour of associating the Graptolites with the Hydrozoa is by no means conclusive, and reasons have been adduced for regarding them as connected with groups much higher in the scale.

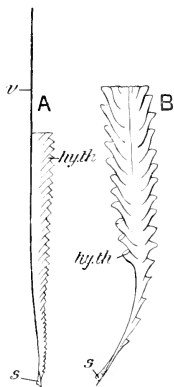

FIG. 126.—Graptolites. A, *Monograptus colonus*; B, *Dimorphograptus*, both magnified. *h. th.* hydrotheca; *s.* sicula; *v.* virgula. (After Nicholson and Lydekker.)

ADDITIONAL REMARKS ON THE HYDROZOA.

The vast majority of Hydrozoa are marine, the only exceptions being *Hydra*, found all over the world; *Microhydra*, at present known only in North America; *Cordylophora*, one of the Anthomedusæ, found in Europe, America, Australia, and New Zealand; *Polypodium*, also an Anthomedusa, found in the Volga, where in one stage of its existence it is parasitic on the eggs of the Sturgeon; *Limnocodium*, a doubtful Trachymedusa, hitherto found only in a tank in the Botanical Gardens, Regent's Park, where it was probably introduced from the West Indies; and *Limnocnida*, found in Lakes Tanganyika and Victoria Nyanza and in the river Niger.

The oldest known Hydrozoa are the Graptolites, found first in the Cambrian rocks; *Hydractinia* occurs in the Cretaceous epoch, and Hydrocorallinæ from the Cretaceous onwards.

Parasitism, although rare, is not unknown in the class. *Polypodium*, one of the Anthomedusæ, is parasitic during part of its existence, in the ovary of the Sturgeon; and *Cuinia*, one of the Narcomedusæ, is parasitic on a Trachymedusa.

In the section on the Protozoa we saw that while the majority

of species are independent cells, each performing alone all the essential functions of an animal, others, such as *Pandorina*, *Volvox*, and *Proterospongia*, consist of numerous unicellular zooids associated to form a colony in which a certain division of labour obtains, the function of reproduction, for instance, being assigned to certain definite cells and not performed by all alike. Thus the colonial Protozoa furnish an example of *individuation*, numerous cells combining to form a colony in which the several parts are dependent one upon another, and which may therefore be said to constitute, from the physiological point of view, an individual of a higher order than the cell.

This is still more notably the case in the lower Metazoa, such as *Ascetta* and *Hydra*, in which we have numerous cells combined to form a permanent two-layered sac with a terminal aperture, some of the cells having digestive, others tactile, others reproductive functions. Thus while an *Amœba* or a *Paramœcium* is an *individual of the first order*, *Hydra* and *Ascetta* are *individuals of the second order*, each the equivalent of an indefinite number of individuals of the first order.

In the Hydrozoa we see this process carried a step further. Budding takes place and colonies are produced, the various zooids of which,—each the equivalent of a *Hydra*,—instead of remaining all alike, become differentiated both morphologically and physiologically, so as to differ immensely from one another both in form and function. In *Obelia*, for instance, reproduction is made over exclusively to the medusæ, while in *Halistemma* we have zooids specially set apart, not only for reproductive but for tactile and protective purposes. Thus in *Halistemma* and the other Siphonophora there is a very complete subordination of the individual zooids to the purposes of the colony as a whole, the colony thus assuming, from the physiological point of view, the characteristics of a single individual, and its zooids the character of organs. In this way we get an *individual of the third order*, consisting of an aggregate of polymorphic zooids, just as the zooid or individual of the second order is an aggregate of polymorphic cells or individuals of the first order.

CLASS II.—SCYPHOZOA.

1. EXAMPLE OF THE CLASS—THE COMMON JELLY-FISH (*Aurelia aurita*).

Aurelia is the commonest of the larger jelly-fishes, and is often found cast up on the sea-shore, when it is readily recognisable by its gelatinous, saucer-shaped umbrella, three or four inches in diameter, and by having near the centre four red or purple horse-shoe-shaped bodies—the gonads—lying embedded in the jelly.

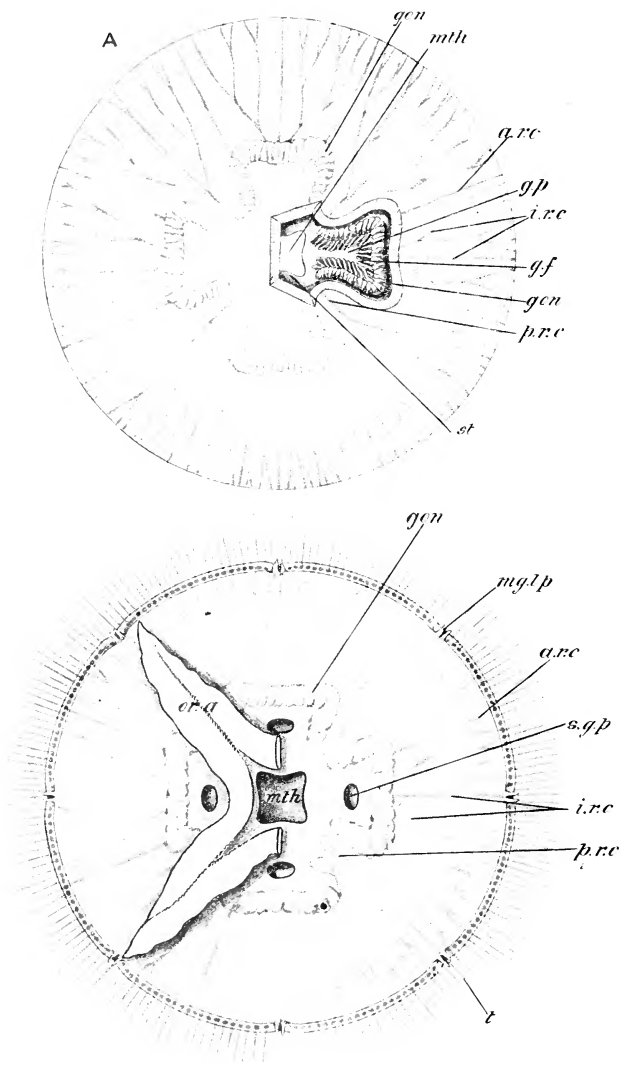

FIG. 127.—*Aurelia aurita*. *A*, dorsal view, part of the ex-umbrella cut away to show part of the stomach and one of the four gastric pouches; *B*, ventral view—two of the oral arms are removed. *a.r.c.* ad-radial canal; *g.f.* gastric filaments; *gon.* gonads; *g.p.* gastric pouch; *i.r.c.* inter-radial canal; *m.g.l.p.* marginal lappet; *mth.* mouth; *or.a.* oral arm; *p.r.c.* per-radial canal; *s.g.p.* sub-genital pit; *st.* stomach; *t.* tentacles.

External Characteristics.—The general arrangement of the parts of the body is very similar to what we are already familiar with in the hydrozoan jelly-fishes. Most conspicuous is the concavo-convex *umbrella*, the convex surface of which, or ex-umbrella, is uppermost in the ordinary swimming position (Figs. 127 and 128, *A*). The outline is approximately circular, but is broken by eight notches, in each of which lies a pair of delicate processes, the *marginal lappets* (*mg. lp*): between the pairs of lappets the edge of the umbrella is fringed by numerous close-set *marginal tentacles* (*t*).

A narrow region of the umbrella adjoining the edge is very thin and flexible: the structure thus constituted, with its marginal notches and the fringe of marginal tentacles, is the *velarium*. Unlike the true velum of the medusæ of the Hydrozoa the velarium contains endodermal canals.

In the centre of the lower or sub-umbrellar surface is a four-sided aperture, the *mouth* (*mt*), borne at the end of an extremely short and inconspicuous *manubrium*: surrounding it are four long delicate processes, the *oral arms* (*or. a*), lying one at each angle of the mouth and uniting around it. Each arm consists of a folded membrane, tapering to a point at its distal end, beset along its edges with minute lobules, and abundantly provided with stinging-capsules. The angles of the mouth and the arms lie in the four per-radii, *i.e.* at the end of the two principal axes of the radially symmetrical body: of the marginal notches with their lappets, four are per-radial and four inter-radial.

At a short distance from each of the straight sides of the mouth, and therefore inter-radial in position, is a nearly circular aperture leading into a shallow pouch, the *sub-genital pit* (*s.g.p*), which lies immediately beneath one of the conspicuously coloured gonads (*gon*). The sub-genital pits have no connection with the reproductive system, and are probably respiratory in function.

Digestive Cavity and Canal-System.—The mouth leads by a short tube or *gullet* (*gul*), contained in the manubrium, into a spacious *stomach* (*st*), which occupies the whole middle region of the umbrella, and is produced into four wide inter-radial *gastric pouches* (*g.p*), which extend about halfway from the centre to the circumference, and are separated from one another by thick pillar-like portions of the umbrella-jelly. In the outer or peripheral wall of each gastric pouch are three small apertures, leading into as many *radial canals*, which pass to the edge of the umbrella and there unite in a very narrow *circular canal* (*circ. c*). The canal, which opens by the middle of the three holes, is of course inter-radial (*i.r.c*): it divides immediately into three, and each division branches again: the canals from the other two holes are ad-radial (*a.r.c*), and pass to the circular canal without branching. There is also an aperture in the re-entering

angle between each two gastric pouches: this leads into a per-radial canal (*p.r.c.*), which, like the inter-radial, branches extensively on its way to the edge of the umbrella.

The general arrangement of the cell-layers in Aurelia is the same as in a hydroid medusa (Fig. 128, *B*). The main mass of the umbrella is formed of gelatinous mesogloea, which, however, is not structureless, but is traversed by branching fibres and

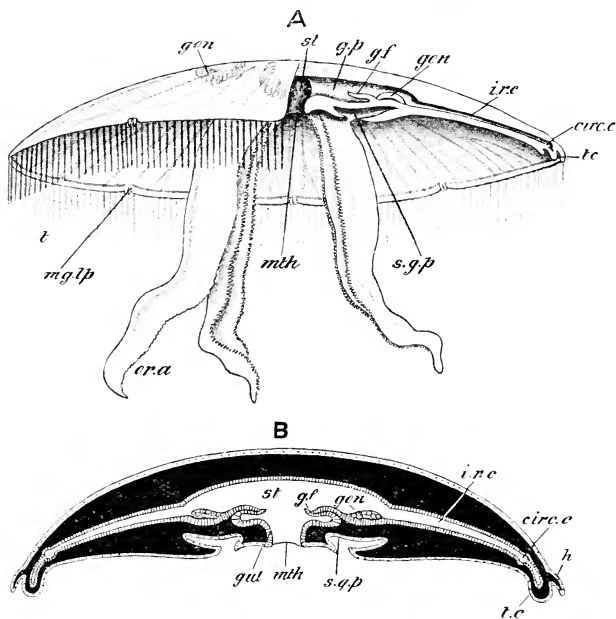

FIG. 128.—*Aurelia aurita*. *A*, side view, one-fourth of the umbrella cut away; *B*, diagrammatic vertical section, ectoderm dotted, endoderm striated, mesogloea black. *circ. c.* circular canal; *g. f.* gastric filaments; *gon.* gonad; *g. p.* gastric pouch; *gul.* gullet; *h.* hood; *i. r. c.* inter-radial canal; *mg. lp.* marginal lappet; *mth.* mouth; *or. a.* oral arm; *s. g. p.* sub-genital pit; *st.* stomach.

contains amœboid cells derived from the endoderm. Both ex- and sub-umbrellæ are covered with ectoderm, and the stomach and canal system are lined with endoderm, which is ciliated throughout. Some observations seem to show that the short tube described above as a gullet and a part of the gastric pouches are lined, not by endoderm, but by an in-turned portion of the ectoderm, but this matter cannot be considered as definitely settled.

It was mentioned above that in the free medusa the gonads appear through the transparent umbrella as coloured horse-shoe-shaped patches. Their precise position is seen by cutting away a portion of the ex-umbrella so as to expose one of the gastric pouches from above (Fig. 127, *A*). It is then seen that the gonad (*gon*) is a frill-like structure lying on the floor of the pouch and bent in the form of a horse-shoe with its concavity looking inwards, *i.e.* towards the mouth. Being developed from the floor of the enteric cavity, the gonad is obviously an endodermal structure: when mature, its products—ova or sperms—are discharged into the stomach and pass out by the mouth. Here, then, is an important difference from the Hydrozoa, in which the generative products are usually located in the ectoderm, and are always discharged directly on the exterior. The sexes are lodged in distinct individuals.

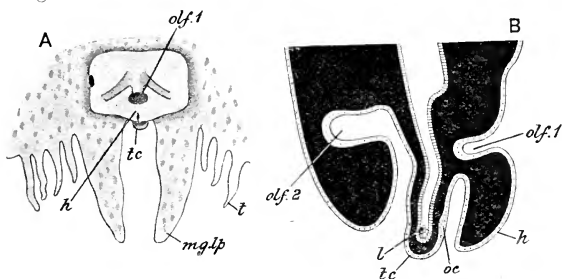

FIG. 129.—*Aurelia aurita*. *A*, small portion of edge of umbrella, showing the relations of the tentaculocyst; *B*, vertical section of the same region (diagrammatic). *h*, hood; *l*, lithite; *mg. lp.*, marginal lappet; *oc*, ocellus; *olf. 1*, *olf. 2*, olfactory pits. (Altered from Lankester.)

Lying parallel with the inner or concave border of each gonad is a row of delicate filaments (Figs. 127, 128, *g.f.*), formed of endoderm with a core of mesogloea and abundantly supplied with stinging-capsules. These are the **gastric filaments** or **phacellæ**: their function is to kill or paralyse the prey taken alive into the stomach. No such endodermal tentacles are known in the Hydrozoa.

Muscular and Nervous Systems.—The contractions of the bell by which the animal is propelled through the water are effected by means of a muscular zone round the edge of the sub-umbrella. The nervous system is formed on a different plan from that of the hydroid medusæ. Extending over the sub-umbrellar surface between the superficial epithelial layer of ectoderm and the muscular layer is a plexus of simple nerve-fibres. This presents radial thickenings, most strongly developed externally in the per-radii and inter-radii, corresponding to the

position of the marginal notches and sense-organs. About the base of each of the latter are special groups of nerve-cells. A slight ring-like thickening of the plexus extends round the margin in the neighbourhood of the marginal canal.

The **sense organs** (Fig. 129) are lodged in the marginal notches in close relation with the nerve-patches: like the latter, therefore, four of them are per-radial and four inter-radial. Each consists of a peculiar form of sense-club or *tentaculocyst*, containing a prolongation of the circular canal, and thus representing a hollow instead of a solid tentacle. At the extremity are calcareous concretions or *lithites* (*l*) derived from the endoderm, and on the outer side is an ectodermal pigment-spot or *ocellus* (*oc*). The tentaculocysts are largely hidden by the marginal lappets (*mg. lp*) and by a hood-like process (*h*) connecting them; and in connection with each are two depressions, one on the ex-umbrella (*olf. 1*), the other immediately internal to the sense-club (*olf. 2*): these depressions are lined with sensory epithelium and are called *olfactory pits*.

The **development and life-history** of Aurelia present several striking and characteristic features. The impregnated egg-cell or oosperm divides regularly and forms a morula, which, by accumulation of fluid in its interior, becomes a blastula—a closed sac with walls formed of a single layer of cells. One end of this sac becomes invaginated to form the gastrula. The blastopore or gastrula-mouth does not completely close, the resulting two layered *planula* (Fig. 130) differing in this respect, as well as in its mode of formation, from the corresponding stage of a Hydrozoon.

The planula swims about by means of the cilia with which its ectodermal cells are provided, and, after a brief free existence, settles down, loses its cilia, and becomes attached by one pole. At the opposite pole a mouth is formed; if, as represented in Figs. *B* and *C*, the process takes place by a sinking-in or invagination of the surface so as to produce a depression lined with ectoderm (*B, st*), the bottom of which becomes perforated so as to communicate with the enteric cavity (*C, st*). the depression is the *stomodæum*, a structure of which there is no trace in the Hydrozoa: there is some doubt, however, of the occurrence of any such ectodermal involution in the case of Aurelia. On two opposite sides of the mouth hollow processes grow out, forming the first two tentacles: soon two others appear at right angles to these, the organism thus being provided with four per-radial tentacles. Subsequently four inter-radial and eight ad-radial tentacles appear. At the same time the attached or proximal end is narrowed into a stalk-like organ of attachment (*E*), and the endoderm of the enteric cavity is produced into four longitudinal ridges, inter-radial in position, and distinguished as the *gastric ridges* or *tanioles* (*D, tn.*). The mouth (*E, mth.*) assumes a square outline, and its edges become raised so as to form a short

manubrium (*mnb.*); and, finally, the ectoderm of the distal surface—*i.e.* the region lying between the mouth and the circlet of tentacles—becomes invaginated in each inter-radius so as to produce four

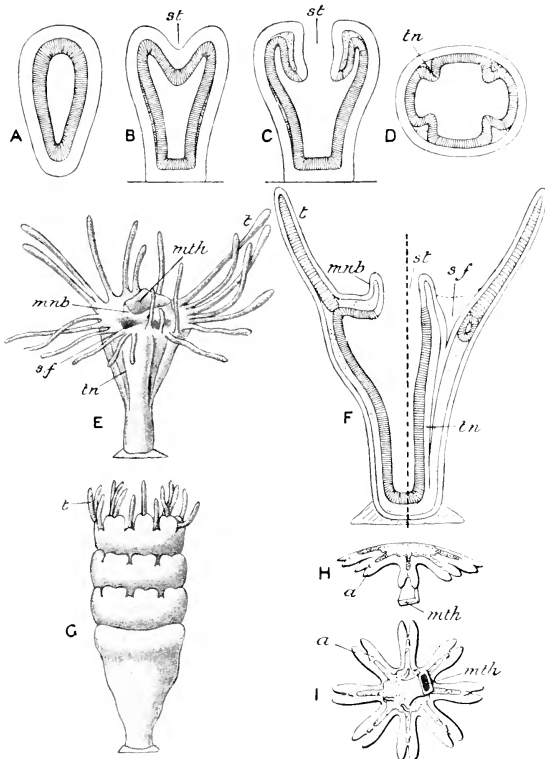

FIG. 130.—*Aurelia aurita*, development. *A*, planula, erroneously represented as completely closed; *B*, *C*, formation of stomodæum; *D*, transverse section of young scyphula; *E*, scyphula; *F*, longitudinal section of same: the section passes through a per-radius on the left of the dotted line, through an inter-radius on the right; *G*, division of scyphula into ephyrae; *H*, ephyra from the side; *I*, the same from beneath. In *A*—*D* and *F* the ectoderm is unshaded, the endoderm striated, and the mesogloea dotted. *a*, lobes of umbrella; *mnb.* manubrium; *mth.* mouth; *s. f.* septal funnel; *st.* stomodæum; *t.* tentacle; *tn.* tænioles. (From Korschelt and Heider's *Embryology*.)

narrow funnel-like depressions—the *septal funnels* or *infundibula* (*E* and *F*, *s. f.*)—sunk in the four gastric ridges.

The outcome of all these changes is the metamorphosis of the planula into a polype (*E*), not unlike a Hydra or the hydrula-stage

of the Leptolinæ, but distinguished by a pronounced differentiation of structure, indicated by the sixteen tentacles developed in regular order, the stomodæum, and the four gastric ridges with their septal funnels. The Scyphozoon-polype is called a *scyphula* or *scyphistoma*.

The scyphula may grow to a height of half an inch, and sometimes multiplies by budding. After a time it undergoes a process of transverse fission (*G*), becoming divided by a series of constrictions which deepen until the polype assumes the appearance of a pile of saucers, each with its edge produced into eight bifid lobes, four per- and four inter-radial. Soon the process of constriction is completed, the saucer-like bodies separate from one another, and each, turning upside down, begins to swim about as a small jelly-fish called an *ephyrula* (*H*, *I*). The umbrella of the ephyrula is divided into eight long bifid arms (*a*) with deep (per-radial or inter-radial) notches: it has of course carried away with it a segment of the stomach with the gastric ridges of the scyphula: during the process of constriction this becomes closed in on the proximal or ex-umbrellar side, while on the sub-umbrellar side it remains open, and its edges grow out to form a manubrium. Round the margin there are the bases of eight per-radial and inter-radial tentacles, each in the notch of one of the arms, and eight ad-radial tentacles in the intervals between the lobes: the latter disappear completely; the former may persist as the tentaculocysts. On each gastric ridge appears a single gastric filament, soon to be followed by others, and in the notches at the extremities of the eight arms tentaculocysts are now recognisable. In the meantime the spacious enteric cavity is continued into the eight arms in the form of wide radiating canals.

As the ephyrula grows the ad-radial regions—at first deeply notched—grow more rapidly than the rest, the result being that the notches become gradually filled up, and the umbrella, from an eight-rayed star, becomes a nearly circular disc. Four oral arms are developed and numerous marginal tentacles, and the ephyrula gradually assumes the form of the adult Aurelia. It seems probable that the sub-genital pits of the medusa are formed from sections of the septal funnels of the scyphula.

Thus the life-history of Aurelia differs in several marked respects from that of any of the Hydrozoa. There is, in a sense, an alternation of generations as in Obelia, the gamobium being represented by the adult Aurelia, the agamobium by the scyphula. But instead of the medusa being developed either as a bud on a branched colony, as in Leptolinæ, or by direct metamorphosis of a polype, as in Trachylinæ, it is formed by the metamorphosis of an ephyrula developed as one of several transverse segments of a polype; so that the life-history might be described as a metamorphosis complicated by multiplication in the larval (scyphula) condition, rather than a true alternation of generations.

It has been shown that, under exceptional circumstances, the egg of *Aurelia* develops into scyphulæ which do not undergo transverse division, the entire scyphula becoming metamorphosed into a single adult.

2. GENERAL STRUCTURE AND CLASSIFICATION.

The Scyphozoa may be defined as medusoid Cœlenterata, having the same general structure and arrangement of the layers as the medusoid Hydrozoa, but differing from them in the possession of endodermal gastric tentacles; in having gonads the sexual cells of which are lodged in the endoderm and which discharge their products into the digestive cavity; in the absence of a true velum, and, in nearly all cases, in the presence of sense-organs in the form of hollow sense-clubs or tentaculocysts. Whether a stomodæum or ectodermal gullet occurs is uncertain. As in the Hydrozoa, the medusa develops directly from the egg in some Scyphozoa, while in others there is a sort of alternation of generations, a polype-form (agamobium) giving rise to the medusa-form (gamobium) by a process of transverse fission. In the majority, however, nothing is known of the life-history, the process of development having been worked out only in a few cases.

As far as is known, the segmenting embryo gives rise to a gastrula by invagination in all with the exception of *Lucernaria* and its allies: by the partial or complete closure of the blastopore a planula is produced, at one end of which a second invagination takes place, forming the stomodæum.

The Scyphozoa are divisible into four orders, as follows:—

ORDER 1.—STAUROMEDUSÆ (LUCERNARIDA).

Scyphozoa having a conical or vase-shaped umbrella, sometimes attached to external objects by an ex-umbrellar peduncle: no tentaculocysts.

ORDER 2.—CORONATA.

Scyphozoa having the umbrella divided by a horizontal *coronary groove*: four to sixteen tentaculocysts.

ORDER 3.—CUBOMEDUSÆ.

Scyphozoa with a four-sided cup-shaped umbrella: four per-radial tentaculocysts.

ORDER 4.—DISCOMEDUSÆ.

Scyphozoa with a flattened saucer- or disc-shaped umbrella: not fewer than eight tentaculocysts—four per- and four inter-radial.

Sub-Order a—Semostomæ.

Discomedusæ in which the square mouth is produced into four long oral arms.

Sub-Order b—Rhizostomæ.

Discomedusæ having the mouth obliterated by the growth across it of the oral arms: the stomach is continued into canals which open by funnel-shaped apertures on the edges of the arms.

Systematic Position of the Example.

Aurelia aurita is one of several species of the genus *Aurelia*, and is placed in the family *Ulmaridæ*, the sub-order *Semostomæ*, and the order *Discomedusæ*.

Its saucer-shaped umbrella and eight tentaculocysts place it at once among the Discomedusæ: the presence of a distinct mouth surrounded by four oral arms places it in the first sub-order or Semostomæ. This group contains six families, characterised mainly by differences in the canal system: the Ulmaridæ are distinguished by narrow branched radial canals opening into a circular canal. Of the eight genera in this family, *Aurelia* stands alone in having its tentacles attached on the dorsal or ex-umbrellar side of the margin, and in the oral arms showing no trace of bifurcation. Eight species of *Aurelia* are recognised, *A. aurita* being distinguished by having the oral arms slightly shorter than the radius of the umbrella, and by possessing a trichotomous inter-radial canal and two unbranched ad-radial canals springing from each gastric pouch.

ORDER 1.—STAUROMEDUSÆ (LUCERNARIDA).

Tessera (Fig. 131), formerly regarded as the simplest member of this group, is now looked upon as probably not a mature form. It is described as a small medusa about 4 mm. in diameter having the same general characters as the scyphula-stage of *Aurelia*, except that the bell-shaped body is free-swimming. The edge of the umbrella is surrounded by eight tentacles, four per-radial (*p.r.t.*) and four inter-radial (*i.r.t.*), and movement is effected by a well-developed system of circular and radial muscles.

Lucernaria (Fig. 132), a genus not uncommon on the British coasts, is in one respect even more like a scyphula, since it is attached by a peduncle developed from the centre of the ex-umbrella. The margin of the umbrella is prolonged into eight short hollow ad-radial arms, bearing at their ends groups of short adhesive tentacles (*t.*). As in the scyphula, each gastric ridge contains an infundibulum, lined with ectoderm and opening on the sub-umbrella. The gastric filaments (*g.f.*) are very numerous—a distinct advance on *Tessera*—and the gonads (*gon.*) are band-like. There are no sense-organs in *Lucernaria*, but in an allied genus, *Halicystus*, there are eight per-radial and inter-radial marginal bodies (*anchors*) of the nature of reduced and modified tentacles, each surrounded at its base by a cushion-like thickening containing many adhesive cells. Internal to each anchor on the sub-umbrellar side is a pigment spot (rudimentary eye). *Stenocyphus* is an allied form which probably is able to move by ereeping (looping) movements like those of a leech. *Capria* has no tentacles. The *Depastridæ* have an almost entire margin fringed with tentacles.

ORDER 2.—CORONATA.

This group includes a number of rare and beautiful Medusæ of curiously complex structure, of which *Pericolpa* may be taken as an example. The umbrella (Fig. 133) is usually conical, and is divided by a horizontal furrow

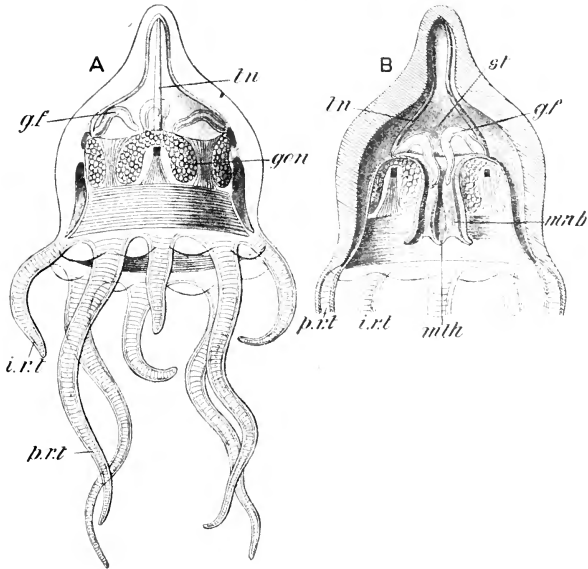

FIG. 131.—*Tessera princeps*. A, external view; B, vertical section. *gf*, gastric filament; *gon*, gonad; *i.r.t.*, inter-radial tentacle; *mnb*, manubrium; *mth*, mouth; *p.r.t.*, per-radial tentacle; *st*, stomach; *tn*, tentirole. (After Haeckel.)

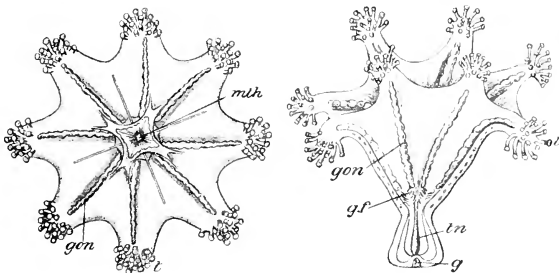

FIG. 132.—*Lucernaria*. A, oral aspect; B, from the side. *g*, foot-gland; *gf*, gastric filaments; *gon*, gonad; *mth*, mouth; *t*, tentacles; *tn*, tentiroles. (After Claus.)

(*coronary groove*) into an apical region or *cone* (*cn.*) and a marginal region or *crown*, the crown is again divided by a second, rather irregular horizontal furrow into a series of *pedal lobes* (*pd. l.*), adjacent to the cone, and a series of *marginal lappets* (*mg. lp.*), forming the free edge of the bell. In some of the Coronata, such as *Pericolpa*, the pedal lobes and marginal lappets correspond (*i.e.* are in the same radii); in others (*Periphylla*, *Ephyropsis*) they alternate.

In *Pericolpa* four of the pedal lobes, inter-radial in position, bear *tentaculoeysts* (*tc.*); four others, per-radially situated, give origin to long,

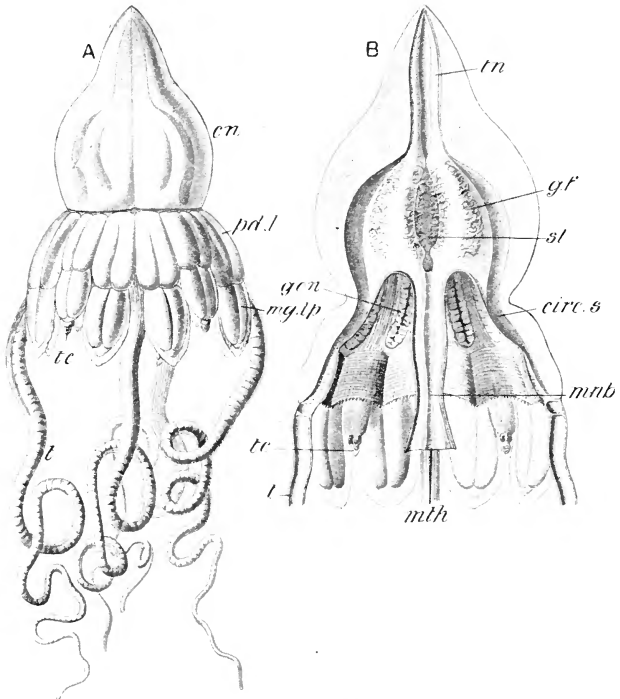

FIG. 133.—*Pericolpa quadrigata*. *A*, external view; *B*, vertical section. *circ. s.* circular sinus; *cn.* cone; *gf.* gastric filaments; *gon.* gonads; *mg. lp.* marginal lappets; *mnb.* manubrium; *mth.* mouth; *pd. l.* pedal lobes; *st.* stomach; *t.* tentacles; *tc.* tentaculoeysts; *tn.* tentacles. (Aiter Haeckel.)

hollow tentacles (*t.*). In the more complex genera there are eight additional ad-radial tentacles.

The mouth (*mth.*) is very large, and leads by a wide manubrium (*mnb.*) into a spacious stomach (*st.*), which is continued quite to the apex of the cone. In the wall of the stomach are four wide per-radial slits, leading into an immense circular sinus (*circ. s.*). As in *Lucernaria*, there are four wide inter-radial in-

fundibula. The gastric filaments (*g. f.*) are very numerous, and the elongated U-shaped gonads (*gon.*) are eight in number and ad-radial.

The coronary groove is characteristic of the group: but in other points—such as the number of pedal and marginal lobes, tentaculo-cysts, and tentacles—there is great variation. *Pericolpa* and its allies (*Peromedusæ*) resemble the *Lucernarida* and the members of the order *Cubomedusæ* in the presence of tanioles and inter-radial septa: *Ephyropsis* and its allies (*Cannostomæ*) resemble the order *Discophora* in the absence of these structures. The scyphula larva of *Nausithoë* (Fig. 134) lives as a parasite in the interior of a horny sponge.

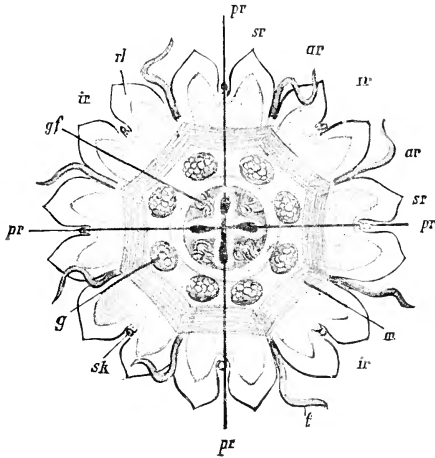

FIG. 134.—*Nausithoë*. The entire animal from the oral aspect. *ar.* adradial; *g.* gonads; *g. f.* gastric filaments; *ir.* inter-radial; *m.* circular muscle of sub-umbrella; *pr.* per-radial; *rl.* tentaculo-cysts; *sr.* sub-radial; *t.* tentacles. The black cross in the centre represents the mouth. (From Lang's *Comparative Anatomy*.)

ORDER 3.—CUBOMEDUSÆ.

The Jelly-fishes forming this order are, as the name implies, of a more or less cubical form, resembling a deep bell with somewhat flattened top and square transverse section. They resemble the hydrozoan *Medusæ* more than any of the other *Scyphozoa*. The best known species, *Charybdeæ marsupialis* (Fig. 135), is about 5 cm. in diameter and of very firm consistency.

As in the lower *Coronata*, the margin of the umbrella bears four tentacles (*t.*) and four tentaculo-cysts (*tc.*), but the position of these organs is reversed, the tentaculo-cysts being per-radial, the tentacles inter-radial. The tentaculo-cysts are set in deep marginal notches, and the tentacles spring from conspicuous gelatinous lobes (*l.*), which probably answer to the pedal lobes of the preceding order. These pedal lobes sometimes bear a number of supplementary tentacles.

The margin of the umbrella is produced, in most cases but not in all, into a horizontal shelf (*vl.*), resembling the velum of the hydroid *Medusæ*, but differing from it in containing a series of branched vessels (*end. lam'.*) continuous with the canal-system and of course lined with endoderm. In the *Hydrozoa*, it will be remembered, the velum is formed simply of a double layer of ectoderm with a supporting layer of mesogloea. Such a false velum, like the produced thin edge of the umbrella in *Aurelia*, is known as a *velarium*.

The mouth is situated at the end of a short manubrium (*mb.*) leading into a wide stomach, from which go off four very broad shallow per-radial pouches (*rad. p.*), occupying the whole of the four flat sides of the umbrella, and

separated from one another by narrow inter-radial septa or partitions (*mesenteries*) placed at the four corners. These pouches are equivalent to wide radial canals, and the partitions between them to a poorly developed endoderm lamella (*end. lam.*). At the margin of the umbrella the pouches communicate with one another by apertures in the septa, so that a kind of circular canal is produced (*circ. c.*), which is divided into chambers by the mesenteries. Near the

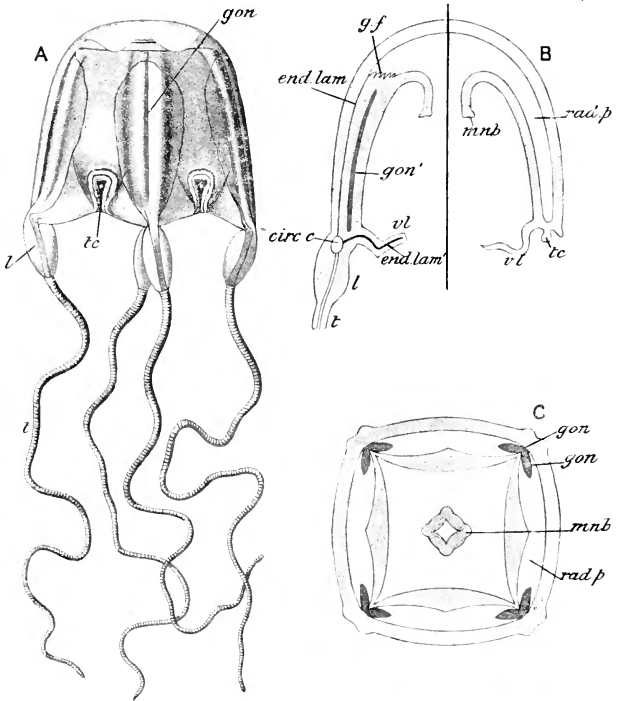

FIG. 135.—*Charybdaea marsupialis*. A, side view of the entire animal; B, vertical section passing on the left side through an inter-radius, on the right through a per-radius; C, transverse section. *circ. c.* circular canal; *end. lam.* endoderm lamella; *end. lam'*, its prolongation into the velarium; *g. f.* gastric filaments; *gon.* gonad; *gon'*, septum separating gonads; *l.* lappet; *mnb.* manubrium; *rad. p.* radial pouch; *t.* tentacle; *tc.* tentaculoecyst; *vl.* velarium. (After Claus, somewhat altered.)

junction of the gastric pouches with the stomach are the usual four groups of gastric filaments (*g. f.*).

The gonads (*gon.*) are four pairs of narrow plate-like organs, attached one along each side of each inter-radial septum. The nervous system takes the form of a sinuous nerve-ring round the margin of the bell, bearing a distinct group of nerve-cells at the base of each tentaculoecyst and tentacle. The

Cubomedusæ are the only Scyphozoa which, like the Hydrozoa, have a complete nerve-ring. The tentaculocysts are very complex, each bearing a lithocyst and several eye-spots.

ORDER 4.—DISCOMEDUSÆ.

The preceding orders are all small ones, *i.e.*, include a small number of genera and species. The vast majority of Scyphozoa belong to the present order—the “Disc-jellies” or “Sea-blubbers” as ordinarily understood.

The umbrella is always comparatively flat, having the form of an inverted saucer. The edge is produced primarily into eight pairs of marginal lappets, but in some of the more highly differentiated forms the number both of lappets and of tentaculocysts becomes greatly increased. Most of the Semostomæ and

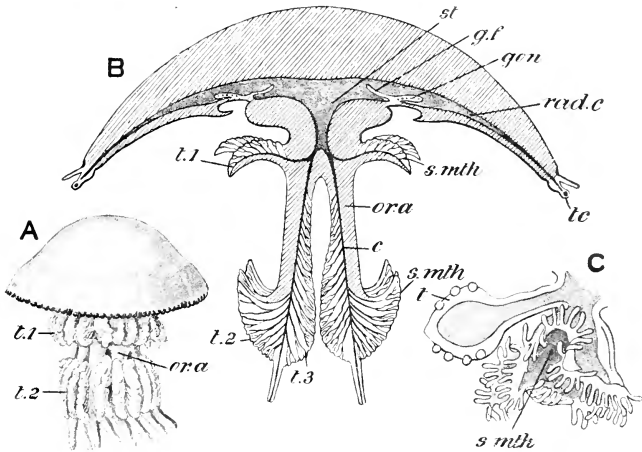

FIG. 136.—*Pilema pulmo*. A, side view of the entire animal; B, vertical section, diagrammatic; C, one of the suckorial mouths, magnified. *c.* arm canal; *g.f.* gastric filaments; *gon.* gonads; *or. a.* oral arms; *rad. c.* radial canal; *s. mth.* suckorial mouths; *st.* stomach; *t1, t2, t3,* tentacles on oral arms. (After Cuvier, Claus, and Huxley.)

Rhizostomæ are large, and one of the former group—*Cyanea arctica*—may attain a diameter of 2 metres and upwards, while its marginal tentacles reach the astonishing length of 40 metres or about 130 feet. But in spite of their size and apparent solidity, the amount of solid matter in these great Jelly-fishes is extraordinarily small; some of them have been proved to contain more than 99 per cent. of sea-water.

The marginal tentacles are hollow and often of great length in the Semostomæ (Fig. 127), and altogether absent in the Rhizostomæ (Fig. 136). In the Semostomæ there are four oral arms (Fig. 127, *or. a.*), each resembling a leaf folded along its midrib, and having more or less frilled edges: in the Rhizostomæ each of the original four arms (Fig. 136, *or. a.*) becomes divided longitudinally in the course of development, the adult members of the group being characterised by the presence of eight arms, often of great length, and variously lobed and folded so as to present a more or less root-like appearance.

The arrangement of the enteric cavity and its offshoots presents an interesting series of modifications. In no case are there any tænioles or inter-radial septa (mesenteries). In the Semostomæ (Fig. 127) the stomach-lobes give off well-defined radial canals, which are frequently more or less branched, often unite into complex networks, and sometimes open into a circular canal round the margin of the umbrella.

In the Rhizostomæ (Fig. 136, *B*) a similar network of canals is found in the umbrella, but an extraordinary change has befallen the oral or ingestive portion of the enteric system. Looking at the oral or lower surface of one of these Jelly-fishes, such as *Pilema*, no mouth is to be seen, but a careful examination of the oral arms shows the presence of large numbers—hundreds, or even thousands in some cases—of small funnel-like apertures (*B, C, s.mth.*) with frilled margins. Rhizostomes have been found with prey of considerable size, such as fishes, embraced by the arms and partly drawn into these apertures, which are therefore called the *suctorial mouths*. They lead into canals in the thickness of the arms (*B, c.*), the lesser canals unite into larger, and then finally open into the stomach (*st.*). We thus get a *polystomatous* or many-mouthed condition which is practically unique in the animal kingdom, the only parallel to it being furnished by the Sponges, in which the inhalant pores are roughly comparable with the suctorial mouths of a Rhizostome.

It has been found that this characteristic arrangement is brought about by certain changes taking place during growth. The young Rhizostome has a

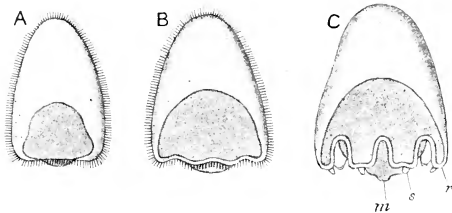

FIG. 137.—*Pelagia noctiluca*: Three developmental stages. *m.* mouth; *r.* marginal lappet; *s.* tentaculocyst. (Fom Korschelt and Heider, after Krohn.)

single mouth in the usual position, and more or less leaf-like arms, folded along the midrib so as to enclose a deep groove, from which secondary grooves pass, like the veins of a leaf, towards the edge of the arm. As development proceeds, these

converted into canals by the union of their edges, thus forming a system of branching tubes opening proximally into the angles of the mouth and distally by small apertures—the suctorial mouths—on the edges of the arms. At the same time the proximal ends of the arms grow towards one another and finally unite across the mouth, closing it completely, and forming a strong horizontal *brachial disc*, which in the adult occupies the centre of the sub-umbrellar surface.

The gastric filaments are usually very numerous. In the higher Rhizostome a remarkable modification is produced in connection with the sub-genital pouches: the four pouches approach the centre and fuse with one another, forming a single spacious chamber, the *sub-genital portico*, which lies immediately below the floor of the stomach and above the brachial disc.

In many of the Discomedusæ development takes place in the same general way as in *Aurelia*, i.e. the impregnated egg gives rise to a scyphula or asexual polype stage, which, by transverse division, produces sexual medusæ. In *Cassiopeia* the scyphula arising from the fertilised ovum gives off buds which become detached as free-swimming planulæ, and these, coming to rest, develop into scyphulæ. But in other cases there is no alternation of generations, and development is direct. For instance, in *Pelagia* (Fig. 137)—one of the Semostomæ—a blastula is formed which becomes invaginated at one end

forming a gastrula. The blastopore or gastrula-mouth remains open, and a considerable space is left between the invaginated endoderm and the ectoderm. Next the mouth region becomes elevated, forming a manubrium, and around this a circular depression appears—the rudiment of the sub-umbrellar cavity—surrounded by a raised ridge, the umbrella margin, which soon becomes divided into lobes, the marginal lappets. Up to this time the embryo is ciliated externally, but soon the cilia disappear, and the little creatures assume somewhat the form of an ephyra, which gradually develops into the adult *Pelagia*.

ADDITIONAL REMARKS ON THE SCYPHOZOA.

The Scyphozoa are all marine, and the majority are pelagic, *i.e.* swim freely on the surface of the ocean. A few inhabit the deep sea, and have been dredged from as great a depth as 2,000 fathoms. Nearly all are free-swimming in the adult stage: some, however, live on coral-reefs or mud-banks, and are found resting, in an inverted position, on the ex-umbrella; and a few, such as *Lucernaria*, are able to attach themselves at will by a definite ex-umbrellar peduncle.

Many of the Scyphozoa are semi-transparent and glassy, but often with brilliantly coloured gonads, tentacles, or radial canals. In many cases the umbrella, oral arms, &c., are highly coloured, and some species, *e.g.* *Pelagia noctiluca*, are phosphorescent. They are all carnivorous, and although mostly living upon small organisms, are able, in the case of the larger species, to capture and digest Crustaceans and Fishes of considerable size. In many cases small fishes accompany the larger forms and take shelter under the umbrella.

Considering the extremely perishable nature of these organisms, and the fact that many of them contain not more than 1 per cent. of solid matter, it is not to be expected that many of them should have left traces of their existence in the fossil state. Nevertheless, in the finely grained limestone of Solenhofen, in Bavaria, belonging to the Upper Jurassic period, remarkably perfect impressions of Jelly-fishes have been found, some of them readily recognisable as *Discomedusæ*.

CLASS III.—ACTINOZOA.

1. EXAMPLE OF THE CLASS.—A SEA-ANEMONE (*Tealia crassicornis*).

Sea-anemones are amongst the most abundant and best known of shore-animals. They are found attached to rocks, sea-weeds, shells, &c., either in rock-pools or on rocks left high and dry by the ebbing tide. Usually their flower-like form and brilliant colour make them very conspicuous objects, but many kinds cover themselves more or less completely with sand and stones, and contract so much when left uncovered by water, that they appear like soft

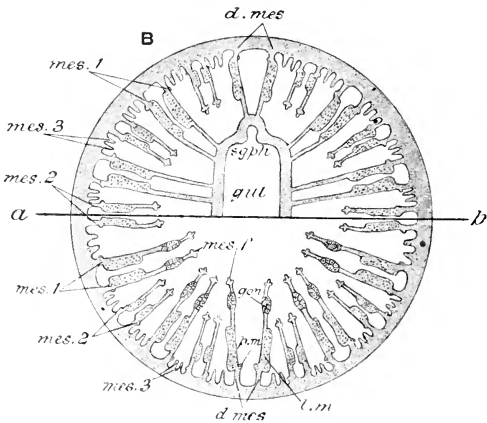
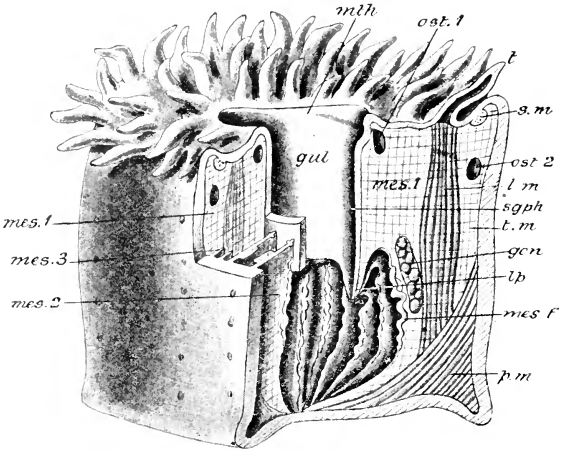

FIG. 138.—*Tealia crassicornis*. A, dissected specimen; B, transverse section, the half above the line *ab* through the gullet, the lower half below the gullet. *d. mes.* directive mesenteries; *gon.* gonads; *gul.* gullet; *l.m.* longitudinal muscle; *lp.* lappet; *mes. 1.* primary, *mes. 2.* secondary, *mes. 3.* tertiary mesenteries; *mes. f.* mesenteric filaments; *mth.* mouth; *ost. 1.* *ost. 2.* ostia; *p.m.* parietal muscle; *sgph.* siphonoglyphe; *s.m.* sphincter muscle; *l.m.* transverse muscle.

shapeless lumps stuck over with stones, and thus easily escape observation. Any of the numerous species will serve as an example of the group: the form specially selected is the "Dahlia Wartlet" (*Tealia crassicornis*), one of the commonest British species.

External Characters.—*Tealia* (Fig. 138, *A*) has the form of a cylinder, the diameter of which slightly exceeds its height. It is often as much as 3 inches (8 cm.) across, is of a green or red colour, and habitually covers itself with bits of shell, small stones, &c. It is attached to a rock or other support by a broad sole-like *base*, sharply separated from an upright cylindrical wall or *column*, the surface of which is beset with rows of adhesive warts or tubercles: at its upper or distal end the column passes into a horizontal plate, the *disc* or *peristome*. In the middle of the disc, and slightly elevated above its surface, is an elongated slit-like aperture, the *mouth* (*mt.*), from which streaks of colour radiate outwards. Springing from the disc and encircling the mouth are numerous short conical *tentacles* (*t.*), which appear at first sight to be arranged irregularly, but are actually disposed in five circles, of which the innermost contains five, the next five, the third ten, the fourth twenty, and the fifth or outermost forty, making a total of eighty.

Obviously the Sea-anemone is a *polype*, formed on the same general lines as a *Hydra* or a *scyphula*, but differing from them in having numerous tentacles arranged in multiples of five, and in the absence of a hypostome, the mouth being nearly flush with the surface of the disc. Its great size and bulk, and the comparative firmness of its substance, are also striking points of difference between *Tealia* and the polypes belonging to the classes *Hydrozoa* and *Scyphozoa*.

Enteric System.—Still more fundamental differences are found when we come to consider the internal structure. The mouth does not lead at once into a spacious undivided enteric cavity, but into a short tube (*gul.*), having the form of a flattened cylinder, which hangs downwards into the interior of the body, and terminates in a free edge, produced at each end of the long diameter into a descending lobe or *lappet* (*lp.*). This tube is the *gullet* or *stomodæum*, a structure we have already met with in the *Scyphozoa*, but which here attains a far greater size and importance. Its inner surface is marked with two longitudinal grooves (*A* and *B*, *sgph.*), placed one at each end of the long diameter, and therefore corresponding with the lappets: they are known as the *gullet-grooves* or *siphonoglyphes*.

The gullet does not simply hang freely in the enteric cavity, but is connected with the body-wall by a number of radiating partitions, the complete or *primary mesenteries* (*mes. 1*): between these are incomplete *secondary mesenteries* (*mes. 2*), which extend only part of the way from the body-wall to the gullet, and

tertiary mesenteries (*mes.* 3), which are hardly more than ridges on the inner surface of the body-wall. Thus the entire internal cavity of a Sea-anemone is divisible into three regions: (1) the *gullet* or *stomodaeum*, communicating with the exterior by the mouth, and opening below into (2) a single main digestive cavity, the *stomach* or *mesenteron*, which gives off (3) a number of radially arranged cavities, the *inter-mesenteric chambers* or *metentera*. It is obvious that we may compare the gullet and stomach with the similarly named structures in the scyphula-stage of Aurelia, and the mesenteries with the gastric ridges; indeed, there seems to be little doubt that these structures are severally homologous. A further correspondence is furnished by the presence of an aperture

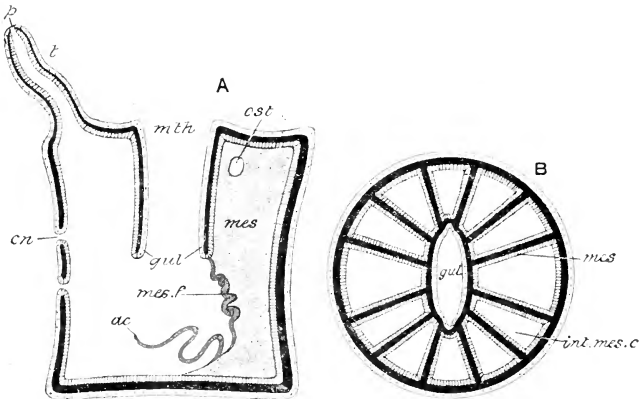

FIG. 139.—Diagrammatic vertical (A) and transverse (B) sections of a **Sea-anemone**. The ectoderm is dotted, the endoderm striated, the mesoglea black. *ac*, acantium; *cn*, cinclis; *gul*, gullet; *int. mes. c.*, inter-mesenteric chamber; *mes*, mesentery; *mes. f.*, mesenteric filament; *mth*, mouth; *ost*, ostium; *p*, pore; *t*, tentacle.

or *ostium* (*ost.* 1) in each mesentery, placing the adjacent inter-mesenteric chambers in direct communication with one another: in Tealia a second ostium (*ost.* 2) is present near the outer edge of the mesentery. Moreover, the free edge of the mesentery below the gullet is produced into a curious twisted cord, the *mesenteric filament* (*mes. f.*), answering to a gastric filament of the Scyphozoa. In many Sea-anemones the mesenteric filaments are produced into slender threads—the *acontia*—which may be protruded through the mouth or through special apertures (*cinclides*) of the body-wall (Fig. 139, A).

The general arrangement of the **cell-layers** is the same as in the two preceding classes. The body-wall (Fig. 139)—base, column, and disc—consists of a layer of ectoderm outside, one of endoderm

within, and between them an intermediate layer or mesogloea, which is extremely thick and tough. The gullet (*gul.*), which, like that of the scyphula, is an in-turned portion of the body-wall, is lined with ectoderm, and its outer surface—*i.e.* that facing the inter-mesenteric chambers—is endodermal. The mesenteries (*mes.*) consist of a supporting plate of mesogloea, covered on both sides by endoderm. The tentacles (*t*) are hollow out-pushings of the disc, and contain the same layers.

Muscular System.—Sea-anemones perform various characteristic movements: the column may be extended or retracted, the tentacles extended to a considerable length, or drawn back and completely hidden by the upper end of the column being folded over them like the mouth of a bag; the gullet, and even the mesenteries, may be partially everted through the mouth; and lastly, the whole animal is able, very slowly, to change its position by creeping movements of its base.

These movements are performed by means of a very well-developed set of *muscles*. A mesentery examined from the surface is seen to be traversed by definite fibrous bands, the two most obvious of which are the *longitudinal* or *retractor muscle* (Fig. 138, *l.m.*), running as a narrow band from base to disc, and the *parietal muscle* (*p.m.*), passing obliquely across the lower and outer angle of the mesentery. Both these muscles are very thick, and cause a projection or bulging on one side of the mesentery, specially obvious in a transverse section (*B*, *l.m.*): a third set of fibres, forming the *transverse muscle* (*t.m.*), crosses the longitudinal set at right angles, but is not specially prominent. The longitudinal muscles shorten the mesentery, and draw the disc downwards or towards the base, thus retracting the tentacles; the parietal muscles approximate the column to the base, and the transverse fibres produce a narrowing of the mesentery and thus, opposing the action of the longitudinal muscles, act as extensors of the whole body. The withdrawal of disc and tentacles, during complete retraction, has been compared to the closure of a bag by tightening the string, and is performed in much the same way, the string being represented by a very strong band of fibres, the *circular* or *sphincter muscle* (*s.m.*), which encircles the body at the junction of the column and disc.

The foregoing muscles can all be seen by the naked eye, or under a low magnifying power. They are supplemented by fibres, only to be made out by microscopic examination, occurring both in the body-wall and in the tentacles. The latter organs, for instance, are able to perform independent movements of extension and retraction by means of delicate transverse and longitudinal fibres.

It was mentioned above that the thickness of the longitudinal and parietal muscles produces a bulging on one surface of the mesenteries. A transverse section shows that the arrangement of

the mesenteries and of their muscles is very definite and characteristic (Fig. 138, B). At each end of the gullet, opposite the siphonoglyphe, are two mesenteries (*d. mes.*), having their longitudinal muscles turned away from one another: they are distinguished as the *directive mesenteries*, and, in the case of *Tealia*, there are two couples of directive mesenteries, one at each end of the long axis of the gullet. Of the remaining complete or primary mesenteries there are four couples on each side (*mes. 1*), differing from the directive mesenteries in having the longitudinal muscles turned towards one another. The secondary and tertiary

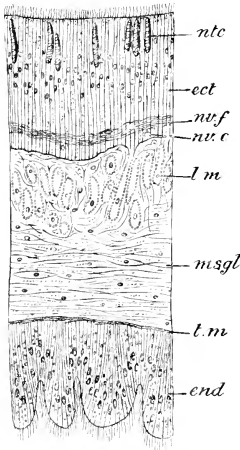

FIG. 140.—*Tealia crassicornis*. Transverse section of tentacle. *ect.* ectoderm; *end.* endoderm; *l.m.* longitudinal muscles; *msgl.* mesogloea; *nv. c.* nerve-cells; *nv. f.* nerve-fibres; *ntc.* nematocysts; *t. m.* transverse muscles. (After Hertwig.)

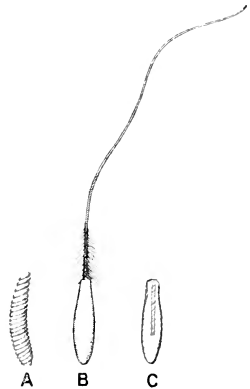

FIG. 141.—Three nematocysts of *Sagartia*. (After Hertwig.)

mesenteries (*mes. 2*, *mes. 3*) are also arranged in couples, and in all of them the longitudinal muscles of each couple face one another.

Symmetry.—It will be noticed that *Tealia*, unlike the typical hydrozoan and scyphozoan polypes, presents a distinct *bilateral symmetry*, underlying, as it were, its superficial radial symmetry. It is divisible into equal and similar halves by two planes only, viz., a *vertical or sagittal plane* taken through the long diameter of the gullet, and a *transverse plane* taken through its short diameter.

The general **microscopic structure** of a Sea-anemone is well shown by a section through a tentacle (Fig. 140). Both ectoderm (*ect.*) and endoderm (*end.*) consist mainly of very long columnar,

ciliated epithelial cells, and the mesogloea (*msgl.*) is not only extremely thick, but has the general characters of connective tissue, being traversed by a network of delicate fibres with interspersed cells. The middle layer has, in fact, ceased to be a mere gelatinous supporting lamella or *mesogloea*, and has assumed, to a far greater extent than in any of the lower groups, the characters of an intermediate cell-layer or *mesoderm*.

Stinging-capsules occur in the ectoderm, and are also very abundant in the mesenteric filaments. They (Fig. 141) resemble in general characters the nematocysts of Hydrozoa, but are of a more elongated form, and the thread is usually provided at the base with very numerous slender

barbs (*B*). Very frequently the coiled thread is readily seen in the undischarged capsule (*A*). Gland-cells (Fig. 142, *gl.*) are very abundant in the ectodermal lining of the gullet and in the mesenteric filaments: the latter are trilobed in section, and the gland-cells are confined to the middle portion, the lateral divisions being invested with ordinary ciliated cells (*c.*). In virtue of possessing both stinging-capsules and gland-cells, the mesenteric filaments perform a double function. The animal is very voracious, and is able to capture and swallow small Fishes, Molluscs, Sea-urchins, &c. The prey is partly paralysed, before ingestion, by the nematocysts of the tentacles, but the process is completed, after swallowing, by those of the mesenteric filaments. Then as the captured animal lies in the stomach, the edges of the filaments come into close contact with one another and practically surround it, pouring out, at the same time, a digestive juice secreted by their gland-cells.

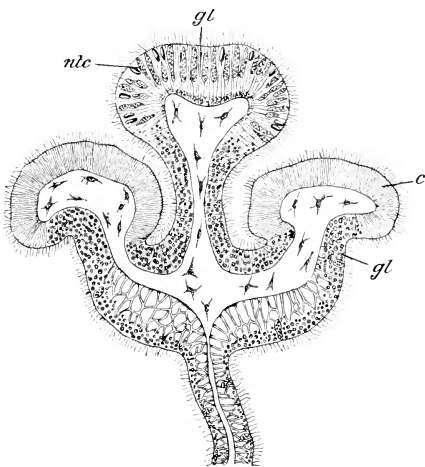

FIG. 142.—Transverse section of mesenteric filament of *Sagartia*. *c.* ciliated cells; *gl.* gland-cells; *ntc.* nematocysts. (After Hertwig.)

mesenteric filaments perform a double function. The animal is very voracious, and is able to capture and swallow small Fishes, Molluscs, Sea-urchins, &c. The prey is partly paralysed, before ingestion, by the nematocysts of the tentacles, but the process is completed, after swallowing, by those of the mesenteric filaments. Then as the captured animal lies in the stomach, the edges of the filaments come into close contact with one another and practically surround it, pouring out, at the same time, a digestive juice secreted by their gland-cells.

The muscles described above consist partly of spindle-shaped nucleated fibres, and partly of muscle-processes, like those of

Hydra: the latter occur chiefly in the transverse muscular layer of the tentacles and are endodermal, the longitudinal layer is formed of distinct fibres of ectodermal origin: the great muscles of the mesenteries are of course endodermal. Although always derived either from the ectoderm or endoderm, many of the muscle-fibres of *Tealia* undergo a remarkable change of position by becoming sunk in the mesogloea, and thus appearing to belong to that layer (Fig. 140 *l.m.*). This fact is significant from the circumstance that, as we shall see, the muscles of all animals above Cœlenterata are mesodermal structures.

The **nervous system** is very simple. It consists of a layer of delicate fibres lying between the epithelial and muscular layers of the ectoderm. Among the fibres are found nerve-cells (Fig. 140, *nv.c.*), often of large size, and occurring chiefly in the disc and tentacles. Thus, as in the polype-forms previously described, the nervous system is in a generalised condition, and shows no concentration into a definite central nervous system such as occurs in *Medusæ*.

Reproductive Organs.—Sea-anemones are dioecious, the sexes being lodged in distinct individuals. The gonads—ovaries or testes—are developed in the substance of the mesenteries (Fig. 138, *gon.*), a short distance from the edge, and, when mature, often form very noticeable structures. The reproductive products are obviously, as in the Scyphozoa, lodged in the endoderm. The sperms, when ripe, are discharged into the stomach and escape by the mouth: they are then carried, partly by their own movements, partly by ciliary action, down the gullet of a female, where they find their way to the ovaries and impregnate the eggs.

The **development** of Sea-anemones resembles, in its main features, that of Scyphozoa. The oosperm undergoes more or less regular division, the details differing considerably in individual cases, and becomes converted into a *planula*, an elongated ovoidal body with an outer layer of ciliated ectoderm and an inner layer of large endoderm cells, surrounding a closed enteric cavity, usually filled with a mass of yolk, which serves as a store of nutriment.

In this condition the embryo escapes from the parent, through the mouth, swims about for a time, and then settles down, becoming attached by its broader or anterior end. At the opposite or narrow end a pit appears, the rudiment of the stomodæum; this deepens, and, its lower or blind end becoming perforated, effects a communication with the enteron.

The mesenteries are developed in regular order, but in a way which would certainly not be suspected from their arrangement in the adult. First of all, a single pair of mesenteries (Fig. 143, *A, I*) grow from the body-wall to the gullet, being situated one on each side of the vertical plane, at right angles to the long diameter of the stomodæum, and near one end of that tube. The enteron thus becomes divided into two chambers, a larger or *dorsal* and a smaller or *ventral*, and the embryo acquires a distinct bilateral symmetry. Next a pair of mesen-

teries (2) appear in the dorsal chamber, dividing it into a median and two lateral compartments; then a third pair (3) in the ventral chamber, producing a similar division; then a fourth pair (4) in the middle compartment of the dorsal chamber; then a fifth pair (B, 5) in the lateral compartments of the dorsal chamber; and a sixth pair (6) in the lateral compartments of the ventral chamber. Soon the longitudinal muscles are developed, and the fate of these primitive pairs of mesenteries can be seen. The third and fourth pairs become the two directive couples of the adult; another couple of primary mesenteries is constituted, on each side of the vertical plane, by one of the mesenteries of the first and one of the sixth pair; a third couple is similarly formed by a mesentery of the second and one of the fifth pair. Thus it is only in the case of the directive mesenteries that an adult couple coincides with an embryonic pair: in other instances the two mesenteries of a couple are of different orders, belonging to distinct embryonic pairs. The mesenteric filaments of the first

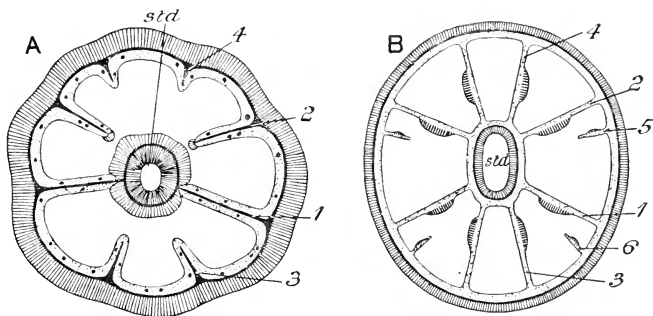

FIG. 143.—Transverse sections of early (A) and later (B) stages of an embryo Sea-anemone (*Actinia*). The mesenteries are numbered in the order of their development; *std*, stomodæum. (After Korschelt and Heider.)

cycle of mesenteries are partly ectodermal, partly endodermal in origin, those of the remainder entirely endodermal.

The tentacles are developed in a somewhat similar order to that of the development of the mesenteries. The first to make its appearance is connected with the larger or dorsal enteric chamber mentioned above: for some time it remains much longer than any of its successors, and thus accentuates in a marked degree the bilateral symmetry of the embryo.

It will be noticed that the development of the Sea-anemone is accompanied by a well-marked metamorphosis, but that there is no alternation of generations. In this respect its life-history offers a marked contrast with that of *Obelia*.

2. DISTINCTIVE CHARACTERS AND CLASSIFICATION.

The Actinozoa are Cœlenterata which exist only in the polypeform, no medusa-stage being known in any member of the class. The actinozoan differs from the hydrozoan polype mainly in possessing a stomodæum: it differs from the hydrozoan and many scyphozoan polypes in the possession of mesenteries or vertical radiating partitions, which extend inwards from the body-wall

and some of which join the stomodæum. The free margins of the mesenteries bear coiled mesenteric filaments, which appear to answer to the gastric filaments of Scyphozoa, but may be partly ectodermal in origin. The mesenteries are developed in pairs, symmetrically on each side of a vertical plane: their final radial arrangement is secondary.

The body-wall consists of ectoderm and endoderm separated by a stout mesogloea containing fibres and cells. The stomodæum consists of the same layers reversed—*i.e.* its lining membrane is ectodermal. The mesenteries are formed of a double layer of endoderm with a supporting plate of mesogloea. Nematocysts, frequently of a more complex form than those of Hydrozoa and Scyphozoa, are present in the tentacles, body-wall, stomodæum, and mesenteric filaments. The muscular system is well developed, and contains both ectodermal and endodermal fibres and endodermal muscle-processes. The nervous system consists of irregularly disposed cells and fibres; there is no concentration of these elements to form a central nervous system.

The gonads are developed in the mesenteries, the sex-cells are lodged in the endoderm, and the ripe sexual products are discharged into the enteron. The impregnated egg develops into a planula, which, after a short free existence, settles down and undergoes metamorphosis into the adult form. Except in one doubtful instance there is no alternation of generations.

In some Actinozoa the animal remains simple throughout life, but in most members of the class an extensive process of budding takes place, the result being the formation of colonies of very various form and often of great size. Some kinds, again, resemble *Tealia* in having no hard parts or skeletal structures of any kind; but the majority possess a skeleton, formed either of carbonate of lime or of a horn-like or chitinous material, and developed, in most cases though not in all, from the ectoderm.

The Actinozoa are classified as follows:—

Sub-Class I.—Zoantharia.

Actinozoa in which the tentacles and mesenteries are usually very numerous and are frequently arranged in multiples of five or six. The tentacles are usually simple, unbranched, hollow cones. There are commonly two siphonoglyphes and two pairs of directive mesenteries: the remaining mesenteries are usually arranged in couples with the longitudinal muscles of each couple facing one another.

ORDER I.—ACTINIARIA.

Zoantharia which usually remain simple, but in a few instances form small colonies. The tentacles and mesenteries are numerous, and there is no skeleton. This order includes the Sea-anemones.

ORDER 2.—MADREPORARIA.

Zoantharia which resemble the Actiniaria in the general structure of the soft parts, but which usually form colonies, and always possess an ectodermal calcareous skeleton. This order includes the vast majority of Stony Corals (Figs. 147 and 157).

ORDER 3.—ANTIPATHARIA.

Compound tree-like Zoantharia in which the tentacles and mesenteries are comparatively few (6—24) in number. A skeleton is present in the form of a branched chitinous axis, developed from the ectoderm, which extends throughout the colony. This order includes the “Black Corals” (Fig. 151).

Sub-Class II.—Alcyonaria.

Actinozoa in which the tentacles and mesenteries are always eight in number. The tentacles are pinnate, *i.e.* produced into symmetrical branchlets. There is never more than one siphonoglyphe, which is ventral in position, *i.e.* faces the proximal end of the colony. The mesenteries are not arranged in couples, and their longitudinal muscles are all directed ventrally, *i.e.* towards the same side as the siphonoglyphe.

ORDER 4.—ALCYONACEA.

Alcyonaria in which the skeleton usually consists of calcareous spicules or small irregular bodies occurring in the mesogloea, but probably originating from wandering ectoderm cells. The common “Dead men’s fingers” (*Alcyonium*, Fig. 154) has a skeleton of this type. In some cases the spicules become aggregated so as to produce a coherent skeleton, which may form a branched axis to the whole colony, as in the precious Red Coral (*Corallium*, Fig. 146), or a series of connected tubes for the individual polypes, as in the Organ-pipe Coral (*Tubipora*, Fig. 149). In the “Blue Coral” (*Heliopora*) the skeleton is a massive structure resembling that of the Madreporaria. Most genera are compound; a few, such as *Harteria*—which, however, is probably a larval form (Fig. 145)—are simple.

ORDER 5.—GORGONACEA.

Compound tree-like Alcyonaria, with a calcareous or horny skeleton of ectodermal origin forming a branched axis throughout the colony. Spicules are present in the mesogloea. There is no siphonoglyphe. The beautiful “Sea-fans” belong to this group (Fig. 155).

ORDER 6.—PENNATULACEA.

Alcyonaria in which the colony is usually elongated, and has one end embedded in the mud at the sea-bottom, while the opposite or distal end bears the polypes, usually on lateral branches. The stem is supported by a calcareous or horny skeleton. The polypes are dimorphic. The "Sea-pens" (*Pennatula*) are the commonest members of this group (Fig. 148).

Systematic Position of the Example.

Tealia crassicornis is one of several species of the genus *Tealia*: it belongs to the family *Tealidæ*, which, with several other families, make up the tribe *Hexactiniæ*, of the order *Actiniaria*, of the sub-class *Zoantharia*.

The presence of numerous tentacles, arranged in multiples of five, places it at once among the *Zoantharia*. The fact that it is simple and devoid of a skeleton causes it to be assigned to the *Actiniaria*. This order is divided into tribes characterised by differences in the arrangement of the mesenteries, especially by the presence of one or two couples of directive mesenteries, and by the direction in which the longitudinal muscles face. In the *Hexactiniæ* the mesenteries are all arranged in couples with the longitudinal muscles of each couple facing one another, except in the case of the two directive couples. The mesenteries are in multiples of five, and the stomodæum has two siphonoglyphes and two lappets.

The family *Tealidæ* is characterised by the possession of numerous mesenteries, of tentacles of moderate length which are completely covered by the closed-in disc during retraction, and by the presence of a large endodermal sphincter muscle. The genus *Tealia* is distinguished from other members of the same family by being broader than high, by having numerous retractile, equal-sized tentacles, and by the presence of longitudinal series of warts on the column. The species *crassicornis* is distinguished from other species of the genus by the warts being of approximately equal size.

3. GENERAL ORGANISATION.

The chief variations in the **external form** of the Actinozoa are due to the diverse modes of budding: as we shall see, the structure of the individual polypes or zooids is remarkably uniform—at least as regards all the essentials of their organisation.

Nearly all the *Actiniaria* or Sea-anemones are simple, and in the few instances where colonies are formed, these are usually small, and contain a very limited number of zooids. In *Zoanthus* (Fig. 144), for instance, the original polype sends out a horizontal branch or *stolon* (*st.*), from which new polypes arise. Besides the

Sea-anemones the only simple forms are certain Madreporarian corals, such as *Flabellum* (Fig. 156, *A, B*), and three genera of Alcyonacea, of which *Hartea* (Fig. 145) may be taken as an example.

The simplest mode of budding is that just described in *Zoanthus*, in which new zooids are developed from a narrow band-like or tubular stolon (Fig. 144, *st*). A more usual method resembles that with which we are already familiar in Hydrozoa, new buds being formed as lateral out-growths, and a tree-like colony arising with numerous zooids springing from a common stem or cœnosarc.

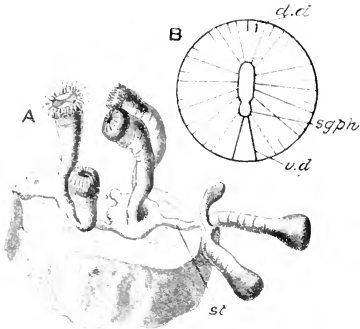

FIG. 144.—*Zoanthus sociatus*. *A*, entire colony; *st*, stolon. *B*, transverse section. *siph*, siphonoglyphs; *d. d.*, dorsal and *v. d.*, ventral directive mesenteries. (After McMurrich and Korschelt and Heider.)

Corallium and Gorgonia (Figs. 146 and 155) are good examples of this type of growth. In other cases the buds grow more or less parallel with one another,

producing massive colonies either of close-set zooids or of zooids separated by a solid cœnosarc. As examples of this type we may take *Palythoa*, the most complex of the Actinaria, and many of the common Madreporaria, such as *Astraa* (Fig. 147). In the Sea-pens (*Pennatulacea*) the proximal end of the elongated colony (Fig. 148) is sunk in the mud, and the distal end bears zooids springing either directly from the cœnosarc or, as in *Pennatula* itself, from flattened lateral branches. The stem itself is the equivalent of a polype.

A very peculiar mode of budding occurs in the Organ-pipe Coral (*Tubipora*). The base of the original polype (Fig. 149) grows out into a flattened expansion from which new polypes

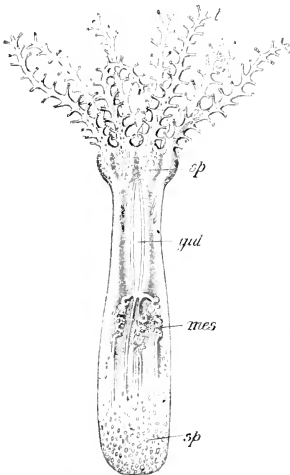

FIG. 145.—*Hartea elegans*. *gul*, gullet; *mes*, mesentery; *sp*, spicules; *t*, tentacles. (After Perceval Wright.)

arise, diverging slightly from one another as they grow, and separated by tolerably wide intervals. The distal ends of the polypes then grow out into horizontal expansions or *platforms* (*pl.*), formed at first of ectoderm and mesogloea only, but finally receiving prolongations of the endoderm. The platforms extend, come in contact with one another, and fuse. In this way platforms of considerable extent are formed (*A, pl.*), uniting the polypes with one another. From the upper surfaces of the platforms, between the older polypes, new buds arise, and in this way the colony tends to assume the form of an inverted pyramid, the number of zooids, and consequently the diameter of the colony, increasing *pari passu* with the vertical growth of the latter. The skeleton of this remarkable coral will be referred to hereafter.

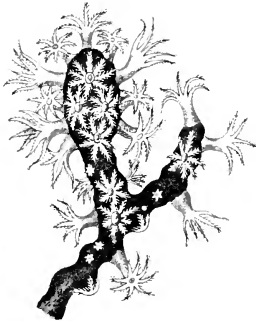

FIG. 146.—*Corallium rubrum*, portion of a branch. (From Claus, after Lacaze-Duthiers.)

Although the general structure of the individual polypes of the Actinozoa is, as mentioned above, very uniform, the variations in detail are numerous and interesting, especially among

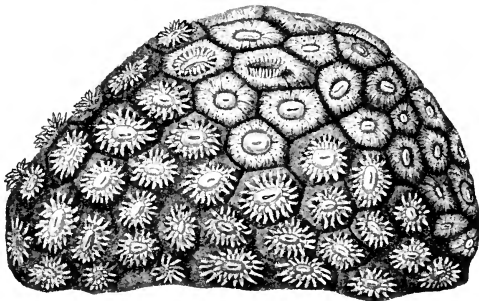

FIG. 147.—*Astræa pallida*, the living colony. (After Dana.)

the Actiniaria. One of the most important points to consider is the *arrangement of the mesenteries*. In *Edwardsia* (Fig. 150), a genus which burrows in sand instead of attaching itself to rocks, &c., there are only eight mesenteries (B)—the usual two couples of directives, and two others on each side of the vertical plane, having their longitudinal muscles directed ventrally, and therefore not arranged in couples. The adult *Edwardsia* thus

corresponds with a temporary stage in the development of one of the more typical Sea-anemones, viz., the stage with eight mesenteries shown in Fig. 143, *A*; it is probably to be looked upon as the most primitive or generalised member of the order. In *Zoanthus* (Fig. 144, *B*) the dorsal directives (*d.d.*) do not reach the gullet, and each lateral couple consists of one perfect and one small and imperfect mesentery. In *Cerianthus*, another burrowing form, there are a couple of very small ventral directives, and the remaining mesenteries are very numerous, not arranged in couples, and all directed ventrally at their outer ends, so as to

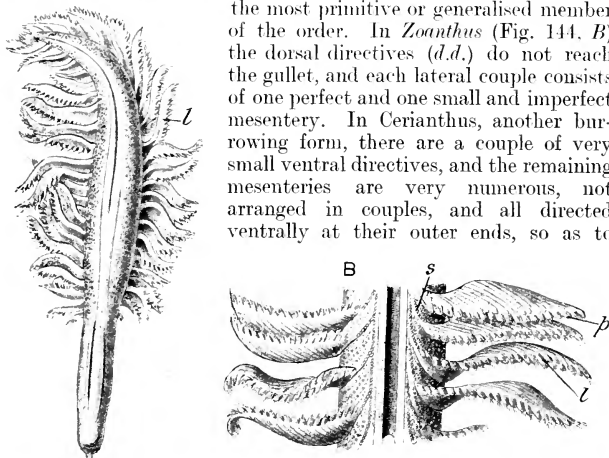

FIG. 148.—*Pennatula sulcata*. *A*, entire colony; *B*, portion of the same magnified. *l*, lateral branch; *p*, polyp; *s*, siphonozoid. (After Koelliker.)

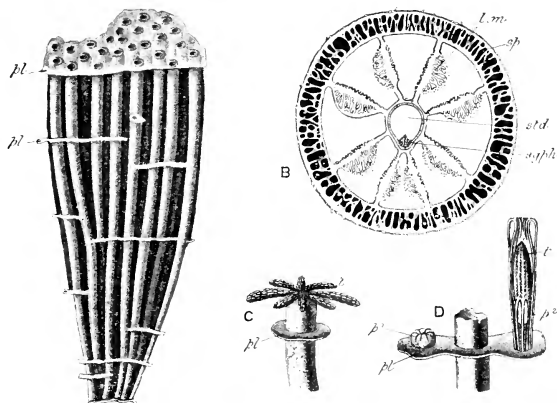

FIG. 149.—*Tubipora musica*. *A*, skeleton of entire colony; *B*, transverse sections of polyp. *C*, single polyp with tube and commencement of platform; *D*, growth of new polypes from platform. *l. m.*, longitudinal muscles; *p¹*, *p²*, polypes; *pl*, platform; *std.*, siphonoglyphe; *sp.*, spicules; *std.*, stomodæum. (After Cuvier, Quoy and Gaimard, and Hickson.)

have a very obviously bilateral arrangement: in this genus, as growth proceeds, new mesenteries are added on the dorsal side, and not, as is usual, between already formed couples. On the other hand, the genus *Gyactis* exhibits a perfectly radial arrangement: the mesenteries are all arranged in couples with the longitudinal muscles facing one another. Lastly, in all the more typical Sea-anemones (forming the tribe *Hexactiniæ*) there are either six, eight, or ten pairs of perfect mesenteries, which, as well as the secondary and tertiary cycles, are all arranged in couples, the longitudinal muscles of all but the one or two directive couples facing one another.

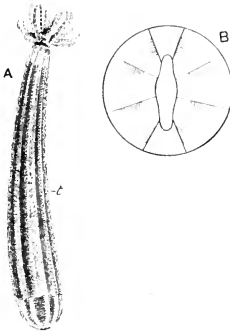

FIG. 150.—*Edwardsia claparèdii*.
A, the entire animal; t, tube. B,
transverse section. (After Andres,
and Korschelt and Heider.)

In the Madreporaria the mesenteries are arranged, so far as is known, in the way just described for the Hexactiniæ. In the Antipatharia there are six primary and sometimes either four or six secondary mesenteries. In the whole of the Alcyonaria the mesenteries are eight in number: they are not arranged in couples, and their longitudinal muscles all face the same way, viz., towards the ventral aspect (Fig. 149, B). In this whole sub-class, therefore, the resemblance to *Edwardsia* is very close, the main difference being that the longitudinal muscles of the ventral directives face inwards in the Alcyonaria, outwards in *Edwardsia*.

The *tentacles* in Zoantharia are usually very numerous, and in nearly all cases have the form of simple glove-finger-like out-pushings of the disc. In *Edwardsia*, however, they may be reduced to sixteen, and in some genera of Sea-anemones they are branched. In the Antipatharia (Fig. 151) they vary in number from six to twenty-four. When more than six are present, six of them are larger than the others.



FIG. 151.—*Antipathes ternatensis*, portion of a branch, showing three zooids and the horny axis beset with spines. (From the *Cambridge Natural History*, after Schultze.)

In the Alcyonaria, on the other hand, the tentacles, like the mesenteries, are eight in number and are always pinnate, i.e. slightly flattened and with a row of small branchlets along each edge (Fig. 145). Many Actinaria have the tentacles

perforated at the tip (Fig. 139, *A*, *p.*); and in some species these organs undergo degeneration, being reduced to apertures on the disc, which represent the terminal pores of the vanished tentacles and are called *stomidia*.

Many Sea-anemones possess curious organs of offence called *acontia* (Fig. 139, *A*, and Fig. 158, *ac.*). These are long delicate threads springing from the edges of the mesenteries: they are loaded with nematocysts, and can be protruded through minute apertures in the column, called "port-holes" or *cinclides* (*cn.*).

Enteric System.—The *gullet* in the Actinaria presents some remarkable modifications. It is usually a compressed tube with two siphonoglyphes, but in *Zoanthus* and some other genera the ventral gullet-groove alone is present (Fig. 144, *B*), and in *Gyactis* both grooves are absent, and the tube itself is cylindrical with a circular mouth. The ordinary compressed form of gullet often assumes, in the position of rest, an ∞ -shaped transverse section, owing to

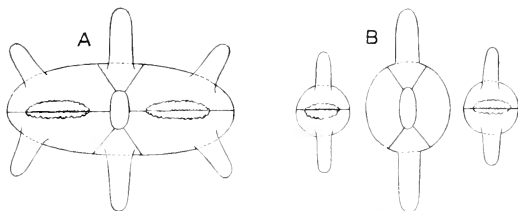

FIG. 152.—**Antipatharia.** *A*, oral face of zooid of *Parantipathes*. *B*, oral face of zooid of *Schizopathes*. (After Delage et Hérouard.)

its walls coming together in the middle and leaving the two ends wide open. In most of the *Antipatharia* the zooid is drawn out in the direction of the long axis of the branch (Fig. 152), and in some it becomes constricted into three parts (*B*) which may have the appearance of separate zooids, the central part containing the gullet with the mouth, while each of the lateral parts contains a gonad; each of these apparent zooids bears two of the six tentacles; the median one has all six mesenteries attached internally to the gullet; in each lateral part there is only the outer portion of one of the transverse mesenteries. In such a form as *Schizopathes* (Fig. 152, *B*) there is thus recognisable an arrangement of the parts which might be interpreted as a dimorphism of the zooids, one set—the parts containing the mouth and gullet—being regarded as *gastrozooids*, and the others containing the gonads as *gonozooids*.

Fixed and Free Forms.—A large proportion of Actinozoa are permanently fixed, such, for instance, as most of the Stony Corals, the Sea-fans, Black Corals, &c. Most Sea-anemones are temporarily attached by the base, but are able slowly to change their

position: some forms, such as *Edwardsia* (Fig. 150) and *Cerianthus*, usually live partly buried in sand enclosed in a tube formed of discharged stinging-capsules, the oral end with its crown of tentacles alone being exposed: others, such as *Peachia*, live an actually free life, habitually lying on the sea-bottom with the longitudinal axis horizontal like that of a worm: a few, such as *Minyas* (Fig. 153), have the aboral end dilated into a sac containing air and serving as a float; by its means these animals can swim at the surface of the sea, and are thus, alone among the Actinozoa, pelagic.



FIG. 153.—*Minyas*.
f. float. (After
Andres.)

Dimorphism.—With the exception of one genus of Stony Corals, the Zoantharia are all homomorphic, *i.e.* there is no differentiation of the zooids of a colony. But in the Alcyonaria dimorphism is common: the ordinary zooids or polypes are accompanied by smaller individuals, called *siphonozooids* (Fig. 148, *s.*), having no tentacles, longitudinal muscles, or gonads.

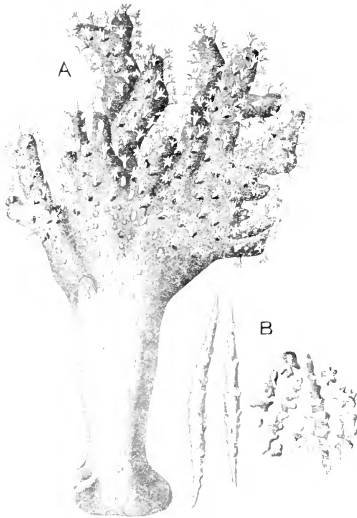

FIG. 154.—*Alcyonium palmatum*, A, entire colony; B, spicules. (After Cuvier.)

None of the Actiniaria have a true **skeleton**: in some, however, there is a thick cuticle, and several kinds enclose themselves in a more or less complete tube (Fig. 150), which may be largely formed of discharged nematocysts. The simplest form of skeleton is found in the solitary Alcyonarian genus *Hartea* (Fig. 145), already referred to, in which minute irregular deposits of calcium carbonate, called *spicules* (*sp.*), are deposited in the mesoglaea. A similar *spicular skeleton* occurs

in the "Dead-men's finger" (*Alcyonium*, Fig. 154), where spicules of varying form are found distributed throughout the mesoglaea of the coenosarc. In *Tabipora* (Fig. 149), the "Organ-pipe Coral," the mesoglaeal spicules become closely fitted together, and form a continuous tube for each polype, the

tubes being united by horizontal calcareous platforms (*pl.*) formed by deposits of spicules in the expansions of the same name already referred to. The skeleton of *Tubipora* is, therefore, an internal skeleton, and in the living state is covered by ectoderm. In the Red Coral of commerce (*Corallium*, Fig. 146) the originally separate spicules are embedded in a cement-like deposit of carbonate of lime, the result being the production of an extremely hard and

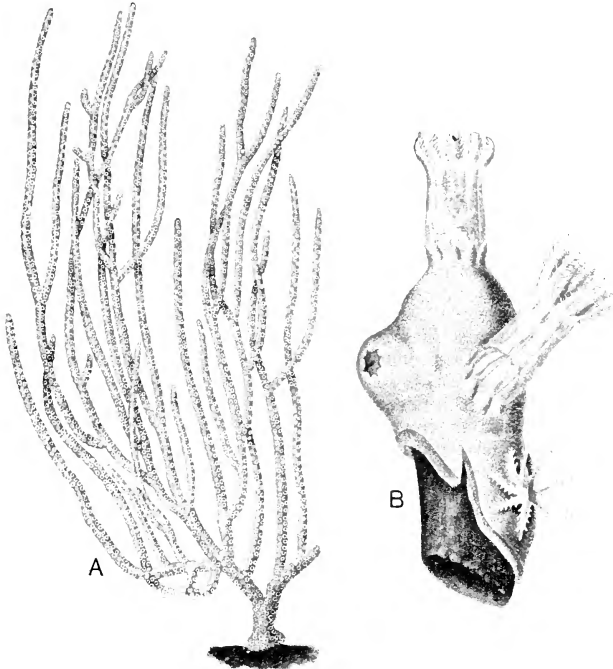

FIG. 155.—*Gorgonia verrucosa*. A, entire colony; B, portion of the same magnified. (After Koch and Cuvier.)

dense branched rod, which extends as an axis through the cœnosarc. In the Blue Coral (*Heliopora*), on the other hand, the stony calcareous skeleton is not made up of fused spicules, but is solid from the first.

Another type of skeleton is found in the Antipatharia (Fig. 151) and in the Gorgonacea (Fig. 155). It also consists of an axial rod, extending all through the colony and branching with it, but is

formed of a flexible horn-like material. Moreover it is not mesoglœal, but ectodermal in origin: in close contact with it is an epithelium, from the cells of which it is produced as a cuticular secretion, and this epithelium is formed as an invagination of the base of the colony. In addition to its axis, *Gorgonia* contains numerous spicules in the mesoglœa of the cœnosarc. In some of the Gorgonacea the axial skeleton is partly horny, partly calcareous.

In the Sea-pen (*Pennatula*, Fig. 148) and its allies the stem of the colony is supported by a horny or calcareous axis which is unbranched, not extending into the lateral branches. In this case the axis is contained in a closed cavity lined by an epithelium, the origin of which is still uncertain. Spicules occur in the mesoglœa, some of them microscopic, others readily visible to the naked eye.

In the Madreporaria we have a skeleton of an entirely different type, consisting, in fact, of a more or less cup-like calcareous structure, secreted from the ectoderm of the base and column of the polype. When formed by a solitary polype, such a "cup-coral" is known as a *corallite*: in the majority of species a large number—sometimes many thousands—of corallites combine to form a *corallum*, the skeleton of an entire coral-colony.

The structure of a corallite is conveniently illustrated by that of the solitary genus *Flabellum* (Fig. 156, *A*, *B*). It has the form of a short conical cup, much compressed so as to be oval in section. Its wall or *theca* (*th.*) is formed of dense stony calcium carbonate, white and smooth inside, rough and of a brownish colour outside, except towards the margin, where it is white. Its proximal or aboral end is produced into a short stalk or *peduncle*, by which the Coral is attached in the young state, becoming free when adult: in many other simple Corals there is no stalk, but attachment to the support is effected by means of a flattened proximal surface or *basal plate* (*C*, *b. pl.*). From the inner surface of the theca a number of radiating partitions, the *septa* (*sep.*), proceed inwards or towards the axis of the cup, and, like the mesenteries of a polype, are of several orders, those extending furthest towards the centre being called primary septa, the others secondary, tertiary, and so on. Towards the bottom of the cup the primary septa meet in the middle to form an irregular central mass, the *columella* (*col.*). In some Corals the columella is an independent pillar-like structure arising from the basal plate (*D*, *col.*).

In many Corals there is a distinct calcareous layer investing the proximal portion of the theca, and called the *epitheca* (*C*, *e.th.*). Some species have the inner portions of the septa detached so as to form a circlet of narrow upright columns, the *pali*. In others there are horizontal partitions or *dissepiments* passing from septum to septum, and in others, again, complete partitions or *tabulæ*, like those of *Millepora* (p. 158), extending across the whole corallite. \ In

the Mushroom-coral (*Fungia*) the corallite is discoid, the theca is confined to the lower surface, and small calcareous rods, the *synapticula*, connect the septa with one another.

In the living condition the polype fills the whole interior of the corallite and projects beyond its edge to a greater or less degree according to its state of expansion (C). The proximal part of the

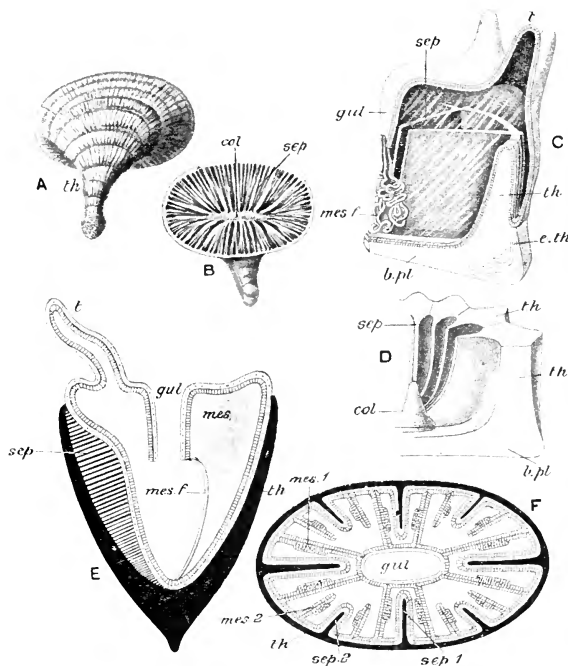

FIG. 156.—A, B, two views of *Flabellum curvatum*. C, semi-diagrammatic view of a simple coral; D, portion of a corallite; E, F, diagram of a simple coral in longitudinal and transverse section; ectoderm dotted, endoderm striated, skeleton black. *b. pl.* basal plate; *col.* columella; *e. th.* epitheca; *gul.* gullet; *mes.*, *mes. 1.*, *mes. 2.*, mesenteries; *mes. f.* mesenteric filaments; *sep.* septa; *t.* tentacle; *th.* theca. (A and B after Moseley; C and D after Gilbert Bourne.)

body-wall is thus in contact with the theca, which has the relation of a cuticle, and is, in fact, a product of the ectoderm. The free portion of the body-wall is frequently, in the extended state, folded down over the edge of the theca so as to cover its distal portion. The septa alternate with the mesenteries, each lying in the space between the two mesenteries of one couple, and each being invested

by an in-turned portion of the body-wall (*E*, *F*). Thus the septa, which appear at first sight to be internal structures, are really external: they lie altogether outside the enteric cavity, and are in contact throughout with ectoderm.

The ectodermal nature of the entire corallite is further proved by its development. The first part to appear is a ring-shaped deposit of carbonate of lime between the base of the polype and the body to which it adheres: sections show this ring to be formed by the ectoderm cells of the base. The ring is soon converted into a disc, the *basal plate*, from the upper surfaces of which a number of ridges arise, arrayed in a star-like fashion: these are the rudiments

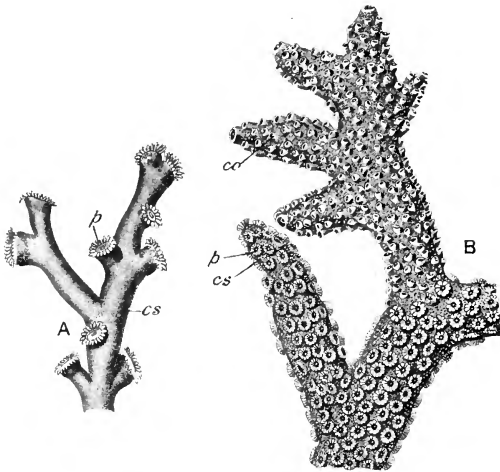

FIG. 157.—*Dendrophyllia nigrescans*, B, *Madrepora aspera*.
co. corallites; *cs.* cænosarc; *p.* polypes. (After Dana.)

of the septa. Here, again, sections show that each septum corresponds with a radial in-pushing of the base, and is formed as a secretion of the invaginated ectoderm. As the septa grow they unite with one another at their outer ends, and thus form the theca. In some cases, however, the theca appears to be an independent structure.

The almost infinite variety in form of the compound corals is due, in the main, to the various methods of budding, a subject which has already been referred to in treating of the actinozoan colony as a whole. According to the mode of budding, massive Corals are produced in which the corallites are in close contact with one another, as in *Astræa* (Fig. 147); or tree-like forms, such

as *Dendrophyllia* (Fig. 157, *A*), in which a common calcareous stem, the *cœnenchyma*, is formed by calcification of the *cœnosarc* (*cs.*), and gives origin to the individual corallites. It is by this last-named method, the *cœnosarc* attaining great dimensions and the individual corallites being small and very numerous, that the most complex of all Corals, the Madreporæ (*Madrepora*, Fig. 157, *B*) are produced.

The microscopic structure of corals presents two main varieties. In what are called the *aporose* or poreless corals, such as *Flabellum*, *Astræa*, &c., the various parts of the corallite are solid and stony, while in the *perforate* forms, such as *Madrepora*, all parts both of the corallites and of the connecting *cœnenchyma* have the characters of a mesh-work, consisting of delicate strands of carbonate of lime united with one another in such a way as to leave interstices, which in the living state are traversed by a network of interlacing tubes, representing the *cœnosarc*, and placing the polypes of the colony in communication.

The Blue Coral (*Heliopora*), one of the Alcyonacea, has a massive corallum of the same general appearance as a Madreporarian. The lobed surface bears apertures of two sizes, the larger being for the exit of the ordinary polypes, the smaller for the siphonozoids. Tabulæ are present, and septum-like ridges, which, however, have no definite relations to the mesenteries and are inconstant in number.

Colour.—The Actinozoa are remarkable for the variety and brilliancy of their colour during life. Everyone must have noticed the vivid and varied tints of Sea-anemones; but most dwellers in temperate regions get into the habit of thinking of Corals as white, and have no conception of their marvellously varied and gorgeous colouring during life. The Madreporæ, for instance, may be pink, yellow, green, brown, or purple; *Tubipora* has green polypes, contrasting strongly with its crimson skeleton; and the effect of the bright red axis of *Corallium* is greatly heightened by its pure white polypes. In *Heliopora* the whole coral is bright blue; the tropical Alcyonidæ are remarkable for their elaborate patterns and gorgeous coloration; and *Pennatula*, in addition to its vivid colours, is phosphorescent.

In most cases the significance of these colours is quite unknown. In some species, however, "yellow cells" or symbiotic Algae have been found in the endoderm, where they probably serve the same purpose as the similar structures which we have already studied in *Radiolaria* (p. 65).

Many Actinozoa, like many sponges (p. 127), furnish examples of **commensalism**, a term used for a mutually beneficial association of two organisms of a less intimate nature than occurs in symbiosis. An interesting example is furnished by various Sea-anemones (Fig. 158) which live on univalve shells inhabited by Hermit-crabs. The Sea-anemone is carried from place to place by the Hermit-crab,

and in this way secures a more varied and abundant food-supply than would fall to its lot if it remained in one place. On the other hand, the Hermit-crab is protected from the attack of predaceous Fishes by retreating into its shell and leaving exposed the Sea-anemone, which, owing to its toughness, and to the pain caused by its poisonous stinging-capsules, is usually avoided as an article of food. Species of *Peachia*, which in the adult state burrow in sand, in a larval condition live as parasites or commensals in the radial canals of Scyphomedusæ.

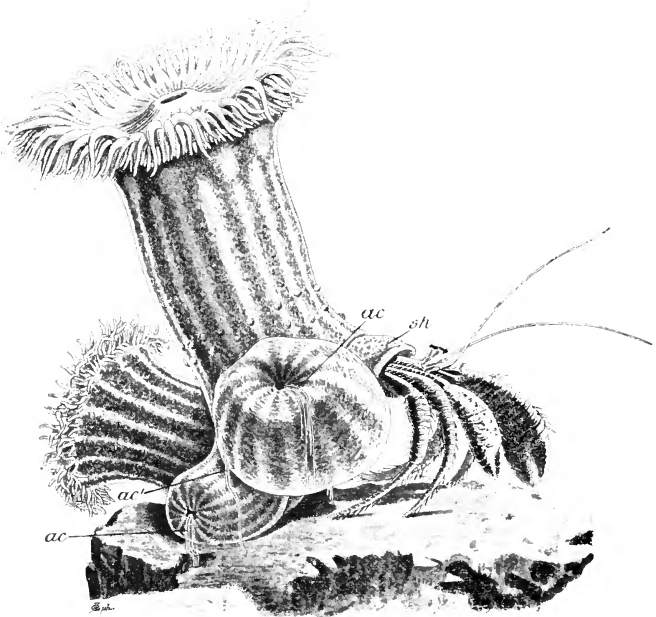

FIG. 158.—*Adamsia palliata*, four individuals attached to a Gastropod shell inhabited by a Hermit-crab. *ac*, *ac*¹, acontia; *sh*, shell of Gastropod. (After Andres.)

Other Sea-anemones—such as the gigantic *Discosoma* of the Great Barrier Reef—are found associated with small Fishes or Crustacea, which have their abode in the enteric cavity. In this case the Fish secures shelter in a place where it is very unlikely to be disturbed, and the two animals are strictly commensals or “mess-mates” since they share a common table. A somewhat similar instance is furnished by the Blue Coral (*Heliopora*), already referred

to more than once. The corallum contains not only the apertures for the polypes and siphonozooids, but also tubular cavities of an intermediate size, in each of which is found a small chætopod Worm, belonging to the genus *Leucodore*. As the polypes are frequently found retracted at a time when the Worms are protruded from their holes in search of food, it is not surprising that the latter should have been credited with the fabrication of the coral. *Trapezia*, a genus of Crabs, always lives in interstices of a particular species of Madrepora.

The **distribution** of the Actinaria is world-wide, and in many cases the same genera are found in widely separated parts of the world. They are, however, larger, and of more varied form and colour in tropical regions, for instance on coral-reefs. The largest reef-anemone, *Discosoma*, found also in the Mediterranean, attains a diameter of 2 feet. Most members of the order are littoral, living either between tide-marks or at slight depths, but a few are pelagic, and several species have been dredged from depths of from 10 to 2,900 fathoms.

The Madreporaria, taken as a whole, have also a wide distribution; but the number of forms in temperate regions is small, and the majority—including the whole of what are called reef-building Corals—are confined to the tropical parts of the Atlantic, Indian, and Pacific Oceans, flourishing only where the lowest winter temperature does not sink below 68° F. (20° C.). Thus their northernmost limits are the Bermudas in the Atlantic, and Southern Japan in the Pacific; their southernmost limits, Rio and St. Helena in the Atlantic, Queensland and Easter Island in the Pacific: in other words, they extend to about 30° on each side of the equator. Moreover, they have a curiously limited bathymetrical distribution, flourishing only from high-water mark down to a depth of about 20 fathoms, but not lower.

Many of the Pacific Islands are formed entirely of coral rock, others are fringed with reefs of the same, and the whole east coast of Northern Queensland is bounded, for a distance of 1,250 miles, by the Great Barrier Reef, a line of coral rock more or less parallel to and at a distance of from 10 to 90 miles from the land. Such reefs consist of gigantic masses of coral rock fringed by living coral, the latter growing upon a basis of dead coral, the interstices of which have been filled up with *débris* of various kinds, so as to convert the whole into a dense limestone.

The Antipatharia and many of the Alcyonaria, such as the Gorgonacea and Pennatulacea, have also a world-wide distribution, and, even in temperate regions, Black Corals and Sea-fans may attain a great size: the members of both these groups, as well as the Sea-pens, are found at moderate depths. The Red Coral is found only in the Mediterranean, at a depth of 10 to 30 fathoms, and at the Cape Verde Islands: other species of *Corallium* occur on the coast

of Japan, at Mauritius and Madeira. Tubipora and Heliopora have the same distribution as the reef-building Corals.

From the palæontological point of view, corals are of great importance: they are known in the fossil condition from the Silurian epoch upwards, and in many formations occur in vast quantities, forming what are called coral limestones. The majority of fossil forms are referable to existing families, but in the Palæozoic era the dominant group was the *Rugosa*, the affinities of which are still very obscure. In these the corallites are usually bilaterally symmetrical, the septa are arranged in multiples of four, and the cup presents on one side a pit, the *fossula*, where the septa are greatly reduced.

CLASS IV.—CTENOPHORA.

1. EXAMPLE OF THE CLASS—*Hormiphora plumosa*.

External Characters.—*Hormiphora* is a pear-shaped organism about 5-20 mm. in diameter, and of glassy transparency (Figs.

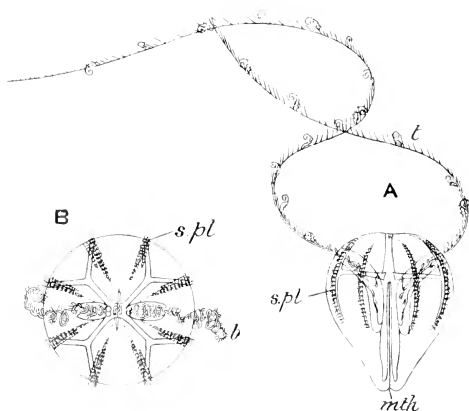

FIG. 159.—*Hormiphora plumosa*. A, from the side, B, from the aboral pole. *mth.* mouth; *s. pl.* swimming plates; *t.* and *b.* tentacles. (After Chun.)

159 and 160). The species *H. plumosa* is found in the Mediterranean; allied forms belonging either to the same genus (often called *Cydlippe*) or to the closely allied genus *Pleurobrachia* are common pelagic forms all over the world.

From opposite sides of the broad end depend two long *tentacles* (*t.*), provided with numerous little tag-like processes, and springing each from a deep cavity or *sheath*, into which it can be completely retracted (Fig. 160, *t.sh.*). At the narrow end—where the stalk of a pear would be inserted—is a slit-like aperture, the *mouth*

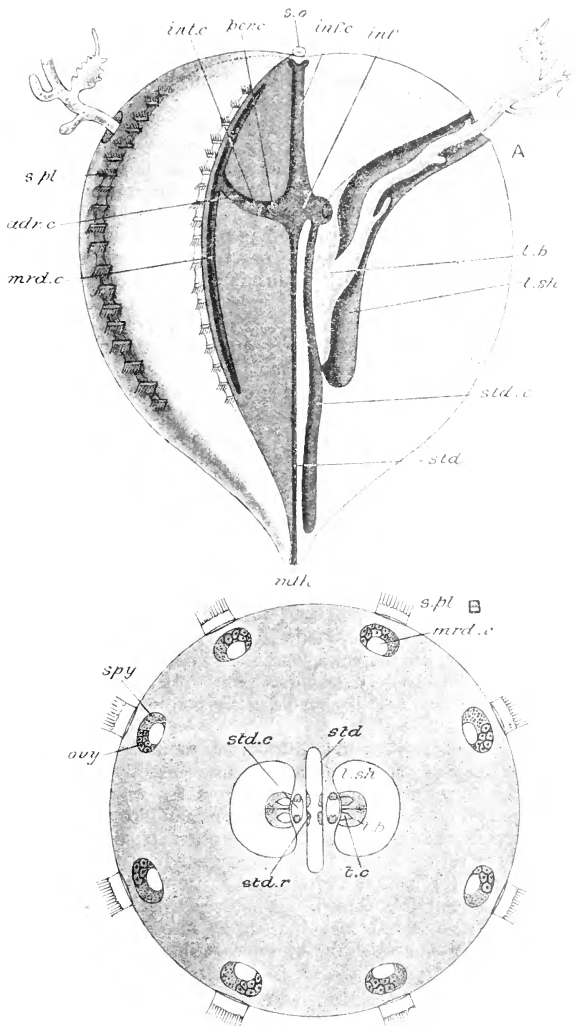

FIG. 160.—*Hormiphora plumosa*. A, dissected specimen having rather more than one quarter of the body cut away. B, section at right angles to long axis (horizontal); diagrammatic, *adr. c.* adradial canal; *inf.* infundibulum; *inf. c.* infundibular canal; *int. c.* inter-radial canal; *mrd. c.* meridional canal; *mth.* mouth; *ov.* ovary; *perc. c.* per-radial canal; *s. o.* sense-organ; *s. pl.* swimming-plate; *spy.* spermary; *std.* stomodaeum; *std. c.* stomodaeal canal; *std. r.* stomodaeal ridges; *t.* tentacle; *t. b.* base of tentacle; *t. c.* tentacular canal; *t. sh.* tentacular sheath.

(*mlh.*): this end is therefore oral. At the opposite or aboral pole is a slight depression, in which lies a prominent *sense-organ* (*s.o.*), to be described hereafter.

But the most striking and characteristic feature in the external structure of Hormiphora is the presence of eight equidistant meridional bands (*s.pl.*), starting from near the aboral pole, and extending about two-thirds of the distance towards the oral pole. Each band is constituted by a row of transversely arranged comb-like structures, consisting of narrow plates frayed at their outer ends. During life the frayed ends are in constant movement, lashing to and fro, and so propelling the animal through the water. The *combs* are, in fact, rows of immense cilia, fused at their proximal ends: their presence and mode of occurrence—arranged in meridional *comb-ribs*, *costæ*, or *swimming-plates*—are strictly characteristic of the class, and indeed give it its name.

It will be seen at once that—apart from all considerations of internal structure—Hormiphora presents a similar combination of radial with bilateral symmetry as in some Hydrozoa, such as Ctenaria (Fig. 110, *I*), and as in the majority of Actinozoa. The swimming-plates are radially arranged, and mark the eight adradia, but the slit-like mouth and the two tentacles indicate a very marked and characteristic bilateral symmetry. An imaginary line passing from the middle of the mouth to the sense-organ is the *primary axis*. A plane passing through the longitudinal axis of the body, parallel with the long axis of the mouth, is called, as in Actinozoa (see p. 188), the *vertical* or *sagittal plane*: it includes two per-radia, which are respectively dorsal and ventral. A plane at right angles to this, passing through both tentacles, and including right and left per-radia, is called the *transverse* or *lateral plane*. It is along these two planes alone that the body is capable of division into approximately equal halves.

Enteric System.—The mouth leads into a flattened tube (Fig. 160, *std.*), often called the stomach, but more correctly the gullet or *stomodæum*. It reaches about two-thirds of the way towards the aboral pole, and its walls are produced internally into ridges (*std.r.*), which increase the area for the absorption of digested food. Living prey is seized by the tentacles, ingested by the aid of the mobile edges of the mouth, and digested in the stomodæum, which is thus physiologically, though not morphologically, a stomach. The products of digestion make their way into the various parts of the canal-system, presently to be described, and indigestible matters are passed out at the mouth.

Towards its upper or aboral end the stomodæum gradually narrows and opens into a cavity called the *infundibulum* (*inf.*), which probably answers to the stomach of an Actinozoon or a medusa, and is flattened in a direction at right angles to the stomodæum—*i.e.* in the transverse plane. From the infundibulum

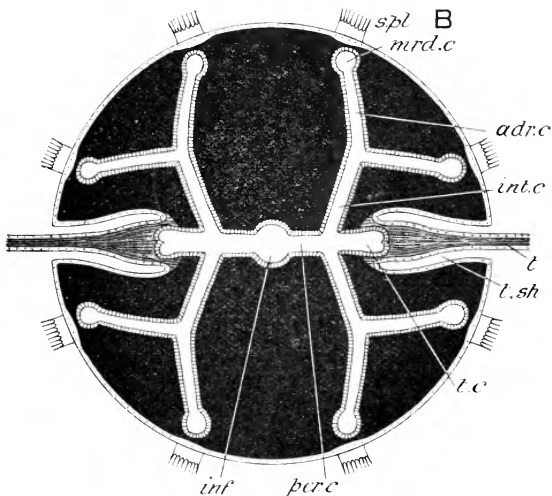
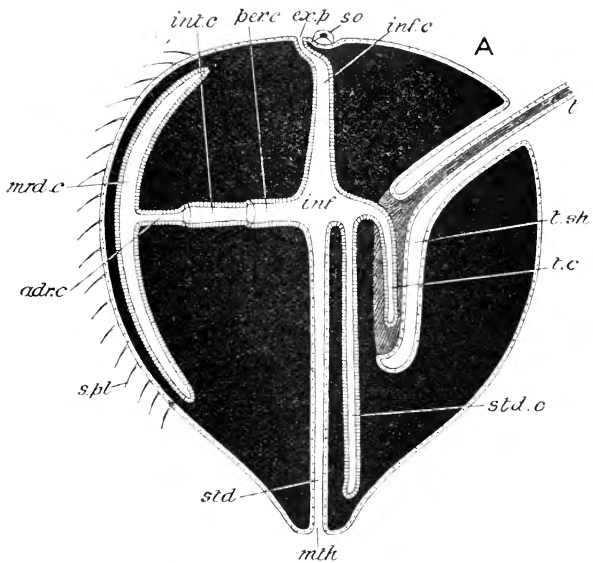
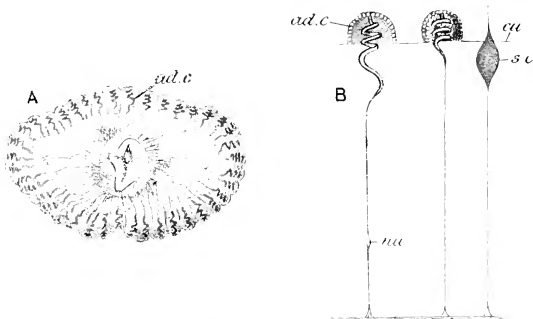

FIG. 161.—*Hormiphora plumosa*, diagrammatic sections: A, through oral axis (longitudinal); B, at right angles to long axis (horizontal). The ectoderm is dotted, the endoderm striated, the mesogloea black, and the muscular axis of the tentacles gray. Lettering as in Fig. 159, except *ex. p.* excretory pore.

three tubes are given off: one, the *infundibular canal* (*inf. c.*), passes directly upwards, and immediately beneath the aboral pole divides into four short branches, two of which open on the exterior by minute apertures, the *excretory pores* (Fig. 161, *A*, *ex. p.*). The two other canals given off from the infundibulum are the *per-radial canals* (*per. c.*): they pass directly outwards, in the transverse plane, and each divides into two *inter-radial canals* (*int. c.*), which in their turn divide each into two *adradial canals* (*adr. c.*). These successive bifurcations of the canal-system all take place in a horizontal plane (Fig. 161, *B*), and each of the ultimate branches or adradial canals opens into a *meridional canal* (*mrd. c.*), which extends upwards and downwards beneath the corresponding swimming-plate. Furthermore, each per-radial canal gives off a *stomodæal canal* (*std. c.*), which passes downwards, parallel to and in close contact with the stomodæum, and a *tentacular canal* (*t. c.*), which extends



162.—*Hormiphora plumosa*. *A*, transverse section of one of the branches of a tentacle; *B*, two adhesive cells (*ad. c.*) and a sensory cell (*s. c.*) highly magnified. *cu*, cuticle; *nu*, nucleus. (After Hertwig and Chun.)

outwards and downwards into the base of the corresponding tentacle. Each tentacle presents a thickened *base* (*t. b.*), closely attached to the wall of the sheath, and giving off a long flexible filament, beset with processes of two kinds—one simple and colourless, the other leaf-like, beset with branchlets, and of a yellow colour.

Cell-layers.—The body is covered externally by a delicate ectodermal epithelium (Fig. 161), the cells from which the combs arise being particularly large. The epithelium of the stomodæum is found by development to be ectodermal, that of the infundibulum and its canals endodermal: both are ciliated. The interval between the external ectoderm and the canal-system is filled by a soft jelly-like mesogloea. The tentacle-sheath is an invagination of the ectoderm, and the tentacle itself is covered by a layer of ectoderm, within which is a core or axis formed by a strong bundle of longi-

tudinal muscular fibres, which, as we shall see (p. 216), are of mesodermal origin, and which serve to retract the tentacle into its sheath.

Delicate muscle-fibres lie beneath the external epithelium and beneath the epithelium of the canal-system, and also traverse the mesoglœa in various directions. The feeble development of the muscular system is, of course, correlated with the fact that the swimming-plates are the main organs of progression, the Ctenophora differing from all other Cœlenterata in retaining cilia as locomotory organs throughout life.

A further striking difference between our present type and the Cœlenterata previously studied is the absence, in Hormiphora, of stinging-capsules. The place of these structures is taken, in a sense, by the peculiar **adhesive-cells** with which the branches of the tentacles are covered. An adhesive-cell (Fig. 162, *ad. c.*) has a convex surface, produced into small papillæ, which readily adheres to any object with which it comes in contact and is with difficulty separated. In the interior of the cell is a spirally coiled filament, the delicate inner end of which can be traced to the muscular axis of the tentacular branch. These spiral threads act as springs, and tend to prevent the adhesive-cells being torn away by the struggles of the captured prey.

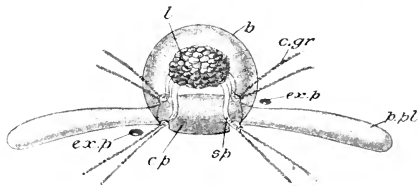

FIG. 163.—*Hormiphora plumosa*, Sense-organ. *b.* bell; *c. p.* ciliated plate; *c. gr.* ciliated groove; *ex. p.* excretory pore; *l.* lithites; *p. pl.* polar plate; *sp.* spring. (Modified from Chun.)

Both the central **nervous system** and the principal **sense-organ** are represented by a peculiar apparatus situated, as already mentioned, at the aboral pole. In this region is a shallow depression (Fig. 163, *c. p.*) lined by ciliated epithelium and produced in the transverse plane into two narrow ciliated areas, the *polar plates* (*p. pl.*). From the depression arise four equidistant groups of very large S-shaped cilia (*sp.*), united to form as many *springs* (*sp.*), which support a mass of calcareous particles (*l.*), like the lithites of Hydrozoa and Scyphozoa. From each spring a *ciliated groove* (*c. gr.*) proceeds outwards, bifurcates, and passes to the two swimming-plates of the corresponding quadrant. The lithitic mass, with its springs, is enclosed in a transparent case or *bell* (*b.*), formed of coalesced cilia. It appears that the whole apparatus acts as a kind of steering-gear, or apparatus for the maintenance of equilibrium. Any inclination of the long axis must cause the calcareous mass to bear more heavily upon one or other of the springs: the stimulus appears to be transmitted by the corresponding ciliated groove to a swimming-plate, and results in a vigorous movement

of the combs. Thus the sensory pit acts as a central nervous system, and the ciliated grooves as nerves. A sub-epithelial plexus of nerve-fibres with nerve-cells extends all over the surface of the body, and nerve-elements are also traceable in the mesogloea.

Reproductive Organs.—The animal is hermaphrodite, the organs of both sexes being found in the same individual. The gonads are developed in the meridional canals (Fig. 160, *B*), each of which has an ovary (*ovy.*) extending along the whole length of one side, a spermary (*spy.*) along the whole length of the opposite side. The organs are so arranged that in adjacent canals those of the same sex face one another. It will be seen that the reproductive products have, as in Scyphozoa and Actinozoa, the position of endoderm-cells: whether they are developed, in the first instance, from that layer is uncertain. When ripe, the ova and sperms are discharged into the canals, make their way to the infundibulum, thence to the stomodæum, and finally escape by the mouth. Impregnation takes place in the water.

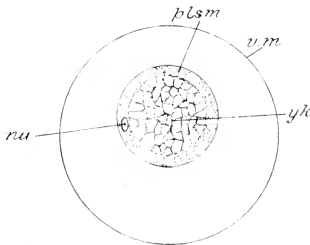

FIG. 164.—Ovum of *Lampetia*. *nu.* nucleus; *plsm.* protoplasm; *v. m.* vitelline membrane; *yk.* yolk. (After Chuu.)

Development.—The process of development has been traced in several genera closely allied to Horniphora, so that there is every reason to believe that, in all essential particulars, the following description will apply to that genus.

The egg (Fig. 164) consists of an outer layer of protoplasm (*plsm.*) containing the nucleus (*nu.*), and of an internal mass of a frothy or vacuolated nature (*yk.*): the vacuoles contain a homogeneous substance which serves as a store of nutriment to the growing embryo, and apparently corresponds with the *yolk* which we shall find to occur in a large proportion of animal eggs. Enclosing the egg is a thin *vitelline membrane* (*v. m.*), separated from the protoplasm by a considerable space, filled with a clear jelly.

After impregnation the oosperm segments, but the details of the process are very different from those we are familiar with in the other Cœlenterata. The protoplasmic layer accumulates on the side which will become dorsal, and the oosperm divides along a vertical plane, forming two cells each with a sort of protoplasmic cap (Fig. 165, *A*, *plsm.*). A second division takes place at right angles to the first, producing a four-celled stage (*B*), and each of the four cells divides again into daughter-cells of unequal size, the result being an eight-celled embryo, each cell with a protoplasmic cap at its dorsal end (*C*, *D*). Next a horizontal division takes place, dividing off the protoplasmic caps as distinct cells, and so

producing a sixteen-celled stage (*E, F*) in which we can distinguish eight large, ventral, yolk-containing cells or *megameres (mg.)*, and eight small, dorsal, protoplasmic cells or *micromeres (mi.)*.

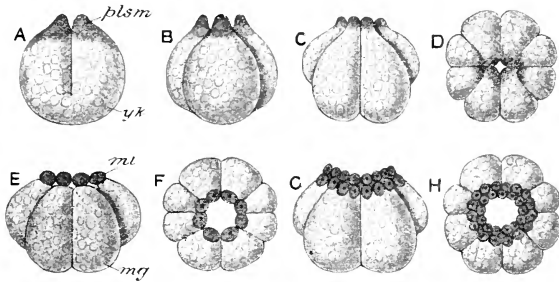

FIG. 165.—Segmentation of the oosperm in *Ctenophora*. *mg.* megameres; *mi.* micromeres *plsm.* protoplasm; *yk.* yolk. (Modified from Korschelt and Heider.)

The micromeres increase rapidly in number by division, and are further added to by new small cells being budded off from the megameres (Fig. 165, *G, H*, and Fig. 166, *A*). The result of this

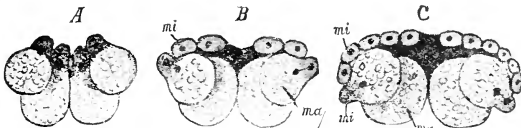

FIG. 166.—Three stages in the development of *Ctenophora*. *ma.* megameres; *mi.* micromeres. (From Lang's *Comparative Anatomy*.)

increase is that the micromeres gradually overspread the megameres (Fig. 166, *C*), the final result being the production of an embryo consisting of a central mass of large yolk-containing cells (*ma.*),

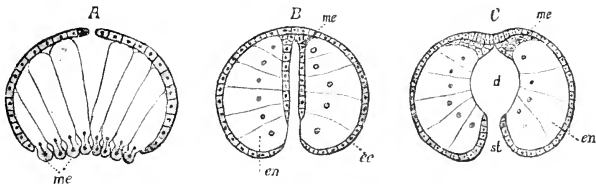

FIG. 167.—Three stages in the development of *Callianira*. *d.* infundibulum; *ec.* ectoderm; *en.* endoderm; *me.* small cells divided off from endoderm; *st.* stomodæum. (From Lang's *Comparative Anatomy*.)

partly surrounded by an epithelium-like layer, incomplete below, of small cells (*mi.*). This stage corresponds with the gastrula of

preceding types, the micromeres forming the ectoderm, the megameres the endoderm, and the ventral edge of the ectodermal investment representing the blastopore. There is, however, no archenteron or gastrula-cavity, and the stage has been produced, not by a process of invagination or tucking-in, but by one of *epiboly* or overgrowth. A gap which is left between the ectoderm cells at the upper (aboral) pole—the *pseudoblastopore*—(Fig. 167, *A*) soon closes up.

The endoderm-cells increase in number, and become much elongated and arranged obliquely, their long axes radiating, upwards and outwards, from the long axis of the entire embryo (Fig. 167, *A*). Their lower (ventral) ends then become divided off, forming a number of small cells (*A. me.*). A kind of invagination and rotation of the megameres then takes place, resulting in the formation of a cavity—the infundibulum (*B, d.*)—bounded below by the megameres, now placed horizontally, and above by the small cells divided off from them. The latter mainly give rise to the tentacular canals. At the same time the ectoderm cells bounding the aperture of the infundibulum grow into it so as to line its ventral portion: in this way the stomodæum (*st.*) is produced. The remainder of the cavity widens out and becomes the definite infundibulum (*d.*), and before long sends off four adradial pouches, the rudiments of the canal-system. At the same time the *mesoderm* (Fig. 168, *me.*), with its gelatinous mesogloea (*g.*), makes its appearance between the ectoderm and endoderm, its cells being derived from ectoderm cells which migrate inwards, chiefly in the neighbourhood of the stomodæum.

FIG. 168.—Two later stages in the development of *Callianira*. *d.* infundibulum; *en.* endoderm; *g.* mesogloea; *me.* mesoderm cells derived from ectoderm; *sk.* sense-organ; *st.* stomodæum; *t.* tentacle. (From Lang's *Comparative Anatomy*.)

The later processes of development may be described very briefly. The canal-system gradually assumes its adult complexity and the swimming-plates appear. A thickening of the ectoderm on each side of the body gives rise to the epithelium of the tentacle and of its pouch. The muscle-fibres forming the axis of the tentacle (*B, me.*) are derived from the mesoderm, which also gives rise to the contractile fibres of the mesogloea (*me₁*). The lithites are formed in the ectoderm cells of the apical pole, but gradually make

their way on to the free surface of the cells, and become supported on four groups of fused cilia. Four outer groups of cilia unite with one another to form the bell (*sk.*).

The most noteworthy points in this somewhat complex process of development are the following:—

1. The distinction between a purely protoplasmic part of the egg and a yolk-containing portion. In the Hydrozoa and Actinozoa the yolk-material is small in amount and evenly distributed, the egg being described as *alecithal* or *microlecithal*. In the present instance the yolk is at first accumulated in the centre of the egg, which is thus *centrolecithal* or mid-yolked, but soon the protoplasm accumulates at one end and the yolk at the opposite end of the developing embryo, producing a *telolecithal* or end-yolked condition.

2. The fact that segmentation is *unequal*, there being a distinction into large cells or megameres, containing yolk, and purely protoplasmic small cells or micromeres.

3. The formation of a peculiar type of gastrula by epiboly or overgrowth, the ectoderm cells (micromeres) growing over and partly enclosing the endoderm cells (megameres).

2. DISTINCTIVE CHARACTERS AND CLASSIFICATION.

The Ctenophora are pelagic Cœlenterata in which the formation of colonies is entirely unknown. No indication of a polype-stage, so characteristic of the remaining Cœlenterata, can be detected either in the adult or in the embryonic condition. Ciliary movement, instead of being a merely embryonic form of locomotion as in the preceding classes, is retained throughout life, the cilia being fused to form comb-like structures, which are arranged in eight meridional rows or swimming-plates (*costæ*). Tentacles, when present, are usually two in number, situated in opposite (right and left) per-radii, and retractile into pouches. The enteron communicates with the exterior by a large stomodæum which functions as the chief digestive cavity. From the enteron is given off a system of canals, the ultimate branches of which are adradial and have a meridional position, lying beneath the swimming-plates; a single axial canal is continued to the aboral pole, where it commonly opens by two excretory pores. There are no gastric filaments. The central nervous system is represented by a ciliated area on the aboral pole, and is connected with a single sensory organ, having the character of a peculiarly modified lithocyst. The gonads of both sexes are lodged in the same individual, the ovaries and testes being formed on opposite sides of the meridional canals. The oosperm undergoes unequal segmentation, the gastrula is formed by epiboly or overgrowth, and a definite mesoderm is established during the gastrula stage. There is no alternation of generations; but in some cases development is accompanied by a well-marked metamorphosis.

The Ctenophora are divisible into five orders as follows:—

ORDER 1.—CYDIPPIDA.

Ctenophora having two tentacles, retractile into sheaths, and unbranched meridional and stomodæal vessels. The body is either circular in section or is slightly compressed in the lateral plane (Figs. 159 and 169).

ORDER 2.—LOBATA.

Ctenophora having numerous non-retractile lateral tentacles contained in a groove: the bases of the two principal tentacles are also present, but have no sheaths. The stomodæal and meridional vessels unite with one another. The body is compressed in the lateral plane, and is produced into two large oral lobes or lappets and into four pointed processes or auricles (Fig. 170).

ORDER 3.—CESTIDA.

Ctenophora having a band-like form, owing to the extreme compression of the body in the sagittal plane. The bases of the two principal tentacles are present, enclosed in sheaths, and there are also numerous lateral tentacles contained in a groove. Union or anastomosis of the meridional and stomodæal vessels takes place (Fig. 171).

ORDER 4.—BEROÏDA.

Ctenophora having no tentacles. The mouth is very wide, and the gullet occupies the greater part of the interior of the body. The meridional vessels are produced into a complex system of anastomosing branches (Fig. 172).

ORDER 5.—PLATYCTENEA.

Flattened Ctenophora of creeping or sessile habit, with a pair of retractile lateral tentacles. The costæ (swimming-plates), when present, are short and deeply sunk. There are no meridional canals; but there is a system of branching peripheral vessels (Figs. 173 and 174).

Systematic Position of the Example.

Hormiphora plumosa is a species of the genus *Hormiphora*, belonging to the family *Pleurobrachiida* and to the order *Cydippida*.

The presence of two tentacles, retractile into sheaths, and of unbranched meridional canals places it in the order *Cydippida*. In this order there are three families, amongst which the *Pleurobrachiida* are distinguished by the absence of any compression of the body, the transverse section being circular. The genus *Hormi-*

phora is distinguished by having a rounded body somewhat produced at the oral pole, and by the aperture of the tentacle-sheath being on a higher level than the funnel. In the species *plumosa* the stomodæal ridges are of a brown colour, and the leaf-like branchlets of the tentacles yellow.

3. GENERAL ORGANISATION.

Compared with the two former classes of Coelenterates, the Hydrozoa and Actinozoa, the organisation of the Ctenophora, if we leave out of account the Platycyanea, is remarkably uniform. This is due to the fact that nearly all

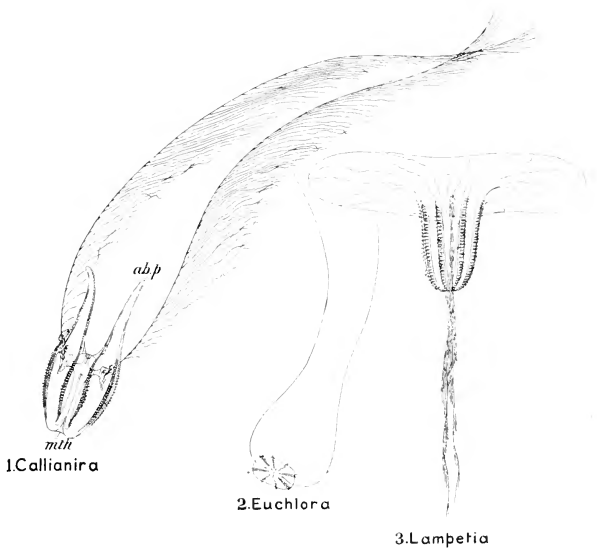

FIG. 169.—Three **Cydippida**. *ab. p.* aboral process; *mth.* mouth. (After Chun.)

the species are pelagic, none are colonial, and none form skeletons. Nevertheless a very great diversity of form is produced in virtue of differences in proportions and of modifications of the tentacular and canal systems.

The *Cydippida* agree in all essential respects with Hormiphora, the most important deviation from the type-form being the compression of the body in the lateral plane in some genera, e.g. *Euchlora* (Fig. 169, 2), the result being an oval instead of a circular transverse section, with the tentacles at the end of the long axis. The aboral pole may be produced into wing-like appendages, as in *Callianira* (1), and in *Lampetia* (3) the mouth is so dilatable as to form, when expanded, a sole-like plate by which the animal retains itself on the surface of the water or creeps over submarine objects.

The *Lobata*, for instance *Deiopea*, are distinguished, as their name implies, by the presence of a pair of large lappets (Fig. 170, *A*, *lp.*), into which the oral surface is produced at either end of the sagittal plane. Four of the swimming plates are shorter than the others, and at their bases arise elongated processes

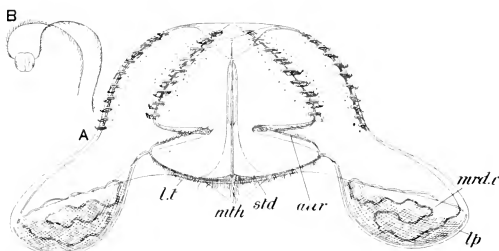

FIG. 170.—*Deiopea kaloknenota*. *A*, adult; *B*, young. *aur.* auricle; *lp.* lappet; *l. t.* lateral tentacles; *mrd. c.* meridional canal; *mth.* mouth. (After Chun.)

called *auricles* (*aur.*), which bear swimming-plates. The meridional canals communicate with the stomodaeal canals, and from the connecting vessels curiously coiled vessels (*mrd. c.*) are given off into the lappets. The principal tentacles are usually absent in the adult, but are represented by their basal portions, which are small, situated at the oral end, and devoid of sheaths. From each tentacle-base grooves are continued along the oral surface to the auricles, and from the grooves depend numerous small lateral tentacles (*l. t.*). In the young condition the *Lobata* resemble such compressed *Cydippida* as *Euchlora*, having a pair of long principal tentacles, no lappets, and unbranched vessels (*B*).

The *Cestida* are represented by the remarkable "Venus's Girdle" (*Cestus veneris*), a band-shaped Ctenophore (Fig. 171) which sometimes attains a length of 1½ metre, or nearly five feet. The body is greatly elongated horizontally in the sagittal, and compressed in the lateral plane, so as to have the form of a ribbon, which progresses by undulations of the whole body as well as by the

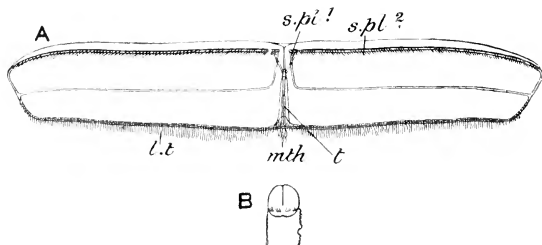

FIG. 171.—*Cestus veneris*. *A*, adult; *B*, young. *l. t.* lateral tentacles; *mth.* mouth; *s. pl.*¹, *s. pl.*², swimming-plates; *t.* tentacle. (After Chun.)

action of its swimming-plates. Four of the swimming-plates (*s. pl.*¹) are very small; the other four (*s. pl.*²) are continued all along the aboral edge of the body. The bases of the two principal tentacles (*t.*) are large and are enclosed in sheaths, and, as in *Lobata*, numerous small lateral tentacles (*l. t.*) spring from grooves which, in the present case, are continued the whole length of the

oral edge. The young of *Cestus* (*B*) resembles a compressed Cydippid which undergoes gradual elongation in the median plane.

Beroë, the principal genus of the *Beroidea*, has the form of a cylinder (Fig. 172), one end of which is rounded and bears the sense-organ, the other truncated and occupied entirely by the immense mouth (*mt*). The greater part of the body is taken up by the huge stomodæum; the infundibulum (*inf.*), per-radial and infundibular canals, &c., all being crowded into a small space at the aboral pole. The meridional canals send off branches which unite with one another, forming a complex network of tubes, and at their oral ends the four meridional canals of each (right and left) side and the corresponding stomodæal canal unite into a horizontal tube, which runs parallel with the margin of the mouth. There is no trace of tentacles either in the adult or in the embryonic condition.

The *Platyctenea* are represented by four genera—*Ctenoplana*, *Cæloplana*, *Tjalfiella* and *Gastrodes*.

Ctenoplana (Fig. 173) is a small marine animal, nearly circular in outline, flattened dorso-ventrally, and about 6 mm. in diameter. It has hitherto been found only twice—once off the west coast of Sumatra and once among the islands to the east of Papua. While able to swim freely, it is able also to creep on its ciliated oral or ventral surface. When it is swimming the animal draws downwards the edges of the disc so that it becomes somewhat helmet-shaped when viewed laterally. The organs of locomotion are eight small, deeply sunk swimming plates. In the centre of the aboral or dorsal surface is a polar body or sense-organ with a statolith, surrounded by a ring of small ciliated tentacles which are disposed bilaterally with reference to the transverse plane, but without polar-plates (ciliated areas). Nerve-centres in the form of several ganglia are situated in close relation to the polar body. The mouth is in the centre of the ventral (oral) surface. There are two pinnate

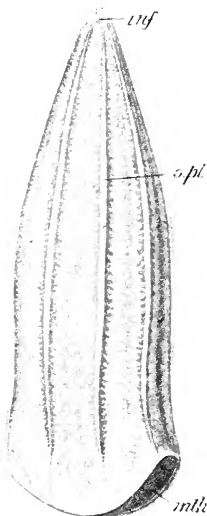

FIG. 172.—*Beroë forskalii*. *inf.*, infundibulum; *mt*, mouth; *s.pl.*, swimming-plates. (After Chun.)

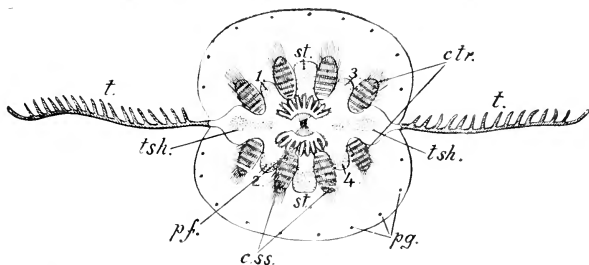

FIG. 173.—*Ctenoplana kowalevskii*, dorsal aspect. *t.*, *t.*, tentacles; *t.sh.*, tentacle sheaths; *ctr.*, subtransverse costæ; *css.*, sub-sagittal costæ; *st.*, "stomach" (? stomodæum), 1, 2, 3, 4, the four principal lobes of the infundibulum; *pf.*, sensory tentacles representing the polar plates; *pg.*, pigment spots. (After Willey.)

retractile tentacles. The canal-system is devoid of meridional canals, but comprises a set of branching and anastomosing peripheral canals. The male gonads only have been found: they are situated in diverticula of the canal system and have been described as having independent ducts opening on the exterior.

Cæloplana has been found in the Red Sea and on the coast of Japan. It is also flattened dorso-ventrally, and further resembles *Ctenoplana* in its ventral mouth, dorsal polar sense-organ with ganglia, paired retractile tentacles, and anastomosing canals. There are, however, no swimming-plates, and progression is effected only by creeping.

Nothing is known of the development of either of these two genera.

Tjaljiella (Fig. 174) was found in dredgings from a depth of 500 metres off West Greenland. Instead of being free and pelagic like the *Ctenophora* in general, or able to creep about like *Cæloplana* and *Ctenoplana*, *Tjaljiella*

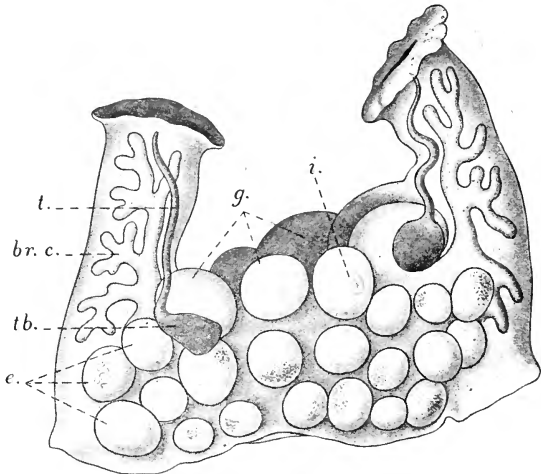

FIG. 174.—*Tjaljiella*. Adult specimen with many embryos, side view; oral (attached) surface upwards. *br. c.* branching canals; *e., g., i.* embryos; *t.* tentacle; *t. b.* tentacle-base. (After Mortensen.)

is sessile in the adult condition, living attached to the stalk or polypes of an Umbellula (Pennatulacea, p. 194). The body is elongated in the transverse plane: shortened in the direction of the primary axis. The attachment is effected by the oral surface by the agency of the inner surfaces of a pair of chimney-like hollow processes, each with a wide distal opening and a ciliated cavity. From the distal opening of each of these processes the corresponding retractile tentacle (*t.*) is capable of being protruded. The slit-like mouth, elongated, as in other *Ctenophora*, in the sagittal plane, opens out of a superficial sub-oral cavity with folded walls with which the cavities of the chimney-like processes are in free communication at their bases—the latter acting as secondary mouths. There are no meridional or stomodæal canals, and in the adult no swimming-plates: the polar (apical) sense-organ is reduced. There are four pairs of reproductive organs, each comprising an ovary and testis arranged opposite one another as in *Horniphora* and the *Ctenophora* in general,

but, in the absence of meridional canals, situated in rounded outgrowths of the per-radial or transverse canal. The inter-radial canals give off lateral branching, but not anastomosing, canals.

Tjalffella differs from all the rest of the Ctenophora in being viviparous. The young, escaping by rupture of the body-wall of the parent from the brood-pouches (apparently in the canal-system) in which they are developed, are provided each with eight swimming-plates and pursue a free existence for a time, subsequently becoming attached and losing the swimming-plates.

Gastrodes, a parasite of *Salpa* (Vol. II.), is probably related to *Ctenoplana* and *Cœloplana*.

[*Bathycytena*, also a deep-sea form, with some resemblances to *Tjalffella*, is more nearly related to the normal Cydippida.]

The Platyctenea are of interest owing to the possibility of their representing an intermediate stage between Cœlenterates (through ordinary Ctenophores) and Platyhelminthes (see Section V.).

The Ctenophora are usually perfectly transparent, and quite colourless, save for delicate tints of red, brown, or yellow in the tentacles and stomodæal ridges. *Cestus* has, however, a delicate violet hue, and when irritated shows a beautiful blue or bluish-green fluorescence. *Beroë* is coloured rose-pink.

Ctenophora are found in all seas from the arctic regions to the tropics. As is to be expected from their perishable nature, there is no trace of the group in the fossil state.

A very remarkable fact has been made out with regard to *Bolina hydatina*, one of the Lobata, a Ctenophore which attains a diameter of 25–40 mm. While still in the larval or cydippid condition and not more than 0.5–2 mm. in diameter, it becomes sexually mature, the gonads producing ripe ova and sperms; and the eggs are impregnated and develop in the usual manner. Soon the gonads degenerate, the larva metamorphoses into the adult form, and a second period of sexual maturity supervenes. This precocious ripening of sex-cells occurs as we shall see in other animal groups, and is called *pædogensis* (p. 42).

THE RELATIONSHIPS OF THE COELENTERATA.

There can be little doubt that the lowest cœlenterate form known to us is the simple hydrozoan polype, represented by *Hydra* and by the hydrula stage of many Hydrozoa. Somewhat more complex in virtue of its stomodæum (if a true stomodæum be indeed represented) and its gastric ridges and filaments is the scyphozoan polype, represented by the scyphula of *Aurelia*. Still more complex is the actinozoan polype, or *actinula*, as it may be called, with its large stomodæum, mesenteries and mesenteric filaments, and elaborate muscular system. Speaking generally, one may say that these three polype-forms represent as many grades of organisation along a single line of descent.

The medusa-form in the Hydrozoa is, as we have seen, readily derived from the hydrula by the widening out of the tentacular region into an umbrella. We may thus conceive of the Trachylinæ,

or hydroid medusæ with no fixed zoophyte stage, as being derived from a pelagic hydrula.

The Leptolinæ may be considered to have arisen in consequence of the adoption of asexual multiplication, by budding, during the larval or hydrula stage. Instead of the hydrula giving rise directly to a medusa, we may suppose it to have formed a temporary colony by budding, after the manner of the Hydra, the individual zooids being ultimately set free as medusæ. The next stage would be the establishment of a division of labour, in virtue of which a certain proportion only of the zooids became medusæ, the rest retaining the polype-form, remaining permanently attached, and serving for the nourishment of the asexual colony.

The Hydrocorallina appear to be a special development of the leptoline stock, the nearest affinities of the order being with such forms as Hydractinia.

The Siphonophora may be conceived as having originated from a hydrula specially modified for pelagic life by the conversion of the basic disc into a float—something after the fashion of *Minyas* (Fig. 153). In such a form extensive budding, accompanied by division of labour, would give rise to the complex siphonophoran colony.

The lowest Scyphozoa are the Lucernarida, some of which, however, show evidence of degeneration, so that it is quite possible to conceive them as having been derived from more highly organised forms, instead of springing directly from simple polypes of the scyphula type. The *Semostomæ*, *Cubomedusæ*, and *Rhizostomæ* clearly represent three grades of increasing complexity along the same general line of descent, the *Coronata* diverging somewhat. It is to be noted, however, that such a supposed line does not lead towards the simpler Actinozoa, but towards a type which diverges from the latter—as well as from the *Lucernarida*, *Cubomedusæ*, and *Peromedusæ*—in the absence of septa or mesenteries in the adult condition.

The close similarity of *Edwardsia* and the *Aleyonaria* in the number and arrangement of the mesenteries seems to indicate the derivation of both *Zoantharia* and *Aleyonaria* from a common ancestor in the form of a simple actinozoan polype or actinula. *Edwardsia* clearly leads us to the *Hexactiniæ* or typical *Sea-anemones*, and the *Madreporaria* are undoubtedly to be looked upon as skeleton-forming *Hexactiniæ*.

The relationships of the *Ctenophora* to the other *Cœlenterata* are very doubtful. *Ctenaria*, one of the *Anthomedusæ* (Fig. 110, I), presents some remarkable resemblances to a *Cydippid*, such as *Hormiphora*. It has two tentacles, situated in opposite per-radial, and each having at its base a deep pouch in the umbrella resembling the sheath of *Hormiphora*. There are eight radial canals formed by the bifurcation of four inter-radial offshoots of the

stomach, and corresponding with them are eight bands of nematocysts diverging from the apex of the ex-umbrella. If these striking resemblances indicate true homologies, we must compare the whole sub-umbrellar cavity of *Ctenaria* with the stomodæum of *Hormiphora*, the margin of the bell of *Ctenaria* with the mouth of *Hormiphora*, and the mouth of *Ctenaria* with the aperture between the stomodæum and the infundibulum of *Hormiphora*. But, as we have seen, the gullet of *Ctenophora* is a true stomodæum developed as an in-pushing of the oral ectoderm, and has therefore a totally different origin from the sub-umbrella of a medusa. Moreover, the tentacles of *Ctenaria* have no muscular base contained in the sheath, but spring from the margin of the umbrella as in other *Hydrozoa*: its gonads are developed in the manubrium, not in the radial canals, and there is no trace of an aboral sense-organ.

In the case of *Hydroctena*, found in Malayan seas, the *Ctenophoran* resemblances, if only superficial, are much more striking. *Hydroctena* (Fig. 175) is bell-like, and provided with a velum (*V.*).

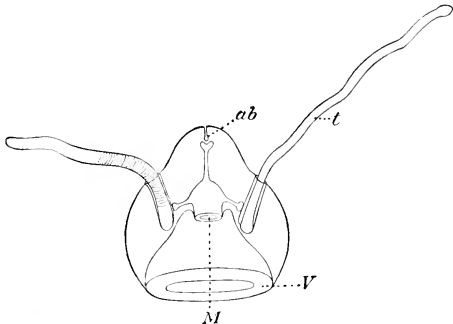

FIG. 175.—*Hydroctena salenskii*. *ab.* aboral sense-organ; *M.* manubrium; *t.* tentacle; *V.* velum. (From the *Cambridge Natural History*, after Dawydoff.)

At its apex is an ampulla (*ab.*) bearing two lithites supported on spring-like processes of the epithelium. From the apex of the gastric cavity a canal is given off which extends to the sense-organ, where it ends blindly, and from the sides a pair of short canals, each of which terminates blindly at the base of the corresponding tentacular sheath. Only two tentacles are present, with sheaths at their bases: these are situated, not on the margin of the bell, as in a medusæ, but between it and the apex. There are no traces of swimming-plates, and, so far as the evidence at present forthcoming goes, there is not sufficient evidence to establish *Ctenophoran* affinities.

On the other hand, the resemblance between transverse sections of an embryo *Ctenophore* (Fig. 176, *B*) and of an embryo *Actinian* (*A*) is very striking, and the presence of a well-developed stomodæum, and of gonads developed in connection with the endoderm and discharging their products through the mouth, may be taken

as further evidences of affinity between the Ctenophora and the Actinozoa.

The special characteristics of the Ctenophora are, however, so numerous and so striking, and their development is so utterly unlike that of any of the other Cœlenterata, that in our present state of knowledge it is impossible to determine their affinity with the other classes with any degree of certainty.

As to the orders of Ctenophora, it seems tolerably clear that both Lobata and Cestida are derived from cydippid forms, since they both pass through, in the course of development, a stage closely resembling the lower Cydippida. The Beroïda are more highly organised in certain respects, *e.g.*, in the details of their histology, than the other Ctenophora, and it seems quite possible

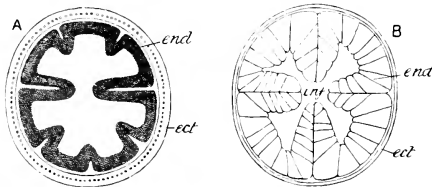

FIG. 176.—Transverse section of embryos of *Actinia* (A) and *Beroë* (B). *ect.* ectoderm; *end.* endoderm; *inf.* infundibulum. (After Chun.)

that they may be derived from tentaculate forms. Whether the Platyctenea are primitive or specially modified remains doubtful; but the latter, in view of the larval develop-

ment of *Tjalfiella*, appears the more probable conclusion.

These relationships are expressed in the diagram on the opposite page.

By many authors the Sponges have been looked upon as so closely related to the Cœlenterata that they may be regarded as members of the same great phylum. The points of resemblance are readily to be recognised: the simple structure, with the large central cavity into which a wide opening—the mouth or the osculum, as the case may be—leads; the absence of a well-developed mesoderm, the fixed mode of life, and associated with it the tendency to form compound structures by a process of budding. In addition, the occurrence of larval stages which have at least a superficial correspondence in the two phyla, would appear to constitute an important connecting link. But a closer examination of the subject shows that some of these apparent points of resemblance are superficial only, and establishes a number of differences between Sponges and Cœlenterates too important to allow us to suppose that a close relationship exists. One of these differences stands out beyond the others as the most radical. The osculum of a sponge is found, when we trace the development of the larva, to correspond in no sense with the mouth of the Cœlenterate. This alone, apart from important differences in the adult structure,

such as the presence in the wall of the Sponge of the system of inhalant apertures, the presence of the peculiar collared endoderm cells, and the absence of stinging-capsules, would suffice to remove the Sponges from the Coelenterata, and place them in a phylum apart. But not only is the grouping of Sponges and Coelenterates in one phylum thus rendered impossible by important differences in their structure and development; a comparison of the mode of formation of the embryonic layers in the two groups shows such

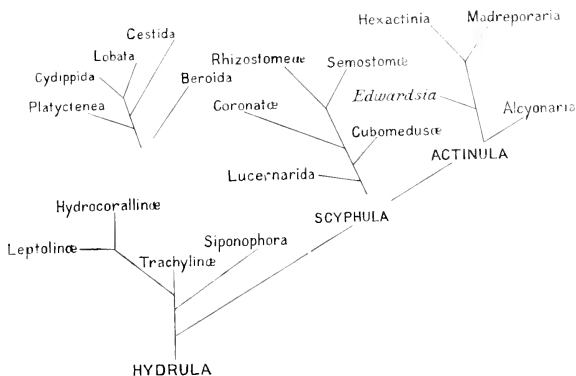

FIG. 177.—Diagram illustrating the mutual relationships of the Coelenterata.

radical dissimilarity that it is scarcely possible to find sufficient evidence for regarding them as having been derived from the same metazoan ancestors, and there is much to be said in favour of the view that they have originated separately from the Protozoa.

APPENDIX TO THE COELENTERATA.

THE MESOZOA.

Under the designation MESOZOA have been comprised certain lowly organised animal forms, formerly supposed to afford us something of the nature of a connecting link between the Protozoa and the Metazoa, but now more generally looked upon as degenerate members of the latter subdivision. It has been proposed to term them the *Moruloidea*, from the resemblance which they bear to the morula stage in embryonic development.

They are all multicellular, with an "ectoderm" composed of a single layer of cells ciliated in whole or in part, and an "endoderm" either composed of a single elongated cell or of several cells: a mesogloea is not represented. The Mesozoa comprise at least three families, the *Dicyemidae*, the *Heterocyemidae*, and the *Orthonectidae*, all the members of which are internal parasites.

The *Dicyemidae* are parasites in the kidneys of various Cuttle-fishes and Octopods (*Cephalopoda*). *Dicyema* (Fig. 178), the length of which is between 0.75 and 6 or 7 millimetres, consists of a head-part or *calotte*, and an elongated

body. The form of the calotte varies a good deal, according to age; in young specimens it is isotropic (*i.e.*, symmetrical around the long axis); in the adult condition ventral and dorsal sides are distinguishable. It consists of a swollen disc of four cells and a ring of four or five *pole cells*. The cells of the head all bear cilia, which are shorter and thicker than those of the body-cells.

The body consists of a single large axial cell, and of a single layer of outer cells which completely invest the axial cell. The outer cells which follow immediately on the head are distinguishable from the rest by their granular contents, and by their being dilated internally in such a way that the apex of the axial cell is constricted.

The axial cell is either almost completely cylindrical or spindle-shaped, and is covered in its entire extent by the outer cells. It presents a differentiated

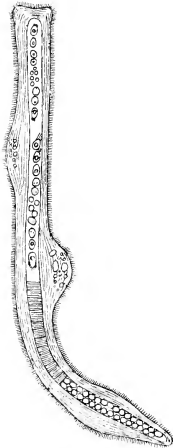

FIG. 178.—*Dicyema paradoxum*, with infusoriform embryos (males). (From Bronn's *Thierreich*, after Kölliker.)

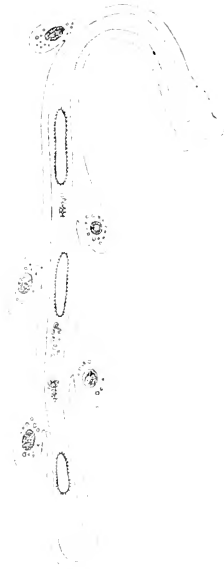

FIG. 179.—*Dicyema paradoxum*, with vermiform embryos. (From Bronn's *Thierreich*, after Kölliker.)

cortical layer, beneath which the finely granular gelatinous contents are at first homogeneous, but afterwards become vacuolated. In the middle of the cell is a large oval or ellipsoidal nucleus.

The life-history is a true alternation of generations. The primitive nucleus of the axial cell divides mitotically to form a smaller asexual germ-nucleus and a larger nucleus—the definitive nucleus (somatic nucleus) of the axial cell. Further germ-nuclei result from subsequent divisions. The germ-cells undergo a process similar to segmentation. Of the cells thus formed one gives rise to the axial cell of the embryo: the others, increasing in numbers and becoming

smaller, gradually grow over the axial cell until they at length completely enclose it. The embryo increases greatly in length, and escapes from the interior of the parent, which it completely resembles, by perforating the body-wall. This phase of the parent animal (Fig. 179) is the phase to which the term *nematogene* is applied: the asexually developed young are the so-called *vermiform embryos*. The latter swim about for a time in the fluid of the kidney of the host; afterwards they attach themselves by means of a head to certain appendages—the venous appendages—of the walls of the cavity. A number of generations of these asexually developed forms succeed one another until, when the venous appendages of the kidney have become thickly infested with the parasites, a change takes place, and a sexual process of multiplication is initiated. In the interior of the *nematogene* a change is observable, and female sexual individuals are formed instead of vermiform embryos. Unlike the latter the former do not leave the body of the parent; they also differ in the non-development of an enclosing layer, the cells representing the latter being converted into ova. In their development, as in that of the vermiform embryos, the nucleus of the axial cell of the female divides into two. One of these becomes the permanent somatic nucleus of the axial cell: the other gives rise to the nucleus of the primitive ovum, and surrounds itself with protoplasm. This divides to give rise to a number of ova, which become more numerous till they come to fill the axial cell. Then the first generation of ova is discharged into the protoplasm of the parent axial cell: this first generation of ova is derived from the cells representing the outer layer. Later, further generations of ova, which are the descendants of the primitive ova, make their escape. These all eventually wander away into the protoplasm of the axial cell of the parent, increase in size, undergo a process of maturation, and become fertilised. Fertilisation is effected by means of typical tailed sperms developed in a second set of sexual individuals, the males (Fig. 180), which were formerly known as the *infusoriform embryos*. In its mature form the male is approximately pear-shaped, the narrower end being posterior. Several axial cells are present: these form the *testes*, in which the sperms are developed. They are surrounded by the outer cells, which at the posterior end take the form of a flat ciliated epithelium. The complete development of the sperms only takes place when the young male leaves the host in which it was formed and seeks a new one; thus it is only by the sperms of a male from another host that the ova can be fertilised. The males are developed from the fertilised ova and subsequently escape, their development being similar to that of the vermiform embryos: the phase of the parent form to which they are developed is that known as the *rhombogene*. After a number of generations of males have been formed in this way, the *rhombogene* undergoes modification, and the last generation of fertilised ova gives rise, not to males, but to vermiform embryos—*i.e.*, to an asexual generation—and with these the cycle begins anew.

The *Heterocyemidæ*, which are also parasites of the Cephalopoda, resemble the Dicyemidæ in most respects, but the head is wanting.

The family *Orthonectidæ* comprises only two genera—*Rhopalura* and *Stæcharthrum*—which live as parasites in a Polyclad (*Leptoplana*), a Nemertine (*Lineus*), an Annelid, and a Brittle-Star (*Amphiura*). In the stage that represents the asexual form of the Dicyemidæ the Orthonectid assumes the character of a plasmodium, or mass of finely granular protoplasm containing many nuclei, and is capable of active amœboid movements. In the interior of the plasmodia the sexual forms are developed. A nucleus of the plasmodium surrounds itself with protoplasm and gives rise to a germ-cell, which by a process of segmentation develops into the sexual stage. In some cases only males are developed in one plasmodium and females in another: in others



FIG. 180.—Male axial cell of *Dicyema paradoxum*. (From Bronn's *Thierreich*, after Kölliker.)

both sexes are formed together in the same plasmodium. In some forms the sexes are united. The sexual animals, especially the females (Fig. 182), bear a considerable resemblance to the Dicyemidæ, but instead of the axial cell there are a number of cells, the ova or sperm-cells. The outer cells are arranged in segments or rings. In front is usually a region composed of a few rings in which the outer cells bear cilia which are directed forwards: then comes a shorter region devoid of cilia, and behind that is the longest region, having cilia directed backwards. In shape the body is usually spindle-like—the males (Fig. 181) differing somewhat from the females. In about the middle of the internal space of the male is the compact oval testis containing small tailed sperms. Beneath the outer layer in the male, but not in the female, is a layer of fibres sometimes regarded as muscular. The plasmodia multiply

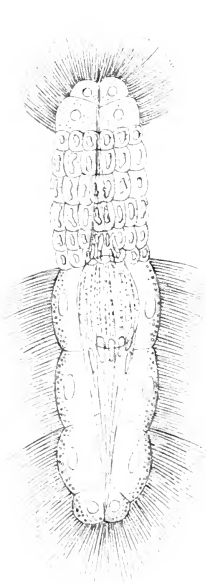

FIG. 181.—*Rhopalura giardii*, male.
(From Bronn's *Thierreich*, after Julin.)

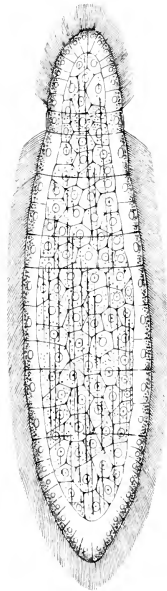

FIG. 182.—*Rhopalura giardi*, female.
(From Bronn's *Thierreich*, after Julin.)

by fragmentation. The development of the embryos either goes on in the intact plasmodium, or the latter breaks up and the embryos are to be found at various stages free in the host.

In the development of a male from the germ-cell the first segmentation is unequal. The further segmentation results in the formation of a solid morula. The outer cells become differentiated into two distinct groups, the one giving rise to the external layer of the anterior region, the other to that of the posterior region of the body. The inner cells multiply and give rise to the numerous small spermatocytes of the testis. The formation of the layer of fibres only takes place later.

In the case of the female the segmentation appears to be equal from the first, and results in the formation of a blastula-like stage, which becomes converted into a solid morula-like body by the passing inwards of a number of cells. As in the male, the central cells multiply to form the sexual cells, and the outer cells form the external layer with its segments. In all probability, though this has not been actually proved, the mature sexual animals become free from the plasmodia, and the females, after fertilisation, find their way to another host where they are transformed into plasmodia, the germ-cells of which are the fertilised ova.

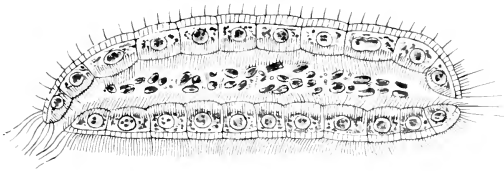

FIG. 183.—*Salinella*, longitudinal section. (After Frenzel.)

To be mentioned also in connection with the Dicyemidæ and Orthonectidæ, as perhaps allied with them, are the remarkable parasites *Amæbophrya* and *Lohmanella*—the former living in certain Radiolarians (*Protozoa*), the latter in the body-cavity of a *Fritillaria* (*Urochorda*). These both resemble the groups described above, and differ from the other Metazoa, in the presence of only a single body-layer. This remarkable simplicity of body-structure occurs also in *Salinella*, though too little is known with regard to this animal to provide adequate data for determining its affinities with certainty.

Salinella (Figs. 183 and 184), which has only been found in artificial saline solutions, is a minute animal in the form of a somewhat depressed cylinder, open at both ends, and with a wall composed of a single layer of cells. The anterior end is somewhat pointed; around the anterior opening or *mouth*, which is ventrally directed, is a cirlet of from fifteen to twenty long whip-like cilia. The posterior aperture (*anus*), which is usually closed, is surrounded by a few stiff setæ. The ventral surface is flattened, and is covered with fine vibratile cilia, while on the dorsal surface and the sides are regularly arranged rows of straight "setæ" (non-motile cilia). The internal cavity (*enteron*) is found to contain sand, plant-fragments, and Bacteria; its surface is beset with long cilia. Multiplication is said to take place by transverse fission; and a process of conjugation followed by encystation has also been observed.

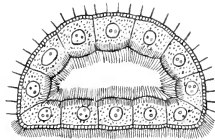

FIG. 184.—*Salinella*, transverse section. (After Frenzel.)

Trichoplax and *Treptoplax*, which have been supposed to be Mesozoa, appear to be merely special modifications of developmental phases of *Hydrozoa*.

SECTION V

PHYLUM PLATYHELMINTHES

A NUMBER of classes of Metazoa, some a little, others very decidedly, higher in organisation than the Cœlenterata, were formerly regarded as constituting one great sub-kingdom or phylum—the *Vermes* or Worms. The groups ordinarily referred to the *Vermes* differ, however, very widely from one another: points of agreement, except such as are merely negative, are, in fact, frequently hardly recognisable: and rather than group together under one common designation such a heterogeneous assemblage of forms, it is usually considered to be more expedient to avoid the term *Vermes* altogether, and to endeavour to divide the “Worms” into phyla the members of which shall have points of positive resemblance to one another. The five phyla *Platyhelminthes*, *Nemathelminthes*, *Trochelminthes*, *Molluscoida*, and *Annulata*, with their appendices, all consist of forms which are or have been comprised in the *Vermes*. They differ from the Cœlenterata in the presence of three well-developed body-layers—of which the middle one, or mesoderm, is of relatively predominant importance; and for the most part, in the much higher stage of complexity attained by the various systems of organs. The first four phyla present no metameric segmentation (p. 43): in the *Annulata*, metamerism is more or less strongly pronounced.

The *Platyhelminthes* or Flat-Worms are a group of soft-bodied, bilateral, usually flattened animals, which are devoid of true metameric segmentation. With a sufficient degree of uniformity of structure to render the phylum a fairly compact and well-defined one, there is yet a considerable range in complexity, from the simplest forms—certain of which have been supposed to be nearly connected with the Ctenophora among the Cœlenterata—to the highest, which have all the various systems of organs very much more highly developed. The body is built up from three embryonic layers—*ectoderm*, *mesoderm*, and *endoderm*—as in all higher groups of animals. An excretory vascular system of a peculiar kind—the *water-vascular* or *protonephridial system*—is

present in nearly all members of the phylum. A body-cavity (see following Sections) is not present, the spaces between the various organs and the wall of the body being filled up with a peculiar form of connective-tissue termed the *parenchyma*. The egg is in most instances composite, the egg-shell enclosing not only the oosperm or impregnated ovum, but a quantity of nutrient material or *food-yolk*, derived, in most instances, from a special set of glands, the *yolk* or *vitelline glands*.

The main features which distinguish the Platyhelminthes from the Cœlenterata are the pronounced bilateral symmetry with the many secondary features which it involves, the presence of a middle embryonic layer or mesoderm, and the non-occurrence of fixed colonies formed by budding.

1. EXAMPLES OF THE PHYLUM.

i. A Fresh-water Triclad (*Planaria* or *Dendrocoelum*).¹

General Features.—Species of fresh-water Planarians of the genera *Planaria* and *Dendrocoelum* are common in the mud at the bottom of ponds of fresh water in all quarters of the globe. They are small, thin, flattened worms a few millimetres in length, broader at one end, the *anterior*, than at the other, the *posterior*, which is more or less pointed. The animal (Figs. 185–187) is very readily recognised to be *bilaterally symmetrical*, with an *upper* or *dorsal* and a *lower* or *ventral* surface, *right* and *left* borders, and *anterior* and *posterior* ends. The colour varies in different species and in different individuals, but is usually gray, red, brown, or black. Movements of locomotion in the direction of the long axis of the body are recognisable in the living animal. Sometimes this is a steady gliding movement, which is brought about by the action of a coating of vibratile cilia on the surface; sometimes the worm moves along somewhat after the fashion of a Leech, the ventral surface of the anterior end of the body being of a sticky adhesive character, and performing the part of the anterior sucker of the Leech.

Close to the anterior extremity on the dorsal surface are two rounded black spots, the *eyes* (Fig. 186). On the ventral surface, a considerable distance behind the middle of the body, is the opening of the *mouth* (Fig. 185, *mo.*), and further back still, near the posterior pointed end, is a smaller median opening, the *genital aperture* (Fig. 187).

Digestive System.—The mouth (Figs. 185, 186, *mo.*) leads through a short mouth-cavity into a cylindrical thick-walled chamber, the *pharynx* (*ph.*), which is highly mobile, and is capable of being

¹ The account is sufficiently general to apply to species of either of these genera.

thrust out as a *proboscis* through the mouth, beyond which it may then be extended to a relatively considerable distance. When retracted it lies within an enclosing muscular *sheath*. The

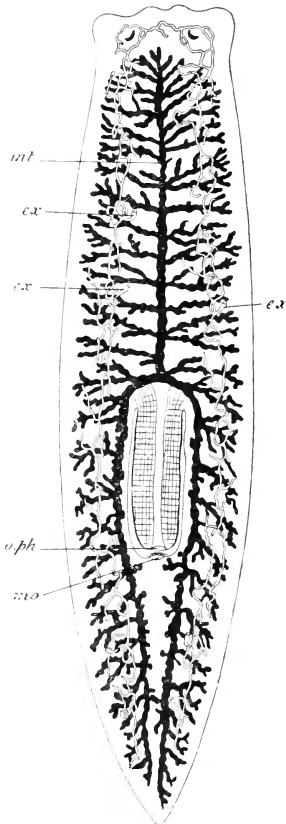

FIG. 185.—**Planaria.** Digestive and excretory systems. *ex.* openings of excretory system; *int.* intestine; *mo.* mouth; *o.ph.* opening of pharynx. (After Jijima and Hatschek.)

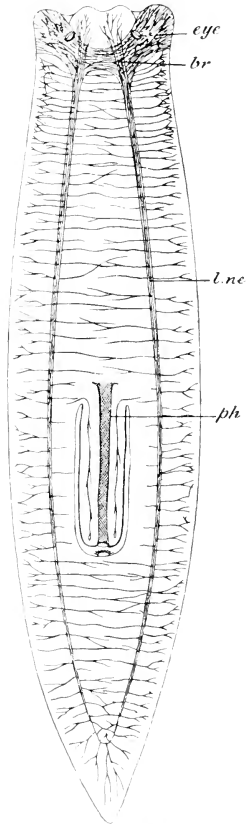

FIG. 186.—**Planaria.** Nervous system. *br.* brain; *eye,* eye; *l. ne.* longitudinal nerve; *ph.* pharynx. (After Jijima and Hatschek.)

cavity of the pharynx opens in front into the *intestine* (*int.*), which almost immediately divides into three narrow main branches, one running forward in the middle line, the other two running back-

wards. Each of these three main branches gives off numerous smaller branches, which in turn become branched, so that the whole intestine forms a ramifying system, extending throughout the greater part of the body; all the branches terminate blindly, an anal aperture being absent.

A system of vessels—the **water-vessels** or vessels of the *excretory system* (*ex.*)—sends ramifications through all parts of the body. There are two main, considerably coiled, pairs of longitudinal trunks, right and left, which open externally on the dorsal surface by means of several pairs of minute pores; in front they are connected together by a transverse vessel. The vessels of each pair often join and separate again. Each main trunk gives origin to a number of branches, which in turn give off a system of extremely fine *capillary vessels*, many of which terminate in *flame-cells* (Fig. 217, p. 264). A flame-cell is a nucleated cell having in its protoplasm a small space into which one of the capillaries leads; in this space lies a bundle of vibratile cilia, or a single thick cilium, which performs regular undulating movements, giving it somewhat the appearance of a flickering candle-flame. Cilia are said also to occur in the course of some of the capillaries, though this is doubtful. This system of vessels is usually regarded as excretory; but it may also have a respiratory function.

A well-developed **nervous system** (Fig. 186) is present. At the anterior end is a central knot of nerve-matter, the *brain* (*br.*), from which proceed backwards two *longitudinal nerve-cords* (*l. ne.*). The brain consists partly of transverse fibres connecting together the two longitudinal nerve-cords, partly of groups of nerve-cells situated at the ends, or in the course of, the nerve-fibres. The nerve-cords give off both internally and externally numerous transverse branches, which divide into finer twigs; the internal branches of the two cords frequently anastomose, thus forming *commissures* or connecting nerve-strands between the two. A number of nerves extend forwards to the anterior margin, which is highly sensitive.

Reproductive System.—The reproductive organs (Fig. 187) are *hermaphrodite* or *monœcious* in their arrangement, both male and female organs occurring in the same individual. The genital aperture leads into a small chamber, the *genital atrium* or *cloaca*, which is common to both the male and the female reproductive systems.

The male part of the apparatus consists of *testes*, *vasa deferentia*, and *penis*. The testes (*tes.*) are numerous rounded bodies, situated near the right and left borders. Two ducts, the right and left *vasa deferentia* (*v.d.*), run backwards from the neighbourhood of the testes and unite in the middle line posteriorly. The median duct formed by the union of the two *vasa deferentia* traverses a protrusible muscular organ, the *penis* (*p.*), to open into the genital

cloaca. At the base of the penis, where the vasa deferentia meet, the median canal is slightly enlarged to form a rounded dilatation, the *vesicula seminalis*. Into the median canal open the narrow ducts of a number of unicellular glands, the *prostate glands* (*pr.*).

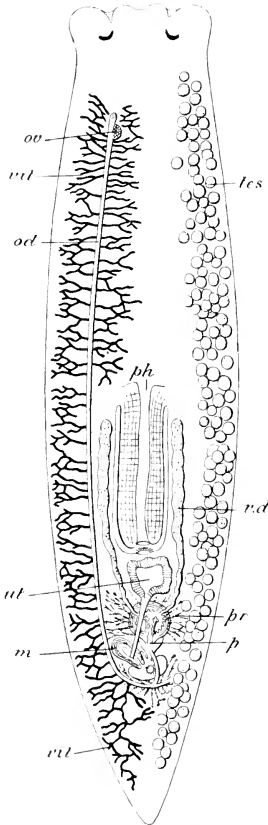

FIG. 187.—**Planaria.** Reproductive system. *m.* muscular sac; *ov.* germarium; *p.* penis; *ph.* pharynx; *pr.* prostate; *tes.* testes; *ut.* uterus; *v. d.* vas deferens; *vit.* vitelline glands. (After Jijima and Hatschek.)

The female part of the reproductive apparatus consists of *ovaries* (*germaria*), *oviducts*, *vitelline glands*, *uterus*, and *muscular sac*. The *germaria* (*ov.*) are two in number—small rounded bodies situated near the anterior end, each connected with an elongated duct, the *oviduct*. The two oviducts (*od.*) unite posteriorly to form a short median *common oviduct* opening into the genital atrium. With this cavity are connected also the *uterus* (*ut.*), a median rounded chamber, and a thick-walled muscular body, the *muscular sac* (*m.*). Numerous branching tubes—the *vitelline glands* (*vit.*)—open into the oviducts.

Reproduction is entirely sexual. The oosperm is enclosed within a protecting case or shell, which contains also a quantity of *food-yolk* derived from the vitelline glands. When the larva has reached a certain stage it develops a temporary larval mouth and gullet (see Fig. 222), and swallows the food-yolk, by the aid of which it grows rapidly. The larval mouth disappears, and a new one—the permanent mouth—is developed in its place. When the embryo leaves the shell, it has assumed the characteristic shape of the parent.

ii. The Liver-Fluke (*Fasciola hepatica*).

General Features.—The Liver-Fluke of the Sheep, which is to be found in the interior of the larger bile-ducts of the infested animal, is a soft-bodied worm of flattened leaf-like shape

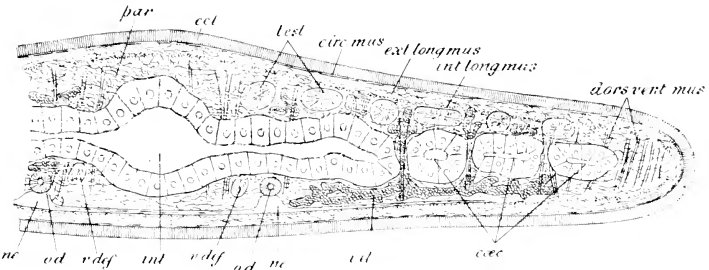

FIG. 188.—Transverse section of a **Planarian**. *circ. mus.* circular muscular fibres; *cac.* in testinal caeca; *dors. vent. mus.* dorso-ventral muscular fibres; *ect.* ectoderm; *ext. long. mus.* external layer of longitudinal muscular fibres; *int.* central lumen of the intestine; *int. long. mus.* internal layer of longitudinal muscular fibres; *ne.* nerve-cords; *o. d.* oviducts; *par.* parenchyma; *test.* testes; *v. def.* vas deferens; *vit.* vitelline glands. (From Hatschek's *Lehrbuch*.)

(Fig. 189), with a triangular process, the *head-lobe*, projecting from the broader end. The symmetry of the parts is distinctly bilateral, as in the Planarian. Externally the body is quite equilateral, the right and left portions exactly balancing one another, but, as will appear subsequently, this complete symmetry does not extend to all the internal organs.

The surface is devoid of vibratile cilia, but is covered with innumerable minute *spinules* or *papillæ*, which are prolongations of the homogeneous external layer or *cuticle* investing the whole animal. At the extreme anterior end of the triangular head-lobe is the small opening of the *mouth* (*mo.*) surrounded by a muscular *oral sucker*. A short distance back on the ventral surface, just behind the head-lobe, is a second much larger *posterior sucker* (*schr.*). Between the two suckers, but rather nearer the posterior one, is a median aperture, the *genital opening* (*repr.*), through which a curved muscular process, the *cirrus* or *penis*, may be protruded. In the middle of the posterior end of the body is a minute opening, the *excretory pore* (*excr.*).



FIG. 189.—**Fasciola hepatica**, natural size. *excr.* excretory pore; *mo.* mouth; *repr.* reproductive aperture; *schr.* posterior sucker.

Body-wall.—The body-wall (Fig. 190) is found on section to comprise three layers:—(1) a homogeneous *cuticle* (*cut.*) of which the spinules (*sp.*) are special developments; (2) a layer of circularly disposed muscular fibres (*circ. mus.*); (3) a layer of longitudinal muscular fibres (*long. mus.*). A cellular epidermis is wanting. Beneath the muscles are numerous *unicellular glands* (*gl.*), the ducts of which, in the form of processes of the cells, open on the

outer surface. Internally, the interspaces between the organs are filled by a peculiar form of connective-tissue, the *parenchyma*.

Digestive System.—The mouth (Fig. 191) leads to a small rounded bulb-like body, the *pharynx* (*ph.*), with thick muscular walls and a small cavity. From this a short passage, the *oesophagus*, opens into the *intestine*. The latter (*int.*) is frequently a very

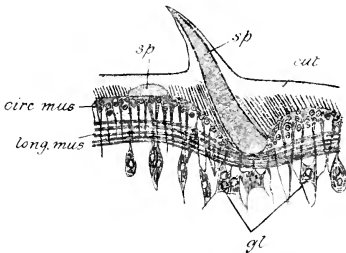

FIG. 190.—**Fasciola hepatica.** Section of the integument. *circ. mus.*, layer of circular muscular fibres; *cut.*, cuticle; *gl.*, unicellular glands; *long. mus.*, layer of longitudinal muscular fibres; *sp.*, spinules. (After Braam.)

conspicuous structure, owing to its being filled with the dark biliary matter mixed with blood on which the Fluke feeds. It divides almost immediately into two main limbs, right and left, and from each of these are given off, both internally and externally, a number of blind branches or *cæca*, those on the inner side being short and simple, while those on the outer side are longer and branched. The two limbs

of the intestine with their branches thus form, as in the Planarian, a complicated system, the ramifications of which extend throughout the whole of the body. There is no aperture of communication between the intestine and the exterior, the only external opening of the alimentary system being through the mouth.

A branching system of vessels—the **water-vessels** or vessels of the **excretory system**—ramify throughout the body. A longitudinal *main trunk* opens behind by means of the excretory pore already mentioned as occurring at the posterior end. In front it gives off four large trunks, each of which branches repeatedly, the branches giving off smaller vessels, and these again still smaller twigs, until we reach a system of extremely fine microscopic vessels or *capillaries*. Each of these ends internally in a slight enlargement situated in the interior of a large cell, an *excretory cell* or *flame-cell*, similar to a flame-cell of the Planarian.

The Liver-Fluke has a well differentiated **nervous system**, which shares in the prevailing bilateral arrangement of the parts. The central part of this system consists of a ring of nerve-matter which surrounds the *oesophagus* and presents two lateral thickenings, or *ganglia*, containing nerve-cells, and a single ganglion in the middle line below. From this are given off a number of nerves, of which the chief are a pair of *lateral cords* running back to the posterior end and giving off numerous branches. There are no organs of special sense.

The reproductive organs (Fig. 191) are constructed on the hermaphrodite plan, *i.e.* both male and female organs occur in the same individual. The male part of the apparatus consists of *testes*, *vasa deferentia*, and *cirrus*. The *testes* (*te.*) are two greatly ramified tubes, which occupy the middle part of the body, one situated behind the other. From each testis there runs forwards

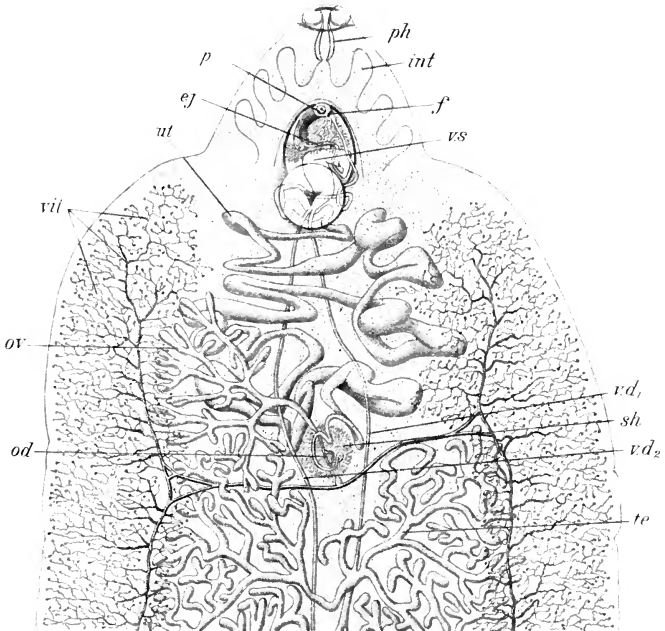

FIG. 191.—*Fasciola hepatica*. Internal organisation. General view of the anterior portion of the body, showing the various systems of organs as seen from the ventral aspect. *ej.* ejaculatory duct; *f.* female reproductive aperture; *int.* anterior portion of the intestine (the rest is not shown); *od.* commencement of oviduct; *ov.* ovary (germarium); *p.* cirrus; *ph.* pharynx; *sh.* shell-gland; *te.* testes; *ut.* uterus; *vd.*₁ left vas deferens; *vd.*₂ right vas deferens; *vil.* lobes of vitelline glands; *vs.* vesicula seminalis. (After Sommer.)

a duct, the *vas deferens*, the two *vasa deferentia* (*v.d.*) opening anteriorly into an elongated sac, the *vesicula seminalis* (*v.s.*), from which a narrow tube—the *ejaculatory duct* (Fig. 192, *ej.*)—leads to the male aperture at the extremity of the cirrus. The female part of the reproductive apparatus consists of a single *ovary* (*germarium*), an *oviduct*, a *uterus*, an *ootype*, *vitelline glands*, *vitelline ducts*, and “*shell-glands*.” The *germarium* (Fig. 191, *ov.*) is a

branched tube situated on the right-hand side in front of the testes; the branches open into a common narrow tube, [the oviduct (*od.*). The vitelline glands (*vit.*) consist of very numerous, minute, rounded follicles, which occupy a considerable zone in

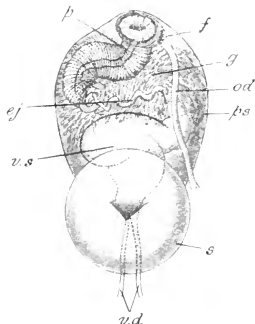

FIG. 192.—*Fasciola hepatica*. Terminal part of the reproductive apparatus. *ej.*, ejaculatory duct; *f.*, female aperture; *g.*, unicellular glands; *od.*, terminal part of oviduct (uterus); *p.*, cirrus; *ps.*, cirrus-sheath; *s.*, sucker; *v. d.*, vasa deferentia; *v. s.*, vesicula seminalis. (After Sommer.)

the lateral regions of the body. On each side are two large ducts, anterior and posterior, uniting to form a single main lateral duct, right or left; and these run nearly transversely inwards to open into a small sac, the *yolk reservoir*. From this a single median vitelline duct runs forwards for a short distance to join the oviduct. Around the junction are grouped a mass of unicellular *shell-glands* or *accessory female glands* (*sh. gl.*), each of which is produced into a narrow process or duct opening into the end of the oviduct in the region of the latter to which the term *ootype* is applied. The *uterus* (*ut.*) is a wide convoluted tube, formed by the union of the oviduct and median vitelline duct; in front it opens close to the base of the cirrus.

When the cirrus is withdrawn, a small cavity, the *genital atrium* or *cloaca*, is formed common to the external apertures of both male and female ducts. A canal, termed the *canal of Laurer*, leads from the junction of the oviduct and median vitelline duct to open externally on the dorsal surface.

Development.—Each ovum on impregnation is surrounded by a mass of vitelline matter or *yolk* derived from the *yolk-glands*. It then becomes enclosed, while passing through the ootype, in a chitinous shell, the substance of which is usually said to be derived from the shell-glands.¹ The completed egg remains for a little time in the uterus; eventually it is discharged, and, passing down the bile-ducts of the Sheep into the intestine, reaches the exterior with the fæces. Active development only begins at this stage, and, three to six weeks later, a portion of the egg-shell at one end becomes separated off as a sort of lid or *operculum*, and gives exit to the contained embryo. This, the *ciliated embryo* or *miracidium* (Fig. 193, *A*), is a somewhat conical body covered all over with vibratile cilia, and with two spots of pigment, the *eye-spots* (*eye*), near the broader or anterior

¹ The agency of the shell-glands in producing the material of the egg-shell is not universally acknowledged. This point will be referred to in the section dealing with the general organisation.

end, which is provided with a triangular head-lobe (*pap.*). There is an imperfectly developed intestine, and a pair of flame-cells, each with a fine canal opening on the surface. The rest of the interior is filled with a mass of germ-cells. The ciliated larva swims about in water, or moves over damp herbage for a time, and perishes unless it happens to reach a water-snail, (species of *Lymnæus*, or of *Bulinus* or *Planorbis*), as a parasite of which it is alone able to enter upon the next phase in its life-history. When it meets with the Snail, the embryo bores into it by means of

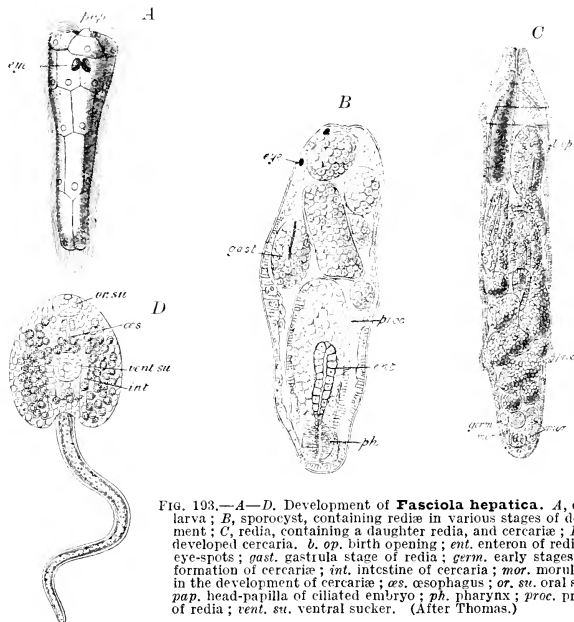

FIG. 193.—A—D. Development of *Fasciola hepatica*. A, ciliated larva; B, sporocyst, containing rediæ in various stages of development; C, redia, containing a daughter redia, and cercariæ; D, fully developed cercaria. *b. op.* birth opening; *ent.* enteron of redia; *eye*, eye-spots; *gast.* gastrula stage of redia; *germ.* early stages in the formation of cercariæ; *int.* intestine of cercaria; *mor.* morula stage in the development of cercariæ; *oes.* œsophagus; *or. su.* oral sucker; *pap.* head-papilla of ciliated embryo; *ph.* pharynx; *proc.* processes of redia; *vent. su.* ventral sucker. (After Thomas.)

the head-lobe, coming to rest in the pulmonary sac or some other organ of the mollusc. Established in the interior of the Snail, it loses its ectoderm and grows rapidly into the form of an elongated sac, the *sporocyst* (Fig. 193, B), with an internal cavity containing germ-cells and lined by a layer of cells, with remnants of the eye-spots, and with flame-cells. The sporocyst may divide into two similar bodies by a process of transverse fission, but this is exceptional. Eventually cells are budded off from the layer that lines the internal cavity of the sporocyst or from the germ-cells, and these

undergo a process of segmentation similar to the holoblastic segmentation of the impregnated ovum, resulting in the formation of a morula, which becomes converted into a stage resembling a gastrula. The gastrula elongates and gives rise

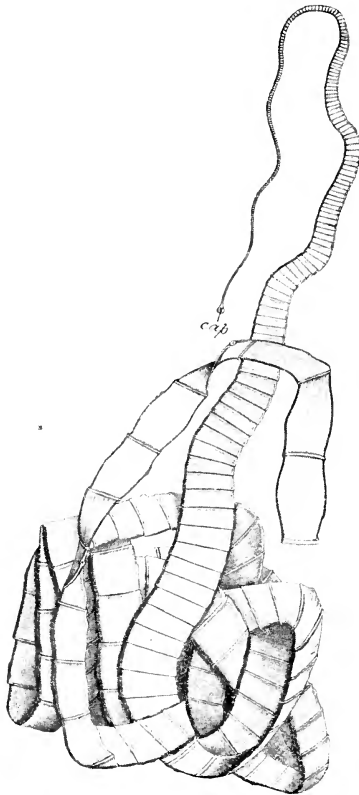

FIG 194.—*Tænia solium*. Entire specimen, reduced; *cap.* head. (After Leuckart.)

to a body called a *redia* (*C*), which begins to move about, and, eventually forcing its way out of the interior of the sporocyst, finds its way to some other part of the Snail, usually the liver. When fully formed, the redia is a cylindrical body with a pair of short processes (*proc.*) near the posterior end, and with a circular ridge near the anterior end. It possesses a mouth leading to a pharynx and simple sac-like intestine, and there is a system of excretory vessels. In the interior of the redia cells are budded off and develop into gastrulæ, exactly as in the case of the sporocyst; these gastrulæ either develop into a fresh generation of rediæ if the season should be winter, or, if it should be summer, give rise to bodies termed *cercariæ*. The latter (*D*) are provided with long tails: they have anterior and posterior suckers, and a mouth and pharynx, followed by a bifid intestine. An opening, the

birth-opening (*C, b. op.*), is formed in the wall of the redia near the circular ridge, and through this the cercariæ escape; they move actively by means of their tails, and force their way out of the body of the Snail. They then, losing the tail, become encysted, attached to blades of grass or leaves of other

herbage. The transference of the larval Fluke in this stage to its final host, the Sheep, is effected if the latter swallow the grass on which the cercaria has become encysted. The young Fluke then escapes from the cyst and forces its way up the bile-ducts to the liver, in which it rapidly grows, and, developing reproductive organs, attains the adult condition.

iii. The Common Tape-Worm of Man (*Tænia solium*).

General Features.—*Tænia solium* occurs as a parasite in the intestine of man. It has the form of a narrow ribbon (Fig. 194), which may attain a length of several yards, attached at one end to the wall of the intestine, the remainder hanging freely in the interior. Towards the attached end the ribbon becomes very much narrower than it is towards the opposite end; and at this narrower extremity is a small, rounded, terminal knob, which is known as the *head* or *scolex*¹; the rest of the animal is termed the *body* or *strobila*; the narrow part immediately behind the head is sometimes called the *neck*. The attachment of the Tape-worm to the wall of the intestine is slight and temporary; it is effected by certain organs of adhesion, the *hooks* and *suckers* on the head.

The *head* (Fig. 195) may be roughly described as pear-shaped, but becomes four-sided at the broader end. In the middle of this broader, anterior end is a rounded prominence, the *rostellum*, round the base of which there is a double row of usually about twenty-eight curved and pointed chitinous hooks. The rostellum is capable of being protruded and retracted to a slight extent, and the position of the hooks varies accordingly: when the rostellum is fully retracted the points of the hooks are directed forwards, and may even meet in the centre; as the rostellum is protruded the hooks become rotated until their apices come to be directed backwards. Four cup-shaped suckers project slightly from the surface behind the circle of hooks.

The *body* or *strobila* has a jointed appearance, owing to its being made up of a string of segments, or *proglottides*—about 850 altogether (cf. p. 510). These are narrower and shorter in front, gradually increasing in size towards the posterior free extremity. The *neck*, or part immediately following the head, is devoid of any trace of segmentation. The two surfaces of the proglottides are not to be distinguished by any differences visible to the unassisted eye;

¹ Though very probable, it is not certain that this end of the Tape-Worm actually corresponds to the anterior end in the Liver-Fluke, as will be explained later.



FIG. 195.—Head of *Tænia solium*, magnified. (After Leuckart.)

but that side towards which the female reproductive organs are more nearly approximated is regarded as the *ventral*, the opposite as the *dorsal* surface. On one border, alternately on the right and left of each proglottis, is a little prominence, the *genital papilla*, on which is the opening of a chamber, the *genital cloaca*, into which both the male and female reproductive ducts open.

An examination of entire living and of preserved and stained Tape-Worms under the microscope shows (1) that an alimentary system is not present; (2) that nervous and excretory systems are represented; (3) that there is a complete set of reproductive organs, constructed on the same general plan as those of the Liver-Fluke, present in each of the proglottides.

The **nervous system** consists of two not very well-defined *ganglia*—united by a broad transverse commissure—in the head; of slender nerves passing from these to the suckers, and of two

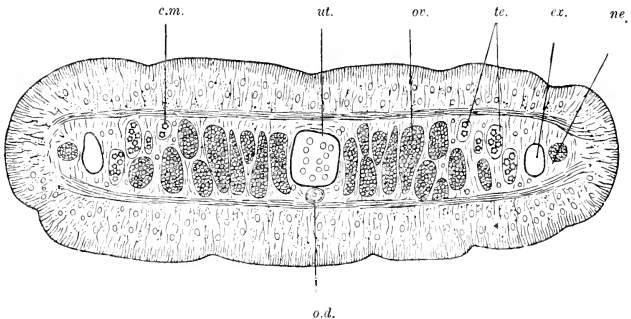

FIG. 196.—Transverse section of *Tænia solium*. *c.m.* circular layer of muscle; *ex.* longitudinal excretory vessel; *ne.* longitudinal nerve; *o.d.* oviduct; *ov.* ovary; *te.* testes; *ut.* uterus. (After Shipley.)

longitudinal nerves which run backwards through all the proglottides to the posterior end of the body. The ganglia seem to correspond to the ganglia on the nerve-ring of the Liver-Fluke.

The **excretory organs** consist of a richly branched system of excretory vessels. There are four *main longitudinal trunks* (Fig. 197, *can. excret.*), two near each lateral margin in the more anterior part of the strobila; in the more posterior region one of these becomes lost on each side. The two pairs of longitudinal vessels are connected together in the head by a ring-like vessel and in each proglottis near its posterior margin by a straight, transverse, connecting branch. Posteriorly the longitudinal trunks open into a pulsatile *caudal vesicle*, communicating with the exterior in the last proglottis. When the latter becomes thrown off, the vesicle is lost with it, and, subsequently, the longitudinal vessels have their separate openings on the exterior. These

main trunks of the excretory system give origin to a number of branches, and these in turn give off numerous fine canalicules, or capillaries, terminating in flame-cells, similar to those of the Fluke.

The **reproductive organs** (Fig. 197), repeated in each fully formed proglottis, are in essential respects very similar to those of the Liver-Fluke. In the most anterior proglottides they are not developed; it is only at about the 200th proglottis that they first appear: at first the male parts of the system are alone differentiated; then in the succeeding proglottides, till we approach near the posterior extremity of the body, the female organs are likewise developed. In the most posterior segments modifications and reductions of some of the parts take place, owing to the great increase in size of the uterus. The male portion of the apparatus consists of the *testes* with their *efferent ducts*, the *vas deferens* (*vas. def.*), and the *cirrus*, with its *sac*.

The *testes* consist of numerous rounded lobes situated nearer the dorsal than the ventral surface, and extending throughout the greater part of the length and breadth of the proglottis. With each lobe is connected a fine *efferent duct*; the ducts of neighbouring lobes unite

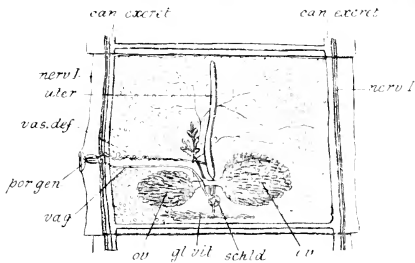

FIG. 197.—A proglottis of *Tænia solium* with mature reproductive apparatus. *can. excret.* longitudinal excretory canals with transverse connecting vessels; *gl. vit.* vitelline glands; *nerv. l.* longitudinal nerves; *ov. ov.* ovaries (germaria); *por. gen.* genital pore; *schld.* shell-glands; *uter.* uterus; *vag.* vagina; *vas. def.* vas deferens. The numerous small round bodies are the lobes of the testes. (After Leuckart.)

together to form somewhat larger ducts; and the larger ducts, receiving numerous tributaries, eventually open into the inner extremity of the *vas deferens*, or main duct of the testis. The *vas deferens* is a convoluted tube which extends outwards towards the lateral margin (right or left as the case may be) of the proglottis.

The terminal part of the *vas deferens*, which is somewhat narrower than the rest, traverses a narrow protrusible process, the *cirrus*, and opens at its extremity by the *male genital aperture* in the genital *atrium* or *cloaca*. The cirrus is enclosed at the base by a muscular sac, the *cirrus-sac*.

The *ovary* (*germarium*) (*ov.*) differs from that of the Liver-Fluke in being a paired organ, consisting of two approximately equal, right and left, halves. It is situated towards the posterior border of the proglottis. Like that of the Liver-Fluke, it consists

of a number of branching tubes, in the interior of which the ova are developed. From opposite sides these tubes converge towards the median line, where they open into the *oviduct*. A *yolk-gland* (*gl. vit.*), of less relative extent than in the Liver-Fluke, consists of a number of minute lobules; a duct, the *yolk-duct*, which runs forward from it, opens into the oviduct. The numerous lobules of a rounded "*shell-gland*" (*schld.*) surround the yolk-duct where it passes forward to join the oviduct; and the many shell-gland ducts open into the oviduct near its junction with the yolk-duct: this part of the oviduct is the *ootype*—the part in which the egg becomes completed. In front this passes into the *uterus*. The female genital pore, situated in the genital atrium, leads into a narrow passage which runs inwards and backwards towards the middle line of the proglottis, where it ends in a dilatation usually filled with sperms—the *receptaculum seminis*. From this a narrow duct—the *fertilising duct* or *spermatic duct*—runs to join the oviduct.

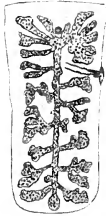

FIG. 198.—"Ripe" proglottis of *Tænia solium*. (After Leuckart.)

The *uterus*, in the segments in which it first makes its appearance, is a simple cylindrical diverticulum of the oviduct; it retains its simple form as far back as about the 600th proglottis, where it begins to branch, the ramifications increasing in extent and volume in the posterior segments. It has no opening on the exterior.

Masses of sperms (probably from the same proglottis) pass in the act of copulation along the vagina to the *receptaculum seminis*; through the fertilising duct they pass to the oviduct to fertilise the ova. As in the case of the Liver-Fluke, the oosperm proper becomes surrounded by a quantity of food-yolk developed in the yolk-glands, and is then enclosed in a firm chitinous shell formed for it by the secretion of the shell-gland. It then passes into the uterus. The first completed eggs are found in the uterus in some proglottis between the 400th and the 500th. From this point backwards they rapidly accumulate, until the cavity of the uterus, which now becomes branched, is filled and distended with them. Eventually in the most posterior, so-called "ripe," proglottides (Fig. 198), the uterus, with its contained accumulation of eggs, becomes so large as to fill the greater part of the interior of the proglottis, the remainder of the reproductive apparatus meanwhile having become absorbed.

Development.—When the ripe proglottides are detached they pass to the exterior with the faeces of the host. For a time they exhibit movements of contraction. The embryos contained within the eggs have meantime assumed the form of rounded bodies, each armed with six chitinous hooks—the *six-hooked* or *hexacanth embryo*

or *proscotex* (Fig. 199, *A*) enclosed within two membranes. If the proglottides, or the eggs which have escaped from them, should now be taken into the alimentary canal of the Pig, which forms the ordinary second host of the parasite, the hooked embryos, becoming freed from their coverings, bore their way with the aid of their hooks through the wall of the alimentary canal, and reach the voluntary muscles. Here they increase greatly in size, and develop into rounded cysts with a large cavity filled with watery fluid (*B*). On the wall of the bladder, at one side, is formed a hollow

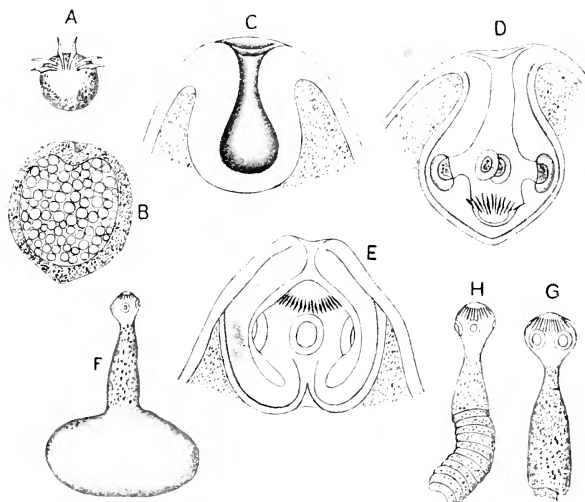

FIG. 199.—Development of **Tapeworm**. *A*, hexacaeth embryo; *B*, early stage of bladder worm of *Taenia saginata*; *C*—*E*, stages in the formation of the scolex of the same; *C*, the invagination before the hooks and suckers have become developed; *D*, after the appearance of the hooks and suckers; *E*, partly evaginated; *F*, fully evaginated scolex of *T. solium* with caudal vesicle; *G*, scolex of *T. serrata* with remains of the vesicle; *H*, young tapeworm of *T. serrata*. (After Leuckart.)

ingrowth, or invagination (*C*); and on the inner surface of this are developed the hooks and suckers characteristic of the head or scolex of the adult (*D*). When these are fully formed the hollow ingrowth becomes everted (*E*), the suckers and hooks thus coming to be situated on the outer surface (*F*). The whole embryo has now the form of a bladder or vesicle, with which is connected at one point a process having all the characters of the head and neck of the mature *Taenia solium*: this is the bladder-worm stage, or *cysticercus*. If a portion of Pig's muscle containing *cysticerci* which have not been killed by cooking is taken into the stomach

of Man, the bladder is thrown off, the scolex attaches itself to the wall of the intestine by its hooks and suckers, and develops the series of proglottides of the adult Tape-Worm.

2. DISTINCTIVE CHARACTERS AND CLASSIFICATION.

The Platyhelminthes are bilaterally symmetrical, usually dorso-ventrally compressed animals, devoid of hard supporting skeleton—either external or internal—and also of metameric segmentation; with three embryonic layers—ectoderm, mesoderm, and endoderm—entering into the formation of the body. A body-cavity is not present. There is a system of excretory vessels, communicating in the majority of cases with the exterior, and furnished with ciliary flames. There is no blood-vascular system. An enteric cavity may be absent, may be rudimentary, or may be highly developed; it is never provided with an anal aperture. The completed egg contains, in addition to the oosperm, a quantity of yolk-matter, usually in the form of definite yolk-cells, and usually produced by a special set of yolk-glands. Development is sometimes direct, sometimes accompanied by a metamorphosis.

CLASS I.—TURBELLARIA.

Mostly non-parasitic Platyhelminthes with a ciliated cellular epidermis; with a digestive cavity.

ORDER 1.—POLYCLADIDA.

Flattened leaf-shaped Turbellaria, without separate yolk-glands; testes and ovaries numerous; male and female genital apertures usually separate; intestine complexly branched.

ORDER 2.—TRICLADIDA.

Turbellaria with elongate depressed body; with numerous yolk-glands, two ovaries, numerous testes; a single genital aperture; intestine consisting of a median anterior division and two lateral posterior limbs which are provided with side branches.

ORDER 3.—RHABDOCELIDA. *incl.* ACCELA.

Comparatively small Turbellaria, with the body usually elongate and cylindrical or compressed; with simple, or nearly simple, sac-like intestine; with or without yolk-glands; with one or two ovaries and two or many testes.

CLASS II.—TREMATODA.

Ecto- or endo-parasitic Platyhelminthes devoid of cilia,¹ or of a cellular epidermis²; with a well-developed digestive apparatus.

¹ Except in certain species of *Tremacocephala*.

² Except in the *Tremacocephala* and *Actinodactyltella*.

ORDER 1.—MONOGENETICA (HETEROCOTYLEA).

Mostly ectoparasitic Trematodes ; with direct development.

ORDER 2.—DIGENETICA (MALACOCOTYLEA).

Endoparasitic Trematodes with complicated life-history.

ORDER 3.—ASPIDOCOTYLEA.

Endoparasitic Trematodes with direct development ; adhesive apparatus in the form of a large sucker, which is divided by septa into compartments, and occupies nearly the entire ventral surface.

ORDER 4.—TEMNOCEPHALEA.

Trematodes with direct development, which live on the outer surface or in the respiratory cavities of various animals—*e.g.*, Crustaceans ; most non-parasitic as regards their nutrition, with organs of adhesion in the form of a simple posterior sucker and a system of anterior or marginal tentacle-like appendages.

CLASS III.—CESTODA.

Endoparasitic Platyhelminthes without cilia and without digestive cavity, the animal consisting in most cases of a rounded head bearing organs of adhesion in the form of suckers and hooks, and an elongated compressed body consisting of a string of similar proglottides, each containing a complete set of hermaphrodite reproductive organs.

ORDER 1.—MONOZOA.

The body not divided into proglottides.

ORDER 2.—POLYZOA (MEROZOA).

The body consisting of head or scolex, and string of proglottides.

Systematic Position of the Examples.

Planaria and *Dendrocœlum* are genera of the family *Planariida* or fresh-water Planarians, which is one of the two families of the order *Tricladida*, differing from the other family, the *Geoplanida* or Land Planarians, mainly in having the body less elongated and more dorso-ventrally compressed.

The genus *Fasciola*, to which the Liver-Fluke belongs, is a member of the family *Distomida* of the Digenetic Trematodes. The *Distomida* are characterised by the following features :—They have a cylindrical or more or less flattened body, always provided with two suckers—the anterior terminal or nearly so, the posterior

ventral and either terminal, or in a varying position on the ventral surface. A pharynx may be present or absent. The intestine is always forked, the limbs simple or branched. The genital pore is ventral, either median or lateral, sometimes at the posterior end. There are two testes, sometimes fused into one, sometimes broken up into more or less numerous follicles, but always provided with only two vasa deferentia. There is a single germarium, not uncommonly lobed or divided up into a number of separate parts. A receptaculum seminis, or a Laurer's canal, or both, are present. The vitelline glands are, in most instances, paired, more or less richly branched, extending towards the lateral borders of the body.

The genus *Fasciola* is a member of the sub-family *Fasciolinæ* of the *Distomidæ*, and this is distinguished from the other sub-families by the following characteristics. The *Fasciolinæ* are broad, leaf-like *Distomidæ*, with the integument spinose or scaly. They have a well-developed pharynx. The intestinal limbs are simple or branched. The genital aperture is median, and situated in front of the posterior sucker. The testes are situated one behind the other, directly or obliquely: they are either simple, divided into lobes, or branched. The ovary is immediately in front of the testes, the uterus in front of the ovary. A Laurer's canal is present. The receptaculum seminis is absent or small. Among the many genera into which this sub-family is now divided the genus *Fasciola* presents the following distinctive features:—The anterior end is distinctly differentiated into a head-lobe; the intestinal limbs have long branched diverticula on the outer side, short on the inner; the gonads are all richly branched; there is no receptaculum seminis.

Tænia solium is one of the many species of the genus *Tænia*, of the family *Tæniadæ*, which is distinguished from the other families of Cestodes by the possession of four suckers, with or without a circlet of hooks, and by the development of well-defined proglottides which become separated off when mature.

3. GENERAL ORGANISATION.

General External Features.—As the name of the phylum denotes, the body in the Platyhelminthes is, in the great majority of cases, much compressed in the dorso-ventral direction; very thin, so that when very short it may be described as leaf-like, or, when more elongated, as ribbon-like; or thickish in the middle and becoming thinner towards the margin. Some, however, have the body comparatively thick, usually with a certain amount of dorso-ventral compression; a few are approximately cylindrical or fusiform. The symmetry is always *bilateral* (p. 43), the radial arrangement of parts so prevalent in the Cœlenterata and primarily, as we have seen, associated with a fixed or stalked

condition, never being observable. A Flat-Worm has dorsal and ventral surfaces, right and left sides or borders, and anterior and posterior ends. The anterior end is that which is directed forwards in ordinary locomotion: it usually has some of the features which distinguish a head-end; but a distinct head is rarely developed, and the mouth, when present, is usually placed some distance back on the ventral surface.

In the *Turbellaria* (Fig. 200) the leaf-form is the prevailing one, a shape resembling that described for *Planaria* being very common. In many, however, the body is greatly elongated, and it may assume the shape of a thin ribbon with puckered edges, as in some marine forms; or may be thickened and band-like, as in the Land Planarians; or it may approach the shape of a cylinder, as in some Rhabdocœles. A head-region is not usually distinct; but there is always something to mark off the anterior from the posterior end—a difference in shape, the presence of eyes, and, sometimes, of a pair of short tentacles; in some a slight constriction separates off an anterior lobe, on which the eyes are borne, from the rest of the body. In others the anterior end is retractile, and may be everted as a proboscis. The mouth is never at the extreme anterior end, but always ventrally placed, sometimes behind the middle. In some Polycladida there is a small ventral sucker, probably with a copulatory function; and in some Rhabdocœles both the anterior

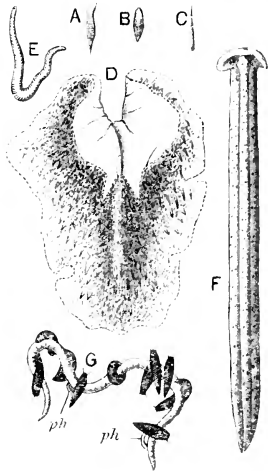

FIG. 200.—Various **Planarians**. A, *Convoluta*; B, *Vortex*; C, *Monotus*; D, *Thysanozoon*; E, *Rhynchodemus*; F, *Bipalium*; G, *Polyoceles*. All natural size. (After Von Graff.)

and posterior ends, though not provided with suckers, are adhesive, so that the animal can loop along like a *Hydra* or a *Caterpillar*. There is never any external appearance of segmentation, though in at least one exceptional instance (*Gunda segmentata*, Fig. 201) the internal parts may be so disposed as to approximate to the metameric arrangement (*pseudo-metamerism*). In such a case a number of transverse muscular septa are present, imperfectly dividing the body internally into a series of segments; and various internal organs—intestinal cæca, gonads, transverse commissures of the nervous system—are arranged in pairs following this division. A few *Turbellaria* multiply by *budding*, and these form long chains, having

something in common with the string of proglottides of a Cestode,

but differing radically, as will be shown later, in the mode of development. Colour is very general in the Turbellarian, though some are transparent and colourless. The most vivid coloration characterises some of the marine Polyclads, the Rhabdocœles being comparatively obscure. The surface is covered with a coating of fine *vibratile cilia*, the vibration of which subserves respiration as well as (in the smaller forms) locomotion. Among the ordinary cilia are frequently disposed longer whip-like cilia or flagella, likewise motile; and sometimes non-motile (sensory) cilia may occur here and there.

The *Trematodes* (Figs. 189, 202, 203, 204), nearly related to the Turbellarians in internal organisation, resemble them also in external form, with certain modifications connected with a parasitic mode of life. As in the latter class, the leaf-shape prevails; an elongated form also occurs, though more rarely. The body is usually thicker and more solid than in most Turbellaria. The anterior end is distinguished from the posterior by

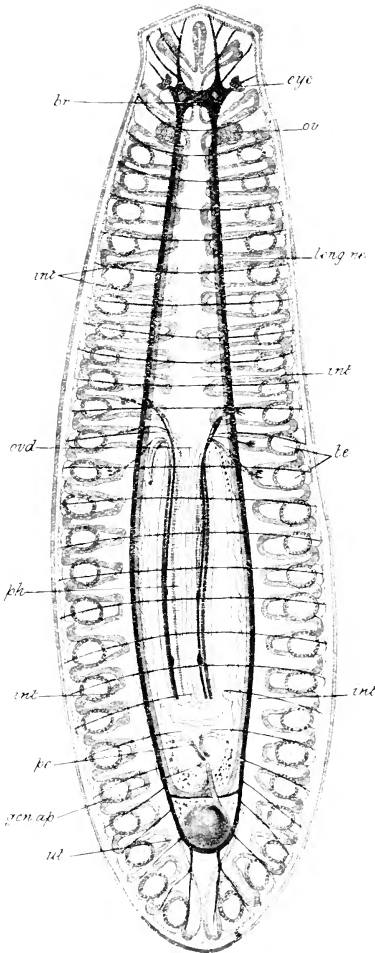

FIG. 201. *Gunda segmentata*. General view of the organisation. *br.*, brain; *eye*, eye; *gen. ap.*, genital aperture; *int.*, intestine with its caeca; *long. n.*, longitudinal nerve-cord; *ov.*, ovary; *ovd.*, oviduct; *pe.*, penis; *ph.*, pharynx; *te.*, testes; *ut.*, uterus. (After Lang.)

its shape, by the arrangement of the suckers, and, in many of those Trematodes that are external parasites, by the presence of eyes. Suckers, present in the Turbellaria only in some of the Polycladida and a few Tricladida, are universal in their occurrence. They are always ventrally placed, their chief function being to fix the parasite to the surface of its host in such a way as to facilitate the taking in by the mouth of animal juices and epithelial débris; their number and arrangement vary considerably. There are nearly always present an anterior set of suckers (or a single anterior sucker surrounding the mouth) and a posterior set, or a single large posterior sucker.

The arrangement already described as characterising the Liver-Fluke is that which is typical in the digenetic forms—a single anterior and a single posterior sucker; but in some of the *Digenetica* the posterior sucker is wanting. Adhesive papillæ on the dorsal or ventral surface may supplement the adhesive action of the suckers (Fig. 202, B). In the Monogenetica the suckers are often more numerous; in the family *Gyrodactylidæ* (Fig. 203, A) there is no anterior sucker, but at the posterior end one or two discs armed with hooks; in the *Polystomeæ* (Fig. 203, B) there is also a posterior disc on which are six suckers with several hooks; in the *Temnocephalea* (Fig. 204) there is no anterior sucker, but the anterior end develops a row (two only in *Scutariella*) of adhesive tentacles, while in *Actinodactylella*

(Fig. 205) a series of marginal tentacles is present in addition to both anterior and posterior suckers. In the *Aspidocotylea* there is only a single sucker; but it extends over nearly the whole of the ventral surface, and is complicated in structure owing to its cavity being divided into a number of compartments by a system of partitions.

Save in two exceptional cases (*Temnocephala*) vibratile cilia are not known to occur on the surface in the adult condition; in some there are groups of non-motile cilia, situated on little conical elevations—the *tactile cones*. Pigment is rare in the endoparasitic *Digenetica*, save in a few that live in the interior of transparent animals; though many appear coloured variously by the internal organs shining through the translucent body-wall, or are stained

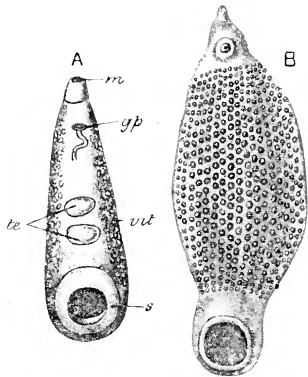

FIG. 202.—Digenetic Trematodes. A, *Amphistomum*; B, *Homalogaster*. g.p. genital aperture; m. mouth; s. posterior sucker; te. testes; vit. vitelline glands. (After M. Braun.)

by some fluid derived from their host. Pigment occurs in some of the ectoparasitic forms.

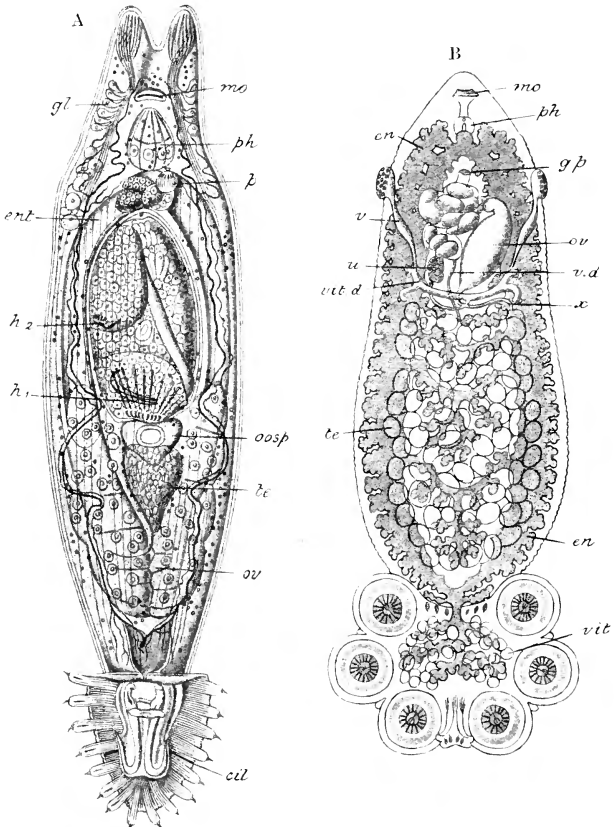

FIG. 203.—**Monogenic Trematodes.** *A*, *Gyrodactylus*. *cil*, disc bearing hooks and processes at the posterior end; *ent*, intestine; *gl*, unicellular glands whose ducts open on the surface about the anterior end; *h*₁, caudal disc of the first embryo; *h*₂, caudal disc of the second embryo; *mo*, mouth; *oosp*, oosperm; *ov*, ovary; *p*, penis; *ph*, pharynx; *te*, testes. *B*, *Polystomum*. *en*, intestine; *g. p.*, genital pore; *mo*, mouth; *ph*, pharynx; *ov*, ovary; *te*, testes; *u*, uterus; *v. d.*, vas deferens; *vit*, vitelline glands; *vit. d.*, vitelline ducts; *x* marks the position of the genito-intestinal canal connecting the oviduct with the intestine. (From M. Braem.)

The relationship of the *Cestoda* to the Trematoda is, as will be subsequently shown, fairly close; but though there are connecting

forms between the two classes, the shape of the average Cestode is very different from that of such an average Trematode as the Liver-Fluke. The body of an ordinary Cestode is of great length—sometimes extending even to a good many feet—and relatively narrow, being compressed into the form of a ribbon. One end,

which it will be convenient to designate anterior (though it may not, perhaps, correspond to the anterior end in a Trematode or a Turbellarian), is, in most cases, attached to the host by means of suckers and hooks placed on a rounded lobe, the *head* or *scolex*, connected with the body by a narrow part or *neck*. The head is usually rather radially than bilaterally symmetrical, with four suckers and a cirlet of hooks. The hooks, when present, are borne on a longer or shorter retractile process, the *rostellum*, the long axis of which is in line with the long axis of the body. In *Bothriocephalus* and allied forms a pair of longitudinal grooves take the place of suckers, and there are no hooks. In many Cestodes parasitic in Fishes the head bears four prominent, thin, folded flaps—the *bothridia*, which are exceedingly mobile, and are used more as creeping organs than as organs of fixation. In relation

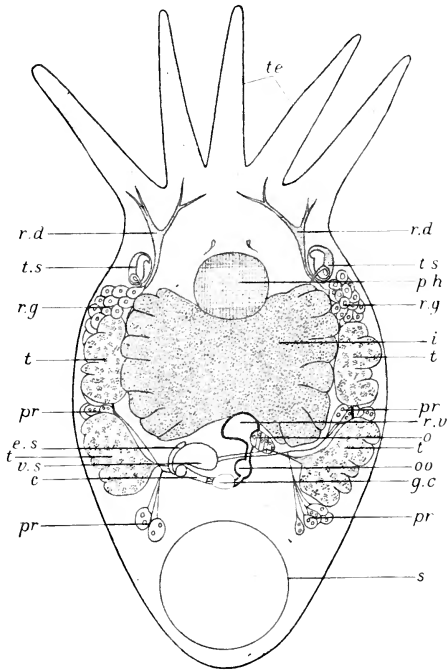

FIG. 204.—*Temnocephala minor*, general view of the organisation. *c.* cirrus; *e. s.* ejaculatory sac; *g. c.* genital atrium; *i.* intestine; *o.* germarium; *oo.* ootype; *ph.* pharynx; *pr.* prostate glands; *r. d.* strands of ducts of integumentary glands running forwards to the tentacles; *r. g.* groups of integumentary (rhabdite-forming) glands; *r. e.* receptaculum; *s.* sucker; *t.* testes; *te.* tentacles; *t. s.* terminal sacs of excretory system; *v. s.* vesicula seminalis.

to the body. In *Bothriocephalus* and allied forms a pair of longitudinal grooves take the place of suckers, and there are no hooks. In many Cestodes parasitic in Fishes the head bears four prominent, thin, folded flaps—the *bothridia*, which are exceedingly mobile, and are used more as creeping organs than as organs of fixation. In relation

to each of these bothridia, which, by coalescence, may appear to be reduced to two, may be a small sucker of the ordinary kind. In *Tetrarhynchus* (Fig. 206) there are four very long and narrow rostellata, or "proboscides," covered with hooklets, and capable of being retracted into sheaths.

The Cestoda are devoid of mouth, and in most of them the genital apertures are marginally placed, so that, externally, there

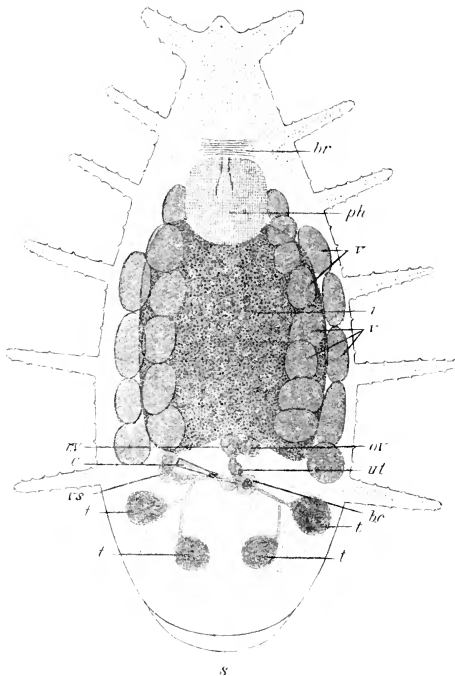

FIG. 205.—*Actinodactylella*. *b. c.* bursa copulatrix; *br.* brain; *c.* penis; *i.* intestine; *or.* ovary; *ph.* pharynx; *r.* receptaculum; *s.* sucker; *t.* testes; *ut.* uterus; *v.* vitelline glands; *v. s.* vesicula seminalis.

is — except in the case of a few in which the genital apertures are not marginal — nothing to distinguish the dorsal surface from the ventral. The body, or strobila, which is narrower in front than it is further back, is made up throughout its length of a series of segments, or proglottides, which become larger and more distinctly marked off from one another as we pass backwards. *Tænia echinococcus* (Fig. 207) is exceptional in possessing only three or four proglottides. In a few (*Ligula* and its allies—

Fig. 208), though the body has the normal elongated ribbon-like form, the segments are not distinct, and in *Caryophyllæus* (Fig. 209), *Amphilina*, *Gyrocotyle* (*Amphiptyches*—Fig. 210), and *Archigetes* (Fig. 211) (which is perhaps merely a young stage of *Caryophyllæus*), segmentation is entirely absent, the whole body in these genera consisting of a single proglottis. The surface in the Cestodes is devoid of cilia, and there is no pigment.

Integument and Muscular Layers.—In the Platyhelminthes in general there are *integumentary* layers and underlying layers of *muscle*, which are more highly differentiated than in the Coelenterates. But considerable differences exist in this respect between the members of the three classes. In the Turbellaria (Fig. 212) there is, as already noticed in the account given of the Planarian, a distinct *epidermis* (*ep.*) in the form of a layer of cells, most of which are ciliated. A delicate *cuticle* is usually, though not always, distinguishable, investing the epidermis externally. In one family the cuticle is developed, along the margin of the body, into a series of chitinous bristles. Among the ordinary epidermal cells there are in the Polycladida numerous cells containing short rod-like bodies—the *rhabdites* (*rh.*); in the other orders of the Turbellaria these rhabdite-forming cells are sunk deeply within the parenchyma, and, in the Rhabdocœla, have very long ducts, formed of processes of the cells, by means of which the rods, together with a viscid matter, reach the exterior at certain points of the surface chiefly around the anterior extremity. The function of these rhabdites is not in all cases certain; they have been supposed to add to the sensitiveness of the parts in which they are situated after the fashion of hairs or nails, or to have a skeletal function. In the Rhabdocœla and Tricladida they undoubtedly aid in adhesion, and probably have the function of assisting in the entanglement and capture of food. In certain of the Turbellaria stinging

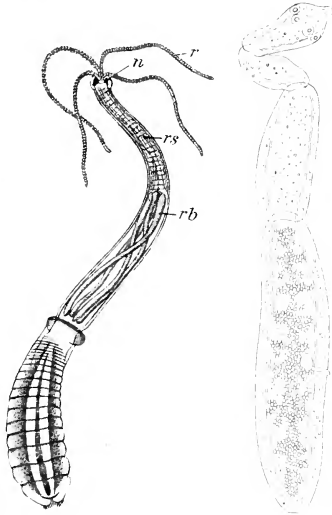

FIG. 206.—**Tetrarhynchus.** *n.* nervous system; *r.* proboscides; *rs.* sheaths, with their muscles (*rb.*). (From Leuckart, after Pintner.)

FIG. 207.—**Tania echinococcus.** (After Cobbold.)

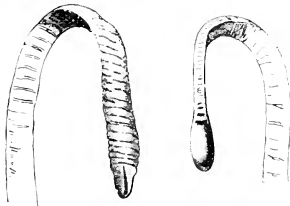

FIG. 208.—**Ligula.** (After Leuckart.)

probably have the function of assisting in the entanglement and capture of food. In certain of the Turbellaria stinging

capsules occur similar to those of the Cœlenterata, but these seem to be derived from *Hydra*, *Cordylophora*, and other Cœlenterates, which form their food. *Adhesive cells* with processes also frequently occur in the epidermis. Beneath the epidermis is a *basement membrane* (*b. m.*), which in the Polycladida is of a thick resistant character, and contains stellate cells.

In a small number of the Trematoda three layers are distinguishable in the integument—a homogeneous, or nearly homo-

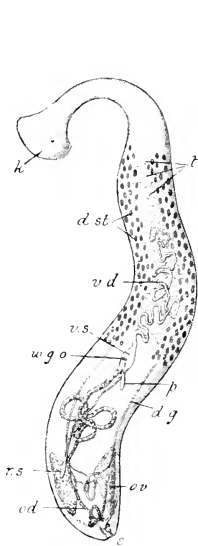

FIG. 209.—*Caryophyllæus*. *d. g.* vitelline duct; *d. st.* vitelline glands; *e.* excretory pore; *k.* mobile organ; *od.* oviduct; *or.* germarium; *p.* cirrus; *r. s.* receptaculum seminis; *t.* lobes of testes; *v. s.* vas deferens; *v. s.* vesicula seminalis; *w. g. o.* female aperture. (After Leuckart.)

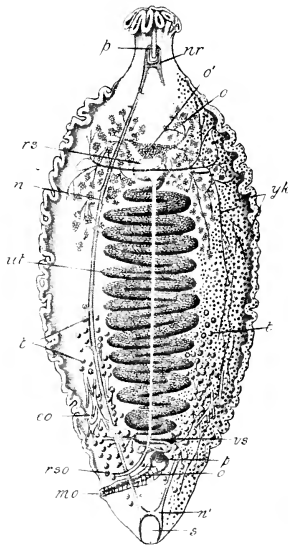

FIG. 210.—*Gyrocotyle* (*Amphiptyches*). *co.* excretory opening; *mo.* male opening; *n.* longitudinal nerve; *n. r.* anterior nerve-ring; *n. r.* posterior nerve-ring; *o.* opening of uterus; *o.* ovary; *o'* receptaculum ovarum; *p.* base of cirrus; *r. s.* receptaculum seminis; *r. s. o.* opening of vagina; *s.* sucker; *t.* testes; *ut.* uterus; *r. s.* vesicula seminalis; *y. k.* vitelline glands. (After Spencer.)



FIG. 211.—*Archigetes*. (After Leuckart.)

geneous, outer *cuticle*; a cellular, or at least nucleated, *epidermis*, and a *basement membrane*; but the cellular epidermal layer is absent as such in the adult condition in the majority of the Trematodes, and there is only a homogeneous, non-nucleated outer layer, which may be the modified epidermis, or may be the cuticle, with or without a basement membrane. *Rhabdite-forming* and other

unicellular glands derived from the epidermis are frequently present beneath the integument.

In the Cestodes, as in the majority of the Trematodes, no definite epidermis is present. The external layer, sometimes divided into two or more strata, is of a homogeneous non-cellular character, and is usually termed *cuticle*. Beneath this is a thin layer of parenchyma, the basal membrane. Beneath this again is a layer of fusiform cells, narrow prolongations of which pass to the cuticle, into the inner part of which they penetrate and spread out into a thin layer. These cells are by some authors regarded as the cells that secrete the cuticle; but they may be concerned in the absorption of nutrient matter, and some of them are undoubtedly of the nature of nerve-cells and have nerve-fibres connected with them.

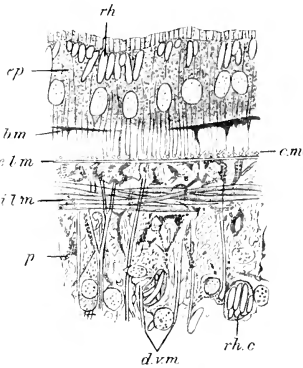

FIG. 212.—Section of the body-wall of a **Triclad**. *b. m.* basement membrane; *c. m.* circular layer of muscle-fibres; *d. v. m.* dorso-ventral layer of muscle-fibres; *e. l. m.* external longitudinal layer of muscle-fibres; *ep.* epidermis; *i. l. m.* internal longitudinal layer of muscle-fibres; *p.* parenchyma; *rh.* rhabdites; *rh. c.* rhabdite-forming cells. (After Jijima.)

The *muscular layers* of the body-wall vary somewhat in their arrangement in the different groups of Platyhelminthes. Most

commonly there are an external layer of circularly arranged and an internal layer of longitudinally arranged fibres; frequently layers of fibres running in a diagonal direction are present also.

Characteristic of the Flat-worms is a peculiar form of connective-tissue, the *parenchyma* (Fig. 213)—mention of which has already been made in the descriptions of the

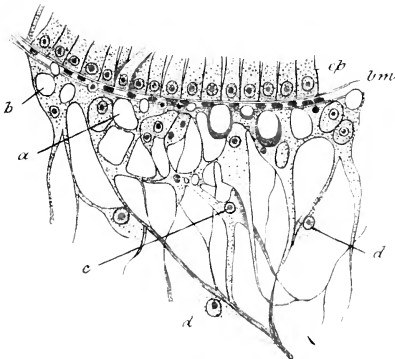

FIG. 213.—Parenchyma of **Distomum**. *a, b.* intercellular spaces; *bm.* basement membrane; *c.* nuclei; *d.* nuclei; *ep.* epidermis. (After Braun.)

examples—presenting many varieties, filling up the interstices between the organs and leaving only, in some instances, very small spaces—sometimes regarded as representing the body-cavity, or *cœlome*, which we shall meet with in other groups of worms. Sometimes the parenchyma appears to consist of distinct large cells with greatly vacuolated protoplasm, with interspaces here and there in which groups of rounded cells are enclosed. Sometimes the constituent cells run together, and the parenchyma then appears as a nucleated, finely fibrillated, vacuolated mass in which the boundaries of the cells are not recognisable. Pigment occurs in the parenchyma in some Rhabdocæle Turbellarians and a few Monogenetic Trematodes. In some Turbellaria—species of *Convoluta* and *Vortex*—the parenchyma contains numerous cells enclosing chlorophyll or xanthophyll corpuscles; these are symbiotic unicellular Algæ, similar in their mode of occurrence to the yellow cells which have been referred to as found in the Radiolaria. Running through the body, for the most part in a dorso-ventral direction, are numerous slender muscular fibres, the fibres of the *parenchyma muscle*; many of these become inserted externally into the basement membrane.

Great differences exist between the various groups of Platyhelminthes as regards the development of the **alimentary system**, differences which are, broadly, to be correlated with differences in the mode of nutrition. Some of the Flat-worms—the Turbellaria and some of the Monogenetic Trematodes—procure their food, in the shape of small living animal or vegetable organisms, or floating organic débris, by their own active efforts. Others—the Digenetic Trematodes and the Cestodes—having reached a favourable situation in the interior of their host, remain relatively or completely passive. An alimentary canal is completely absent in the last-named group, nutrition being effected by the absorption of digested matter from the interior of the animal in which the Cestode lives. In all the rest of the Platyhelminthes there is an alimentary canal, which never opens on the exterior by an anal aperture. All the Turbellaria (except some *Acœla*) and Trematoda have an alimentary apparatus consisting of two well-defined parts—a muscular *pharynx* and an *intestine*. The pharynx is usually a rounded muscular bulb, but is sometimes (some Turbellaria) of a cylindrical shape; it is usually capable of eversion and retraction. *Actinodactylella* (Fig. 205) is exceptional in having, in addition to a large muscular pharynx, an extensile proboscis with a pin-shaped style, which becomes retracted within the opening of the mouth. Unicellular glands open into the pharynx in most cases.

The *mouth* is always ventral, but varies greatly in its position on the ventral surface, being sometimes central, sometimes situated

behind, sometimes in front of, the middle of the length of the body. In the most lowly organised group of Turbellaria (the *Acala*) the intestine is represented merely by a vacuolated, nucleated mass of protoplasm without, or with only an irregular, lumen. In the others

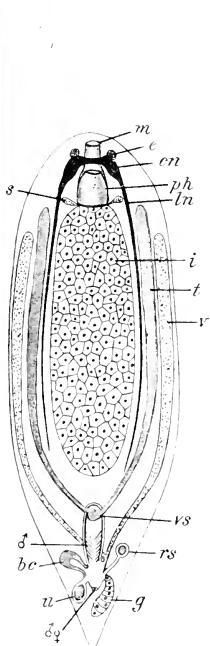

FIG. 214.—General plan of the structure of a **Rhabdocoel Turbellarian**. *bc*. bursa copulatrix; *cn*. brain; *e*. eye; *g*. germarium; *i*. intestine; *ln*. longitudinal nerve; *m*. mouth; *ph*. pharynx; *r.s.* receptaculum; *s*. unicellular glands; *t*. testes; *u*. uterus; *v*. vitellarium; *vs*. vesicula seminalis; ♂ ejaculatory duct; ♂ ♀ common genital aperture. (After Von Graff.)

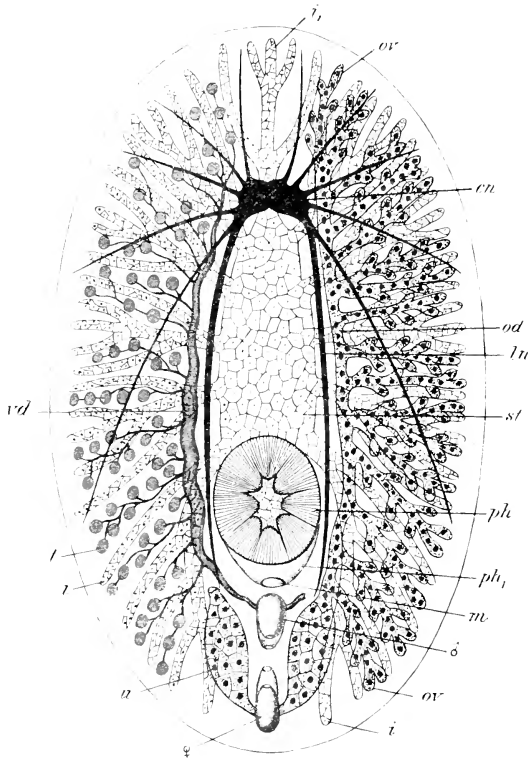

FIG. 215.—General plan of the structure of a **Polyclad**. *cn*. brain; *i*, *st*. intestine; *ln*. longitudinal nerve cord; *m*. mouth; *od*. oviduct; *ov*. ovary; *ph*. pharynx; *ph¹*. sheath of pharynx; *t*. testes; *u*. uterus; *vd*. vas deferens; *rs*. vesicula seminalis; ♂ male aperture; ♀ female aperture. (After Von Graff.)

it is sometimes a simple sac (Rhabdocoel Turbellaria—Fig. 214, a few Trematoda), with or without short lateral diverticula. In the majority of the Trematodes it consists of a pair of simple canals; but in some, as in the Liver-Fluke, there is a pair of canals which

give off numerous branches. In the Polycladida (Fig. 215) there is a central cavity from which numerous branching canals are given off. In the Tricladida (Fig. 216) one median canal passes forwards from the pharynx, and a pair of canals backwards from it, all three giving off branches which again branch. In some *Polycladida* there are minute pores, by means of which certain

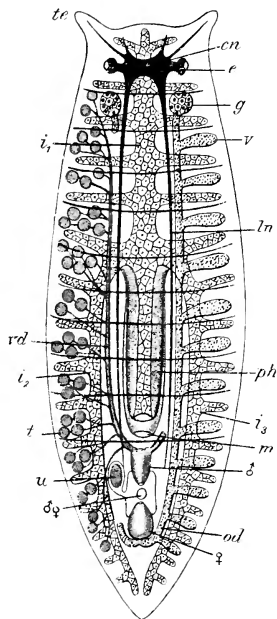

FIG. 216.—General plan of the structure of a **Triclad**. *cn*, brain; *e*, eye; *g*, germarium; *i*, median limb of the intestine; *i*₂, right limb; *i*₃, left limb; *ln*, longitudinal nerve-cord; *m*, mouth; *ol*, oviduct; *ph*, pharynx; *t*, testes; *te*, tentacles; *v*, vitellaria; *vd*, vas deferens; *u*, uterus; *δ*, ejaculatory duct; *♀*, vagina; *δ ♀*, common genital aperture. (After Von Graff.)

of the canals are placed in communication with the exterior. A number of unicellular glands, which probably produce a digestive secretion, open in many Trematodes and Rhabdocœles at the junction of pharynx and intestine.

A bilateral **nervous system** is developed in all the Platyhelminthes. Its elements are *nerve-fibres* and *nerve-cells*. The nerve-cells, which are usually bipolar, more rarely uni- or multi-polar, lie in the course of these fibres, with which the substance of the cells is in continuity. The degree of development of a central part of the nervous system, or *brain*, varies in the different groups; it is best developed in some Polycladida and some Monogenetic Trematodes. It consists of numerous nerve-fibres which here converge from the various parts of the body and pass across from one side to the other, together with a central mass of fine fibrils, and a number of nerve-cells. It is situated in the anterior portion of the body, almost invariably in front of the mouth. Where the peripheral part of the nervous system is best developed, as it is in the Polycladida, the Tricladida, and some Trematodes, there are three pairs of longitudinal

nerve-cords running backwards from the brain throughout the body, connected together by frequent transverse connecting nerves, or *commissures*. To these there are sometimes super-added fine net-works or *plexuses* of nerves, situated superficially under the dorsal integument, or on both dorsal and ventral surfaces. Sometimes nerves run forwards from the brain as well

as backwards. In the Rhabdocœles and some of the Trematodes the whole system is simpler, and the number of longitudinal cords fewer. In the Cestodes there are two principal longitudinal trunks which run throughout the length of the body, and are connected together in the head by commissures, variously thickened to form ganglia representing the brain of other Platyhelminthes.

In addition to the *tactile cones* of some Trematodes and the *sensory cilia* of the Turbellaria, already referred to, the *sensory organs* of the Platyhelminthes are the eyes and the statocysts. *Eyes* occur in the Turbellaria and some Monogenetic Trematodes, but are wanting in the Digenetic Trematodes and in the Cestodes. In some of the Polycladida they are extremely numerous, collected into groups over the brain, and frequently arranged also round the margin of the body. In the Rhabdocœles and Monogenetic Trematodes they are much less numerous—usually two to four. In some cases each eye simply consists of a pigment spot; to this may be added a refractive body. When most highly developed the eye is still of very simple structure, consisting of a cup formed of one or more pigment-cells enclosing refractive bodies (*rods*), and having nerve-cells in close relation to it with processes (nerve-fibres) passing to the brain. The *statocysts* are sacs containing *statoliths* of carbonate of lime. The function of these bodies, which occur only in a small number of the Turbellaria, is unknown; there is no sufficient evidence that they are organs of hearing; it is more likely that they are concerned with the maintenance of equilibrium. Ciliated pits which appear to be sensory are developed in some Rhabdocœles in the head region.

The only **vascular system** present in the Platyhelminthes is the system of *water-vessels* (*protonephridia*) which are commonly regarded as performing an excretory function. The arrangement of these, the mode of ending internally of the finest branches, and the way in which the system communicates with the exterior, vary greatly in the different groups. One or more main *longitudinal trunks* give off branches which subdivide to form a system of minute interlacing branches or *capillaries*. In little spaces at the ends of the capillaries are a number of highly characteristic structures—the *ciliary flames*. Each ciliary flame consists of a bundle of vibratile cilia; typically each is situated in the interior of a cell—the flame-cell (Fig. 217)—terminating one of the capillary branches. But there are some cases in which there are several flames in each flame-cell. The finer branches, and in some cases the larger trunks also, are *intracellular*, and are to be looked upon as perforations in linear rows of elongated cells. In the Cestoda, at least the larger trunks are *intercellular*, being lined by an epithelium of small cells. This system of water-vessels opens on the exterior in a variety of different ways: sometimes it opens by a number of minute pores; sometimes, as in the Liver-Fluke, there is a

single posterior aperture; frequently there are two. In the Tricladida there are two longitudinal canals which open on the exterior through special branches by a series of pores. In the Rhabdocœlida there are either two longitudinal main vessels or a single median one; the communication with the exterior in the former case may be by a pair of ventral apertures, or indirectly through the pharynx; or there may be a common short passage in which the two trunks unite, opening by a posterior median aperture. When a single main trunk is present it opens at the posterior end of the body. In the Trematodes there are usually two principal longitudinal trunks, which either unite behind to open at the posterior end of the body, or (Monogenetica) remain separate and open independently on the dorsal surface, each having, where it opens,

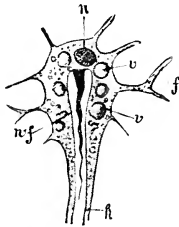

FIG. 217.—Flame-cell of a Turbellarian. *f.* processes; *k.* termination of capillary; *n.* nucleus; *v.* vacuoles; *wf.* ciliary flame. (After Lang.)

a contractile *excretory sac*. In *Temnocephala* each dorsally opening excretory sac has ramifying through its wall—which consists mainly of a single large cell—a system of capillary vessels containing ciliary flames.

In the Cestodes there are usually four longitudinal trunks, which open through a contractile excretory sac at the posterior end of the body. In many cases it has been shown that the main trunks communicate with the exterior at intervals by means of fine canals. The excretory sac is thrown off when the last proglottis becomes separated off and does not in most cases become renewed, though in at least one species of Tape-worm (*Tænia cucumerina*) a new vesicle is developed again and again at the end of the body as a fresh segment is thrown off. The main trunks are connected together by a *ring-vessel* in the head and in some cases by a *transverse branch* in each proglottis, and where the latter originate from the main trunks are valves formed by folds of the wall of the vessel. In the posterior region only two of the longitudinal trunks (one on each side) may be retained.

The sexes are united in all the Platyhelminthes with a few exceptions, and the **reproductive organs** are sometimes somewhat complicated—presenting a remarkable advance on those of the Cœlenterata. The male part of the apparatus consists of *testes*, with their ducts, the *vasa deferentia*, often with a contractile terminal enlargement or *vesicula seminalis*, a *cirrus*¹ or a *penis*, and often *prostate* or *granule glands*. The female part comprises *ovary* or *ovaries*, *receptaculum*, *oviduct*, *uterus*, an *ootype*,

¹ The term *cirrus* is here restricted to cases in which the terminal part of the male duct, often provided with spines and other chitinous structures, is involuted within a sheath when at rest.

often a *bursa copulatrix*, "shell-glands," vitelline or yolk-glands, and cement-glands. In most, though not in all, there is a single or paired *germarium* (ovary), in which the ova are formed, and a set of *vitellaria* or *vitelline glands*, producing material which surrounds each of the mature impregnated ova before it becomes enclosed in its shell. In some, on the other hand, ova and vitelline matter are formed in the same organ—the *germ-vitellarium*. The *shell-glands* were so named because they were usually supposed to secrete the chitinoid substance of the egg-shells; but the share which they take in this process, if they take any, is uncertain, and they are better called *accessory female glands*. The *cement-glands* secrete a viscid material for causing the eggs to adhere together, enclosing them in a cocoon or fastening them to some foreign body. The *oviduct* is the passage by which the ova reach the exterior from the ovary; but an enlarged part of this passage, into which ducts of the accessory glands open, is distinguishable as the *ootype*, while a terminal part, leading to the female aperture, may be modified as a *vagina*. In some cases (Heterocotylean Trematodes) there is a vagina or a pair of vaginæ in the shape of a passage, or a pair of passages, distinct from the oviduct and opening independently on the exterior. A *uterus* in the form of an enlarged part of the oviduct or of an outgrowth from the latter or from the atrium is very usually developed for the reception of the completed eggs. A special sac or *bursa copulatrix*, lined with spines, acts as the female copulatory organ. A sac, the *receptaculum*, opening into the oviduct or into the atrium (Figs. 204, 205, *r.v.*), may serve as a reservoir for the semen received in copulation or for the vitelline matter or yolk, or for surplus reproductive material. Male and female ducts sometimes have separate and independent openings; but very usually there is a common chamber or *genital atrium* into which both lead, opening on the exterior by a single aperture.

In the Polyclad Turbellaria (Fig. 215) the *testes* are numerous, and there are a corresponding number of fine tubes which combine to form the two *vasa deferentia*, leading to the male aperture with its penis. The latter is sometimes double or multiple. The *ovaries* consist of numerous small rounded masses of cells, and there are no separate yolk-glands. Numerous narrow oviducts lead from the ovaries, and unite to form larger ducts; these, in turn, open into two elongated *uteri*, in which numerous large eggs containing abundant yolk collect. The ducts of the uteri open into a median *egg-duct* or *vagina*, with which the ducts of the accessory glands communicate, and in which the eggs receive their chitinoid investment, derived in this case from the yolk-material of the substance of the ova. The vagina leads to the female aperture, a part of it being, in some cases, surrounded by a muscular sheath.

In many cases the egg-duct gives off posteriorly a narrow duct which usually terminates behind in a vesicle known as the *accessory sac* or *receptaculum*: this may be double. In a few Polyclads this duct opens on the exterior on the ventral surface some distance behind the main female aperture, in one instance on the dorsal surface. A *genito-intestinal canal* connecting this duct with one of the intestinal cæca has been found in one Polyclad. In most cases male and female apertures are distinct from one another, the former being situated in front of the latter. But sometimes, though rarely, both lead into a common chamber or *atrium* with a single opening on the exterior.

In the Tricladida (Fig. 216) there are also numerous testes, but the fine tubes connecting them with the two *vasa deferentia* are absent. There are two germaria, situated far forwards, and numerous yolk-glands. Two oviducts, into which the yolk is discharged from the yolk-glands by a series of lateral apertures, lead from the ovaries to unite in a median *ootype* or *vagina*, receiving the ducts of glands which may secrete the substance of the cocoon. The condition is thus intermediate between that observable in most of the Rhabdocœles and that which characterises the Polyclads. Though germaria and vitellaria are separate, they have a common duct, and might be regarded as distinct lobes of one germo-vitellarium. A uterus is present, formed as an outgrowth of the vagina or of the atrium, or as an independent sac or pair of sacs opening independently on the exterior. There may be a *receptaculum seminis*, and in some there is a duct of communication between this and the intestine (*genito-intestinal canal*). A common genital atrium with a single external aperture receives the ducts of both sexes.

In the Rhabdocœles (Figs. 214 and 218) there are usually only two compact testes and two *vasa deferentia* leading to the unpaired male aperture at the extremity of the cirrus. The *prostate* or *granule glands*—a set of unicellular glands, which secrete round, bright granules destined to mix with the sperms—are specially well developed in the Rhabdocœles, and are present in some other Turbellaria and in certain Trematodes. Ovaries (*germ-vitellaria*) alone occur in some, separate germaria and vitellaria in others; there are either two germaria or one only. A *receptaculum* may be present as a swelling or diverticulum of the main female duct, or of the atrium. The terminal part of this duct may form a muscular *vagina*, or there may be a muscular *bursa copulatrix* developed from the wall of the atrium. A *uterus* is present in most cases as an outgrowth from the wall of the atrium. Male and female ducts have a common chamber or *genital atrium* with a single external opening.

In the *Acala* there are in nearly all cases separate male and female apertures. The two testes are divided into numerous small

lobes. There are no vitellaria in most cases—the two ovaries producing large ova containing abundant food-yolk and the substance of the egg-shell being formed from droplets in the latter. Oviducts are absent in most cases. Into the main female genital passage or *antrum femininum* opens a peculiar single or double sac or *bursa*, usually provided with chitinous structures. In one case at least (*Heterochærus*) there is a passage leading from the antrum femininum to an aperture on the dorsal surface.

Most of the Trematodes have two testes (reduced to one in *Aspidocotylea* and *Heterocotylea*), usually compact, sometimes branched; in a few instances there are four. The vasa deferentia unite into a median duct, which is dilated at the base of the cirrus to form a vesicula seminalis. There is a single oval or branched *germarium*, and two sets of vitelline glands. A canal termed *Laurer's canal* in some Malacocotyleans, such as some species of *Distomum*, leads from the exterior to the oviduct or vitelline duct. This may be replaced by a receptaculum seminis, or both structures may co-exist. The distal part of the oviduct is enlarged to act as a uterus. In the *Heterocotylea* there is a vagina, which is sometimes paired, opening on the surface independently of the uterus: internally it communicates with the oviduct through the main vitelline duct. In some of the *Heterocotylea* there is a genito-intestinal canal occupying a corresponding position to Laurer's canal, but opening into the intestine. In the *Aspidocotylea* this is replaced by a stalked *yolk-receptacle*. There is nearly always a genital atrium common to the ducts of both sexes.

In the *Temnocephalea* (Figs. 204, 205) there are a genital atrium and a single genital aperture. There are two pairs of compact testes; the right and left vasa deferentia unite in a vesicula seminalis, and granule or prostate glands are well developed. The cirrus has a chitinous tube and a variety of eversible spines. There is a single compact germarium; the oviduct has connected with it a large receptaculum, and dilates posteriorly to form an ootype into

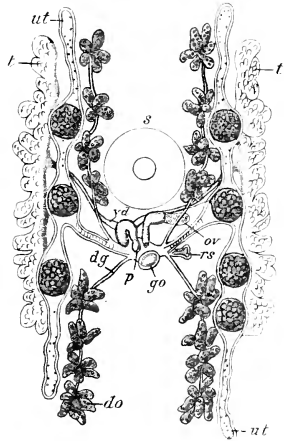

FIG. 218.—Reproductive organs of *Mesostomum ehrenbergii*. dg, duct of vitelline glands; do, vitelline glands; go, common reproductive aperture; or, ovary; p, cirrus; rs, receptaculum seminis; s, pharynx; t, testes; ut, uterus; rd, vas deferens. (From Claus, after von Graff and Schneider.)

which the "shell-glands" open. *Actinodactylella* alone has a *bursa copulatrix* (Fig. 205, b. c.).

In the ordinary Cestodes each segment or proglottis contains a set of reproductive organs similar to those of a Trematode. There may be a single genital aperture leading into a genital atrium, into which both male and female ducts open; or the male and female apertures may be distinct. The testis is divided into numerous minute lobes, from which proceed a number of fine canals joining together to form the vas deferens, at the extremity of which is the chitinous cirrus. There are two germaria, and either a single vitelline gland, or two. The oviduct has its origin in a sort of isthmus connecting the two germaria. It receives a narrow fertilising duct from the receptaculum seminis, and then the vitelline ducts, and becomes surrounded by a rounded mass of accessory glands to form the ootype, which is not definitely enlarged. Further forward it gives off the uterus. The latter is at first a simple cylindrical outgrowth from the oviduct, but it usually becomes large and may be extensively ramified. It has no external opening in most instances, so that the eggs only escape from it by the breaking down of the proglottis or by dehiscence. But in some (e.g., *Dibothriocephalus*) it has an independent external opening. The female aperture leads into a narrow canal—the vagina—which ends in a receptaculum seminis from which the narrow fertilising duct conveys the sperms to the oviduct. In a small number of Cestodes the sexes are distinct.

The **development** of some of the Platyhelminthes (Rhabdocœla, Monogenetic Trematodes) is direct—i.e., not complicated by the occurrence of a metamorphosis; in the Digenetic Trematodes, the Cestodes, and some of the Planarians a metamorphosis occurs.

The eggs of the Polyclads, each of which consists merely of the fertilised ovum (oosperm) usually enclosed in an egg-shell, are, in most instances, laid in large numbers embedded in a plate or capsule of slimy secretion. The ovum divides first into two parts, then into four. These are slightly unequal in size, one of them being somewhat larger than the others, and by the position of this and its relations to the other three the chief axes and planes of the embryo are already determinable at this early stage. In the notation adopted in following out the *cell-lineage* or order of development of cell from cell in the embryo, this largest cell is known as *D*: the other three are *A*, *B*, *C*—the lettering following the direction of movement of the hands of a clock when looked at from above. As shown by subsequent changes, *D* is posterior, *B* anterior, *A* and *C* are lateral. From these four cells (*megameres*) are given off above in succession four sets or quartettes, each composed of four cells. The members of the first quartette are designated *1a*, *1b*, *1c*, and *1d*, the small letter of each indicating derivation

from the megamere with the corresponding capital; those of the second quartette are *2a*, *2b*, *2c*, and *2d*; and so on with the others. From the way in which the cells of the quartettes are given off, the type of segmentation here exemplified, which prevails also in the Annulata (Section X) and most of the Mollusca (Section XII), is known as the *spiral* type. The cells of the first three quartettes are all composed of cells (*micromeres*) smaller than those from which they are derived. The formation of the third quartette results in a stage (Fig. 219) in which the embryo consists of thirty-two cells in all, since divisions take place in the cells of the first and second quartettes. In later stages the micromeres increase greatly by further division and extend as a cap, the ectoderm, composed of a single layer of small cells over all the upper part (animal) pole of the embryo; then spread further as a thin layer over the entire surface till only a slit-like blastopore is left on the ventral side: finally the blastopore closes and the ectoderm forms a complete investment.

Meanwhile the other embryonic layers have been established. It

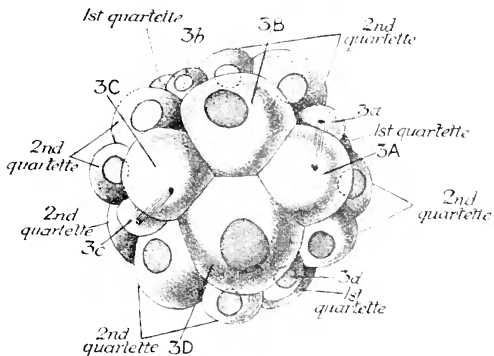

FIG. 219.—Developing egg of *Planocera*: thirty-two cell stage, seen from the lower (vegetative) pole. As the four original megameres, *A—D*, have now each given off three cells in succession, their designations are now *3A—3D*. (From MacBride, after Surface.)

is one of the cells of the fourth quartette that is alone or mainly responsible for the origin of the endoderm and a great part of the mesoderm. The four original megameres, *A*, *B*, *C*, and *D*, now reduced to quite small cells (Fig. 220, *mac*), after the separating off of the fourth quartette take no further part in development, and are ultimately absorbed. Of the four cells of the fourth quartette, which are comparatively large, three become broken up into masses of yolk material to be subsequently absorbed as food; but they may (*Discocaelis*) first give off cells which contribute to the formation of the endoderm. The fourth (designated *4d*) gives rise to the whole of the endoderm—or (in *Discocaelis*) the whole with the exception of the portion derived from the other three cells of the fourth quartette—and a considerable part of the mesoderm. *4d*

divides into two cells, an outer ($4d'$) and an inner ($4d_2$); the former divides to give rise to the greater part of the endoderm (*end*). The latter, dividing into two cells, each of which contributes a small cell (*end'*) to the pharyngeal part of the endoderm, gives rise to two strings of cells (*mes*) extending obliquely forwards and spreading out to form eventually a continuous layer constituting the greater part of the mesoderm. The mesoderm in the neighbourhood of the stomodæum is independently developed from descendants of the second quartette.

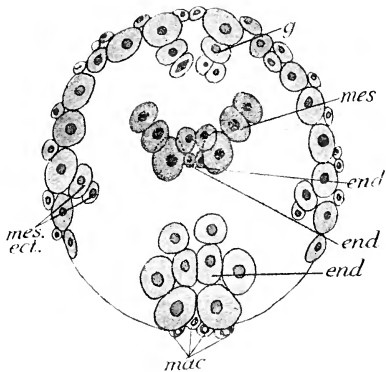

FIG. 220.—Embryo of *Planocera*. Diagrammatic frontal section, passing through animal (upper) and vegetative (lower) poles. *mes.*, mesodermal bands (products, with *end'*, of $4d_2$); *end*, endoderm (products of $4d_1$); *end'*, small endoderm cells formed from mesoderm rudiment; *mac*, vestigial megameres; *mes. ect.*, cells of ectodermal origin derived from the second quartette which migrate inwards to form muscles of the stomodæum; *g.*, cells forming rudiment of brain. (From MacBride, after Surface.)

The mesoderm in the neighbourhood of the stomodæum is independently developed from descendants of the second quartette.

The process by which the germinal layers have become formed is, as in the Ctenophora (p. 215), a process of *epibolic gastrulation*. The brain is developed from a pair of thickenings of the ectoderm (Fig. 220, *g*): these unite into a common mass from which the longitudinal nerves are formed as backward outgrowths. The mouth is developed as an ingrowth from the ectoderm in the position of the former blastopore, and, as the embryo

becomes flattened, passes from the posterior end to what is destined to be the ventral surface of the worm, while the muscular tissues of the wall of the pharynx are formed from surrounding mesodermal elements. The intestine is at first simple in form; the cæca are developed as a result of the formation of vertical mesodermal septa which, growing inwards, constrict the enteric wall and the enclosed mass of nutrient material. The embryo, which has assumed an ellipsoidal shape, becomes flattened in the dorso-ventral direction, and, having absorbed the greater part of the nutrient matter, escapes by rupture of the egg-shell.

In many cases the embryo develops into a characteristic larval form, such as that known as *Müller's larva* (Fig. 221). It assumes an oval shape, with a series of eight elongated processes, fringed with long cilia connected together into a continuous ciliated band. There are eye-spots at the anterior end and a mouth in the middle of the ventral surface. The form of the body alters after a time,

becoming gradually longer and flatter, and the arms are gradually reduced in length, till, eventually, they become completely absorbed.

The development of the Triclad is very different from that of the Polyclads. Each egg-capsule or cocoon encloses a number of oosperms and a quantity of yolk-cells. After segmentation a blastoderm is formed composed of a rounded mass of cells surrounded by the yolk-material, the cells of which become more or less fused. Around the periphery of the blastoderm a layer of cells forms a thin membrane—the ectoderm. About the middle appears a rounded group of cells which passes to the periphery and becomes connected with the ectoderm; a cavity is formed in its interior and it becomes converted into the embryonal pharynx. Meanwhile a group of four cells enclosing a cavity is modified to form the foundation of the endoderm, and increasing in number gives rise to the embryonal intestine, into which the embryonal pharynx soon opens, the latter opening on the exterior by a mouth aperture.

The embryonal pharynx (Fig. 222, *ph*₁) has the function of swallowing the yolk-matter with which the embryonal intestine becomes greatly distended. At a subsequent stage the embryonal pharynx and intestine are aborted, and the former comes to be represented merely by a mass of cells. In this a cavity arises—the cavity of the permanent pharynx. The permanent intestine becomes formed and the cavity of the pharynx opens into its lumen. Subsequently the permanent mouth makes its appearance. The brain is formed in the thickness of the blastoderm, and thus appears to be of mesodermal origin, not of ectodermal, as in the Polyclads.

In some Rhabdocoeles (certain species of *Mesostoma*) two distinct kinds of eggs are formed—summer and winter eggs. The oosperms are deposited singly, and each, together with a mass of yolk-cells, is enclosed in a chitinous, usually stalked, shell. Segmentation takes place very much as in the Polyclads. No embryonal pharynx is formed, the permanent pharynx performing the function of swallowing the yolk-material: it appears to be of endodermal derivation. The intestine arises from a group of cells—the primitive endoderm—among which a cavity appears. But in some Rhabdocoeles no definite intestinal epithelium is developed, and the syncytial mass which represents it is only to be dis-

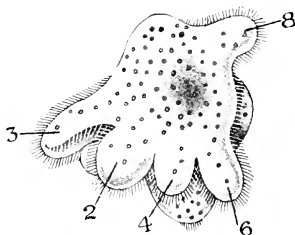

FIG. 221.—Müller's larva of *Yungia*. Lateral view. 2-6, ciliated processes. (From MacBride, after Lang.)

tinguished from the surrounding mesodermal syncytium by its enclosing the remains of the yolk. No metamorphosis is known to occur.

An account has already been given (p. 240, Fig. 193) of the development and metamorphosis of the Liver-Fluke (*Fasciola hepatica*) which may be looked upon as typical of the Digenetic Trematodes in general. There is thus to be recognised in the Digenetic Trematodes an *alternation of generations* comparable to that which has been described as so general in the Cœlenterata. In the Trematoda, however, it is to be observed, it is an alternation of a sexual, not with an asexual, but with a parthenogenetic generation (the sporocyst), the ova of which develop into a second

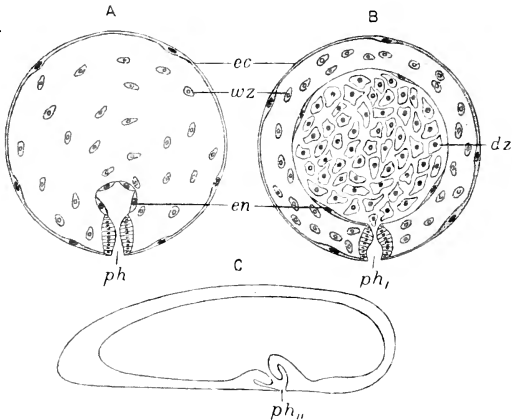

FIG. 222.—Sections through embryos of *Dendrocœlum lacteum* (somewhat diagrammatic). *dz*, yolk-cells; *cc*, ectoderm; *en*, endoderm; *ph*, embryonal pharynx; *ph₁*, permanent pharynx; *wz*, wandering cells. (From Korschelt and Heider, after Hallez.)

parthenogenetic generation (the rediæ); and these finally produce larvæ (the cercariæ) capable of developing into the sexually mature form. The term *heterogeny* is applied to a life-history of this kind, in which several distinct generations succeed one another in a regular series.

In some of the Distomidæ the eggs, instead of becoming free as in the case of the Liver-Fluke, are taken directly into the digestive canal of the intermediate host, and there hatched out. The sporocyst stage may take the form of a branching tube in the interior of which cercariæ are developed—the redia stage being omitted. Sometimes the sporocyst becomes directly developed into a redia instead of giving rise to a generation of the latter by

such a process of internal development as that described in the case of the Liver-Fluke. The cercariæ in most Digenetic Trematodes only develop further if they succeed in establishing themselves in a second intermediate host instead of merely becoming encysted on the surface of herbage, as in the case of the Liver-Fluke. The cercariæ of different Trematodes differ greatly, particularly with regard to the nature of the tail. In some forms the cercaria is tailless: such cercariæ do not become free, but are taken directly—with the intermediate host in which they have been developed—into the digestive canal of the final host.

Among the Heterocotylea, *Gyrodactylus* (Fig. 203, A) is viviparous, and the remarkable phenomenon is observed that the

embryo (h_1), while still within the body of the parent worm, develops another embryo (h_2) in its interior, and this again develops a third. The rest of the Heterocotylea deposit eggs each of which, within a chitinous shell, contains an oosperm and a number of yolk-cells. Usually there is a stalk, and often an operculum. In general the development appears to be direct; but *Polystomum* passes through a larval stage with

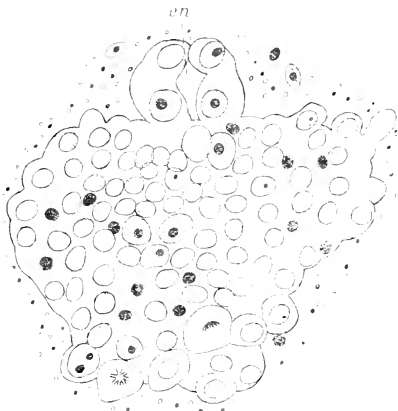

FIG. 223.—Section through the blastoderm of *Temnocephala*, showing early stage of endocole (*en*).

five rows of cilia, and in *Diplozoon paradoxum*, a parasite on the gills of certain fresh-water fishes, in which there is also a ciliated larval stage, the young animals do not become sexually mature until two of them have permanently united with one another.

Temnocephala produces relatively large eggs, stalked or sessile, with a thick chitinous shell, enclosing a single oosperm and a mass of yolk-cells, which later become fused into a continuous mass. Segmentation results in the formation of an irregular, massive blastoderm composed of cells of several sizes. In this collects a rounded group of larger cells, in the middle of which a space appears (Figs. 223, 224). The space (*endocole*) increases greatly in size, the boundary cells becoming spread out to form a thin layer, and approaches the periphery of the egg. A part of the

endocœle becomes subsequently rounded off to form the internal lining membrane of the pharynx, the cavity of which remains cut off from the exterior by a partition, which is the outer part of the wall of the endocœle, until the young worm is ready to leave the egg. A short prolongation backwards from this cavity ends blindly

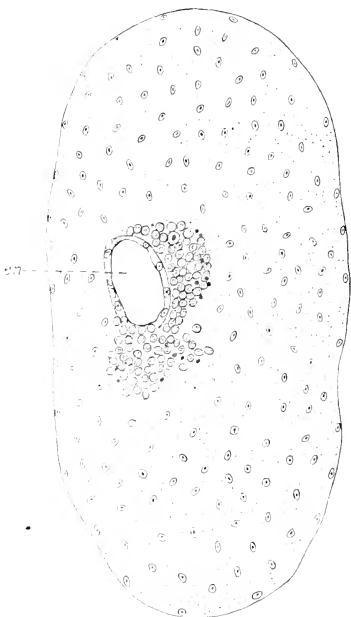

FIG. 224.—Longitudinal section through the entire egg of *Temnocephala* with the shell removed, showing blastoderm with developing endocœle (*en*).

in a mass composed mainly of yolk, still containing degenerate nuclei and cells which have wandered into it from the blastoderm. Only at a late stage, when the yolk has become taken up, is an arrangement of cells recognisable in the form of an intestinal epithelium (endoderm) enclosing a lumen (intestinal lumen). An ectoderm likewise does not appear as an embryonic layer, the epidermis only appearing late, and extending over the surface evidently by modification *in situ* of cells that have become separated from the main body of the blastoderm. The rudiments of the brain are formed in the blastoderm near the wall of the endocœle, and thus have no connection with an ectoderm. The excretory sacs and main vessels are formed from a small number of large cells connected with the wall of the endocœle: subsequently these rudiments shift their position to the dorsal surface on which the sacs form their permanent apertures piercing the epidermis. There is no metamorphosis of any kind—all the organs, including even the male part of the reproductive apparatus, being well advanced towards full development before the young animal leaves the egg.

The egg of a Cestode is similar in essential respects to that of a Trematode: there is a tough, chitinoid membrane or egg-shell, which encloses not only the ovum but a number of yolk-cells. The result of segmentation is the formation of a superficial layer of cells

in a mass composed mainly of yolk, still containing degenerate nuclei and cells which have wandered into it from the blastoderm. Only at a late stage, when the yolk has become taken up, is an arrangement of cells recognisable in the form of an intestinal epithelium (endoderm) enclosing a lumen (intestinal lumen). An ectoderm likewise does not appear as an embryonic layer, the epidermis only appearing late, and extending over the surface evidently by modification *in situ* of cells that have become separated from the main body of the blastoderm. The rudiments of the brain are formed in the blastoderm near the wall of the endocœle, and thus have no connection with an ectoderm. The excretory sacs and main vessels are formed from a small number of large

(ectoderm) and a central mass, all enclosed in a membrane composed of a single layer of cells thrown off when the embryo escapes from the egg. The ectodermal cells become ciliated, so far as is known, only in *Bothriocephalus*; in the others they are thrown off or ultimately absorbed without developing cilia. The central mass of cells alone forms the embryo. The embryo, while still consisting of a small number of cells, develops a series of six chitinous hooks. These early changes all take place in the majority of Cestodes while the egg is still in the uterus of one of the most posterior of the proglottides of the parent worm. When the proglottis in question becomes separated off, and has passed out from the body of the final host, the eggs are discharged.

In order that development may proceed further, the embryo must in most cases reach the interior of a second or *intermediate host*. This is a passive migration, since the embryo of the Cestode is still confined within the egg-shell, and the transference has to take place in the water or food. The digestive fluids of this intermediate host dissolve the egg-shell and set free the contained *six-hooked* or *hexacanth embryo*, which bores its way by means of its hooks to some part of the body in which it is destined to pass through the next phase in its life-history, and there becomes encysted.

The phase which follows presents two main varieties. In cases in which the intermediate host is an invertebrate animal the hooked embryo develops into a form to which the name of *cysticercoid* is given; when, on the other hand, the intermediate host is a vertebrate, the form assumed is nearly always that termed *cysticercus*, or bladder-worm. The cysticercoid form (Figs. 225 and 226) is to be regarded as the more primitive and less modified. Cysticercoids of various tape-worms occur in a great variety of different invertebrates—*e.g.*, Insects of all kinds, Water-fleas, Centipedes, Earthworms. The hooked embryo loses its hooks and develops into the cysticercoid in some part of the invertebrate intermediate host. The cysticercoid consists of three parts—a tape-worm *head* or *scolex* with the hooks and suckers of the mature worm, a so-called *body*, and a *caudal vesicle*. Sometimes there is a tail recalling to some extent the tail of a cercaria. Sometimes the caudal vesicle is absent: when present, either from the first, or as a result of later changes, it encloses the head as well as the body after the manner of a cyst. While undergoing these changes the cysticercoid is usually enclosed in an adventitious cyst formed for it by the tissues of its host, but it often lies free in the body-cavity. The transference to the final host is effected by the intermediate host, or the part of it containing the cysticercoid, being taken into the alimentary canal of the final host. Sometimes, if the intermediate host is a relatively small animal, such as a water-flea, this may take place “accidentally”; in other

cases the invertebrate intermediate host actually forms the food of the final host. Thus a cysticeroid having as an intermediate host an Earthworm is taken with the latter into the alimentary canal of a Sea-Gull—its final host. In this way the cysticeroid is set free in the alimentary canal of the final host, the head becomes pushed out from the enclosing caudal vesicle and body (probably owing to the stimulus of the higher temperature), so that the suckers and hooks come into play and attach the young tape-worm to the wall of the alimentary canal.

The *cysticercus* or bladder-worm differs from the cysticeroid mainly in its much greater size and in the development of a

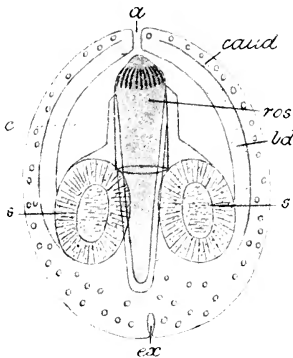

FIG. 225.—A **Cysticeroid** (*Polycercus*) with the head and rostellum enclosed by the caudal vesicle. *a*, aperture through which evagination takes place; *bd*, body; *c*, cavity of cyst; *caud*, caudal vesicle; *ex*, aperture of excretory system; *ros*, rostellum; *s*, sucker. (After Haswell and Hill.)

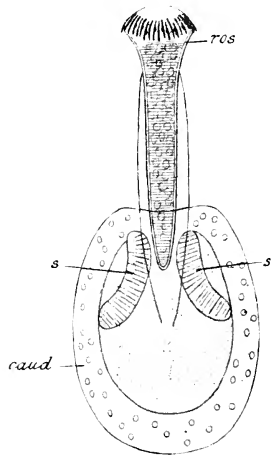

FIG. 226.—A **Cysticeroid** with the rostellum evaginated. *ros*, rostellum; *s*, *s*, suckers; *caud*, caudal vesicle. (After Haswell and Hill.)

relatively large caudal vesicle or caudal bladder. When the hooked embryo has reached that part of the vertebrate host in which it is destined to develop into the cysticercus it undergoes a remarkable change; it becomes greatly enlarged, and a cavity, filled with fluid or with a very loose form of connective-tissue, appears in its interior, so that it assumes the appearance of a relatively large bladder. On one side of this bladder appears a small invagination with a cavity opening freely on the exterior. On the bottom of this is formed an elevation projecting into its interior; this is the rudiment of the rostellum on which the hooks are borne; at its base, on the inner surface of the side walls of the

invagination, appear the suckers. When inverted this invagination corresponds closely with the head and body of the cysticercoid; the bladder corresponds to the caudal vesicle. Thus the chief difference between a cysticercus and a cysticercoid is that in the

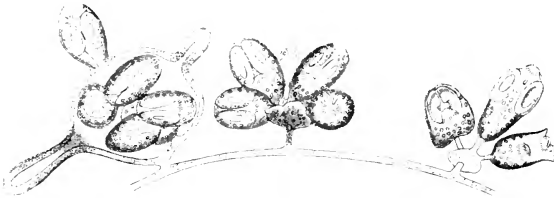

FIG. 227.—Cyst of *T. echinococcus* with the developing daughter-cysts and scolices. (After Leuckart.)

former the caudal vesicle is relatively very large and that the order of development of the parts is somewhat modified.

A very small number both of cysticercoids and cysticerci multiply by proliferation—by the formation of more than one tape-worm head from one embryo. In the few instances in which this occurs among the cysticercoids the hooked embryo gives rise, not directly to a cysticercoid, but to a

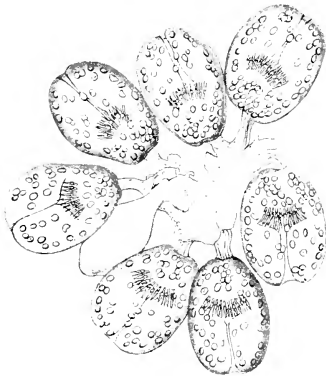

FIG. 228.—Scolices of *T. echinococcus*. (After Cobbold.)

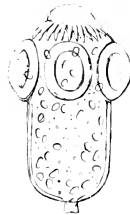

FIG. 229.—Separate scolice of *T. echinococcus*. (After Cobbold.)

mass of cells from which are given off a number of buds, each developing into a cysticercoid with the three parts already described. One such form occurs in certain Earthworms, another in a Myriapod (*Glomeris limbatus*).

T. caninus of the Dog has a bladder-worm stage in the Sheep and Rabbit which gives rise to several tape-worm heads, and the same holds good of *T. serialis* from the Fox. But

the best known instance of multiple production of scolices in a cysticercus is *Tania echinococcus*—well known as cause of the disease termed *hydatids*, common in Man and in various domestic animals. In this case the hooked embryo develops into a large *mother-cyst*, from the interior of which *daughter-cysts* are budded off (Fig. 227). Eventually from the walls of these daughter-cysts

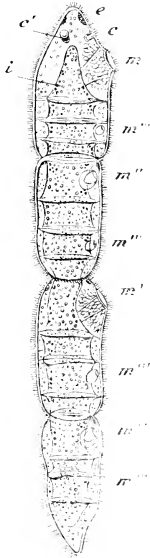

FIG. 230.—Process of budding in *Microstomum*. *e.*, *e.*, ciliated groove; *e.*, eye-spot; *i.*, intestine; *m.*, *m'*, *m''*, *m'''*, mouth. (After Von Graff.)

there are formed numerous tape-worm heads, or *scolices* (Figs. 228 and 229), which, when fully formed, assume the appearance of cysticercoids without the caudal vesicle. These are readily detached, and should the organ in which the cyst has been developed be devoured by a Dog—which is the final host of the parasite—some of these scolices become attached to the wall of the intestine and develop into the adult *Tania echinococcus*—which are very small as compared with the size of the cyst and as compared with other tape-worms. The eggs, passing out with the faeces of the Dog, may be taken into the digestive canal of Man or of one of the domestic animals, and the minute embryos escaping, reach some organ, such as the liver or lung, in which they are capable of developing into a comparatively enormous cyst.

Asexual reproduction also occurs in some Platyhelminthes. In some Rhabdocœle Turbellaria (*Microstomum*) a process of budding (Fig. 230) results in the formation of strings of sexual individuals which may eventually separate; the new bud is always formed from the posterior end of the last individual of the string.

The sporocyst stage in the Trematodes may, as already mentioned, multiply by budding or fission. The formation of new proglottides in the Tape-worm may be looked upon either simply as growth accompanied by segmentation, or as asexual multiplication, according as we regard the proglottides as *segments* of a simple animal or as *zooids* of a colony. There is this essential difference between the formation of proglottides and the asexual multiplication by budding in *Microstomum*, that in the former case the proglottides, when they have been formed by segmentation of the undivided part behind the head, do not in turn give rise by budding to new proglottides. Spontaneous transverse fission has been observed in certain Tricladida, and is often followed by the regeneration of the lost portion.

6. DISTRIBUTION, MODE OF OCCURRENCE, AND MUTUAL RELATIONSHIPS.

Of all the great groups of the animal kingdom above the Protozoa the Platyhelminthes are the widest in their *distribution*. Members of the phylum occur on land, in fresh water down to the bottom of some of the deepest lakes, on the sea-shore, in the deep sea, and on the surface of the ocean; and parasitic Flat-worms live, in one phase or another, in animals of nearly every class of the Metazoa.

As regards their *mode of life*, they present almost every possible gradation between free-living forms which procure their food—consisting of minute animals and plants—by their own exertions, and forms that are only capable of living in a special part of the interior of a certain other animal, and are quite incapable of procuring food for themselves, living by the passive absorption of the juices of their host or of its digested food. The Turbellaria are for the most part free-living, and their food consists of small Crustacea or the larvæ of larger forms, Insect larvæ, Water-mites, Rotifers, small Worms, and the like; or sometimes of Diatoms and minute Algæ of various kinds. Some, however, live a life of true parasitism. Such are certain Rhabdocœles which are parasitic in the alimentary canal of various Holothurians and Gephyreans (*vide* Sections IX and X). In these there is correlated with the inactive mode of life a tendency to degradation of structure, a degradation which is characteristic of parasites in general: the pharynx is reduced in size as compared with that of non-parasitic allied forms, not being required for the capture and swallowing of living prey; and the eyes, useless to an animal living in complete darkness, are absent. Some of the Turbellaria, though not parasitic in the strict sense, live in a state of *commensalism* with another, larger, animal: that is to say, are more or less constantly associated with it, living on its surface or in one of its cavities that open freely on the exterior, and often sharing its food. An example of this mode of life is the Triclad *Bdelloura*, which lives on the surface of the King-Crab (*Limulus*).

While a free existence is the rule in the Turbellaria, true parasitism is the rule in the Trematodes, and is universal in the Cestodes. The majority of the Monogenetic Trematodes are external parasites, living on a part of the outer surface of a larger animal, and feeding on mucus and other secretions of the integument. Many are parasites on the gills of Fishes. A few, however, inhabit the interior of various organs, and are true internal parasites: one, for example (*Polystomum*), lives in the urinary bladder of the Frog; another (*Aspidogaster*) lives in the pericardial cavity of a Fresh-water Mussel. At least one family of Trematodes (the *Temnocephalea*) are not parasites at all in the

strict sense of the term, living on the surface of the "host" animal, depositing their eggs there, and being carried about by it, but subsisting on minute living animals captured in the water.

The Digenetic Trematodes are all internal parasites, and in the adult condition inhabit, in nearly all cases, the alimentary canal, liver, or lungs of some vertebrate animal, swallowing the digested food or various secretions of their host. But, as mentioned before in the account given of their development, they are internal parasites, not only in the adult condition, but throughout the greater part of their life. After a short period of freedom as ciliated larvæ, they again enter into a state of parasitism as sporocysts or rediæ in a second host; and, after a second free interval as cercariæ, may enter the body of a third host to become encysted. The second host is, very generally, a Mollusc, and the cercaria may become encysted in the same animal.

The Cestodes are, of all the Platyhelminthes, those that are most modified in accordance with the condition of internal parasitism in which they remain throughout life. The adult Cestode is almost always an inhabitant of the alimentary canal of a vertebrate. The intermediate host is frequently also a vertebrate—commonly of a kind which is liable to become the prey of the final host. In the case of *Tænia crassicollis* of the intestine of the domestic Cat, for example, the cysticercus stage occurs in the livers of Rats and Mice; the cysticercus of *Tænia serrata* of the Dog is found in Hares and Rabbits. But in many cases the intermediate host is an invertebrate. In either case the passage from one host to another is a passive *translation*, not an active *migration* as in the Trematodes.

A few human parasites belong to the Trematoda, but none that are of very common occurrence among Europeans. *Fasciola hepatica* has occasionally been found in the human liver; *Distomum rathousii* is a common intestinal parasite in China; *Opisthorchis sinensis* occurs in the liver of Man in China and Japan; *Dicrocælium lanceatum* and various other species of the genus occasionally occur in the human subject. *Schistosomum hæmatobium* and *S. japonicum* (Fig. 231), otherwise known as *Bilharzia hæmatobia*, and *B. japonica*, which differ from most other Trematodes in being unisexual, are found in pairs in the sub-mucous tissue of the human urinary bladder or rectum in various parts of Africa and South America, in Arabia, the Philippines, and Japan. Eggs with contained larvæ are voided with the urine, and if they reach water, the ciliated larvæ or miracidia penetrate into the interior of a fresh-water snail and give rise to sporocysts from which cercariæ are developed. The latter become free, and, if the opportunity presents itself, may enter the human body through the skin or the mucous membrane of the mouth, and, entering the venous system,

find their way usually to the veins of the bladder or the large intestine and thence to the sub-mucous tissue, where they become sexually mature.

The commonest human Cestode parasites among Europeans are *Tænia solium* and *T. saginata* (otherwise called *T. mediocanellata*). The cysticercus stage of *T. solium* (*Cysticercus cellulosæ*) occurs, as already stated, chiefly in the muscles of the Pig, that of *T. saginata* in the muscles of the Ox; and the relative prevalence in different countries of these two Tape-Worms varies with the habits of the people with regard to flesh-eating: where more swine's flesh is eaten in an imperfectly cooked state *Tænia solium* is the more prevalent; where more beef, *T. saginata*. *Bothriocephalus latus*, a very large tape-worm without hooks, and with a pair of longitudinal sucking-grooves on the head instead of ordinary suckers, is a common human parasite in Eastern countries. Its cysticercus, which is elongated and solid, occurs in the Pike and certain other fresh-water Fishes.

Of all the Cestode parasites of man, however, the most formidable is one which occurs in the human body, not in the sexually mature or strobila condition, but in that of the cysticercus. This is *Tænia echinococcus*, the presence of which produces what is termed hydatid disease (p. 278). The adult *Tænia echinococcus* is a very small tape-worm with only three or four proglottides, occurring in the intestine of the domestic Dog. The eggs passing out with a liberated proglottis in the fæces may reach the alimentary canal of Man uninjured in drinking water, on the surface of salad vegetables, and the like; and, the egg-shells becoming dissolved, the contained hooked embryos bore their way to the liver or the lungs or some other organ. Arrived at its final destination, the embryo develops into a cyst, which may become of enormous size. In the interior of the *primary* or *mother-cyst* are developed a number of *secondary* or *daughter-cysts*, and from the walls of these, both internally and externally, are formed very numerous scolices in the way already described (p. 278). Hydatid cysts are very common in some domestic animals (Oxen, Sheep), as well as in Man. Various other Cestodes occur in the bladder-worm stage occasionally in Man—e.g., the *Cysticercus cellulosæ* of *Tænia solium*.

The most primitive of the Platyhelminthes are, without doubt,

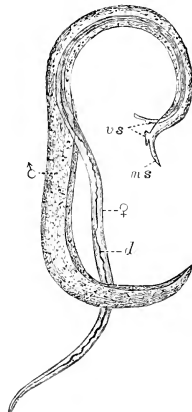

Fig. 231.—*Bilharzia hæmatobia*. The female (♀) lying in a ventral groove of the male (♂). *d.* alimentary canal; *ms.* oral sucker of male; *v.s.* ventral suckers. (After Leuckart.)

some of the simplest Turbellaria, and it is among these that we must look for the nearest existing relatives to the Cœlenterata. In none, however, is the relationship very close. *Cæloplana* and *Ctenoplana* (p. 221) are probably rather to be looked upon as Ctenophores specially modified in accordance with a creeping mode of progression than as intermediate forms between Ctenophores and Turbellaria. The relationship with the Cœlenterata is shown, perhaps, most strikingly when we take into account the development of the Turbellaria, in the earlier stages of which there is to be recognised a marked tendency towards a radial symmetry. In their development the Turbellaria, that is to say the Polyclads, show some special points of resemblance to the Ctenophora; the ectoderm cells are formed and spread over the rest in a similar way, and the bands of cilia have a disposition and mode of movement that strongly bring to mind the ciliary swimming plates of the Ctenophora. But though there is much to be said in favour of the view that the Turbellaria and the Ctenophora were derived from a common, not very distant, stock, the latter are too specially modified to be looked upon as the direct ancestors of the former.

The connection between the Turbellaria and the Monogenetic Trematodes is very close—so much so that it is difficult to give any characters of universal occurrence distinguishing all the members of the two classes. The Trematodes are, in fact, to be looked upon as Turbellaria some of whose external characteristics—and, in the case of the Digenetica, whose life-history—have been specially modified in accordance with a parasitic mode of life. It is not unlikely that the Trematodes may be a *polyphyletic* group—*i.e.*, that different families may have become developed from different families of Turbellaria altogether independently, some of them appearing to be nearer the Rhabdocœles, others nearer the Polyclads, and others, again, nearer the Triclad, in the majority of their characters.

The remarkable life-history of the Digenetic Trematodes may, as already pointed out, be looked upon as a special form of alternation of generations—the alternation of a *sexual* with a *pædogenic* and *parthenogenetic* generation (heterogeny). The sporocyst and redia are to be regarded as intercalated stages—as cercariæ which exhibit pædogensis. The cercaria is the characteristic larval stage of the Trematodes, and corresponds to the cysticercus or cysticercoid of the Cestode. The most important difference between these is in the presence in the former of an enteric cavity, and its absence in the latter. There seems to be something to be said in favour of the view that the enteric cavity of the cercaria is represented by the frontal sucker of some scolices, and by the rostellum of the majority.

Between the adult Cestodes and the Trematodes an intimate

relationship is traceable. *Caryophyllæus* (Fig. 209) is a Cestode which, but for the absence of an enteric cavity and the want of organs of adhesion at the posterior end, is not far distant from the Trematodes; and the same might be said of *Gyrocotyle* (Fig. 210), *Amphilina*, and *Archigetes* (Fig. 211).¹ The most important difference between a Cestode and a Trematode, in addition to the absence of an enteric cavity in the former and its presence in the latter, is the occurrence in the Cestodes of strobilation. *Ligula* in a certain sense forms a connecting link in this respect between the Trematode and the ordinary Cestode, the body being elongated and the reproductive organs repeated as in

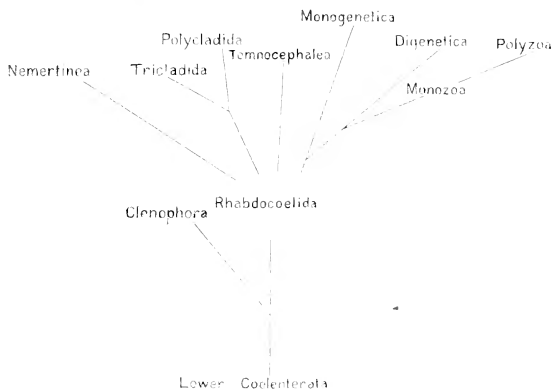

FIG. 232.—Diagram of the relationships of the Platyhelminthes (together with the Nemertinea).

the normal Tape-Worm, but there being no corresponding division of the body into a string of definitely separated proglottides.

Of importance in connection with the subject of the relationship of Trematodes and Cestodes is the question whether the scolex of the latter is at the end corresponding to the anterior end of the former, or whether it is the free end of the strobilia that is in reality anterior. In favour of the latter conclusion is the fact that the hooks of the hexacanth larva, developed at its anterior end, are found in the cysticeroid to lie in the tail region, *i.e.*, the region most remote from that which develops the scolex, and thus at the end which should represent the free extremity of the strobila. On the other hand, the specialisation of the nervous system to form quite definite and comparatively elaborate nerve-

¹ It is possible, however, that in the last two forms we have to do with larval Cestodes which have failed to reach the mature stage, and have undergone a precocious development of the sexual apparatus.

centres (brain) in the scolex of some Cestodes (e.g., *Moniezia*) tells in favour of the view that the scolex is anterior and corresponds to a head.

APPENDIX TO PLATYHELMINTHES.

CLASS NEMERTINEA.

General Features.—The Nemertean worms are non-parasitic, unsegmented worms, most of which are marine, only a few forms living on land or in fresh water. They are commonly looked upon as nearly related to the Turbellaria and were formerly included in that class; but in some respects they are higher in organisation than the Turbellaria, and they exhibit certain special features distinguishing them from the rest of the lower Worms.

The body (Fig. 233) is nearly always narrow and elongated, cylindrical or depressed, unsegmented and devoid of appendages. In length it varies from a few millimetres to as much as twenty-seven metres. In some cases there is a short narrower posterior region or "tail"; a head is rarely marked off from the body proper. The entire surface is covered with vibratile cilia, and frequently the integument is vividly coloured. Gland-cells of the epidermis secrete a mucous matter, which may serve as a sheath or tube for the animal. The *mouth* (*m.*) is at or near the anterior extremity on the ventral aspect. Near it in front (rarely united with it) there is an opening through which can be protruded a very long muscular organ, the *proboscis* (*pr.*), the possession of

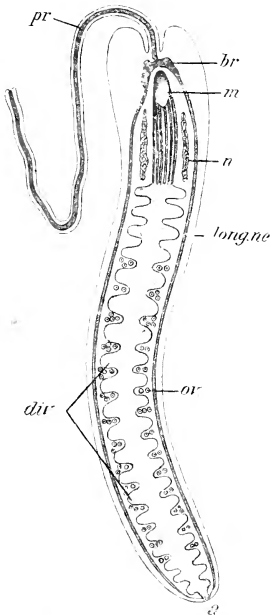

FIG. 233.—Diagram of the organs of a Nemertine, from below. *a.* anus; *br.* brain; *dir.* caeca; *long. ne.* longitudinal nerve-cords; *m.* mouth; *n.* nephridia; *ov.* ovaries; *pr.* proboscis. (After Hübner.)

which is one of the most characteristic features of this class of Worms. The proboscis is hollow; when extended to its utmost, a part still remains which is not capable of being everted. This hollow tube (Fig. 234) is open in front, where its edges are continuous

with the body-wall, and closed behind. Its wall in the eversible part consists of an epithelium (internal when at rest) continuous with the epidermis and similar to the latter, a basement membrane, and either two or three layers of muscle, circular and longitudinal, with an external thin epithelium of flat cells. The circular muscular fibres are not continued back on the non-eversible part, but the longitudinal fibres pass backwards to form the *retractor muscle*, by means of which the proboscis is attached to the sheath in which it is enclosed, and by means of which also it is retracted. The internal epithelium of the proboscis develops variously formed and arranged papillæ, and in most cases its cells form rods of a similar character to that of the rods or rhabdites of Turbellaria. In the part between the eversible and non-eversible regions—a part

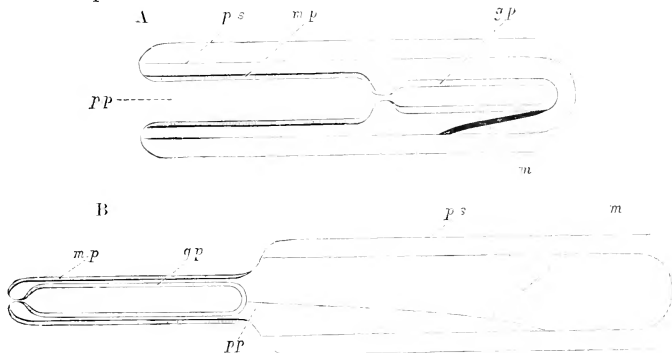

FIG. 234.—Diagrammatic representation of proboscis: (A) in the retracted condition, (B) in the everted condition. *g. p.* glandular portion of the proboscis; *m.* muscle attaching the proboscis to its sheath; *m. p.* muscular portion of the proboscis; *p. p.* in A, proboscis pore; *p. p.* in B represents the position of the proboscis pore in the retracted condition of the proboscis; *p. s.* proboscis sheath. (After Sheldon.)

which may itself become elongated and complicated in structure—is developed in many Nemerteans (*Metanemertini*) a median calcareous stylet (Figs. 237, 238) with groups of smaller accessory stylets at the sides. In the everted proboscis these are borne at the free anterior extremity, and are thus capable of being used as weapons. In *Drepanophorus* there are a number of small stylets supported on a narrow curved plate, together with accessory stylets. In the rest of the Nemerteans stylets are not developed. It is by contraction of the muscular walls of the sheath, the cavity of which (*rhynchocæle*) contains a corpusculated fluid, that the proboscis becomes everted. The abundant nerve-supply of the proboscis points to its being used partly as a tactile organ.

The outermost layer of the **body-wall** is an epidermis of columnar cells, many of which are ciliated, while others are

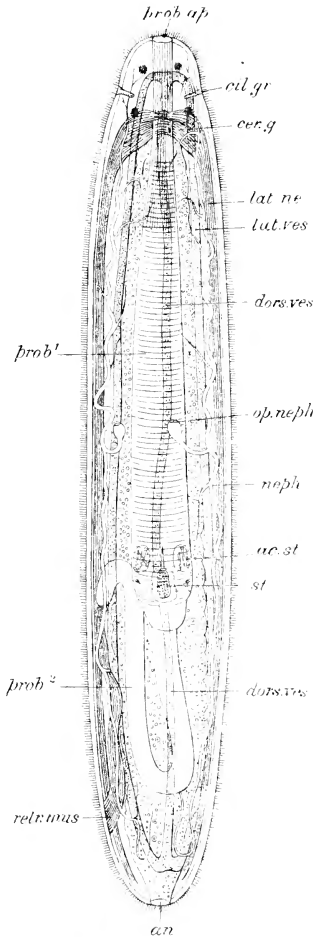

FIG. 235.—**Tetrastemma.** General view of the internal organs. *an.* anus; *ac. st.* accessory stylet; *cer. g.* brain; *cil. gr.* ciliated groove of cerebral organ; *dors. ves.* dorsal vessel; *lat. ne.* lateral nerve; *lat. ves.* lateral vessel; *neph.* nephridium; *op. neph.* nephridial aperture; *prob. 1.* eversible part of proboscis; *prob. 2.* non-eversible part of proboscis; *prob. ap.* aperture for the protrusion of the proboscis; *retr. mus.* retractor muscle of the proboscis; *st.* stylet. (From Hatschek's *Lehrbuch.*)

unicellular glands, some of which are arranged in groups; these secrete the mucus with which the surface is usually covered, and which may form a gelatinous tube. Beneath the epidermis is a basement membrane, very thin in most cases, followed by the muscular layers. In some Nemertean (whence called *Dimyaria*) there are only two layers of muscular fibres, an outer circular and an inner longitudinal; in the rest (*Trimyaria*) a third (longitudinal) layer is superadded. Another circular layer of muscular fibres closely encompasses the digestive canal. The interspace enclosed by the outer muscular layers does not comprise any cavity corresponding to a true cœlome or body-cavity, except, perhaps, the cavities of the gonads, the interspaces between the organs being filled with parenchyma (Fig. 239).

The digestive canal consists of a tube which extends throughout the length of the body from the mouth—situated near the anterior extremity on the ventral side—to the anus at the posterior extremity.¹ The mouth is usually placed some distance behind the proboscis pore, but may be shifted forwards so as to lie close to the latter, or to be incorporated with it. The first part of the digestive canal is usually a simple tube—*œsophagus* (*stomodæum*)—but may be more complicated, and divided into

¹ When a tail is present the intestine may, or may not, be continued through it.

various regions, sometimes with paired diverticula. Posteriorly it opens into the intestine. The *intestine*, constituting by far the greater part of the length of the canal, may be a simple uncontracted tube, or may be only slightly constricted at intervals by the paired gonads. In most cases the constrictions corresponding to the gonads are very deep, so that the intestine comes to be provided with two rows of lateral diverticula or cæca, which may be branched. The cæca are separated from one another by incomplete transverse septa of dorso-ventral muscular fibres—the arrangement of the cæca and septa with the alternately arranged gonads bringing about an appearance of imperfect metamerism such as is observable in some of the Platyhelminthes (*Gunda*, species of *Temnocephala*).

The Nemerteans possess a system of vessels usually regarded as representing a blood-vascular system (Figs. 235 and 240), with well-defined walls consisting of a layer of epithelium surrounded by a thin layer of muscular fibres arranged circularly.

There are three principal longitudinal trunks—a *median dorsal* (*dors. ves. d.b., d.v.*) and two *lateral* (*lat. ves. l.v., l.b.*). The blood is, in most cases, colourless, and contains rounded or elliptical, usually colourless, corpuscles.

The excretory system has a considerable resemblance to that of the Platyhelminthes. It consists of a pair of longitudinal vessels (Fig. 235, *neph.*) which give off branches, by one or several of which each communicates with the exterior. In one species of *Eupolia* there are also ducts opening into the alimentary canal. The fine terminal branches of the system are provided with *ciliary flames*, each situated in the midst of a group of cells, not in the interior of a single flame-cell as in most cases in the Flat-worms.

There are no special organs of respiration in any of the group. But there is evidence that this function is carried out, in part at

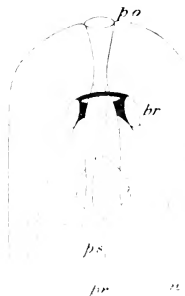
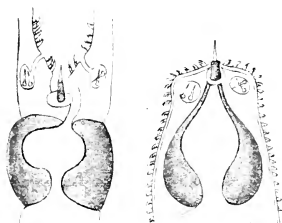

FIG. 236.—Anterior portion of the body of a Nemertine. *br.* brain-lobes; *n.* lateral nerves; *p. o.* external opening through which the proboscis is everted; *p. s.* proboscis-sheath; *pr.* proboscis. (Esophagus and mouth shown by dotted lines. (After Hubrecht.)



FIGS. 237 and 238.—Proboscis of a *Meta-nemertean*, with stylet reserve-sacs and muscular bulb. Fig. 237 retracted, Fig. 238 everted. (After Hubrecht.)

least, by the taking in and giving out of water through the mouth by the œsophagus.

The **nervous system** is in some respects more highly developed than in the *Turbellaria*. The **brain** (Figs. 233 and 236 *br.*, and Figs. 235, *cer. g.*, and 240, *n.g.d.*, *n.g.v.*) is composed of two pairs of ganglia, dorsal and ventral, the ganglia of each pair being connected together by commissures, the dorsal situated above, the ventral below, the anterior part of the proboscis and proboscis sheath, and both being above the mouth and œsophagus. From the brain pass backwards a pair of thick longitudinal nerve-cords which run throughout the length of the body. Usually these are

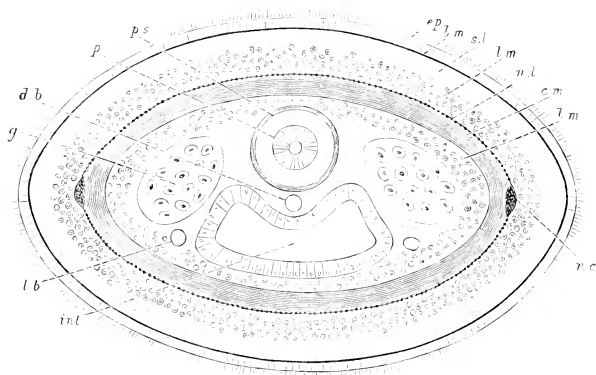

FIG. 239. —Diagrammatic transverse section of a **Nemertean** (*Heteronemertini*) through the middle region of the body. *b.m.* basement membrane; *c.m.* circular muscle layer; *d.b.* dorsal blood-vessel; *ep.* epidermis; *g.* gonads; *int.* intestine; *l.b.* lateral blood vessel; *l.m.* longitudinal muscle layer; *n.c.* lateral nerve cord; *n.p.* nerve plexus; *p.* proboscis; *p. s.* proboscis sheath; *s.t.* subcutaneous layer. (After Sheldon.)

lateral in position, sometimes approximated dorsally, sometimes ventrally. The lateral nerve-cords generally meet posteriorly in a commissure usually situated above, but in one genus below, the anus. A third median dorsal nerve of smaller size than the lateral cords extends backwards from the dorsal commissure of the brain. Associated with the nerve-cords in the *Protonemertini* and the *Heteronemertini* is a nerve-plexus (Fig. 239, *n.p.*) extending all over the body. In the *Metanemertini*, instead of a nerve-plexus, there is a series of slender transverse connectives running across at short intervals between the lateral nerve-cords, and from each cord are given off numerous branches arranged with some regularity.

The position of the brain and lateral nerve-cords and the nerve-plexus, or the system of commissures and nerve-branches, varies in the different groups. In the *Protonemertini* they occupy the most primitive position, being quite superficially

situated at the bases of the epidermal cells. In the rest they are deeper: in the Metanemertini they lie in the parenchyma within the muscular layers. The median cord is always, except in the Heteronemertines, superficially placed.

A remarkable apparatus connected with the nervous system is that composed of a pair of peculiar structures known as the **cerebral organs**. When most highly developed these consist of a pair of ciliated tubes, opening externally in the region of the brain and terminating internally in close relation to the dorsal ganglion of the brain or a special ganglion distinct from the latter. The external aperture may be situated in a groove or furrow (Fig. 235, *cil. gr.*), vertical or horizontal, of varying extent. This apparatus may have a respiratory function, more especially for the oxygenation of the substance of the brain, but perhaps it has also a sensory function. It has some resemblance to the ciliated pits developed in certain *Turbellaria*.

Eyes are present in the majority of Nemerteans, and in the more highly organised species occur in considerable numbers. Sometimes they are of extremely simple structure; in other cases they are more highly developed, having a spherical refractive body with a cellular "vitreous body," and a "retina" consisting of a layer of rods enclosed in a sheath of dark pigment, each rod having a separate nerve-branch connected with it. **Statocysts** containing statoliths have been found in only a few of the Nemerteans.

Reproductive System.—Most species are *diœcious*. The *ovaries* (Fig. 233, *ov.*) and *testes* are situated in the intervals between the intestinal cœca. The ovary or testis is a sac the cells lining which give rise to ova or spermatozoa; when these are mature each sac opens by means of a narrow duct leading to the dorsal, rarely to the ventral, surface, on which it opens by a pore. In all probability the cavities of these hollow gonads are all that represent the cœlome of higher forms.

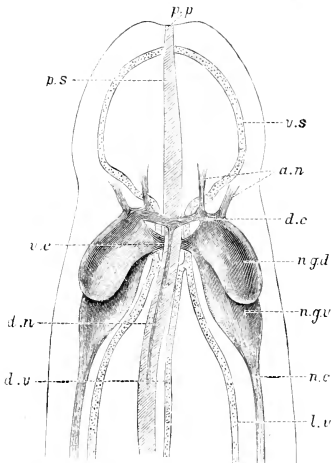

FIG. 240.—Diagram of anterior end of a **Nemertean** (*Metanemertini*). *a. n.* anterior nerves; *d. c.* dorsal commissure; *d. n.* dorsal median nerve; *d. v.* dorsal vessel; *l. v.* lateral vessel; *n. c.* lateral nerve-cord; *n. d. g.* dorsal ganglion; *n. g. v.* ventral ganglion; *p. p.* proboscis pore; *p. s.* proboscis sheath; *v. c.* ventral commissure; *v. s.* vascular ring or collar. (From Sheldon, modified from McIntosh.)

Development.—Some of the Nemerteans go through a metamorphosis; in the others the development is direct. The

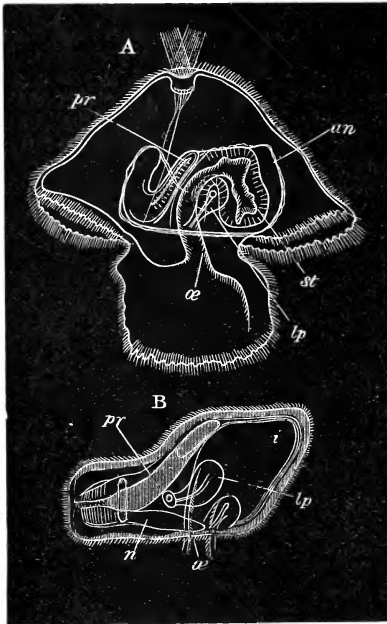

FIG. 241.—A, Pilidium with advanced Nemertine worm; B, ripe embryo of Nemertes from interior of pilidium. *an.* amnion, or investment of the embryo; *i.* intestine; *lp.* lateral pit; *n.* nervous system; *æ.* gullet; *pr.* proboscis; *st.* stomach. (From Baltour, after Bütschli.)

characteristic larval form is the *pilidium* (Fig. 241). This is a helmet-shaped body with side lobes like ear-lappets, and a bunch of cilia representing a spike. In the metamorphosis two pairs of ectodermal invaginations, growing inwards around the intestine, fuse together and form the integument and body-wall of the future worm, which subsequently frees itself from its investment and develops into the adult form. In others there is a ciliated creeping larva called the "*larva of Desor*," in the interior of which the larval worm is developed much as in the case of the pilidium.

DISTINCTIVE CHARACTERS AND CLASSIFICATION.

The Nemertinea are ciliated, unsegmented worms with elongated body, without distinct coelome. There is an eversible proboscis enclosed in a sheath and capable of being protruded to a great length through an aperture situated usually in front of and above the mouth. The intestine usually has distinct lateral diverticula, and there is a posteriorly situated anus. There is a blood-vascular system, and also a system of excretory vessels with ciliary flames.

ORDER 1. PROTONEMERTINI.

Dimyarian Nemertines with the lateral nerve-cords situated outside the muscular layers. The mouth is situated behind the brain. The proboscis is devoid of stylet.

ORDER 2. MESONEMERTINI.

Dimyarian Nemertines having the lateral nerve-cords withdrawn within the musculature of the body-wall. The mouth is situated behind the brain. There are no stylets.

ORDER 3. METANEMERTINI.

Dimyarian Nemertines, in which the lateral nerve-cords lie inside the muscular layers in the parenchyma. The mouth is situated in front of the brain. The proboscis is provided with stylets. A ventral (stomodæal) cæcum is present.

ORDER 4. HETERONEMERTINI.

Trimyarian Nemertines, in which the lateral nerve-cords are in the muscle-layers, between the outer longitudinal and the circular layers. The mouth is situated behind the brain. The proboscis has no stylet.

The Nemerteans are almost exclusively marine; and the greater number live between tide-marks or at moderate depths; a few have been obtained from considerable depths. The comparatively small number of terrestrial and fresh-water forms are all *Metanemertini*. The Nemerteans progress for the most part by slow crawling movements, leaving a track of slime behind them. Some burrow freely in mud or sand, the proboscis being made use of to help in the process. Some are able to swim by means of undulating movements of the body. Nearly all are carnivorous, and either capture living prey in the shape of small invertebrates of various kinds, or feed on dead fragments. The chief function of the proboscis is the capture of living prey, around which it becomes coiled and then draws the prey towards the mouth. One Nemertean lives in the interior of a Crustacean, and is probably a true parasite. Others live, apparently as commensals or mess-mates, in the pharynx or atrial cavity of Ascidians, or within the mantle cavity of bivalve Mollusca.

A striking feature of the Nemerteans is the readiness with which, on being irritated by handling or by the action of some chemical agent, they break up transversely into fragments. This takes place most freely when the body is highly charged with sexual products, but is by no means confined to that condition. The process probably takes place spontaneously under certain circumstances. The broken-off fragments may remain alive for a considerable time, and under suitable conditions regeneration of the lost parts is readily effected, so that it is possible to look upon the entire process as a form of asexual reproduction.

SECTION VI.

PHYLUM NEMATHELMINTHES.

THE members of the preceding phylum are characterised, as a whole, by a marked dorso-ventral flattening. In the Worms included in the present group the body is elongated and cylindrical, whence their general name of Round- or Thread-worms. The phylum includes the following classes :—

Class 1. NEMATODA.—The Round-worms in the strict sense of the term. The best known forms are internal parasites, but many genera and species are extremely abundant in fresh- and salt-water as well as in the soil.

Class 2. ACANTHOCEPHALA.—The “Hook-headed Worms,” a group of formidable internal parasites.

Class 3. CHÆTOGNATHA.—The “Arrow-worms,” a small group of pelagic organisms.

The affinities of the Acanthocephala and Chætognatha with the Nematoda are somewhat doubtful, and the association of the three classes is largely a matter of convenience.

CLASS I.—NEMATODA.

1. EXAMPLE OF THE CLASS—THE COMMON ROUND-WORM OF MAN. (*Ascaris lumbricoides*.)

Ascaris lumbricoides is a common parasite in the human intestine: a closely allied if not identical form (*A. suilla*) occurs in the Pig, and another (*A. megalcephala*) in the Horse. The following description will apply to any of these. The female *A. lumbricoides* is about 20-40 cm. (8-16 inches) long, and about 6-8 mm. ($\frac{1}{4}$ inch) in diameter; the male is considerably smaller.

External Characters.—When fresh the animal is of a light yellowish-brown colour: it is marked with four longitudinal streaks, two of which, very narrow and pure white in the living Worm, are respectively dorsal and ventral in position, and

are called the *dorsal* and *ventral lines* (Fig. 242, *d.l.*, *v.l.*): the other two are lateral in position, thicker than the former, and brown in colour, and are distinguished as the *lateral lines*. The *mouth* is anterior and terminal in position, and is bounded by three lobes, or *lips*, one median and dorsal (*d. lp.*), the other two ventro-lateral (*v. lp.*). A very minute aperture on the ventral side, and about 2 mm. from the anterior end, is the *excretory pore* (*ex. p.*). At about the same distance from the pointed and down-turned posterior end is a transverse aperture with thickened lips, the *anus* (*an.*), which in the male serves also as a reproductive aperture and gives exit to a pair of needle-like chitinoid bodies, the *penial setæ* (*pn. s.*). In the female the reproductive aperture or *gonopore* is separate from the anus, and is situated on the ventral surface about one-third of the length of the body from the anterior end (Fig. 245, *gnp.*). The sexes are also distinguished externally by the form of the short *tail*, or post-anal portion of the body, which in the male

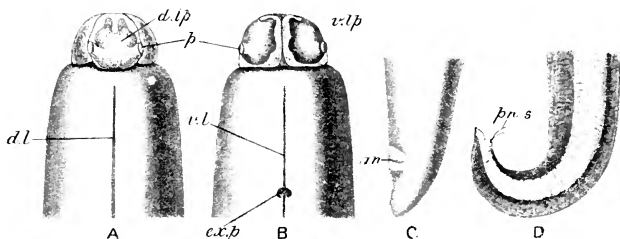

FIG. 242.—*Ascaris lumbricoides*. *A*, anterior end from above; *B*, the same from below; *C*, posterior end of female, *D*, of male, side view. *an.* anus; *d. lp.* dorsal lip; *d. l.* dorsal line; *ex. p.* excretory pore; *p.* papillæ; *pn. s.* penial setæ; *v. l.* ventral line; *v. lp.* ventral lip. (After Leuckart.)

is sharply curved downwards (Fig. 242, *D*), while in the female (*C*) its ventral contour is nearly straight.

Body-wall.—The outer surface of the body is furnished by a delicate, transparent, elastic membrane, of a firm material of albuminoid composition, the *cuticle* (Fig. 243, *cu.*). It is divisible into several layers containing a system of fine vertical channels (*A. megalcephala*), and is wrinkled transversely, so as to give the animal a segmented appearance. Beneath the cuticle is a protoplasmic layer (*der. ephm.*) containing scattered nuclei and longitudinal fibres, and representing a *syncytial ectoderm*—*i.e.*, an ectoderm in which the cell-boundaries are not differentiated, and whose cellular nature is recognisable only by the nuclei. The cuticle is, as usual, a secretion of the ectoderm.

Beneath the ectoderm is a single layer of *muscular fibres* (*m.*), arranged longitudinally, and bounding the body-cavity. The structure of the muscles is very peculiar: each (Fig. 244, *A*) has

the form of a spindle, striated longitudinally, and produced on its inner face (*i.e.*, towards the body-cavity) into a large and almost bladder-like mass of protoplasm (*p.*) containing a nucleus (*nu.*). Apparently the whole of this structure is derived from a single cell, part of which has become differentiated into contractile substance (*c.*), the rest remaining protoplasmic. In transverse section the contractile portion (*B, c.*) has the form of a plate bent upon itself so as to be, as it were, wrapped round the protoplasmic portion (*p.*). The protoplasmic processes project to a greater or less extent into the body-cavity, sometimes practically obliterating it, and are produced into delicate filaments (*f.*) which take a transverse

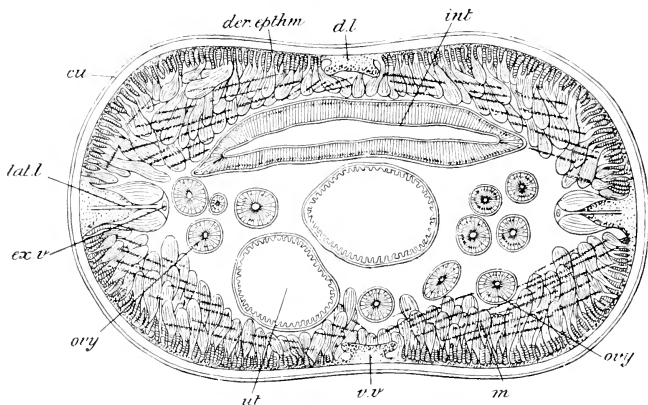

FIG. 243.—*Ascaris lumbricoides*, transverse section. *cu.* cuticle; *d.l.* dorsal line; *der. ephm.* deric epithelium or epidermis; *ex v.* excretory vessel; *int.* intestine; *lat. l.* lateral line; *m.* muscular layer; *ovy.* ovary; *ut.* uterus; *v.v.* ventral line. (After Vogt and Yung.)

direction, and are mostly inserted into the dorsal and ventral lines.

The muscular layer is not continuous, but is divided into four longitudinal bands or quadrants, two dorso-lateral and two ventro-lateral, owing to the fact that at the dorsal, ventral, and lateral lines the ectoderm undergoes a great thickening and projects inwards, between the muscles, in the form of four longitudinal ridges (Fig. 243, *d.l.*, *v.v.*, *lat. l.*). The ridges are composed of fibres continuous with the fibres of the ectoderm. It is this arrangement that gives rise to the lines seen externally. The ridges forming the lateral lines are much more prominent than the other two.

Digestive Organs.—The mouth leads into the anterior division of the enteric canal, the *pharynx, stomodæum* or *œsophagus* (Fig. 245, *ph.*): its walls are very muscular, its cavity is three-rayed in cross-

section, and it is lined by a cuticle secreted from the epithelial layer and continuous, at the mouth, with that of the body-wall. Posteriorly the pharynx opens into the *intestine* (*int.*), a thin-walled tube, flattened from above downwards, and formed of a layer of epithelial cells bounded both internally and externally by a delicate cuticle: it has no muscular layer (Fig. 243, *int.*). Posteriorly the intestine narrows considerably to form the short *rectum*, which has a few muscular fibres in its walls and opens externally by the anus (Fig. 245, *an.*). The food, consisting of the semi-fluid contents of the intestine of the host, is sucked in by movements of the pharynx, and is then absorbed into the system through the walls of the intestine. The food being already digested by the host, there is no need of digestive gland cells, such as occur in animals which prepare their own food for absorption.

It will be noticed that in the above description the pharynx is also called stomodæum. This must not be taken to indicate that the two terms are synonymous, but that, in the present instance, the epithelial lining of the pharynx is derived from the ectoderm, being formed as an in-

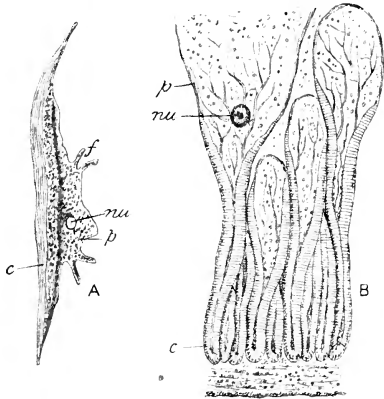

FIG. 244.—*Ascaris lumbricoides*. *A*, a single muscle fibre; *B*, several fibres in transverse section with portion of ectoderm (below). *c*, contractile substance; *f*, fibrous processes; *nu*, nucleus; *p*, protoplasmic portion. (After Leuckart.)

turned portion of the outer layer of the body-wall. The epithelium of the intestine, on the other hand, is endodermal, this portion of the canal being derived from the archenteron of the embryo.

Between the enteric canal and the body-wall is a distinct space, the **body-cavity**, containing a clear fluid and more or less encroached upon by the protoplasmic processes of the muscle-cells. The cavity is bounded externally by these processes, internally by the outer cuticle of the intestine: there is no trace of epithelial lining such as occurs in most of the higher animals. The body-cavity of the Nematode, in fact, does not exactly correspond to the cœlome to be met with in most higher phyla. It is not to be derived, directly or indirectly, from the archenteron of the embryo, and it does not lie, like a true cœlome, between layers of the mesoderm.

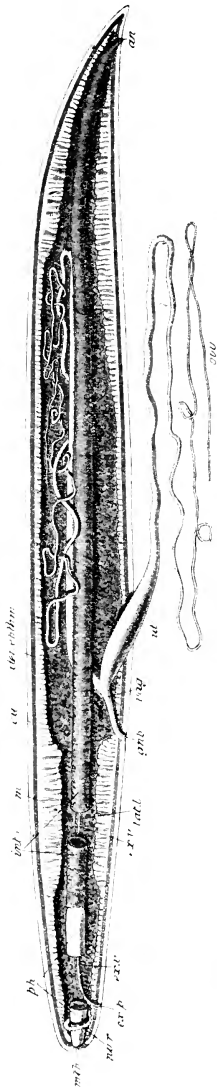

FIG. 245.—*Ascaris lumbricoides*. Semi-diagrammatic dissection of the female. *an*, anus; *cu*, cuticle; *der. epith.*, dermic epithelium; *ex. p.*, excretory pore; *ex. v.*, excretory vessel; *gon. p.*, gonopore; *ov*, ovary, that of the right side in situ, the left spread out; *ph*, pharynx, partly cut away; *lat. l.*, lateral line; *m*, muscular layer; *mth*, mouth; *nv. r.*, nervous ring; *ov*, ovary, partly cut away; *ut*, uterus; *vag.*, vagina.

The **excretory system** consists of two longitudinal canals (*ex. v.*), one in each lateral line. Anteriorly these pass to the ventral surface, unite with one another, and open by the minute excretory pore (*ex. p.*) already noticed. The system is not ciliated, contains no flame-cells, and has no internal openings. Each canal is an excavation in a single enormously elongated cell with a single nucleus.

The **nervous system** consists of a ring (*nv. r.*) surrounding the pharynx and giving off six nerves forwards and six backwards (Fig. 246). Of the latter two are of considerable size, and run in the dorsal and ventral lines respectively (*dln.*, *vlv.*). They are connected with one another by transverse commissures (*c.*), and the ventral nerve swells into a ganglion just in front of the anus. The pharyngeal nerve-ring contains nerve-cells, and its ventral portion (*un.*) is thickened and ganglion-like. The only sense-organs are little elevations, the *sensory papillæ* (Fig. 242, *p.*), on the lips.

The **reproductive organs** are formed on a peculiar and very characteristic pattern. The *testis* (Fig. 247, *ts.*) is a long, coiled thread, about the thickness of fine sewing-cotton, and occupying a considerable portion of the body-cavity. At its posterior end it is continuous with the *vas deferens*, the two passing insensibly into one another so that the junction is not visible externally. The *vas deferens*, in its turn, becomes continuous with a wide canal, the *vesicula seminalis* (*vs. sem.*) which opens by a short, narrow muscular tube, the *ductus ejaculatorius*, into

the rectum. Behind the rectum, and opening into its dorsal wall, are paired muscular sacs (*s.*), containing the *penial setæ* (*pn. s.*) already noticed. The anterior end of the testis consists of a solid mass of sex-cells; passing backwards there is found a cord or *rachis* occupying the axis of the tube and having the sperm-cells attached to it; still further back the sperms become gradually differentiated, and are finally set free in the vas deferens. The sperms are peculiar rounded cells (Fig. 23, p. 31, *c. d. e.*); when transferred into the body of the female they exhibit amœboid movements, but as long as they remain in the male ducts they are non-motile: they have no trace at any stage of the characteristic tail of the typical sperm. In this connection it may be mentioned that the tissues of *Ascaris* are remarkable for the total *absence of cilia*.

The organs of the female (Fig. 245) resemble those of the male, but are double instead of single. There are two coiled, thread-like ovaries (*ovy.*), each passing insensibly into a uterus (*ut.*). In the ovary, as in the testis, the eggs are developed in connection with an axial cord or rachis. The two uteri unite in a short muscular vagina (*vag.*) which opens, as already seen, on the ventral surface of the body (*gnp.*) at about one-third of the entire length from the head.

Development.—The eggs are produced in immense numbers—at the rate, it has been reckoned, of about 15,000 a day. They are fertilised in the upper part of the uterus, each becoming enclosed

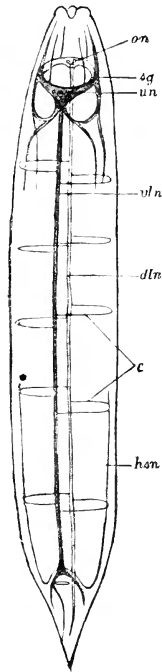

FIG. 246.—Diagram of nervous system of Nematoda. *c.* commissures; *dtn.* dorsal nerve; *hsn.* posterior lateral nerve; *on.* upper and *un.* under portion of nerving; *sg.* lateral swellings; *vn.* ventral nerve. (From Lang, after Bütschli.)

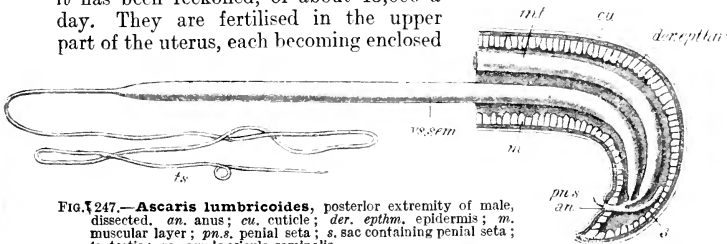

FIG. 247.—*Ascaris lumbricoides*, posterior extremity of male, dissected. *an.* anus; *cu.* cuticle; *der. ephm.* epidermis; *m.* muscular layer; *pn. s.* penial seta; *s.* sac containing penial seta; *ts.* testis; *vs. sem.* vesicula seminalis.

in a chitinous egg-shell, and are passed out of the body of the host with its fæces. The results of experiments render it probable that infection is direct, without intermediate host, the embryo-containing eggs being taken, in water, or in soil accidentally swallowed, into the intestine of a new human host, in which the embryos, escaping from the eggs, become mature.

2. DISTINCTIVE CHARACTERS AND CLASSIFICATION.

The Nematoda are Nemathelminthes having a cylindrical body of great length in proportion to its diameter, and pointed at both ends. The body-wall consists of a tough external cuticle, an ectoderm in the form of a syncytium or protoplasmic layer containing nuclei and rarely exhibiting cell-structure, and a single layer of longitudinal muscular fibres which are interrupted along one or more (dorsal, ventral, and lateral) lines. The body-wall encloses a body-cavity containing a clear fluid, and more or less encroached upon by processes of the muscle-cells or other mesodermal tissues. The enteric canal is straight, and consists of pharynx, intestine, and rectum: the pharynx is a stomodæum. The mouth is anterior and terminal, the anus ventral and situated a short distance from the posterior end. Excretory canals, running in the lateral lines, are usually present. The nervous system consists of a pharyngeal ring containing nerve-cells and giving off nerves forwards and backwards: of those passing backwards there is either a single ventral-cord, or there are two chief cords, respectively dorsal and ventral, of considerable size and extending to the posterior end of the body. The Nematoda are in nearly all cases dioecious: eggs are produced in immense numbers, and are impregnated within the body of the female. The sperms are non-motile, or perform amœboid movements only after entering the female organs. Cilia are wholly absent.

A large proportion of Nematoda are free-living, spending their whole life in fresh- or salt-water, damp earth, decaying matter, etc.; the remainder are parasitic during the whole or a part of life.

The class is divided into two orders.

ORDER I.—NEMATOIDEA.

Nematoda in which the sub-cuticle is a nucleated protoplasmic layer without cell-outlines. Two chief nerve-cords are given off backwards from the pharyngeal ring and lie in the dorsal and ventral lines. There are two excretory canals lying in the lateral lines and opening anteriorly and ventrally. The gonads are continuous with their ducts, and consist of long, more or less convoluted cords. This order includes nearly the whole of the free-living Nematodes as well as the large majority of parasitic forms.

ORDER 2.—NEMATOMORPHA.

Nematoda in which the sub-cuticle consists of a layer of distinct cells and the pharyngeal nerve-ring sends off a single large ventral nerve-cord composed of three parallel strands well supplied with nerve-cells. There are no excretory canals. The reproductive products are discharged into the body-cavity. This order includes a small number of greatly elongated, thread-like worms (species of the genus *Gordius*), which are parasitic in the asexual, free-living in the sexual stage; and is usually regarded as comprising also the genus *Nectonema*, which has only been found swimming in the sea.

Systematic Position of the Example.

Ascaris lumbricoides is one of many species of the genus *Ascaris*, and belongs to the family *Ascaridæ* of the order *Nematoidea*.

The absence of an epithelial lining to the body-cavity, and the presence of elongated gonads continuous with their ducts, indicate its position as one of the *Nematoidea*. Among the numerous families constituting this order, the *Ascaridæ* are distinguished by the possession of three lips furnished with papillæ, and by the body of the male being curved ventrally and being provided with penial setæ. *Ascaris* is distinguished from the other genera of the family by the absence of a bulb-like enlargement at the posterior end of the pharynx, by the posterior extremity of the body having the form of a short blunt cone, and by the presence of two penial setæ in the male.

3. GENERAL ORGANISATION.

External Characters.—The Nematoda vary much in size: the little *Anguillula*, one of the commonest of aquatic animals, does not exceed 1 mm. in length, while the dreaded parasite known as the Guinea-worm (*Filaria medinensis*) is sometimes as much as 2 metres (6 feet) long. The length is always great in proportion to the diameter, and the body is always bluntly pointed at the anterior end and either pointed or forked posteriorly. One of the most striking cases of disproportion between length and breadth is exhibited by the free, sexual form of *Gordius*, one of the *Nematomorpha*; it is found in earth or water and resembles a tangle of brown string, the length being frequently as much as 15 or 16 cm. while the diameter does not exceed 0.5 mm.

Body-wall.—The body is always covered by a cuticle secreted by the deric epithelium or external ectoderm (*sub-cuticle*). The cuticle is usually smooth, sometimes beset with spines or hooks, sometimes ringed. In certain species it is raised up to form a pair of lateral fin-like folds running along the sides of the body for some distance. *Nectonema* differs from all the rest in having two rows

of fine bristles running along either side of the elongated body. A regular ecdysis or moulting of the cuticle at intervals takes place in many Nematodes. The sub-cuticle in most cases takes the form of a protoplasmic layer with scattered nuclei; but in the Nematomorpha (Fig. 250, *ep.*) it consists of a true epithelium—a single layer of cells the outlines of which are quite distinct.

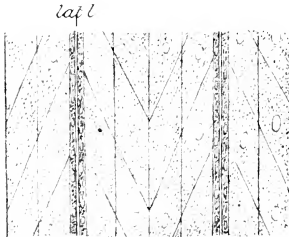

FIG. 248.—The body-wall of a platymyarian Nematode, spread out. *lat. l.* lateral lines. (After Leuckart.)

Beneath the ectoderm is a muscular layer, which in many genera has the same structure as in *Ascaris*, *i.e.*, consists of a single layer of longitudinal fibres, interrupted at the dorsal, ventral, and lateral lines, each fibre being spindle-shaped and produced into a protoplasmic process which projects into the body-cavity. But in many forms (*e.g.*, *Strongylus*) the muscle-cells are flat rhomboidal plates (Fig. 248), and each quadrant contains only two rows, the total number in a transverse

section being therefore eight. In *Gordius* the muscles are interrupted along the ventral line only (Fig. 250), and in *Nectonema* only along the dorsal and ventral lines, the lateral lines being absent. In *Gordius*, but not in *Nectonema*, the protoplasmic portions of the muscle-cells are directed outwards, not inwards.

Enteric Canal.—The mouth is frequently armed with spines (Fig. 249, *C*), by means of which the worms draw blood from the

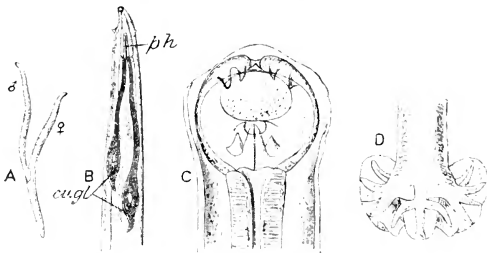

FIG. 249.—*Dochmius duodenalis*. *A*, male and female in coitu. *B*, anterior end, showing—*cu. gl.* cervical glands; *ph.* pharynx. *C*, mouth with spines; *D*, posterior end of male, with bursa. (After Leuckart.)

intestinal blood-vessels of their host. Many free-living forms have a sharp stylet for piercing the tissues of the plants on which they feed, and a suctorial apparatus for absorbing the juices. The posterior end of the œsophagus is often dilated to form a globular

chamber with muscular walls, the *gizzard* (Fig. 251, *gz.*). The only specially interesting variation in the structure of the intestine is that occurring in *Trichinella* (Fig. 253), one of the Nematodes parasitic in Man, in which this part of the enteric canal consists of a single row of perforated cells (*zh*): the lumen is therefore not *inter-cellular* but *intra-cellular*, like the gullet of an Infusor. In the sexual stage of *Gordius* and in *Nectonema* the enteric canal undergoes more or less complete degeneration, and in several other genera there is no anus. The alimentary canal in some rare cases has hollow appendages in the form of oesophageal glands or intestinal

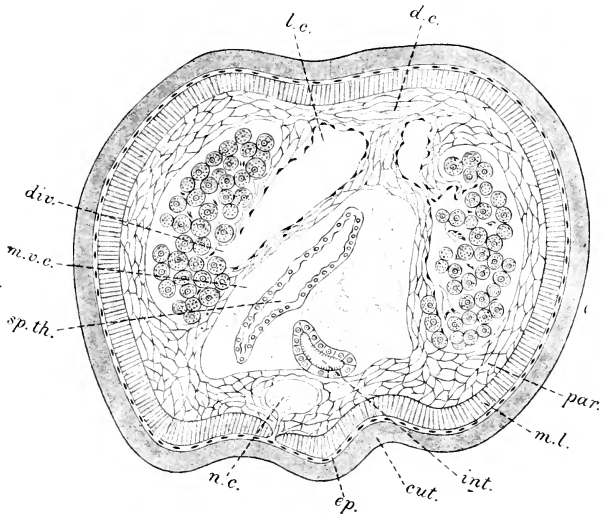

FIG. 250.—Transverse section of *Gordius* (female) in the posterior region. *cut.*, cuticle; *d. c.*, dorsal canal; *div.*, diverticulum of lateral canal; *ep.*, deric epithelium; *int.*, intestine; *l. c.*, lateral canal; *m. l.*, muscle layer; *m. v. c.*, median ventral canal; *n. c.*, nerve-cord; *par.*, parenchyma; *sp. th.*, spermatheca. (After Rauther.)

cæca. In *Dochmius* a pair of pear-shaped bodies of unknown function, the *cervical glands* (Fig. 249, *B, cv. gl.*), lie one on each side of the pharynx and probably open externally near the mouth.

In the Nematodea the **body-cavity** is always a single continuous chamber crossed in various directions by delicate fibres and without epithelial lining. In *Gordius* the body is solid in the larva, filled with polygonal cells (parenchyma), but fissures appear, and, increasing in extent, eventually give rise to extensive canal-like cavities—a median ventral and two lateral, with, in the female, a narrow median dorsal, separated from one another for the most

part by comparatively thin partitions of parenchyma sometimes termed mesenteries. The median ventral canal (Fig. 250, *m.v.c.*) of the body-cavity encloses the alimentary canal: the lateral canals (*l.c.*) are associated with the development of the reproductive apparatus. In the case of the lateral alone, and only in the female, is there an epithelial lining. In *Nectonema* the body-cavity is reduced in the female to a narrow space between the wall of the ovary and the muscular layer: in the male it is considerably wider.

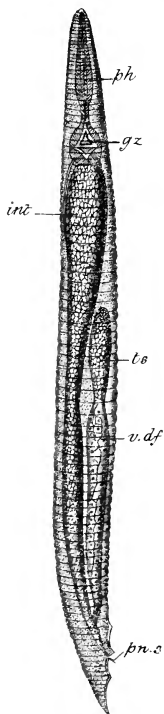

FIG. 251.—*Oxyuris*, from the right side. *gz.* gizzard; *int.* intestine; *ph.* pharynx; *pn.s.* penial setae; *ts.* testis; *v. df.* vas deferens. (From Shipley, after Gateb.)

In the Nematodea when definite **excretory organs** exist, they take the form of narrow longitudinal canals similar to those described as occurring in *Ascaris*—each canal being an excavation in a single enormously elongated cell, and the system having a median ventral opening. Sometimes only one of the canals is developed. Flame-cells are never present. In the Nematomorpha such a system does not occur.

In the Nematodea the **nervous system** has the structure already described in *Ascaris*; it is, however, apparently absent in some free-living forms. But in *Gordius* it is much more highly developed: the pharyngeal ring (brain) is of great thickness and is continued into a single ventral cord composed of three strands containing nerve-cells. In *Nectonema* there is a similar ring and three-stranded nerve-cord, and in addition a large anal ganglion at the posterior end. **Eye-spots** have been described in the sexual form of *Gordius*.

The **reproductive organs** in all the Nematodea resemble those of *Ascaris*, the only important variation depending upon the fact that in the smaller forms the entire genital tube (gonad *plus* gonoduct) is short and not coiled (Fig. 251, *ts.* and *v. df.*). A few forms are hermaphrodite, but, instead of having a double set of reproductive organs, as in Platyhelminthes, organs of the ordinary female nematode-type are present, and the gonads produce first sperms and afterwards ova. Such animals are said to be *protandrous* (male products ripen first), and self-impregnation is as effectually prevented as if the organs of the two sexes were distinct.

In *Gordius* and *Nectonema* (Nematomorpha) the sexes are

distinct. In the female *Gordius* (Fig. 252, *C*) the lateral canals of the body-cavity (*ut.*) are modified to act as ovaries and oviducts. They give off a series of regularly arranged lateral diverticula from the cells lining which the ova are derived (Fig. 252, *A*, and Fig. 250, *div.*). Behind, each of these lateral canals becomes a narrow tube or oviduct. These open into a median chamber with glandular walls, the uterus (*vag.*), and into this there also opens the duct of a spermatheca or receptaculum seminis (*spth.*) for the reception and storage of the sperms received in copulation. The uterus is continued backwards by an atrial cavity opening along with the intestine in a cloacal aperture (Fig. 252, *gnp.*) at the posterior end of the body. In the male (Fig. 252, *B*) the lateral canals are unsegmented

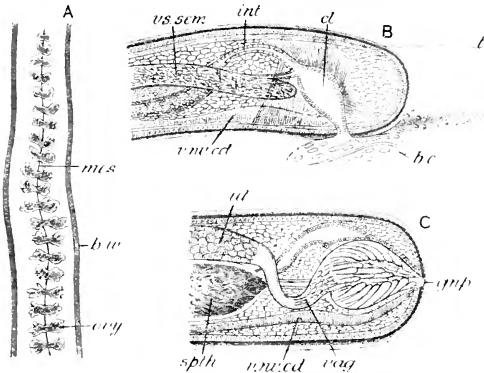

FIG. 252.—*Gordius*. A, horizontal section of female, showing ovaries (*ovg*) attached to mesentery (*mes.*); *b. w.* body-wall. B, posterior extremity of male, sagittal section. *b. c.* coagulated mass of sperms (?); *cl.* cloaca; *int.* intestine; *t.* tail; *v. n. c.* ventral nerve-cord; *vs. sem.* vesicula seminalis or sperm-sac. C, posterior extremity of female, sagittal section. *gnp.* cloacal aperture; *spth.* spermatheca; *ut.* lateral canal; *vag.* uterus, followed posteriorly by atrium; *v. n. c.* ventral nerve-cord. (After Vejdowsky.)

tubes—testes or sperm-sacs (*vs. sem.*)—from the cells bordering a portion of which sperms are developed. From each of these at its posterior end a narrow vas deferens passes backwards to open into the cloaca (*cl.*). The latter, with a ventrally-placed opening, has a muscular wall and is probably capable of being everted to serve as a penis. In *Nectonema* the entire genital apparatus is simpler and the ovary is not segmented.

The development of Nematodes begins in some cases only after the eggs have been laid: such eggs are almost always provided with thick shells. In other cases the earlier stages, and sometimes even considerably more advanced stages, are passed through in the uterus of the mother, and a few (*Trichinella spiralis*, species of

Ascaris, species of *Filaria* and others) are viviparous. Segmentation is complete and usually unequal. In *Ascaris* the ovum divides first into two cells, a dorsal and a ventral. The former becomes subdivided into two—anterior and posterior—and of these the latter undergoes further division into two—a right and a left. The ventral cell of the two-celled stage gives rise to a median row of four cells of which the second becomes differentiated as the *primordial endoderm cell*, which gives rise to the entire endodermal layer of the mesenteron. The rest of the cells of this stage go to form the ectoderm, the mesoderm and the sexual cells. A segmentation-cavity is sometimes present, sometimes absent. The descendants of the original dorsal cell undergo repeated division to form a layer of numerous small cells (*primitive ectoderm*) that grows over the rest, bringing about a kind of epibolic gastrulation. Of the ventral row of four cells the most anterior divides into two pairs of cells destined to give rise to the *mesoderm bands* as well as the ectoderm of the stomodæum; the second, as already stated, is the primordial endoderm cell; the third divides transversely into two *primordial sexual cells*, and the last divides into four *caudal cells*. These last undergo rapid multiplication and give rise to the *secondary ectoderm*, which pushes forwards the primary ectoderm as it spreads over the surface and eventually covers the entire embryo as the integumentary layer, the primitive ectoderm, now sunk beneath the surface, probably going to form the nervous system, and some cells given off from it contributing to the formation of the mesoderm. The two mesoderm bands divide each into two—dorsal and ventral—and produce the muscular layer of the body-wall. In certain viviparous forms the elongation of the embryo into the vermiform shape is preceded in the uterus of the mother by a flat disc-like stage, and the gastrulation is completed by the curving downwards and inwards of the thin edges of the disc until they come in contact and fuse in the middle line ventrally.

Many of the Nematoda have a curious and complex **life-history**: a few examples will be selected for description.

Rhabdonema nigrovenosum lives, in the sexual condition, in the lungs of Frogs and Toads: it is remarkable among members of the class in being hermaphrodite. The eggs are laid and the embryos pass from the lungs into the enteric canal of the host, are expelled with its fæces, and develop in water into a sexual Nematode, called the *Rhabditis*-form, in which the sexes are separate: in this the fertilised eggs develop in the body of the female, and, when fully formed, make their way through the wall of the uterus and proceed to devour the whole of the maternal tissues, leaving nothing but the cuticle. Being set free, they live in mud until they succeed in gaining access to a frog's mouth, when they pass into the lung, develop hermaphrodite reproductive organs, and so re-commence the cycle. It will be seen that we

have here a peculiar form of alternation of generations, distinguished not by the alternation of a sexual with an asexual form (metagenesis) as in Hydrozoa, but by the alternation of a hermaphrodite with a dioecious form—a variety of *heterogamy* (page 41).

One of the most terrible parasites of Man is *Trichinella spiralis* (Fig. 253), a minute worm, the male (*C*) a little over 1 mm. ($\frac{1}{16}$ in.) in length, the female (*B*) about 3 mm. ($\frac{1}{8}$ in.). In the adult or sexual condition it lives in the intestine of Man, the Pig, and other Mammals.

The adult females, which are viviparous, leave the cavity of the intestine and bore into its wall, usually reaching the interior of one of the lacteal vessels of the lymphatic system. Here they deposit their young (*B, e*) to the number of as many as a thousand or more at a time. These are carried passively in the stream of lymph, perhaps ultimately in the bloodstream, and thus distributed throughout the body. Eventually they travel into the system of voluntary muscles, such as those of the limbs, back, tongue, etc. Each worm then penetrates the sarcolemma of a muscle-fibre and coils itself up in the muscle substance (*A*); a spindle-shaped cyst (*cy.*) is formed round it, and the muscle

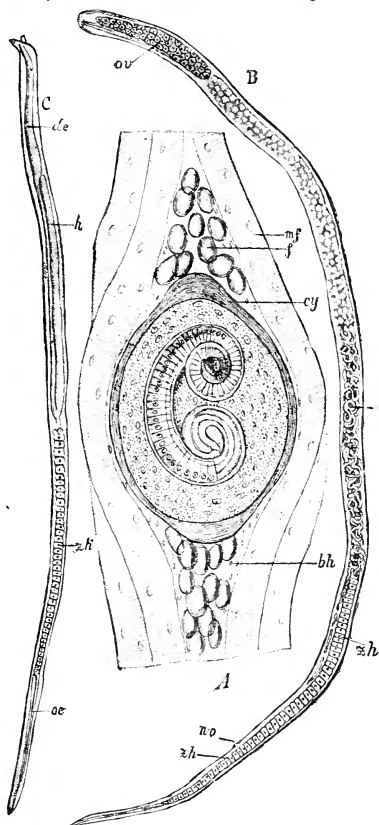

Fig. 253.—*Trichinella spiralis*. *A*, encysted form, in muscle of host; *B*, female; *C*, male. *bh*, connective-tissue envelope; *cy*, cyst; *de*, embryo; *f*, fat-globules; *h*, testis; *m.f.*, muscle-fibre; *oe*, pharynx; *ov*, ovary; *wo*, gonopore; *zk*, perforated cells of intestine. (From Lang's *Comparative Anatomy*, after Claus.)

undergoes more or less degeneration. This process gives rise to various morbid symptoms in the host, but after some months the cysts become calcified, and the danger to the infected individual is over. The flesh of a "trichinised" human subject has been estimated to contain 100,000,000 encysted worms, and that of an infected pig 85,000 to the ounce. In order that further development of the encysted and sexless *Trichinæ* should take place, it is necessary for the infected flesh of the host to be eaten by another animal in which the worm is capable of living, *e.g.*, that of Man by a Pig or Rat, or that of a Pig by Man. When this is done the cysts are dissolved by the digestive juices, the worms escape, develop reproductive organs, and copulate, the young migrating into the muscles and producing the disease as before. The result of eating an ounce of "trichinised" or "measly" pork, improperly cooked, might be the liberation in the human intestine of perhaps 80,000 worms; and, if half of these were females, each producing 1,000 embryos, some 40,000,000 worms would shortly begin to migrate into the muscles, and produce the various symptoms of "trichiniasis."

It will be noted that in this case the parasite is able to exist in various hosts, and that both sexual and asexual stages are passed through in the same host, dispersal of the species taking place by the flesh of an infected animal being eaten by another, either of the same or of a different species.

The female Guinea-worm (*Filaria medinensis*) attains a length of 30–200 cm. (1–6 ft.), and lives in the subcutaneous connective-tissue of Man. The eggs develop in the uterus, and the new-born young pass out of the body of the host through abscesses caused by the presence of the parasite. If, as must often be the case, they escape into water, they make their way into the body of a Water-flea (*Cyclops*), which is the intermediate host, and in this condition probably reach their human host once more in his unfiltered drinking-water. *Filaria bancrofti* and other species are, in the larval condition, parasites in the blood of man. The adult females of *F. bancrofti* live normally in the lymphatic vessels. They are viviparous, and the young when they escape reach the blood and are thus distributed. Normally they are to be found in the peripheral vessels only at night-time, when the superficial vessels are more dilated and thus permit of their passage. They are transmitted from one human host to another by the agency of mosquitoes, which act as intermediate hosts. *F. bancrofti* is very widely distributed in tropical countries, and is the cause of a disease called *filariasis*, with a variety of symptoms—such as anæmia, lymphatic tumours, elephantiasis.

CLASS II.—ACANTHOCEPHALA.

This class contains a number of genera of parasitic worms, of which *Echinorhynchus* is the chief. The present section will be devoted to this genus, a not uncommon parasite in the intestine of Mammals, Birds, Reptiles, Amphibians, and Fishes. The largest species, *E. (Gigantorhynchus) gigas*, is found in the Pig (Fig. 254, A), and has once been recorded in the human subject: it may attain, in the female, a length of 50 cm., or more than half a yard. Most species are small, not exceeding 1 cm. in length.

External Characters.—The body is cylindrical, and ends in front in a protrusible portion, the *proboscis* (A, p., B, pr.), which is cylindrical and is covered with many rows of recurved chitinous hooks. The worm lies with the proboscis sunk in the wall of the intestine of its host, which is sometimes riddled with holes formed in this way. In some species there is a distinct neck (B, n.) between the proboscis and the trunk, and there may be a globular dilatation at the anterior end of the neck. At the hinder end of the body is a single aperture, the gonopore or reproductive aperture (*gnp.*): connected

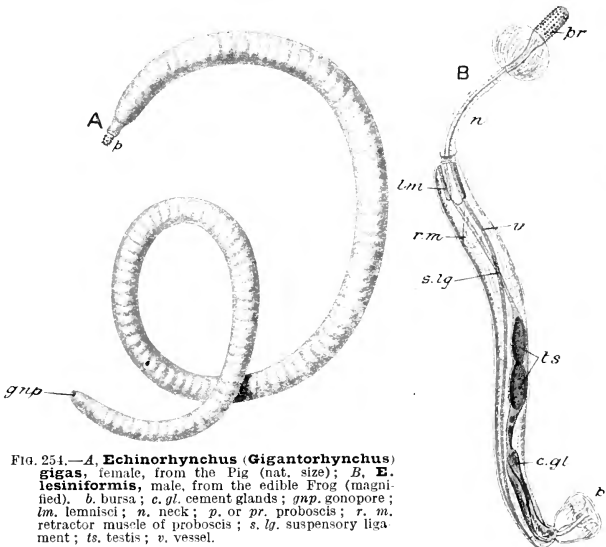

FIG. 254.—A, *Echinorhynchus (Gigantorhynchus) gigas*, female, from the Pig (nat. size); B, *E. lesiniformis*, male, from the edible Frog (magnified). b. bursa; c. gl. cement glands; gnp. gonopore; lm. lemnisci; n. neck; p. or pr. proboscis; r. m. retractor muscle of proboscis; s. lg. suspensory ligament; ts. testis; v. vessel.

with this, in the male, is a protrusible, bell-like structure, the *bursa* (b.), which acts as a copulatory organ, like the somewhat similar organ in certain Nematoda. There is no trace of mouth, anus, or excretory pore.

The **body-wall** is covered with a stout cuticle, beneath which is a striated protoplasmic layer, probably representing the ectoderm. Then comes a layer of transverse, and then one of longitudinal muscles. The body-wall thus constituted encloses a spacious **body-cavity** or **cœlome** containing a clear fluid.

In correspondence with the absence of mouth and anus there is no trace of enteric canal, the Acanthocephala resembling in this respect the Cestoda, the only other class of Metazoa which is entirely anenterous. Food is thus, as in tapeworms, taken entirely by absorption by the general surface of the body.

The proximal end of the *proboscis* is contained in a muscular sheath sunk in the anterior end of the trunk, and is provided with four retractor muscles (Fig. 254, *r.m.*). The muscles of the sheath are circular and act as protractors. At the sides of the base of the proboscis two club-shaped organs, the *lemnisci* (*lm.*), hang down into the body-cavity. Their function is quite unknown, but they have been compared with the cervical glands of certain Nematodes (p. 301).

In the body-wall run two longitudinal *vessels* (*v.*) containing a granular fluid, and connected with a network of fine canals in the proboscis, bursa, etc. The function of these vessels is not known with certainty: they may have to do with the absorption and circulation of nourishment.

The **central nervous system** (Fig. 255, *nv.*) is represented by a single large ganglion placed at the base of the proboscis, and sending off nerves in various directions. In the male there are also two ganglia supplying the reproductive organs. Organs of sense are wholly absent.

A pair of remarkable **excretory organs** or **nephridia** (Fig. 257) have been found to occur in *Echinorhynchus gigas*. These consist of a pair of ramified protoplasmic masses situated in the body-cavity at the posterior end, near the genital aperture.

In the interior is a system of branching canals, the terminal branches of which, each contained in one of the terminal lobes of the tree-like nephridium, are provided with

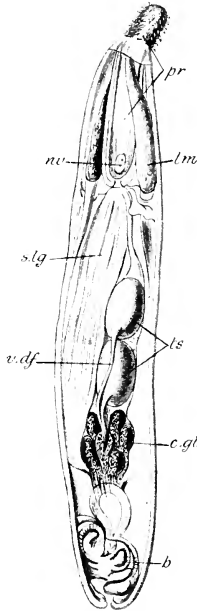

FIG. 255.—*Echinorhynchus gigas*. Dissection of male. *b.* bursa; *c. gl.* cement glands; *lm.* lemnisci; *nv.* nerve-ganglion; *pr.* proboscis; *s. lg.* suspensory ligament; *ts.* testis; *r. df.* vas deferens. (After Leuckart.)

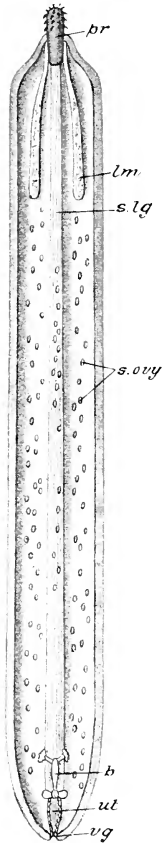

FIG. 256.—*Echinorhynchus gigas*. Dissection of female (semi-diagrammatic). *b.* bell; *lm.* lemnisci; *pr.* proboscis; *s. ovy.* swimming ovaries; *ut.* uterus; *vg.* vagina.

ciliary flames; at the end of each lobe are a number of fine perforations placing the contained canal in communication with the body-cavity. The stalk of each nephridium contains a single main canal; these unite to form a wide median dorsal channel which opens behind in the female into the unpaired portion of the oviduct and in the male into the ejaculatory duct.

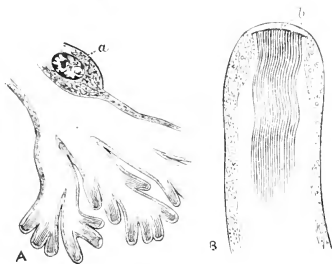

FIG. 257.—A, longitudinal section through the terminal twigs of the nephridia of *Echinorhynchus gigas*; highly magnified. *a*, nucleus. B, a terminal twig more highly magnified. *b*, the porous membrane. (From Shipley, after Kaiser.)

connected with the suspensory ligament. From each a furnished with several *vesiculae seminiales* or sacs for the storage of spermatic fluid, passes backwards and unites with its fellow to form an *ejaculatory duct*, with which are connected about half a dozen *cement glands* (*c. gl.*). The ejaculatory duct opens into the bursa or bell-like copulatory organ (*b*), and has at its opening a small papilla acting as a penis.

In the female the ovary is connected with the suspensory ligament (Figs. 256 and 258, *s.lg.*). When ripe, groups of ova—known as the “swimming ovaries” (*s. ovy.*)—become detached and swim freely in the body-cavity, where they are impregnated. The ducts are very peculiar. Connected with the end of the suspensory ligament is a muscular *uterine bell* (*b.*), widely open anteriorly (Fig. 258, *x.*) into the coelome, and having towards its posterior end a small aperture or a pair of small apertures (*y.*), also communicating with the coelome. The bell is connected with a narrow double passage leading to a uterus (*ut.*), which itself opens by the genital aperture at the posterior end of the body. The uterine bell performs rhythmical swallowing movements, and as the eggs—containing partly developed embryos—float in the coelome they are swallowed by the bell. The immature eggs, which are globular, are passed back into the coelome through the posterior aperture (*y.*) of the bell; but the mature eggs, which are spindle-shaped and covered with a chitinous investment, make their way from the bell to the uterus through the narrow passages, and so to the vagina.

The early stages of development take place in the coelome. Segmentation is regular, and a peculiar form of gastrula is produced, having neither archenteron nor blastocoel—in other words the ectoderm and endoderm are in close contact with one another, and no

The greater part of the body-cavity is occupied by the **reproductive organs**. The sexes are separate, and the female is larger than the male. In both sexes the gonads and their ducts are connected with a great *suspensory ligament* (*s.lg.*), which extends backwards from the end of the proboscis-sheath.

In the male there are two ovoidal testes (Fig. 255, *ts.*) connected with the



FIG. 258.—Female organs of *Echinorhynchus*. *b.* uterine bell; *s. lg.* suspensory ligament; *ut.* uterus; *vg.* vagina; *x.* *y.* apertures of bell; *z.* apertures leading from bell to uterus. (After Hertwig.)

central cavity is enclosed by the latter. The ectoderm layer, which is devoid of cell-limits, secretes a cuticular membrane investing the embryo: then a second membrane is formed within the first, and a third within the second: the embryo thus comes to be enclosed in a triple case (Fig. 259), which differs from an egg-shell in being formed by the developing ectoderm. At what will become the anterior end chitinous hooks appear.

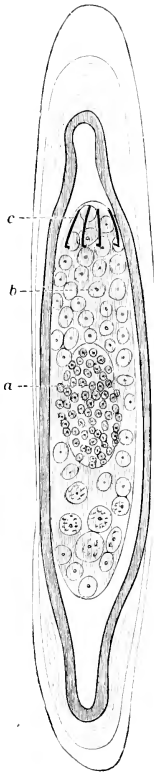

FIG. 259.—Egg of *Echinorhynchus acus*, enclosed in a triple case; highly magnified. *a.* endoderm; *b.* ectoderm; *c.* chitinous hooks. (From Shipley, after Hamann.)

At about this period the embryo is born, and reaching the intestine of the host, is extruded with its faeces. Its further development depends upon its being swallowed by an intermediate host, in the case of *E. gigas* of the Pig is a maggot, the larva of a Beetle, *Cetonia aurata*. The Echinorhynchi of fresh-water Fish have for their intermediate host certain small fresh-water Crustacea belonging to the genera *Gammarus* and *Asellus*.

Having reached the intestine of the intermediate host, the chitinous embryonic membranes are dissolved by its digestive juices, and the embryo either fixes itself to the wall of the intestine or makes its way into the coelome; in either case it soon begins to undergo further development. The endoderm, hitherto a solid mass of cells, undergoes a process of splitting, becoming divided into an outer layer in contact with the ectoderm and a solid central axis. The latter gives rise to the reproductive organs and the suspensory ligament, the outer layer to an epithelium, from which the body-muscles arise; the cavity formed by the splitting of the endoderm is the coelome. Part of the proboscis and its sheath are also of endodermal origin. The ectoderm gives rise to the protoplasmic layer of the body-wall, to the whole system of vessels, and to the lemnisci. The larval cuticle is thrown off and a new one formed. The larva reaches adult proportions and attains sexual maturity only if the intermediate host is eaten by the permanent host.

CLASS III.—CHÆTOGNATHA.

The present group, like that just discussed, is a very small one, containing only three genera (*Sagitta*, *Spadella* and *Krohnia*) of curious arrow-shaped worms, all but one species of which are pelagic.

External Characters.—The body (Fig. 260) is elongated and nearly cylindrical, and is divided into *head*, *trunk* and *tail*, the head being marked off by its somewhat rounded form, while the junction of trunk and tail is indicated by the ventrally placed anus (*a*). The tail bears a horizontal expansion, or *caudal fin* (*s. fl.*), and there are also horizontal *lateral fins* (*fl.*)—a single pair in *Spadella*, two pairs in *Sagitta*.

Body-wall.—There is no cuticle, but the outer layer of the body-wall is formed by an epidermis or deric epithelium (Fig. 261, *d. ephm*), which, instead of being syncytial as in the two preceding classes, is formed of several layers of epithelial cells. Next comes a delicate *basement membrane*, and then

a layer of muscles (*m.*), the fibres of which are striated and disposed longitudinally in four bands—two dorso-lateral and two ventro-lateral—an arrangement which recalls that of the corresponding layer in Nematoda.

Enteric Canal.—The mouth (Fig. 260, *m.*) is a longitudinal slit-like aperture on the ventral surface of the head; on either side of it are several sickle-shaped chitinous hooks (Fig. 262, *gh.*) which are moved by muscles in a horizontal plane and serve as jaws. The anterior region of the head also bears spines, and is strengthened by chitinous plates and partly covered by a hood-like fold of the integument.

The mouth leads by a muscular *pharynx* or stomodæum into a straight *intestine* (*d.*), which extends through the trunk and opens by the anus (*a*) at the junction of trunk and tail.

Cœlome.—At the junction of the head with the trunk, and of the trunk with the tail, are transverse partitions or *septa*, dividing the cœlome into compartments. The trunk region of that cavity is further subdivided by two longitudinal partitions, the *dorsal* and *ventral mesenteries*, which respectively connect the dorsal and ventral surfaces of the intestine with the body-wall: the tail-region of the cœlome is similarly divided into right and left chambers by a longitudinal vertical partition (Fig. 261, *A* and *B*).

There is no trace of **vascular system** or of **excretory canals**. The **nervous system**, on the other hand, is much better developed than in either of the preceding classes, in accordance with a free life and active movements. On the dorsal side of the pharynx is a comparatively large *brain* (Fig. 262, *g*), which sends off on each side a long nerve-cord, the *œsophageal connective* (*sc.*). The two connectives sweep round the enteric canal and unite on the ventral surface, not far from the middle of the trunk, in an elongated *ventral ganglion* (Fig. 260, *bg.*), from which numerous nerves are given off. The brain sends nerves to the eyes (Fig. 262, *an.*) and to the olfactory organs (*ro.*), and is also connected with two pairs of ganglia in the head, which lie deeply sunk in the mesoderm: all the rest of the nervous system retains its primitive connection with the ectoderm.

Sensory Organs.—On the surface of the body are numerous little papillæ carrying stiff bristle-like processes, and probably serving as organs of touch. There are two eyes (Fig. 263), situated one on each side of the dorsal surface of the head: each is globular and contains three biconvex lenses (*l.*), separated by pigment (*p.*) and surrounded by rod-like sensory cells (*rz.*). Behind the head is a ring-like structure, of the nature of an annular ridge of peculiarly modified and in part ciliated cells (Fig. 262, *ro.*): to this an olfactory function has been assigned.

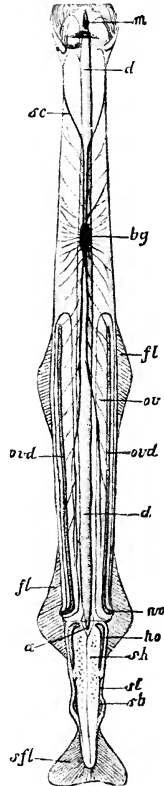

FIG. 260.—*Sagitta hexaptera*, from the ventral aspect. *a*, anus; *bg.*, ventral ganglion; *d.*, intestine; *fl.*, lateral fins; *ho.*, testis; *m.*, mouth; *ov.*, ovary; *ovd.*, oviduct; *sc.*, œsophageal connective; *sb.*, vesicula seminalis; *s. fl.*, tail fin; *sh.*, tail-cavity; *sl.*, spermiduct. (From Lang's *Comparative Anatomy*, after Hertwig.)

Reproduction.—The Chaetognatha are monœcious. The ovaries (Fig. 260, *ov.*, Fig. 261, *ovy.*) are elongated organs situated one on each side of the trunk-region of the cœlome, and opening by a narrow oviduct just in front of the posterior septum. The testes (Fig. 260, *ho.*, Fig. 261, *ts.*) are similarly situated in the tail-region of the cœlome, and have the form of narrow ridges

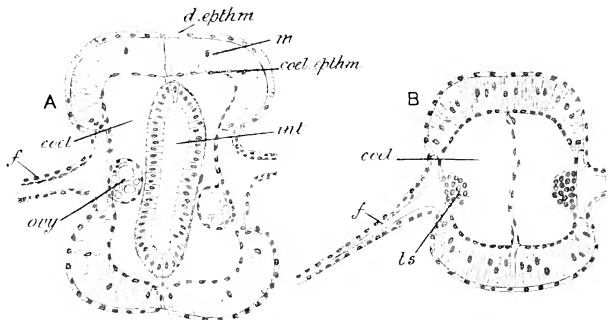

FIG. 261.—*Sagitta bipunctata*. Transverse sections, *A*, of trunk; *B*, of tail. *cœl.* cœlome; *cœl. ephm.* layer of nuclei of the muscle-cells formerly regarded as a cœlomic epithelium; *d. ephm.* deric epithelium, diagrammatically shown as a single layer; *f.* fin; *int.* intestine; *m.* muscles; *ovy.* ovary; *ts.* testis. (After Hertwig.)

from which immature seminal cells are given off and develop into sperms in the cœlome. The spermiducts or vasa deferentia are delicate tubes (*sl.*) opening at one end into the cœlome by a ciliated funnel-like extremity, and at the other end dilating into a reservoir or *vesicula seminalis* (*sb.*), which opens externally in the posterior region of the tail.

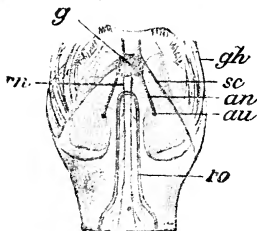

FIG. 262.—Head of *Sagitta bipunctata*, from above. *an.* optic nerve; *au.* eye; *g.* brain; *gh.* hooks; *m.* olfactory nerve; *ro.* olfactory organ; *sc.* oesophageal connective. (From Lang's *Comparative Anatomy*, after Hertwig.)

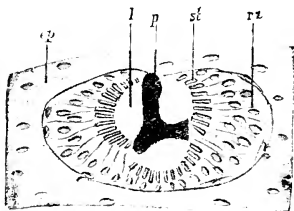

FIG. 263.—Section of eye of *Sagitta hexaptera*. *ep.* epiderm; *l.* lens; *p.* pigment; *rz.* visual cells; *st.* rods. (From Lang's *Comparative Anatomy*, after O. Hertwig.)

Development.—Internal impregnation takes place, and the oosperm, segmenting completely and regularly, forms a typical gastrula by invagination (Fig. 264, *A*). Two endoderm cells (*g.*) at the anterior end of the archenteron, *i.e.* the end opposite to the blastopore, soon increase greatly in size, and are the rudiments of the gonads. This precocious differentiation of the sex-cells is a point of considerable importance, as will be seen hereafter. Before long these cells migrate into the archenteron and divide, forming a group of four

cells (*B, g.*), two of which subsequently become the ovaries and two the testes. At the same time two folds of endoderm grow into the archenteron from its anterior end, partly dividing the cavity into three parts—a middle division or *mesenteron* (*d*)—the rudiment of the intestine, and two lateral divisions—the *mesentera*, or cœlomic sacs (*c. s.*)—which give rise to the right and left compartments of the cœlome of the trunk. From the latter are given off in front a pair of small head-cavities. Owing to the rapid elongation of the embryo in the stages following, all the cavities become for a time obliterated:

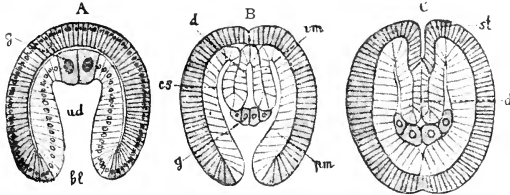

FIG. 264.—Three stages in the development of *Sagitta*.—*bl.* blastopore; *cs.* cœlomic sacs; *d.* mesenteron; *g.* sexual cells; *pm.* parietal layer of mesoderm; *st.* stomodæum; *vm.* visceral layer of mesoderm. (From Lang's *Comparative Anatomy*, after O. Hertwig.)

subsequently the cavities of the enteric canal and cœlomic sacs reappear; the tail-region of the body-cavity is formed from the posterior, undivided portion of the archenteron. The blastopore (*bl.*) now closes and an invagination of ectoderm—the stomodæum (*st.*)—takes place at the anterior end, and finally communicates with the mesenteron.

From this it will be seen that the ectoderm of the gastrula gives rise to the deric epithelium of the adult and to the epithelium of the pharynx, which is therefore a stomodæum; from the same layer the nervous system arises at a later stage. The epithelium of the intestine arises from the mesial (inwardly-turned) layers of the two endodermal folds. The muscular layer of the body-wall arises from the rest of the endoderm, *i.e.*, that portion of it which remains in immediate contact with the ectoderm. Thus in *Sagitta* the mesoderm is entirely derived from the endoderm of the gastrula.

APPENDIX TO NEMATHELMINTHES.

1. Family *Chaetosomatidæ*.

This family includes several genera of small marine worms, *Chaetosoma* (Fig. 265), *Tristichata*, *Rhabdoqaster*, and others, which are sometimes included among the Nematoda.

The body is elongated, its anterior region being sometimes dilated to form a head. Either the whole body or the dorsal surface only is beset with fine setæ, and there may be a double row of movable chitinoid hooks round the head, reminding us of the "jaws" of *Sagitta*. The ventral surface bears posteriorly curious *locomotor rods* (*f.*), either hooked or with knobbed ends: by these the animals crawl. The mouth is anterior and terminal, the anus posterior and ventral, and there is a muscular pharynx. The sexes are

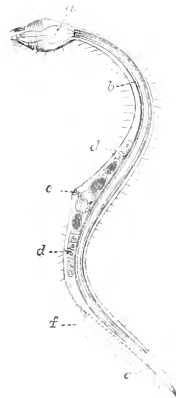

FIG. 265.—Mature female of *Chaetosoma claparedii*. : 57. *a.* esophagus; *b.* intestine; *c.* anus; *d.* *d.* ovaries; *e.* generative pore; *f.* locomotor rods. (From Shipley, after Metschnikoff.)

separate. The male has a single testis: the vas deferens opens along with the anus: there are two penial setæ. The female has paired ovaries and a single vagina opening near the middle of the body on the ventral side.

2. Family *Echinoderidae*.

Echinoderes is a minute marine worm of cylindrical form with a flattened ventral surface. The body is segmented, or divided into rings, eleven or twelve in number, all strongly cuticularised, and most of them bearing spines (Fig. 266). The mouth is placed at the anterior, the anus at the posterior end of the body: the former opens into a sac, which can be everted so as to form a proboscis or *introvert*, and is armed with spines. The enteric canal consists of a muscular pharynx and a straight intestine. A pair of sacs opening by ciliated ducts on the tenth segment appear to be excretory organs. The sexes are separate: the gonads are paired sacs opening at the posterior end of the body.

3. Family *Desmoscolecidae*.

Desmoscolex is also a minute marine worm, having a globular head and a variable number of segments (Fig. 267). The head bears four movable chitinoid rods or setæ, and a pair of similar structures occurs on many of the other segments. The terminal mouth leads by a muscular pharynx into a straight intestine: the anus is dorsal in position.

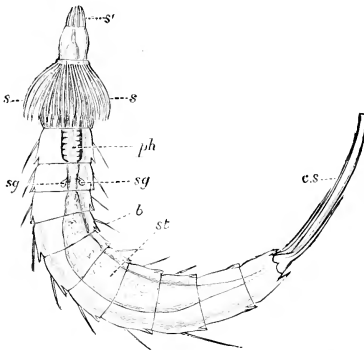

FIG. 266.—*Echinoderes*, \times about 210. *b.* spine; *c.s.* caudal spine; *ph.* pharynx; *s.* and *s'.* spines on the proboscis; *s.g.* salivary glands; *st.* stomach. (After Hartog.)

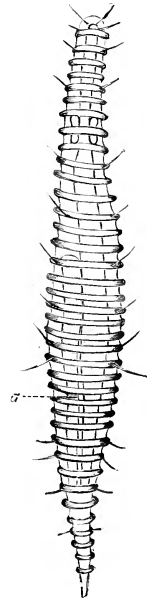

FIG. 267.—Female *Desmoscolex*, ventral view, \times 260. *a.* ovary. (From Shipley, after Panceri.)

The animal is diccious: the gonads have the form of simple sacs, the testis opening along with the anus, the ovary on the ventral surface anterior to the anus. The male has a pair of penial setæ.

Trichoderma has some superficial resemblance to *Desmoscolex*, but is nearer the ordinary Nematodes.

AFFINITIES AND MUTUAL RELATIONSHIPS OF THE NEMATHELMINTHES.

The affinities of all the classes of Nematelminthes are very obscure, and the propriety of grouping them into a single phylum is extremely doubtful. They all agree in being elongated, cylindrical worms with a body-cavity, which is sometimes of the nature of a true cœlome; there is a certain resemblance between Nematoda and Chætognatha in the muscular system; and the lemnisci of Acanthocephala have been compared with the cervical glands of Nematoda. Beyond these points there is little to unite the three classes; and, on the other hand, the proboscis of Acanthocephala recalls the rostellum of Cestoda.

Very various views have been put forward as to the affinities of the Chætognatha. But, in the absence of adequate evidence of any near relationship with higher phyla, they may be regarded as having their nearest known relatives, even if very remote, in the *Nematelminthes*. In connection with this question, the Chætosomidæ, briefly described in the Appendix (p. 313), seem to require consideration. Other possible relationships suggested by the mode of development of the cœlome from hollow diverticula of the archenteron and by other features will be referred to in later sections.

The three families placed as an Appendix to the phylum present some undoubted resemblance to the Nematoidea: this is especially the case in the reproductive organs of the Chætosomatidæ, and still more in those of Desmoscolex. But the segmentation of the body in both Desmoscolecidæ and Echinoderidæ and the presence of setæ show a certain resemblance to higher worms or Annulata, which will be more fully appreciated when that phylum has been studied.

SECTION VII

PHYLUM TROCHELMINTHES

THE typical larval form of a number of the groups which have yet to be studied is a form which is known as the *trochosphere* or, more usually, *trochophore*. It is necessary that a clear idea should be formed at this stage of this important larva, reference to which will very frequently be made in the sections that follow. The general shape of a typical trochophore is oval or pear-like (Fig. 268) with a broader and a narrower end and distinct bilateral

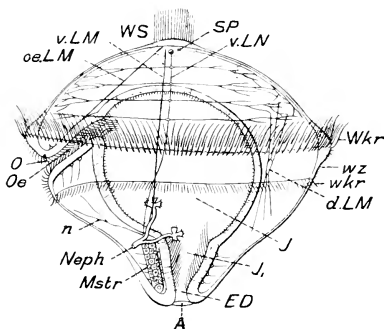

FIG. 268.—**Trochophore.** A, anus; d.LM, dorsal muscles; ED, rectum; J, stomach; J₁, intestine; Mstr, mesoderm-band; n, nerves; Neph, nephridia; O, mouth; Oe, oesophagus; α LM, oesophageal longitudinal muscle; SP, apical plate; v.LM, ventral muscle; c.LN, lateral nerve; Wkr, wkr., pre- and post-oral bands of cilia; WS, apical cilia; wz, adoral cilia. (From Hertwig's *Zoology*, after Hatschek.)

symmetry. Encircling the body about the middle, or rather nearer the broad than the narrow end, is a double cirrlet of strong cilia, the *pre-oral cirrlet* (Wkr.) or *prototroch*, situated on a corresponding ring-like thickening of the ectoderm; behind the mouth is often a second cirrlet of cilia, the *post-oral cirrlet* (wkr.), and a ciliated groove or ciliated streak usually runs backwards from it along the middle of the ventral surface. The

mouth, situated just behind the pre-oral cirrlet, leads into an alimentary canal, which at first runs nearly transversely, and then bends round so as to extend back towards the narrow end, near which it opens on the exterior by an anal aperture. About the middle of the broader (anterior) end of the trochophore is a thickening, the *apical plate* (SP.), projecting from which are usually a

number of sensory cilia (*WS.*); and in many trochophores eye-spots and a pair of short tentacles occur in close relation with the apical plate, which is the nerve centre of the larva. A pair of tubes—the excretory organs or nephridia (*Neph.*)—may be present.

In the higher groups in which this form of larva occurs, the adult condition is attained by modifications and new developments of so radical a nature that the transition from larva to adult is of the nature of a metamorphosis. Sometimes the narrow part of the larva elongates and becomes divided into a series of sections foreshadowing the metameres of the adult animal; in other cases, in which no metamerism occurs, radical changes of other kinds lead to the adult form. But in all these higher groups, whatever the nature of the changes involved, there is a metamorphosis, and the adult animal is totally unlike the larva. In a small number of forms now to be dealt with, however, there is no such radical change, and the adult may be looked upon as a somewhat modified trochophore. The groups thus associated together may not be genetically related: they may have become independently developed from trochophore-like ancestors, but the possession of the general characters which have been referred to above renders it convenient to group them together and regard them as constituting a small but well-marked phylum. The groups referred to are the *Rotifera* or Wheel-animalcules, together with the *Gastrotricha*. Associated with these, though scarcely to be included in the same phylum, are the *Dinophilea* and *Histriobdellea*.

CLASS I.—ROTIFERA.

The Rotifers or “Wheel-animalcules” are microscopic creatures, very abundant in pools, gutters, etc., and formerly classed with the Infusoria, to which several of them bear a superficial resemblance. But in spite of their minute size they are multicellular animals, having an enteric canal, a spacious body-cavity, nephridial tubes, gonads, a nervous system, and sense organs, and have therefore no real relationship with the Protozoa.

1. EXAMPLE OF THE CLASS—*Brachionus rubens*.

External Characters.—*Brachionus* (Fig. 269) is one of the commonest members of the class, being frequently found in abundance in ponds, ditches, etc. The female is about $\frac{1}{5}$ mm. ($\frac{1}{15}$ in.) in length, and is divisible into two distinct parts—a broad anterior region, the *trunk*, and a slender movable *tail* (*t.*). The trunk is enclosed in a glassy cuirass or *lorica* (*lr.*), formed by a thickening of the cuticle and produced into several spines: the tail is wrinkled superficially and ends in two slender processes, together forming a kind of forceps. One surface of the trunk is flattened and, owing to the position of the mouth, is considered as *ventral*; the

opposite or *dorsal* surface is convex both from before backwards, and from side to side.

The anterior portion of the body projects from the lorica in the form of a transverse disc (*tr. d.*) with a prominent edge fringed with cilia: this is the *trochal disc*, and is one of the most characteristic organs of the class. By the action of the cilia the animal is propelled through the water, and, as in *Vorticella*, their successive flexion gives an appearance of rotation to the disc or "wheel-organ" whence the name of the class is derived. Within the circlet

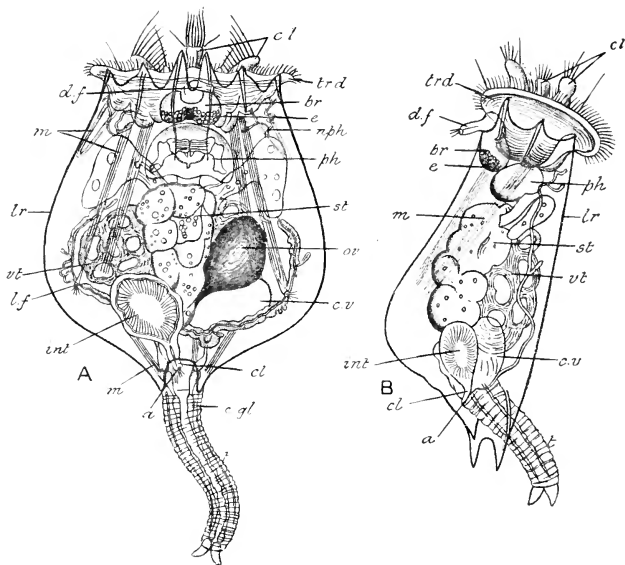

FIG. 269.—*Brachionus rubens*, female. *A*, from the dorsal aspect; *B*, from the right side. *a.* anus; *br.* brain; *d. f.* dorsal feeler; *c. gl.* cement-gland; *cl.* cloaca; *c. l.* ciliary lobes; *c. v.* contractile vesicle; *e.* eye-spot; *int.* intestine; *lr.* lorica; *l. f.* lateral feeler; *m.* muscular bands; *neph.* nephridial tubes; *ov.* germarium; *ph.* pharynx; *st.* stomach; *t.* tail; *tr. d.* trochal disc; *vt.* vitellarium. (After Hudson and Gosse.)

of cilia arise three prominences (*c.l.*) covered with cilia of large size. The trochal disc is not perfectly symmetrical, but has at one part of its circumference a depression in which the mouth lies: this marks the ventral surface. The anus (*a.*) is dorsal in position, and is placed at the junction of the tail with the trunk.

The **body-wall** consists of an epidermal layer, without cell-limits, covered by a chitinous cuticle: it is by a thickening of the latter in the region of the trunk that the lorica is produced.

There is no continuous muscular layer, but several bands of unstriped muscle (*m.*) pass from the lorica to the trochal disc in front and to the tail behind, and act as retractors of those organs.

Digestive Organs.—The *mouth* (Fig. 272, *mtl.*) lies, as already mentioned, in the ventral region of the trochal disc, anterior to the ciliary circlet but posterior to the three ciliated lobes; it leads

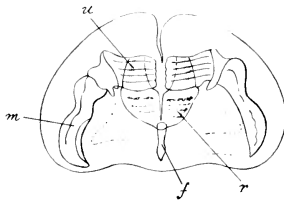

FIG. 270.—Pharynx of **Brachionus rubens**. *f.* fulcrum; *m.* manubrium; *u.* uncus; *r.* ramus. (After Hudson and Gosse.)

by a short *buccal cavity* into a *pharynx* (*ph.*) of peculiar structure known as the *mastax*, and constituting one of the most characteristic organs of the class. The mastax is a muscular chamber (Fig. 270) of rounded form, and contains, as a thickening of its cuticular lining, an elaborate apparatus for triturating the food. In the middle line is a forked structure, the *incus*, consisting of a small base or *fulcrum* (*f.*) and of two branches or *rami* (*r.*). On either side of the incus is a hammer-like structure, the *malleus*, consisting of a handle or *manubrium* (*m.*) and of a toothed head or *uncus* (*u.*). By means of the muscular walls of the chamber the heads of the mallei are worked backwards and forwards upon the forked uncus, and thus reduce the organisms taken as food to a fine state of division.

The pharynx leads by a short *gullet* into a spacious *stomach* (Fig. 272, *st.*) having a wall composed of very large epithelial cells, ciliated internally: with it are connected paired digestive glands.

The stomach opens into a rounded *intestine* (*int.*), also ciliated internally, which communicates, by means of a short *cloaca* (*cl.*) with the exterior. The stomach

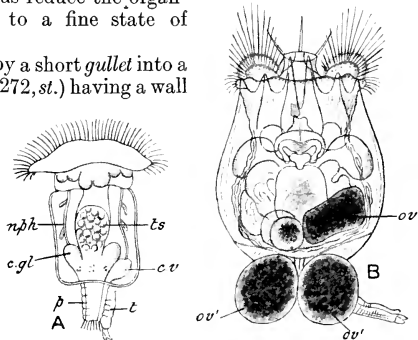

FIG. 271.—**Brachionus rubens**. *A.* male; *B.* female, with attached eggs. *c. gl.* cement-glands; *cv.* contractile vesicle; *nph.* nephridial-tube; *ov.* ovum in body; *ov^l.* ova attached to base of tail; *p.* penis; *t.* tail; *ts.* testis. (After Hudson and Gosse.)

and intestine are formed from the archenteron of the embryo and are therefore lined by endoderm: the rest of the enteric epithelium is ectodermal, the pharynx being derived from the stomodæum,

the cloaca from the proctodæum. Between the body-wall and the enteric canal is a spacious **body-cavity** containing a fluid which serves the purpose of blood and contains minute granules.

The **excretory system** consists of paired *nephridial tubes* (Figs. 269 and 272, *nph.*) resembling those of the Platyhelminthes. Their general direction is longitudinal, but they are a good deal coiled and give off little tag-like processes ending in flame-cells. Upon the end of each tag, projecting into the body-cavity, is a long flagellum. The lumen of the tubes is intra-cellular: it is uncertain whether or not the cavities of the flame-cells communicate with the body-cavity by apertures in their walls. Posteriorly the nephridial tubes open into a bladder or *contractile vesicle* (*c. v.*), the contents of which are discharged, by periodical contractions, into the cloaca.

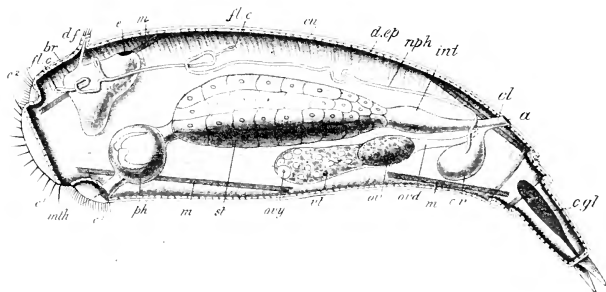

FIG. 272.—Diagram of a **Rotifer**. *a.* anus; *br.* brain; *c. l.* pre-oral, and *c. l.* post-oral cirlet of cilia; *c. gl.* cement gland; *cl.* cloaca; *c. v.* contractile vesicle; *d. ep.* dermic epithelium; *d. f.* dorsal feeler; *e.* eye; *fl. c.* flame-cells; *int.* intestine; *m.* muscles; *mth.* mouth; *nph.* nephridial tube; *ov.* ovum; *ovd.* oviduct; *ovy.* germarium; *ph.* pharynx; *st.* stomach; *vt.* vitellarium.

Nervous System and Sense Organs.—There is a single ganglion or *brain* (Figs. 269 and 272, *br.*), of proportionally large size, situated at the anterior end of the body, above (dorsal to) the mouth and pharynx. On the dorsal surface of the brain, where it comes into contact with the body-wall, is a small red *eye-spot* (*e.*). The only other organs which can be considered as sensory are three structures known as *tactile rods* or *feelers*; one of these (*d. f.*) is a small cylindrical process tipped with stiff hair-like bodies, which projects from the dorsal surface just behind the trochal disc: the other two (*l. f.*) are paired, situated on the dorsal surface of the lorica and not prominent.

The tail contains a pair of *cement glands* (*c. gl.*), by the secretion of which the animal is able temporarily to attach itself.

Reproduction and Development.—The sexes are lodged in distinct individuals, which present a striking degree of sexual

dimorphism. The preceding description applies to the female, which is the form most commonly met with. In addition to the organs already mentioned, it has a *germarium* (*ov.*, *ovy.*), connected with a large *vitellarium* (*vt.*) and opening by an oviduct into the cloaca.

The male (Fig. 271, *A*) is a very minute creature, not more than one-fourth the size of the female, and is strangely degenerate in structure. The enteric canal is absent, the trochal disc simple in structure, the nervous system and nephridial tubes greatly reduced, and the greater part of the body occupied by a large testis (*ts.*) which opens by a duct at the extremity of a protrusible, dorsally placed penis (*p.*).

After extrusion the eggs are attached to the base of the tail of the female (*B*, *ov'*), where they undergo development: they are of two sizes, the larger giving rise to females, the smaller to males. Probably both kinds develop parthenogenetically, but in the autumn thick-shelled *winter eggs* are produced which appear to require fertilisation. These remain quiescent during the winter, and in the spring develop into females.

2.—DISTINCTIVE CHARACTERS AND CLASSIFICATION.

The Rotifera are Trochelminthes of microscopic size. The anterior end is modified into a retractile trochal disc, with variously arranged cilia; the posterior end usually forms a mobile and often telescopically jointed tail. The mouth is anterior and more or less ventral in position, the pharynx contains a chitinous masticatory apparatus, and the anus is placed dorsally at the junction of the trunk with the tail. There is a spacious body-cavity devoid of epithelial lining. The excretory organs are a pair of nephridial tubes provided with flame-cells. The central nervous system consists of a single dorsal ganglion, with, in a few cases, a smaller ventral or sub-oesophageal ganglion. The sexes are separate, and the males are, in nearly all cases, smaller than the females and degenerate in structure.

The class is divided into six orders as follows:—

ORDER 1.—RHIZOTA.

Rotifera which are fixed in the adult state by the truncated end of the non-retractile tail.

Including *Floscularia*, *Stephanoceros*, *Melicerta*, etc.

ORDER 2.—BDELLOÏDA.

Rotifera which both swim freely by means of the cilia of the disc and creep after the manner of a Leech. The tail is telescopic and forked distally.

Including *Rotifer*, *Philodina*, etc.

ORDER 3.—PLOÏMA.

Rotifera in which locomotion is performed by the ciliated disc only. The tail is usually forked and more or less retractile.

Sub-order a.—Illoricata.

Ploïma in which the trunk is not covered by a lorica.
Including *Hydatina*, *Polyarthra*, *Asplanchna*, etc.

Sub-order b.—Loricata.

Ploïma in which a lorica is present.
Including *Brachionus*, *Euchlanis*, etc.

ORDER 4.—SCIIRTOPODA.

Rotifera provided with setose appendages moved by striped muscles: skipping movements are performed by the aid of these, as well as swimming movements by the trochal disc. The tail is either absent or is represented by a pair of ciliated processes.

Including *Pedalion* and *Hexarthra*.

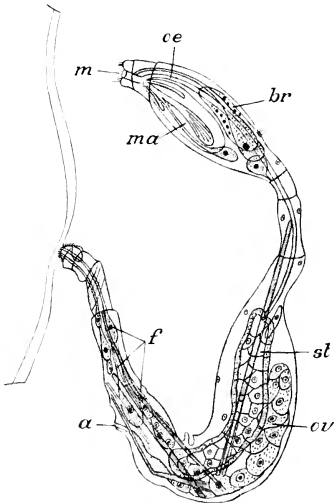

FIG. 273.—*Paraseison asplanchnus*, female, $\times 230$. *a*, genital aperture; *br*, ganglion; *f*, foot-glands; *m*, mouth; *ma*, mastax; *ce*, oesophagus; *ov*, ovary; *st*, stomach. (After Plate.)

ORDER 5.—
TROCHOSPHERIDA.

Globular Rotifera having the trochal disc represented by an equatorial circlet of cilia; tail absent.

Including *Trochosphaera* only.

ORDER 6.—SEISONIDA.

Marine parasitic Rotifers (Fig. 273), with the trochal disc reduced, the body long, narrow, and ringed, with a long slender neck-region, and an elongated foot provided at its extremity with a perforated disc.

Systematic Position of the Example.

Brachionus rubens is one of the several species of the genus *Brachionus*: it belongs to the family *Brachionidæ*, and to the sub-order *Loricata* of the order *Ploïma*.

It is placed in the order *Ploïma* in virtue of its active swimming habits and the absence of looping or skipping movements. The presence of a distinct lorica places it in the sub-order *Loricata*. The family *Brachionidæ* is distinguished by having a box-like lorica open at both ends, and a long, flexible, retractile tail with wrinkled surface and forceps-like termination. In the genus *Brachionus* the lorica is not marked with ridges, and the tail is very long and perfectly retractile. In *B. rubens* the anterior edge of the lorica is produced dorsally into six spines and is sinuous ventrally.

3. GENERAL ORGANISATION.

External Characters.—The majority of the Rotifera are free-swimming, being propelled rapidly through the water by the action of the trochal disc. But in the Bdelloida (Fig. 274, 5), in addition to this mode of progression, the animal performs looping movements like those of a leech: the tail in this order is freely jointed, the various segments fitting into one another like the tubes of a telescope, and the body is fixed alternately by it and by the anterior end, the trochal disc being kept retracted while the animal moves in this way. Many of the *Ploïma* also have a telescopic tail, but in some, e.g., *Asplanchna* (Fig. 274, 6), this organ is absent. In *Pedalion* (Fig. 275, 1) curious skipping movements are performed by the aid of six hollow limbs or appendages, one dorsal, one ventral, and two on each side. These curious organs are terminated by feathered setæ, and closely resemble the limbs of some of the lower Crustacea: each is moved by two opposing muscles which extend into its cavity (*I, B, m*). Three pairs of similar appendages are present in the other genus of Scirtopoda, *Hexarthra* (Fig. 275, 2), the resemblance of which to the *nauplius* larva of Crustacea is very striking; and four genera of unarmoured *Ploïma*, e.g. *Polyarthra* (Fig. 274, 8), possess simple or fringed setæ moved by muscles attached to their bases.

In the Rhizota the adult is permanently fixed (Fig. 274, 1-4). The end of the tail is devoid of the characteristic fork, and is attached to plants or other supports. Moreover the animal is surrounded by a tube into which it can retract itself completely, protruding the anterior end with the trochal disc when undisturbed. In most instances, as for example in *Floscularia* (1) and *Stephanoceros* (2), the tube is formed of a delicate, transparent, gelatinous secretion of the epidermis; but in *Melicerta* (3) it is built up of rounded pellets, which the animal moulds in a cup-like



1. Floscularia



2. Stephanoceros

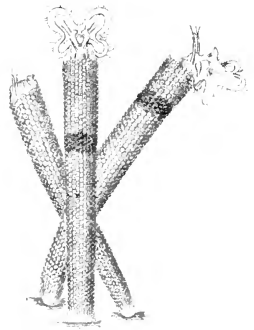

3. Melicerta

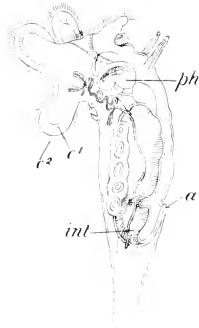

4. Melicerta



5. Philodina

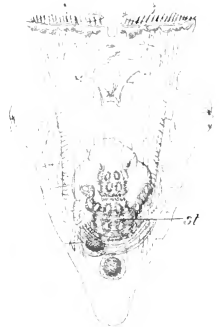

6. Asplanchna

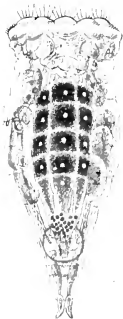

7. Hydatina



8. Polyanthra

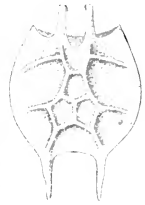

9. Noreus



10. Notholca

FIG. 274.—Typical forms of **Rotifera**:—9 and 10 show the lorica only. *a*, anus; *c*¹, *c*², ciliary cirruses; *int*, intestine; *m*, muscle; *ph*, pharynx; *st*, stomach. (After Hudson and Gosse.)

depression on the dorsal surface and places in position one by one. The pellets are usually formed of foreign particles, but in some species are made of the animal's own faeces.

The ciliation of the trochal disc is subject to considerable variation. In its simplest form the disc is surrounded by a single

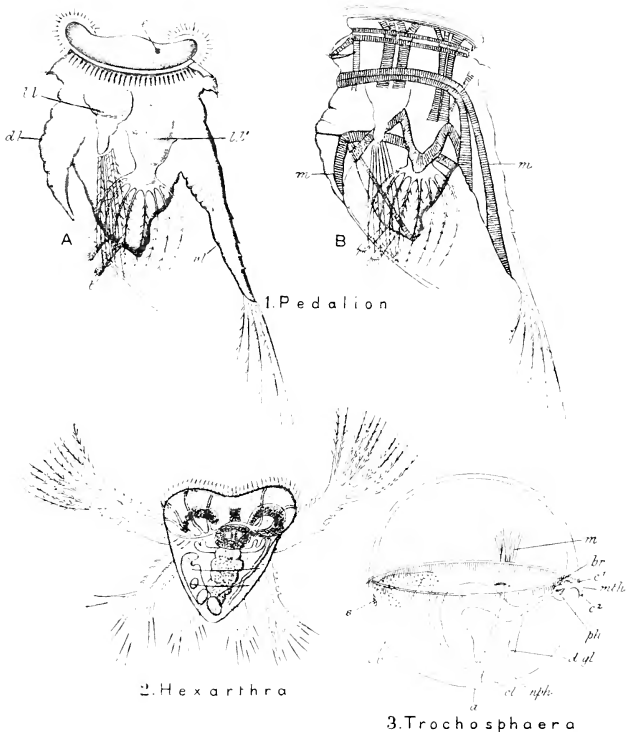

FIG. 275.—Typical forms of **Rotifera**. In 1, A shows the outer form, B the muscular system. a, anus; br, brain; c¹ c², ciliary circlets; cl, cloaca; d. gl., digestive gland; d. l., dorsal limb; e, eye-spot; l. l., l. l', lateral limbs; m, muscles; mth, mouth; nph., nephridial tube; ov., ovary; ph., pharynx; s., sense-organ; v. l., ventral limb. (After Hudson and Gosse (1 and 2) and Korschelt and Heider (3).)

cirlet of cilia, within which lies the mouth. A modification of this type may be produced by the prolongation of the ciliary crown into long arm-like processes fringed with cilia, as in *Stephanoceros* (2), or, as in *Floscularia* (1), into blunt elevations

bearing long stiff cilia like the pseudopodia of the Heliozoa. The single cirlet may be folded upon itself, or a second type may be produced by the addition of a second cirlet within and parallel to the first. The mouth in this case is always placed between the two cirlets on the ventral side (Fig. 272), so that the inner or anterior cirlet is pre-oral and corresponds with the chief ciliary band of a trochophore larva, while the outer or posterior cirlet corresponds with the post-oral band found in many worm-larvæ. In the curious globular *Trochosphæra* (Fig. 275, 3) there is a single equatorial cirlet, which is pre-oral, and a few post-oral cilia: here the correspondence with the typical worm-larva is singularly close. Lastly, both the pre- and post-oral cirlets may be produced into more or less complex lobes, as in *Melicerta* (Fig. 274, 4), or may be interrupted as in *Brachionus*, in which the pre-oral cirlet is represented by three distinct lobes, or as in *Pedalion*, in which both cirlets are divided into right and left moieties. In one genus the trochal disc is absent.

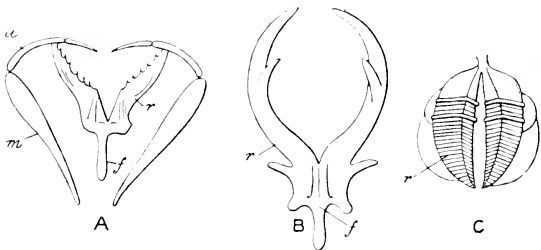

FIG. 276.—Typical forms of mastax. *A*, forcipate type; *B*, incudate type; *C*, ramate type: *f.* fulcrum; *m.* manubrium; *r.* ramus; *u.* uncus. (After Hudson and Gosse.)

Digestive Organs.—The typical form of mastax or pharyngeal mill is that described in *Brachionus* (Fig. 270). There is an unpaired *incus* consisting of a short stem or *fulcrum* (*f.*) and of two broad branches or *rami* (*r.*), and a pair of *mallei*, each consisting of a stout handle or *manubrium* (*m.*) and a broad, toothed head or *uncus* (*u.*). In some forms all the parts of the apparatus become very slender, the incus assuming the form of forceps (Fig. 276, *A*). Or the mallei may be absent and the two rami movable upon one another so as to convert the incus into a pair of forceps (*B*) used to seize prey, the mastax being in this case protrusible. Lastly, the fulcrum and manubrium may be absent, and the unci and rami very strong and massive (*C*). Glands, supposed to be salivary, open into the mastax or œsophagus.

The *stomach* is always large, and usually has a pair of digestive glands opening into it: it may pass insensibly into the intestine,

or the latter may be a distinct chamber of more or less globular form. In the Rhizota the intestine turns forwards so as to allow of the anus being brought over the edge of the tube in defæcation (Fig. 274, 4, a). In *Asplanchna* (6) the stomach ends blindly, the intestine, cloaca, and anus being absent.

The **excretory system** is very uniform in structure. It consists of a pair of more or less coiled nephridial tubes, placed longitudinally and giving off lateral branchlets which end in *flame-cells*. The outer surface of each flame-cell usually bears one or sometimes two flagella, which lie free in the body-cavity. Frequently, but not always, the two tubes open posteriorly into a contractile vesicle or bladder which discharges into the cloaca.

Nervous System and Sense-Organs.—The nervous system usually consists of a single ganglion (Fig. 272, br.) towards the dorsal aspect of the anterior part of the body, and representing the brain or supra-œsophageal ganglion of the higher Worms: it sends nerves to the muscles, trochal disc, and tactile organs. In some cases a smaller ventral or infra-œsophageal ganglion is present as well, connected with the first by a pair of slender œsophageal connectives. Connected with the dorsal ganglion are a pair of lateral longitudinal nerves which run backwards to the tail, giving off branches in their course. One or more *eyes* (e.) are usually present in close relation with the brain, and are sometimes mere spots of pigment, but may be provided with a refractive body or lens. The only other organs of sense are the *tactile rods* (d.f., l.f.), of which there is usually one on the dorsal surface near the anterior end of the body, and frequently two others, one on each side of the trunk. They are more or less rod-like structures, tipped with delicate sensory hairs and receiving nerves from the brain.

Reproduction and Development.—In most cases the female reproductive organs have the same general character as in Brachionus, *i.e.* the gonad is unpaired (Fig. 269), consists of germarium and vitellarium, and is provided with an oviduct (Fig. 272). But in some of the Bdelloida, such as *Philodina*, there are two ovaries, not divisible into germ-gland and yolk-gland, and the oviduct is absent. The males are smaller than the females and degenerate in structure, the enteric canal being atrophied (Fig. 271, A). There is a large testis (t.) with a duct opening at the end of a protrusible penis (p.), which is dorsal in all but *Asplanchna*, in which it, as well as the cloacal opening of the female, appears to be ventral. Apparently *hypodermic impregnation* sometimes takes place, *i.e.* the body-wall of the female may be perforated at any place for the entrance of the sperms.

Three kinds of eggs are produced: large and small *summer eggs*, which always develop parthenogenetically, the larger giving rise to females, the smaller to males; and thick-shelled *winter eggs*, which

probably require impregnation, and remain in an inert condition all through the winter, finally developing in the spring. Most Rotifers are oviparous, but some (*Philodina*, etc.) bring forth living young, which are born by breaking through the body-wall or through the cloaca, thus causing the death of the parent.

Segmentation is total and irregular, the oosperm dividing into megameres and micromeres. An epibolic gastrula is formed, the blastopore closes, and invaginations of ectoderm give rise to the stomodæum and proctodæum. The tail is formed as a prolongation of the postero-ventral region of the embryo, and contains at first an extension of the endoderm. No metamorphosis is known to take place in any member of the class.

Ethology.—A few Rotifers live in the sea, but the majority are fresh-water forms, occurring in lakes, streams, ponds, and even in puddles the water of which is rendered foul and opaque by mud and sewage. Frequently the water in which they live is dried up, and the thick-shelled winter eggs may then be widely dispersed by wind. It is even stated that the adult animals may survive prolonged desiccation and resume active life when again placed in water. They are able to survive prolonged exposure to temperatures far below the freezing point of water. Many forms cling to the bodies of higher animals in order to obtain a share of their food, thus leading a kind of commensal existence. Others go a step further and become true external parasites, like *Drilophaga* on a fresh-water Oligochæte (*vide* Section X), or *Seison* on the little Crustacean *Nebalia*. Others, again, are internal parasites, such as *Albertia* in the cœlome of Earthworms and the intestine of fresh-water Oligochætes (*Nais*), and *Notommata werneckii* in the cells of the fresh-water Alga *Vaucheria*.

Affinities.—The affinities of the Rotifera are very obscure. Their general resemblance to the free-swimming larvæ of Annelids (phylum *Annulata*) is extremely close, and, in particular, the curious *Trochosphæra* is, to all intents and purposes, a sexually mature trochophore with a mastax. The excretory organs recall those of the Platyhelminthes, and also resemble the provisional nephridia or head-kidneys of Annulate larvæ. Lastly, the hollow muscular appendages of Pedalion and Hexarthra give those genera a certain resemblance—which is probably, however, merely adaptive—to the nauplius or free-swimming larva of Crustacea.

Class II.—GASTROTRICHA.

The *Gastrotricha* (Figs. 277 and 278) are a small group of minute fresh-water animals, which are apparently allied, though certainly not very closely, to the *Rotifera*, and are on that account placed in the present phylum. The body is spindle-shaped with flattened ventral surface. The ventral surface bears two longitudinal bands of cilia; the dorsal is non-ciliated, but in some forms bears a number of longitudinal rows of slender, pointed, cuticular processes. The aboral end is narrow and usually bifurcated.

On the head are four tufts of flagella, which are partly sensory, partly vibratile. The mouth, situated at the anterior end, leads by a narrow tube into the thick-walled œsophagus. At the beginning of the latter are a number of small chitinous denticles, and in front of them a circlet of setæ. The œsophagus leads to a wide elongated stomach followed by a short intestine which terminates in an anal aperture at the posterior extremity. The

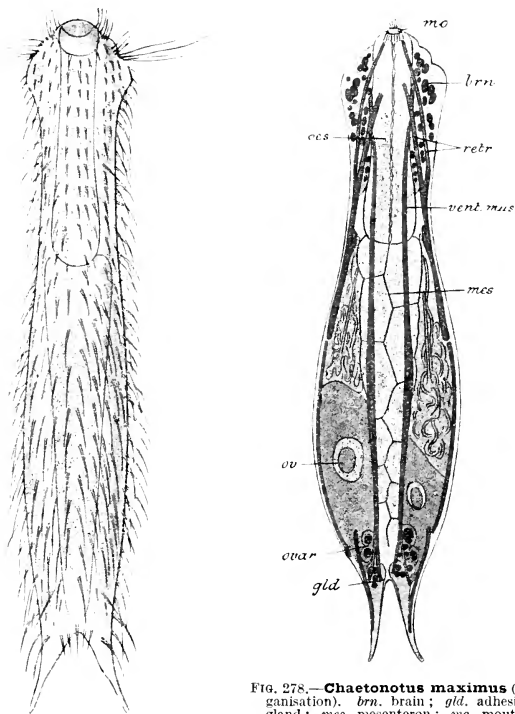

FIG. 277.—*Chaetonotus maximus*.
Highly magnified. (After Zelinka.)

FIG. 278.—*Chaetonotus maximus* (organisation). *brn*, brain; *gld*, adhesive gland; *mes*, mesenteron; *mo*, mouth; *œs*, œsophagus; *ov*, ovum; *ovar*, ovary; *retr*, retractor muscles; *vent. mus*, ventral muscle. (After Zelinka.)

nephridia are a pair of unbranched coiled tubes each opening on the ventral surface and terminating internally in a flame-cell. The nervous system consists of a large dorsally and anteriorly situated cerebral ganglion or brain giving off a pair of ventro-lateral longitudinal nerves. The sexes are united, and there is no metamorphosis.

APPENDIX TO THE TROCHELMINTHES.

The *Dinophilea* and *Histriobdellea*.

These are two isolated groups of minute animals which may most conveniently be dealt with in association with the Trochelminthes, since they bear certain striking resemblances, now to one, now to another, member of that phylum; but they differ from all of them in the assumption of a simple kind of metamerism (p. 43), by virtue of which they have claims to association with the Annulata—a phylum to be treated of later. The *Dinophilea* are free-living animals, mostly marine, one species living in brackish water.

The *Histriobdellea* are parasitic or commensal, and live on the European lobster and the Australian fresh-water crayfishes.

Dinophilus (Fig. 279) is a minute worm-like marine animal with a head or prostomium, a body composed of from five to eight segments separated from one another by constrictions, and a short ventral tail. The prostomium bears two eye-spots and some sensory hairs: it is either covered uniformly with cilia, or bears two or three annular ciliated bands apparently representing the prototroch of the trochophore. The body is in some of the species uniformly ciliated; in others the cilia are disposed in rings corresponding to the segments, except on the ventral surface, where the ciliation is always uniform. The mouth, which is situated on the ventral aspect of the prostomium, leads

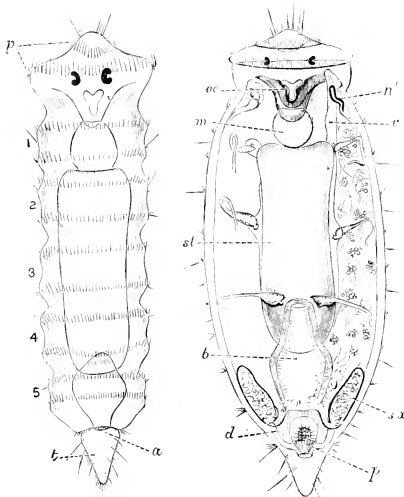

FIG. 279.—*Dinophilus taeniatus*. The left figure represents the dorsal surface of a young individual, $\times 76$; the mouth and alimentary tract are seen by transparency. The right figure shows the anatomy of the male, $\times 38$. *a.* anus; *b.* rectum; *c.* body-cavity; *d.* vas deferens; *m.* pharynx; *n'.* the first nephridium; *æ.* entrance to the œsophagus; *p.*, in left fig., prostomium; *p.*, in right fig., penis; *st.* stomach; *s.* *x.* vesicula seminalis. (From Shelton, after Harmer.)

into an alimentary canal consisting of œsophagus, stomach, and intestine, all of which are ciliated; the anus (*an*) is placed dorsally over the tail. A protrusible muscular proboscis lies, when retracted, in a recess opening close to the mouth. There is an imperfectly developed cœlome (hæmocœle?) which is crossed by strands of connective-tissue, and a ventral blood-vessel. A nervous system is present, and consists of a large dorsal ganglion in the prostomium, giving off two anterior and two posterior nerves or ventral cords (sometimes segmented into a series of ganglia connected in each segment by commissures), all situated in the epidermis.

The excretory system consists of a series of metamericly arranged pairs of tubes (*n'.*). The inner ends of these do not open into the body-cavity, but

are provided with peculiarly modified flagellate cells known as *solenocytes*, so that these paired excretory tubes resemble closely the nephridia of some of the Polychæta (phylum Annulata; see Section X). The sexes are separate. In the male there is a conical ventral penis; the last pair of nephridia act as vesiculæ seminales. In the ovary two sets of ova are developed, the larger destined to give rise to females, and the smaller destined to form males. They pass into the body-cavity and reach the exterior by an aperture on the ventral surface in front of the anus.

A process of unequal segmentation is followed by the formation of an epibolic gastrula. What is known of the development is in favour of the view that *Dinophilus* is to be looked upon as a trochophore-like form that has made some progress in the evolution of metamerism.

The *Histriobdellea* comprise only the two nearly-allied genera *Histriobdella* and *Stratiodrillus* (Fig. 280)—the former found in the gill-cavities and on the eggs of the European lobster and the Norway lobster, the latter in the gill-cavities of Australian and Tasmanian fresh-water crayfishes. The animal is narrow, almost cylindrical, with a well-marked head, a body of six segments, and a narrower tail-region in which segmentation is not clearly marked. The head bears five tentacles (t^1 , t^2 , t^3) tipped with non-motile sensory cilia, and a pair of appendages or limbs (*l.a.*) (retractile in *Stratiodrillus*), with basal glands the ducts of which open at their extremities. The head has the mouth at or near its anterior extremity on the ventral aspect. The body bears, in *Stratiodrillus*, three pairs of two-jointed non-retractile appendages or cirri (c^1 , c^2 , c^3) tipped with non-motile cilia, and in the male a pair of retractile appendages or claspers (*cl.*). At the end of the tail is a pair of large freely movable appendages or legs (*l.p.*), which are the chief organs of locomotion; at the end of each of these open the ducts of a mass of unicellular glands. The anus is situated posteriorly between the bases of the legs. Opening from the mouth-cavity on its ventral aspect is a muscular sac in which are enclosed, when retracted, a system of chitinous jaws reducible to the same general type as the mastax of the Rotifera, but with the relative position of malleus and incus inverted. There is a highly developed nervous system consisting of a large brain (*br.c.*) situated dorsally in the prostomium, a pair of œsophageal connectives, and a ventral nerve cord (*n.c.*) with a series of ganglia which have a distinctly metameric arrangement. The excretory

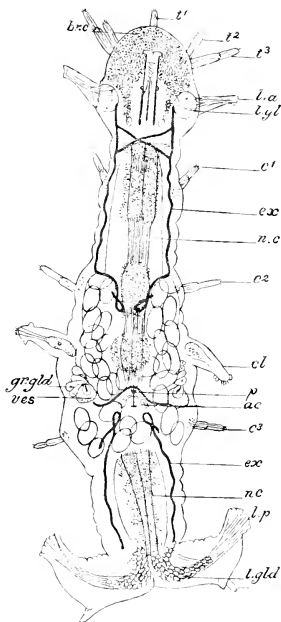

FIG. 280.—*Stratiodrillus tasmanicus*, male. *ac.* accessory gland of male apparatus; *br. c.* brain; *c¹, c², c³*, cirri; *cl.* claspers (appendages peculiar to the male); *ex.* excretory tubes; *gr. gland.* granule-gland; *l. a.* anterior limb; *l. gl.* gland at base of anterior limb; *l. gland.* gland at base of posterior limb; *l. p.* posterior limb; *n. c.* nerve-cord; *p.* penis; *t¹, t², t³*, tentacles; *ves.* vesicula seminalis.

system takes the form of ciliated tubes (*ex.*), closed internally, and showing a tendency to metamerism: these in *Stratiodrillus* extend into the head. The sexes are distinct: the male has a protrusible penis, directed ventrally. There is no metamorphosis.

There seems to be some reason for believing that *Dinophilus* and the *Histriobdellea* may help to bridge over the interval between the Trochelminthes and the higher, segmented, worms or Annulata. In this connection the Echinoderidæ, which were noticed in an appendix to the last Section (p. 313), have also to be kept in view.

SECTION VIII

PHYLUM MOLLUSCOIDA¹

THE phylum Molluscoida comprises three classes—the *Polyzoa* (including, provisionally, the *Endoprocta*), the *Brachiopoda*, and the *Phoronida*. The members of these three classes are tolerably widely divergent, so that it is somewhat difficult to frame a general account of the entire phylum; but the following are the most important common features:—

There is, except in the *Endoprocta*, a body-cavity (cœlome), lined in most cases with a cœlomic epithelium, within which the alimentary canal is suspended by means of mesenteries or by means of funicular strands taking their place. The dorsal region of the body is abbreviated, being represented only by a short space between the mouth and anus, which are closely approximated. There is a *lophophore* or tentacle-bearing ridge, usually of a horse-shoe shape, containing a special compartment of the cœlome, and overhanging the mouth on its anal side there is in most cases a sensitive process—the *epistome*—also containing a special compartment of the body-cavity. The central part of the nervous system consists of a single ganglion (supra-œsophageal), or of two ganglia (supra-œsophageal and infra-œsophageal), or of a nerve-ring. The nephridia when present are in nearly all cases a single pair of ciliated tubes, which act also as gonoducts.

CLASS I.—POLYZOA.

The Polyzoa form colonies known as “Sea-mats,” or “Coral-lines,” which in many cases bear a close general resemblance to Hydroid Zoophytes, and only on a more minute inspection are found to differ totally from the latter and to exhibit a very much higher type of structure.

¹ This and all the remaining phyla of the animal kingdom are characterised by the possession of a true *cœlome*, *i.e.* of a cavity interposed between the wall of the body and that of the enteron, and developed either directly by outgrowth from the archenteron, or formed from clefts that appear in solid masses of mesoderm cells. The only group hitherto dealt with in which a definite cœlome is present is the Chætognatha. In some of the groups which are here comprised in the cœlomate phyla, however, as will be seen, the cœlome is reduced, or entirely absent, or not typically developed.

I. EXAMPLE OF THE CLASS—*Bugula avicularia*.

Bugula avicularia, the common Bird's-Head Coralline (Fig. 281), occurs in brown or purple bushy tufts, two or three inches long, on rocks, piles of jetties, and similar situations on the sea-shore in all parts of the world. On a naked-eye examination it presents a considerable resemblance to a Hydroid Zoophyte, and might readily be taken for a member of that group. It consists of dichotomously branching narrow stems, which are rooted by a number of slender root-filaments. Each stem is found, when examined with a lens, to be made up of a number of elements, the *zoecia* of the colony, which are closely united together and arranged in four longitudinal rows. The zoecia are approximately cylindrical in shape, but broader distally than proximally, four or five times as long as broad, and have, near the distal end, a wide crescentic aperture—the “mouth” of the zoecium—on either side of which is a short blunt spine. A rounded structure—the *oecium*—in many parts of the colony lies in front of each zoecium (Fig. 281, *oec.*). On each zoecium, except a few at the extremities of the branches, is a remarkable appendage, the *avicularium* (*avic.*), having very much the appearance of a bird's head supported on a very short stalk: if the *Bugula* is examined under the microscope in the living condition, the avicularia will be found to be in almost constant movement, turning from side to side; and a movable part, comparable to the lower jaw of the bird's head, will often be seen to be moved in such a way that the mouth of the avicularium is opened very widely and then becomes closed up with a quick “snap.” All the parts hitherto mentioned can be shown, by using appropriate tests, to be composed of some material akin to chitin in composition. The chitinous wall of the zoecia is the hardened and thickened cuticle of the zooids, having beneath it the soft body-wall.¹ The anterior region of the body of the zooid forms an *introvert*, *i.e.* is capable of being involuted like the finger of a glove within the more posterior part: the cuticle covering this, continuous behind with the thick ectocyst, is quite thin and flexible. When the introvert is everted it is seen to bear at its anterior end a circlet of usually fourteen long, slender filiform tentacles (*tent.*) on a circular ridge or *lophophore* surrounding the mouth of the zooid. The tentacles are densely ciliated except along their outer surfaces: the cilia vibrate actively in such a way as to drive currents of water, and with them food-particles, towards the mouth (*mo.*): they are also capable of being bent in various directions. In the interior of each is a narrow prolongation of the coelome. In all probability, besides bringing minute particles of food to the mouth of the zooid by the action of their cilia, the tentacles are prehensile as well as

¹ The terms *ectocyst* and *endocyst* are commonly applied respectively to the hardened cuticle of the zooid and its soft body-wall.

tactile, and also act as organs of respiration. When retracted they become enclosed by the walls of the introvert as by a sheath—

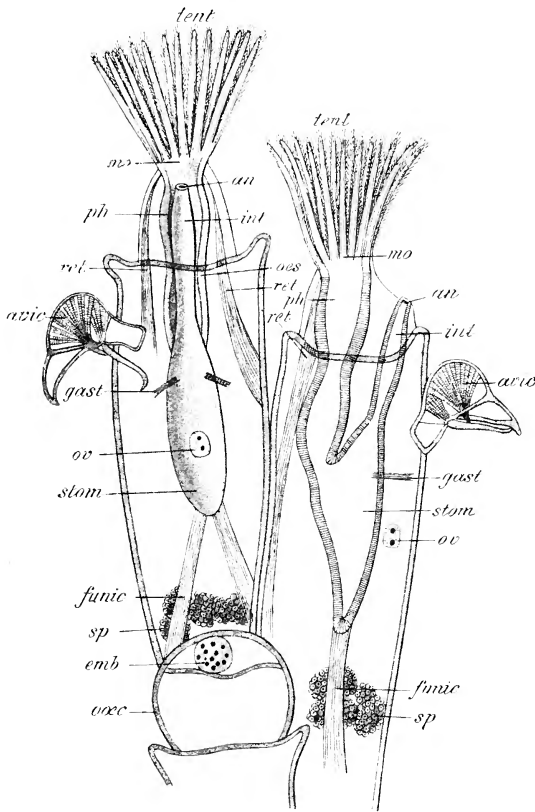

FIG. 281.—*Bugula avicularia*. Two zooids, magnified. *an*, anus; *avic*, avicularia; *emb*, embryo enclosed in the oecium; *funic*, funiculus; *gast*, muscular bands passing from the stomach to the body-wall; *int*, intestine; *mo*, mouth; *oec*, oecium; *oes*, oesophagus; *ov*, ovary; *ph*, pharynx; *ret*, parieto-vaginal muscles; *sp*, spermatidia; *stom*, stomach; *tent*, tentacles. The ganglion, which is not indicated, lies just below the middle of the stroke from *mo*.

the *tentacle-sheath*. A pair of bands of muscular fibres—the *parieto-vaginal* muscles (*ret.*)—passing to the introvert from the body-wall, serve to retract the introvert and tentacles.

The **body-wall** consists, in addition to the cuticle, of an epidermis composed of a single layer of large flattened cells, two muscular layers, the outer circular and the inner longitudinal, and a layer of an irregular cellular tissue, or parenchyma.

The **cœlome** is extensive; it is lined externally by the parietal layer of parenchyma forming the innermost layer of the body-wall, and internally by a visceral layer of the same tissue, ensheathing the alimentary canal. Across the cavity between the parietal and visceral layers of the parenchyma pass numerous strands of spindle-shaped cells. A large double strand (*funic.*) passes from the proximal or aboral end of the alimentary canal to the aboral wall of the zœcium; this is the *funiculus*. A transverse partition cuts off (though not completely) a small anterior compartment of the cœlome from the rest. The former surrounds the bases of the tentacles, the narrow internal cavities of which are in communication with it: this is known as the *circular canal*. The cœlomic fluid contains a number of colourless corpuscles or leucocytes.

Alimentary Canal.—The mouth (*mo.*) leads into a wide chamber—the *pharynx* (*ph.*)—just behind the bases of the tentacles; from this a somewhat narrower short tube, separated by a constriction from the pharynx, leads to the *stomach* (*stom.*) from which it is also separated by a constriction. The stomach gives off a long conical prolongation or *cæcum* passing towards the aboral end of the zœcium, to which it is attached by the funiculus. The *intestine* (*int*) comes off from the oral aspect of the stomach, not far from the œsophagus, with which it lies nearly parallel: it terminates in a rounded anal aperture (*an.*) capable of being distended to a considerable size, situated not far from the mouth, but outside the lophophore. The entire alimentary canal is lined by an epithelium, which is ciliated throughout except in a portion of the stomach: the cells of the epithelium, which are arranged in a single layer, vary in length in different regions, being longest in the pharynx, which is comparatively thick-walled. A pair of slender muscles (*gast.*) passing from the body-wall to the stomach act as *retractors* of the alimentary canal when the introvert is drawn back.

There are no blood-vessels.

The **nervous system** consists of a small round ganglion situated between the mouth and the anus, giving off nerves to the various parts; organs of special sense are absent. Definite **excretory organs** do not occur in Bugula, the function of excretion (*i.e.* the collection of the nitrogenous waste-matters) being apparently carried on by the leucocytes and the cells of the funicular tissue.

Reproductive Organs.—Ovary and testis are found to occur together in the same zooid. They are both formed from specially

modified cells of the parenchyma, either of the funiculus or of the body-wall. The testis, developed from the cells of the funicular tissue, gives origin to spherical masses of cells—the *spermatidia* (*sp*)—which develop into sperms with very long motile tails. These become free from one another and move about in the body-cavity or in its prolongations into the tentacles. There is no spermiduct, and it is doubtful if the sperms pass to the exterior. The ovary (*ov*) is a small rounded body formed from the parietal layer of the parenchyma about the middle of the zoëcium; it consists of only a small number of cells of which only one at a time becomes a

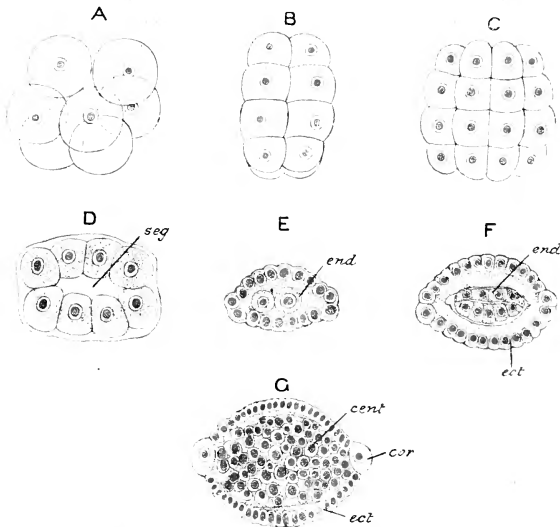

FIG. 282.—Early stages in the development of *Bugula*. *cent.* central mass of cells; *cor.* corona; *ect.* ectoderm; *end.* endoderm; *seg.* segmentation-cavity. (After Vigelius.)

mature ovum, certain smaller cells forming an enclosing follicle. The mature ovum is perhaps fertilised in the cœlome; it passes into the interior of a rounded outgrowth of the zoëcium—the *oœcium* (*oœc.*)—lined with parenchyma, and forming a sort of brood-pouch in which it undergoes development.

Development.—Segmentation (Fig. 282) is complete and nearly regular. A blastula is formed having the shape of a bi-convex lens. In the interior of the blastocœle or cavity of the blastula, four cells (*end.*)—the primitive endoderm cells—become distinguishable; these increase in number by division, and form a mass of free cells which almost completely

fill the blastocœle; this mass apparently represents both endoderm and mesoderm. Small cavities which appear in it subsequently unite together to form the primitive cœlome. A very broad ring-shaped thickening—the *corona* (*G*, *cor.*)—is formed round the equator of the embryo and becomes provided with cilia. A circular *pallial groove* arises on the oral side of the corona. A sac-like, afterwards beaker-shaped invagination of the ectoderm on what is destined to become the oral side of the ciliated ridge, forms a larval structure, termed the *sucker* (Fig. 283, *suck*), which afterwards serves to fix the larva. A second depression of the ectoderm in the region of the corona on the oral side forms the *ectodermal groove*. At the aboral pole is developed, also from the ectoderm, a second larval structure—the *calotte* or *retractile disc* (*disc*), on which motionless sensory cilia

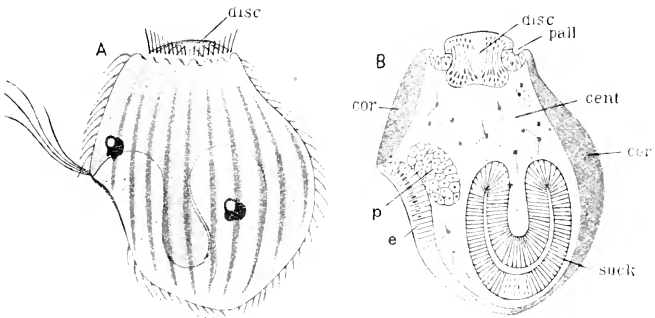

FIG. 283.—A, Larva of *Bugula plumosa*; B, Sagittal-section of larva of *Bugula* (diagrammatic). *cent.* central tissue; *cor.* corona; *disc.* retractile disc; *e.* ectodermal groove; *p.* pyriform organ; *pall.* pallial groove; *suck.* sucker. (From Korschelt and Heider, after Barrois.)

appear. In close relation to the ectodermal groove is formed a mass of cells, the *pyriform organ* (*p.*) which seems to have a sensory function.

An alimentary canal is absent in the larva of *Bugula* when it escapes from the oœcium. After an interval of free existence as a ciliated larva, certain changes appear which lead to a very complete metamorphosis. The sucker becomes everted by a strong contraction of the body, and fixes the larva to some foreign object. The aboral side of the larva becomes greatly extended, so that almost the entire integument of the primary zooid is developed from this part (*i.e.* from the region occupied by the retractile disc and pallial groove). Accompanying the extension of the aboral surface are the obliteration of the pallial groove and the bending down of the corona towards the oral side. Thus the stage

of the larva termed the *umbrella-shaped* stage is reached. The sucker is everted, and by means of it the larva becomes attached. The edge of the "umbrella" becomes bent downwards, and fused with the broad plate into which the sucker has expanded, thus enclosing a circular cavity, the so-called *vestibule* (Fig. 284, *v.*). The walls of this, consisting of the coronal cells and a portion of the original sucker, become broken up and the cavity is merged in the general cavity in the interior of the larva. All the larval structures have now disappeared with the exception of the basal plate of the sucker and the retractile disc. The former gives rise to the basal part of the wall of the primary zoecium. From the latter, which becomes invaginated, or from a sac which is developed to replace it, are developed both the ectodermal and endodermal structures of the primary zooid. Occupying the interior of the larva at this stage in addition to this sac, there is only a mass of undifferentiated tissue derived from the original central tissue together with that derived from the disintegrated corona, pyriform organ, and part of the sucker. The outer wall forms the wall of the primary zoecium, the surface of which becomes covered with a chitinous cuticle or ectocyst. Most of the internal mass goes to form a *brown body*, which now becomes developed, but a part of it seems to form the mesoderm of the zooid. A diverticulum of the sac constitutes the first rudiment of stomach and intestine; a second diverticulum forms the rudiment of the oesophagus; these become applied to one another and fuse to form the continuous alimentary canal. The ganglion arises as an invagination of the ectoderm in the space between mouth and anus. The upper part of the cavity of the primitive sac, after the rudiment of the alimentary canal has been separated off, forms a space termed the *atrium*; the walls of this become converted into the tentacle sheath, while on its base appear the rudiments of the tentacles and lophophore. During the development of the organs of the adult zooid the brown body becomes closely applied to the stomach and gradually absorbed.

The primary zooid thus formed gives rise asexually by a process of repeated budding to the branching structure which has been described. In many of the zoecia of a fully-developed colony no zooid is found to be present, but, instead, there is a dark brown body similar to that which occurs in the primary zoecium. This is a zooid that has undergone degeneration—the lophophore

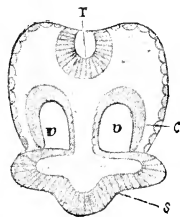

FIG. 284.—Longitudinal section of attached larva of *Bugula*. *c.* cells of corona; *r.* rudiment of the zooid in the form of a sac; *s.* basal plate of everted sucker; *v.* vestibule. (From Korschelt and Heider, after Barrois.)

tentacles, and alimentary canal having been absorbed. Such degenerated zooids are capable of regeneration, the organs becoming re-developed and the brown body re-absorbed.

2. DISTINCTIVE CHARACTERS AND CLASSIFICATION.

The Polyzoa are Molluscoidea which, with one exception, form colonies of zooids connected together by a common organic substance. There is a lophophore bearing a series of slender, ciliated, post-oral tentacles. The anterior part of the body forms, in the majority, a short introvert, within which the lophophore and the tentacles are capable of being withdrawn. In some the prostomium is represented by a small lobe—the epistome. The alimentary canal is U-shaped, and the anus is anterior, within, or just outside, the tentacular circlet. In most the nervous system is represented only by a small ganglion between the mouth and the anus. A cuticle, sometimes gelatinous, sometimes horny, sometimes calcified, forms a firm exoskeletal layer for the support of the colony. Nephridia (corresponding to the head-nephridia of the trochophore) occur only in the *Endoprocta*. There is no vascular system. The sexes are usually united. The majority of Polyzoa occur in the sea; a limited number are inhabitants of fresh water.

Sub-Class I.—Ectoprocta.

Colonial Polyzoa with the anus outside the lophophore, with a well-developed introvert and a spacious cœlome.

ORDER 1.—GYMNOLÆMATA.

Almost exclusively marine Ectoprocta, with a circular lophophore, and without an epistome.

Sub-order a.—Cyclostomata.

Gymnolæmata with tubular calcareous zoecia having circular apertures devoid of closing apparatus.

Including *Crisia*, *Idmonca*, &c.

Sub-order b.—Cheilostomata.

Gymnolæmata with calcareous or chitinous zoecia usually provided with opercula.

Including *Bugula*, *Flustra* ("Sea-mat"), *Membranipora*, *Cellepora*, *Selenaria*.

Sub-order c.—Ctenostomata.

Gymnolæmata with chitinous or gelatinous zoecia provided with a series of tooth-like processes closing the aperture when the tentacles are retracted.

Including *Alcyonidium*, *Serialaria*, *Paludicella*.

ORDER 2.—PHYLACTOLÆMATA.

Fresh-water Ectoprocta with horse-shoe-shaped lophophore and with an epistome.

Including *Cristatella*, *Plumatella*, *Fredericella*.

Sub-Class II.—Endoprocta.

Colonial or solitary Polyzoa multiplying by the formation of buds, which in *Lozosoma* soon become separated off, while in *Pedicellina* they remain connected together by a creeping stolon. The anus, as well as the mouth, is internal to the lophophore. The introvert is slightly or not at all developed. A pair of ciliated nephridial tubes are present.

Systematic Position of the Example.

Bugula avicularia is an example of the sub-order Cheilostomata of the Gymnolæmata. It is a member of the family Bicellariidæ, which is characterised by the erect plant-like colony, with narrow compressed branches, and attached by root-like fibres; by the avicularia, when present, being stalked and bird's-head shaped; and by the wide oblique apertures of the zoœcia all facing in the same direction. *Bugula* differs from the other genera of the family in the arrangement of the zoœcia in double or multiple rows, in their close union, and in the avicularia, when present, being on the side on which the mouth is situated. The various species differ in the exact shape of the zoœcia and of the avicularia.

3. GENERAL ORGANISATION.

Sub-Class I.—Ectoprocta.

The Ectoprocta and the Endoprocta differ so considerably from one another that it is advantageous to deal with them separately. The Ectoprocta are all colonial—the colonies being capable, in most cases, like the colonies of hydroid zoophytes, of increasing in size to an apparently indefinite extent by continuous budding. The thickened cuticle which forms the support of the colony is sometimes gelatinous, sometimes chitinous, sometimes chitinous with sand-grains affixed, sometimes calcareous. The form of the colony varies in different families and genera in accordance with differences in the shape of the constituent zoœcia, and differences in their mode of budding and consequent arrangement. The zoœcia are sometimes tubular, sometimes ovoid, sometimes polyhedral. In some cases the buds are so developed that the colony assumes the form of a thin, flat expansion, which may be encrusting, and consist of a single layer of zoœcia in close contact with one another or connected together by tubular processes; or may be erect, and with the zoœcia either in one or two layers: sometimes

the lamellar colony thus formed may be fenestrated or divided into lobes; sometimes it is twisted into a spiral. In other cases the colony, instead of being lamellar, has the form of an erect, shrub-like structure, consisting of numerous cylindrical, many-sided, or strap-shaped branches arising from a common root. Sometimes there is a creeping cylindrical stolon, simple or branched, having the zooids arranged along it in a single or double row. The colony is free only in *Cristatella* (Fig. 286)—in which it performs creeping movements, in some other (American) forms of Phylactolæmata (in the younger stages of the colony), in one family of the Cheilostomata—the *Selenariidæ* (in which it moves along with the aid of certain peculiar appendages—the *vibracula*—to be described subsequently), and in one or two other cases.

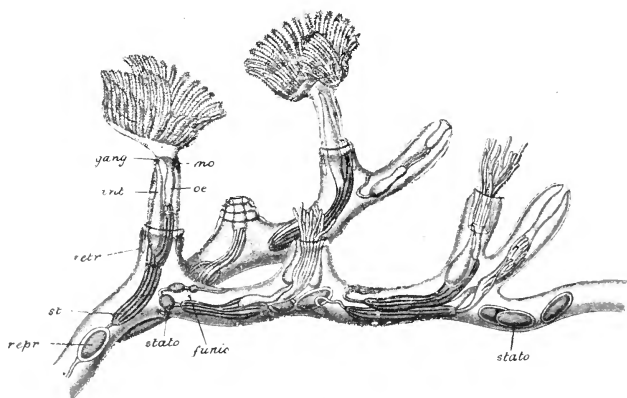

FIG. 285.—*Plumatella*. Portion of a colony, magnified. *funic.* funiculus; *gang.* ganglion; *int.* intestine; *mo.* mouth; *oc.* oesophagus; *repr.* gonad; *retr.* retractor muscle; *st.* stomach; *stato.* statoblasts. (After Allman.)

The zoecia open on the exterior by means of circular, semi-circular, or crescentic apertures, which in the Phylactolæmata and the Cyclostomata among the Gymnolæmata are devoid of any special closing apparatus; while in the Cheilostomata there is a movable lid or *operculum* closed by a pair of *occlusor* muscles when the introvert is retracted; and in the *Ctenostomata* there is a series of lobes or teeth which close in together over the opening. The cavities of the neighbouring zoecia are in some forms completely cut off from one another by a continuation of the chitinous or calcareous exoskeleton; in others there is free communication; in others, again, there is communication through a number of minute perforations.

The oral (anterior) part of the body of each zooid is, as already

described in the case of *Bugula*, covered only with a thin and flexible cuticle, and forms an *introvert* capable of being retracted into the interior of the zoëcium. At the free end of the introvert is the mouth surrounded by a lophophore bearing tentacles. The tentacles are always simple, filiform, and hollow, each containing a narrow diverticulum of the *circular canal* or anterior compartment of the coelome. They are beset with vibratile cilia by means of which currents are created subserving alimentation and respiration. They are also highly sensitive, and are capable of being bent about in various directions by the contraction

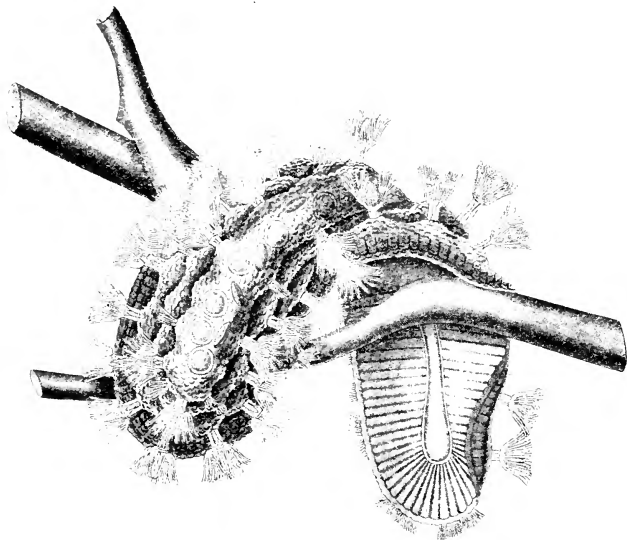

FIG. 286.—*Cristatella mucedo*. Entire colony. (After Allman.)

of muscular fibres in their walls, so that they can be used for prehension. In the *Phylactolæmata* (Fig. 285) the lophophore is horse-shoe-shaped, in the *Gymnolæmata* (Fig. 281) circular: in the former, but not in the latter, there is a ciliated lobe, the *epistome* (Fig. 287, *ep.*)—which may have a sensory function—overhanging the mouth on the anal side. The retraction of the introvert is effected by a pair of bands of muscular fibres, the *parieto-vaginal* muscles, passing to it from the body-wall, and by a pair of retractor muscles passing from the latter to the alimentary canal.

Structure of Body-wall.—Beneath the cuticle is an epidermis, consisting of a single layer of flattened polygonal cells, firmly united together by their edges. Beneath this there is usually, but not always, a layer of muscle, which is

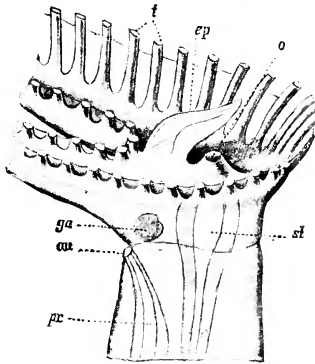

FIG. 287.—Anterior portion of the body of *Lophopus*, from the right side. *an.* anus; *ep.* epistome; *ga.* ganglion; *o.* mouth; *pr.* intestine; *st.* oesophagus; *t.* tentacles, cut off near the base. (From Lang's *Comparative Anatomy*. After Allman.)

is arranged in two strata—an external composed of circular, and an internal of longitudinal fibres. There is an extensive cœlome lined in some forms (*Phylactolæmata*) by a definite cœlomic epithelium, in part ciliated; while in others there is no such definite epithelium, but its place is taken by thin parietal and visceral layers of an irregular cellular tissue—the *parenchyma*. Crossing the cœlome are strands, in some instances very numerous, of spindle-shaped cells. In some cases two mesenteric bands suspend the alimentary canal—an anterior attached near the mouth and a posterior passing

from the cæcum to the aboral end of the zoecium; in most cases the latter, to which the special name of *funiculus* is given, is alone present.

The **alimentary canal** has in all species the parts that have been already described in the case of *Bugula*. In some of the *Cheilostomata* it is stated that the cells of the œsophagus bear numerous striated muscle-fibre processes. In some *Ctenostomata* there is in addition a thick-walled chamber—the *gizzard*—with chitinous teeth, between the œsophagus and stomach.

The **nervous system** consists of a single, sometimes bilobed, ganglion (Fig. 285, *gang.*, and Fig. 287, *ga.*) placed between the mouth and the anal aperture, and of nerves passing from it to the various parts. There are never any organs of special sense, unless the epistome of the *Phylactolæmata* be of that nature.

Nephridia are not known with certainty to exist in any of the *Ectoprocta*. In some there is a pore through which water enters the body-cavity, or a ciliated *intertentacular tube* opening at the base of the tentacles. Excretion appears to be performed by certain cells of the funicular tissue and of the *parenchyma* or cœlomic epithelium. These become loaded with the products of excretion, and are set free as leucocytes in the cœlome, whence

they may pass out through the intertentacular tube or may accumulate in the cells of the *brown body*.

In many Ectoprocta the colony bears a series of remarkable appendages—the **avicularia**—which are of the nature of modified zooids. In typical cases the avicularium has the bird's-head-like form that has been already described in the case of *Bugula*; sometimes it is completely sessile. A second set of movable appendages found in some forms are the **vibracula**; these are long tapering whip-like appendages which execute to-and-fro movements. Intermediate forms between avicularia and vibracula show that the latter are extreme modifications of the former. The avicularia are frequently found to have seized in their jaws minute Worms or Crustaceans, and it is probable that their function, as well as that of the vibracula, is defensive; in the case of the *Selenariidæ*, which form unattached colonies, it is said that the movements of the vibracula subserve locomotion.

The impregnated ova in many cases undergo the early stages of their development in certain dilatations of the colony (Fig. 281, *oec.*), and in many of the Gymnolæmata (Cheilostomata) these *ovicells* or *oecia*, as they are termed, take on a very definite shape.

Reproduction and Development.—In general the Ectoprocta are hermaphrodite. Both ovary and testis are derived from the layer lining the cœlome (parenchyma or cœlomic epithelium as the case may be), or from the funicular tissue. The testis may be single or double. The spermatidia, as in *Bugula*, or the mature sperms. become free in the cœlome. The ovary is very generally situated towards the oral end or about the middle, the testis towards the base. The mature ova escape into the cœlome, and in some forms there become impregnated apparently by the spermatozoa of the same individual. The development of the larva may take place in the cœlome or in a special diverticulum of it; in the Cheilostomata the fertilised ova pass into the *ovicells*; in some cases, both among the Phylactolæmata and the Gymnolæmata, they are received into a sheath formed by the tentacles of an imperfectly-developed zooid formed in a *zoœcium* in which the original zooid had undergone degeneration.

In those cases in which the early stages of development are passed through in the body-cavity of the parent, the ciliated embryos may either escape through the *zoœcial* aperture after the zooid has undergone degeneration, or through a special opening formed for them in the wall of the *zoœcium*. In some the fertilised ova pass out through the intertentacular tube, which plays the part of an oviduct. In *Crisia* and other Cyclostomata each of the ripe *oecia* is found to contain a large number of embryos, developed from one ovum. The ovum in this genus segments to form a mass of cells from which finger-like processes arise, the end of each of these becoming constricted off to form an embryo.

Segmentation is total and approximately equal. The form of the free-swimming larva varies considerably, but in most there is a circular band with very long cilia, the *corona*, which may represent the tentacular crown of the adult; this divides the surface into two regions—oral and aboral. The larva may or may not be provided with a digestive canal. The aboral portion of the body presents a ciliated *retractile disc* or *calotte*, which subsequently becomes a closed sac destined to give origin to the primary zooid of the colony; on the oral side is the *sucker* by which the larva afterwards becomes fixed. By a metamorphosis similar to that which has been described in the case of *Bugula* (p. 338), a primary zoecium with a primary zooid is developed from the previously free ciliated larva. In *Membranipora*, which belongs to the Cheilostomata, and in several genera of Ctenostomata, the larva (called *Cyphonautes* when it was supposed to be an adult animal) is laterally compressed, with a bivalve shell. In the Cyclostomata the larva is barrel-shaped, with the mouth at one end, and at the other a prominence corresponding to the retractile disc. In the Phylactolæmata the larva is in the form of a ciliated hollow cyst from which the colony is formed by gemmation. A special form of asexual multiplication by means of bodies termed *statoblasts* (Fig. 285, *stato*) is observable in the Phylactolæmata. The statoblasts are internal buds formed from the funiculus and enclosed in a chitinous shell; they are set free eventually by the death and decay of the parent colony, and each gives rise to a small zooid which fixes itself and develops into a colony.

Ethology and Distribution.—None of the Ectoprocta are parasites in the strict sense of the term, but very many of them live in intimate association with other organisms, often growing over and through them so as to form with them one complex structure. Certain genera are able by some means to excavate minute burrows in the shells of bivalves.

The majority of Ectoprocta are marine; but all the Phylactolæmata, together with Paludicella of the Ctenostomata, are inhabitants of fresh water. The fresh-water forms inhabit both running and stagnant waters; they occur at all elevations and are represented in all the great regions of the earth's surface. The marine forms are most abundant at moderate depths; but representatives of the group have been dredged from as great a depth as over 3,000 fathoms. In certain localities the larger kinds grow in great luxuriance, so as to form miniature forests.

Geologically the Ectoprocta are a very ancient group, being represented in the Cambrian and later Palæozoic formations by forms which appear to have belonged mainly, if not exclusively, to the Cyclostomata. In the later formations of the Mesozoic period the Cheilostomata are also abundantly represented, and in the

Tertiary the latter sub-order greatly outnumbers the Cyclostomata. The Tertiary Polyzoa flourished in certain localities in such luxuriance that their remains form calcareous deposits of very great extent.

Sub-Class II.—Endoprocta.

While the sub-class of the Ectoprocta comprises a large number of genera, that of the Endoprocta includes only *Pedicellina* (Fig. 288), *Loxosoma*, *Urnatella*, *Myosoma*, *Gonopodaria* and *Ascopodaria*, with one or two other less completely known forms. They are all marine except *Urnatella*—an American fresh-water genus. The feature indicated by the name of the sub-class—viz. the position of the anus within the circle of the tentacles, is an important point of difference from the rest of the class; but there are others of as great or greater importance.

In none of the Endoprocta is there a distinct introvert. The body is cup-shaped, with a rim which is capable of being inverted over a cavity—the *vestibule*—within which the tentacles can be withdrawn, and which contains both mouth and anus. An *epistome* overhangs the mouth. The cœlome is almost or quite obliterated, the space between the alimentary canal and the wall of the

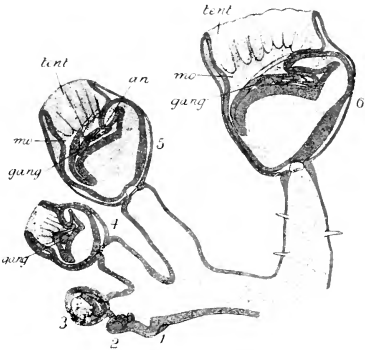

FIG. 288.—*Pedicellina*. Showing successive stages (numbered 1 to 6) in the development of zooids by budding. an, anus; gang, ganglion; mo, mouth; tent, tentacles (retracted). (After Hatschek.)

body being filled, more or less completely, with a gelatinous hyaline matrix. A pair of *nephridia* are present. In *Loxosoma* they lie one on either side of the œsophagus and open separately on the exterior; they are ciliated intra-cellular tubes, each of which probably begins in a flame cell. In *Urnatella* the two nephridial tubes unite to open into the *cloaca*—a diverticulum of the vestibule. The *ganglion* (Fig. 288, *gang.*), situated between mouth and anus as in the Ectoprocta, is bilobed in *Loxosoma*. *Testes* and *ovaries* occur in the same individual in some, but appear to mature at different times: they are provided with special ducts; in others the sexes are separate.

Pedicellina and *Urnatella* are colonial, *Loxosoma* solitary. In *Pedicellina* (Fig. 288) there is a creeping stolon with which a number of zooids are connected; a diaphragm separates the body

of each zooid from the stalk. *Gonopodaria ramosa* has a branching stalk. Umbratella has a disc of attachment with one to six, jointed, branching stems. In *Loxosoma*, which is found attached to various Annulata, two parts are distinguishable—the calyx or *body* and the *stalk*. In the base of the latter is the so-called *foot-gland*, consisting of a small number of granular cells arranged around a central space opening on the exterior. Buds are formed, but become detached before reaching maturity. Segmentation of the ovum is complete, and a gastrula is formed by invagination.

Certain differences in the larval history have sometimes been regarded as separating very widely the Endoprocta from the Ectoprocta. The former, like the latter, have a free-swimming ciliated larva, provided with a corona and a ciliated disc. This develops directly into the primary zooid after becoming attached by means of the oral surface. The ectoproct larva also, as stated previously (p. 346), becomes attached by the oral surface; but any rudiments of a zooid—such as an alimentary canal—which may have been developed, become absorbed, and the primary zooid is developed at the free or aboral end of the larva, with its oral surface directed upwards, away from the base of attachment. The difference, however, is not so important as it may at first appear, for the parts of the larval Endoproct do not remain in the reversed position in which they are situated when attachment first takes place, with the vestibule, mouth, and anus directed downwards. Very soon a rotation is observed to take place, by virtue of which the vestibule and developing tentacles, with the mouth and anus, become carried to their permanent position on the free surface of the animal.



FIG. 289.—*Phoronis australis*, natural size.

CLASS II.—PHORONIDA.

The position of *Phoronis* and its close ally, *Phoronopsis*, worm-like marine animals, is a matter on which widely divergent views are held. On account of certain strong resemblances to the Polyzoa, and, more particularly, to the Phylactolæmata they are most commonly looked upon as related to that class and to the Brachiopoda, and the Phoronida may thus conveniently be dealt with as a class of the Molluscoidea.

Phoronis (Fig. 289) lives in associations consisting of a number of individuals. These are usually looked upon as having all been deve-

loped from ova. But multiplication by fission has been proved to occur actively in one species, and probably increase in the numbers of the association is effected in this manner throughout the group. Each worm is enclosed in a membranous or leathery tube, within which it is capable of being completely retracted. The body, which varies in length in the different species from 1.5 to 127 mm., is cylindrical, elongated, and unsegmented. At one end there is a crown of numerous slender, ciliated tentacles borne on a horse-shoe-shaped lophophore, the lateral cornua of which are spirally coiled in the larger species; these are supported by a mesodermal skeleton and are non-retractile.

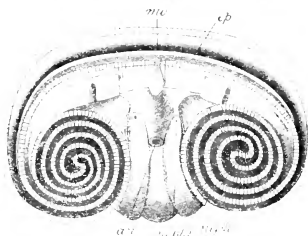

FIG. 290.—*Phoronis australis*, free end magnified. *an.* anus; *ep.* epistome; *mo.* mouth; *neph.* nephridial aperture; *neph.* nephridium. (After Benham.)

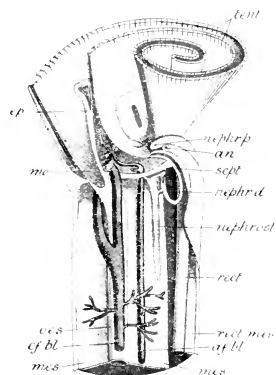

FIG. 291.—*Phoronis australis*, internal organisation. *af. bl.* afferent blood vessel; *an.* anus; *ef. bl.* efferent blood vessel; *ep.* epistome; *mes.* mesentery; *mo.* mouth; *neph. p.* nephridiopore; *neph. d.* duct of nephridium; *nephrost.* nephrostome (internal opening of nephridium); *oes.* oesophagus; *rect.* rectum; *rect. mes.* rectal mesentery; *sept.* septum; *tent.* tentacles (cut short). (After Benham.)

Both mouth and anus (Fig. 290, *mo.*, *an.*) are situated at this tentacular extremity of the body, separated from one another by only a short space. This short space between mouth and anus represents, as in the Polyzoa, the greatly abbreviated *dorsal surface*; but it will be convenient to term this end of the animal the anterior, and the opposite the posterior end: the side of the elongated body towards which the mouth is approximated may be distinguished as the *oral*, the opposite as the *anal*. A broad lobe—the *epistome* (*ep.*)—overhangs the mouth and lies between it and the anus. Near the anus open two ciliated *nephridial tubes* (*neph.*) of mesodermal origin, which open internally each by two apertures into the posterior chamber of the cœlome.

The *calome*, which is lined with a cœlomic epithelium, is divided into two parts of very unequal extent by a partition or mesentery which runs across just behind the tentacles. The anterior part is in communication with cavities in the tentacles and the epistome.

The posterior, and by far the most extensive part of the coelome, occupies the whole of the length of the body behind the transverse partition. It is subdivided into two by a median longitudinal mesentery (Fig. 292, *m.*, *m.*), which extends from the oral to the anal surface and supports both limbs of the alimentary canal; and each of these is further subdivided by a longitudinal mesentery extending from the body-wall to the oesophagus (α .) in the one compartment (usually termed the right), and to the rectum (*r.*) in the other (left). The *alimentary canal* is bent on itself to form a loop, as in the Polyzoa: it is distinguishable into

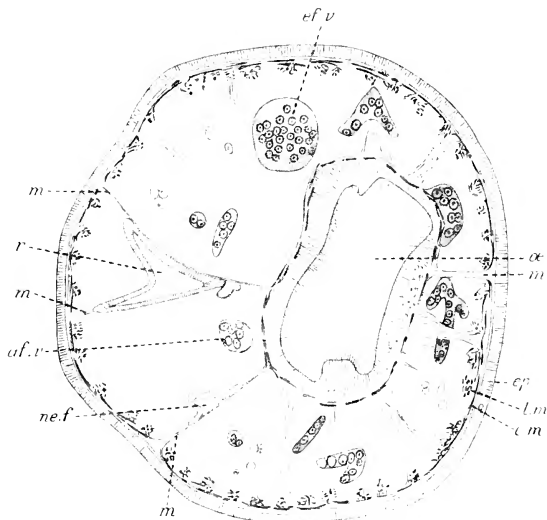

FIG. 292.—**Phoronis**, transverse section towards the anterior end. *af. v.* afferent blood-vessel; *c. m.* circular layer of muscular fibres; *ef. v.* efferent blood-vessel; *ep.* epidermis; *c. m.* circular layer of muscle; *m., m.* mesenteries; *ne. f.* funnel-like opening of nephridium; α . oesophagus; *r.* rectum. (After Benham.)

oesophageal, gastric and intestinal regions. There is a closed system of *blood-vessels* with contractile walls containing red blood-corpuscles. The *nervous system* lies immediately below the cells of the epidermis. Nerve-elements are generally distributed over the surface, but are specially concentrated in the form of a ring surrounding the body just behind the mouth, but not enclosing the anus, thickened into a ganglion between mouth and anus, and giving off nerves to the tentacles. There are no organs of special sense.

Phoronis is hermaphrodite. Ova and sperms are developed in

the cœlome towards the posterior end from cells on the wall of one of the large blood-vessels. When mature these pass out through the nephridia to the spaces enclosed by the tentacles, where the ova are impregnated (—according to another account, fertilisation takes place in the cœlome—), and they go through the early stages of development fixed to the tentacles. The segmentation is complete and slightly unequal: when four blastomeres are formed two larger, darker endoderm and two smaller, clearer ectoderm cells are to be distinguished. A blastula is formed with clearer ectoderm cells on one side; invagination takes place; and, as the embryo elongates, the blastopore is drawn out into a slit which eventually becomes closed up behind, the anterior portion alone remaining open to form the mouth. The

anus is developed later as an invagination in the position of the posterior part of the former blastopore. The mesoderm arises from cells budded off from the endoderm. The prosocœle and mesocœle arise by the formation of fissures; the metacœle by a process of folding off from the archenteron. A large pre-oral lobe is formed, and the anus becomes surrounded by a cirlet of cilia (Fig. 293, *t. tr.*). The part of the body on which the anus is situated becomes elevated into a conspicuous process. Behind the mouth there is a cirlet of cilia, and from this region

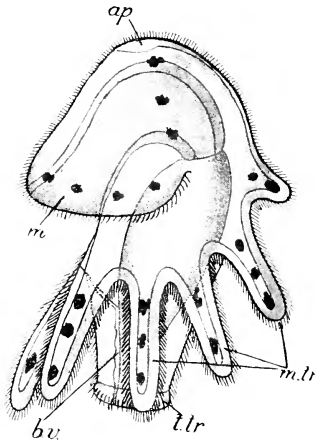

FIG. 293.—*Actinotrocha* larva of *Phoronis*, lateral view. *ap*, apical plate; *b.v.*, blood-vessel; *m.*, mouth; *m. tr.*, cirlet of cilia and tentacles; *t. tr.*, cirlet of cilia round anus. (From MacBride, after Metschnikoff)

grow out a cirlet of processes—the rudiments of the larval tentacles (Fig. 294, *B*). The larva has now reached the stage to which the term *actinotrocha* is applied. It has a large hood-like lobe overhanging the mouth and a cirlet of ciliated larval tentacles; the anus is situated on a prominent process.

There is a pair of larval excretory organs corresponding to those of the trochophore larva; these have no cœlomic apertures, but are provided with *solenocytes* (see Section X, Annulata). They apparently do not become converted into the nephridia of the adult. A thickening of the ectoderm of the pre-oral lobe, sometimes bearing eyespots, appears to represent the apical plate of the trochophore. At the point where the œsophagus opens into it, the gastric region of the alimentary canal gives off forwards in one

species a pair of hollow diverticula, the cells of which contain vacuoles like those of the neighbouring parts of the stomach itself (Fig. 294, *C, gl.*).

The ectoderm of the process on which the anus is situated subsequently becomes involuted to form a deep pit (Fig. 294, *A*), and rudiments of the adult tentacles (*B, a. ten.*) are formed as a ring

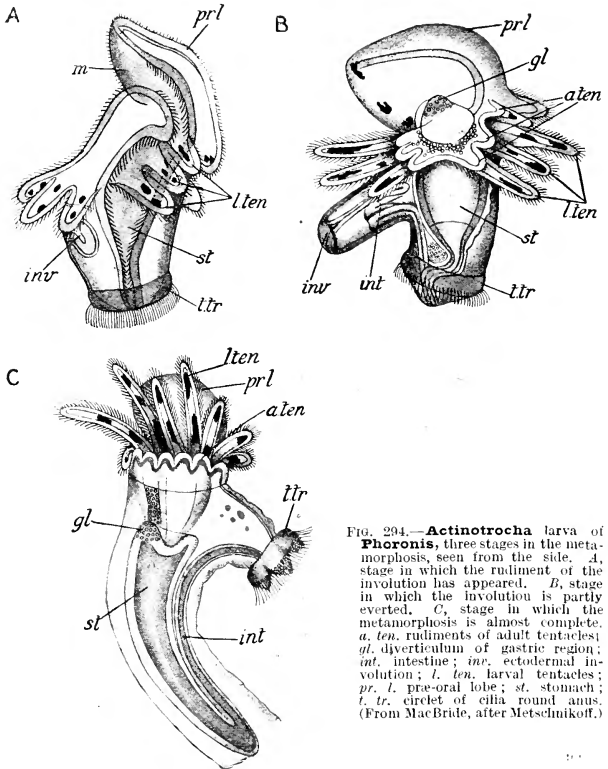

FIG. 294.—*Actinotrocha* larva of *Phoronis*, three stages in the metamorphosis, seen from the side. *A*, stage in which the rudiment of the involution has appeared. *B*, stage in which the involution is partly everted. *C*, stage in which the metamorphosis is almost complete. *a. ten.* rudiments of adult tentacles; *gl.* diverticulum of gastric region; *int.* intestine; *inv.* ectodermal involution; *l. ten.* larval tentacles; *pr. l.* pre-oral lobe; *st.* stomach; *t. tr.* circlet of cilia round anus. (From MacBride, after Metschnikoff.)

of processes at the bases of the larval tentacles. The metamorphosis from this point is completed with great rapidity. The larva sinks to the bottom; the pit at the side of the anal elevation becomes everted (*B, inv.*) and the alimentary canal of the larva is drawn into it (*C*), the projection thus formed, which grows out at right angles with the long axis of the larva, becoming the body of

the future animal; the larval tentacles and pre-oral lobe are thrown off, and the lophophore is developed.

The Phoronida have a wide geographical distribution, occurring in all the chief regions. Some of the species live about low-water mark: others at moderate depths up to about thirty fathoms. Some of the associations take the form of encrustations of the matted tubes. In other cases the tubes lie in excavations in stone or in the shells of Molluscs. In one species the tubes occupy channels in the substance of the tube of a Sea-anemone.

CLASS III.—BRACHIOPODA.

The Brachiopoda are the fabricators of the well-known "Lampshells" found in most parts of the world. They occur in the sea at various depths, and were formerly classed under the Mollusca, their characteristic bivalved shell being compared with that of oysters, mussels, &c.

1. EXAMPLE OF THE CLASS—*Magellania* (*Waldheimia*) *lenticularis* or *M. flavescens*.

Magellania lenticularis is found in great numbers, at moderate depths, off the coast of New Zealand. An allied species, *M. flavescens*, is equally common in the Australian seas, and several other species are known in various parts of the world.

The body is entirely covered by a shell (Fig. 295) of oval form and pink colour, composed of two pieces or *valves*, one of which, distinguished as the *ventral valve* (*v. v.*), projects beyond the other or *dorsal valve* (*d. v.*), in the form of a short conical *beak* (*b*) perforated at the end by an aperture, the *foramen* (*b*), through which passes a dark brown stalk or *peduncle* (Fig. 296, *B*, *pd*) of horny consistency. In the natural state the peduncle is attached to a rock or other support, and the animal lies with the ventral valve uppermost and with the valves gaping slightly. The pointed or peduncular end of the shell is considered to be posterior in position, the opposite end or gape anterior.

It will be convenient to consider the shell first. Both valves are deeply concavo-convex, of a pinkish or brown colour outside, white within. The ventral valve (Fig. 295), as already stated, is produced posteriorly into a beak (*b*), terminating in a foramen (*f*) for the peduncle. The distal margin of the foramen is left incomplete by the shell proper, but is closed by a small double plate, the *deltidium* (*d*). Immediately anterior to the beak is the curved *hinge-line* along which the valve articulates with its fellow, and just anterior to the hinge-line the inner surface of the shell is produced into a pair of massive, irregular *hinge-teeth* (*t*). On the inner surface of the valve, towards its posterior end, are certain shallow depressions marking the attachments of muscles (*ad.m.*, *d. m.*).

The dorsal valve (*D*) has no beak, but its posterior edge forms a hinge-line which is produced in the middle into a strong *cardinal process* (*c. p.*) with a curiously folded surface: when the two valves are in position this process fits between the hinge-teeth of the ventral valve, the hinge-teeth in their turn being received into depressions (*s*) placed on each side of the cardinal process. The inner surface of the dorsal valve is produced into a median ridge or

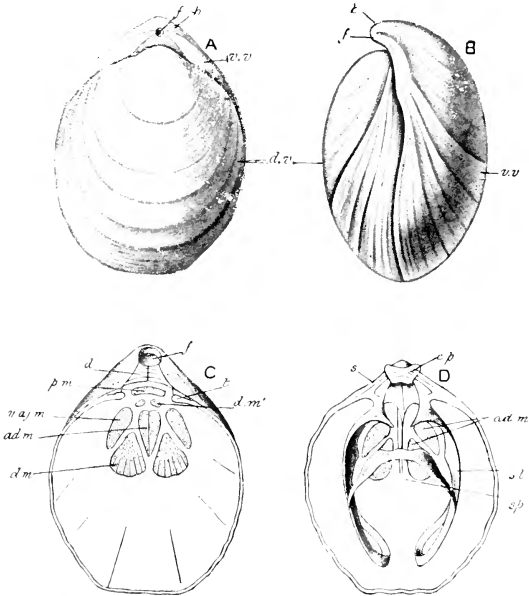

FIG. 295.—*Magellania flavescens*. *A*, the entire shell from the dorsal aspect, and *B*, from the left side; *C*, interior of ventral valve, and *D*, of dorsal valve. *ad. m.* adductor impressions; *b.* beak; *c. p.* cardinal process; *d.* deltidium; *d. m.* divaricator impressions; *d. v.* dorsal valve; *f.* foramen; *p. m.* protractor impressions; *s.* tooth-socket; *s. l.* shelly loop; *sp.* septum; *t.* hinge-tooth; *v. a. m.* adjustor impressions; *v. v.* ventral valve. (After Davidson.)

septum (*sp*), continuous posteriorly with the cardinal process, and attached on either side of the base of the latter are the two ends of a delicate calcareous ribbon, the *shelly loop* (*s. l.*), which projects freely into the cavity enclosed between the two valves, and has the form of a simple loop bent upon itself. The inside of the dorsal valve also has muscular impressions.

Externally both valves present a series of concentric markings parallel with the edge or gape: these are lines of growth, the

shell being built up by new layers being deposited within those previously formed, and projecting beyond them so as to form a series of outcrops.

Microscopically the shell consists of prismatic rods or spicules of carbonate of lime, placed obliquely to the surface and separated from one another by a thin layer of membrane. It is also traversed, perpendicularly to the surface, by delicate tubules which begin on the inner surface in microscopic apertures and extend to within a short distance of the outer surface.

The actual **body** of the animal (Fig. 296, *B*) lies at the posterior end of the shell, occupying not more than a third of the space enclosed between the two valves: it is consequently more or less wedge-shaped in form, and presents dorsal and ventral surfaces in contact with the two valves, and an anterior surface looking towards the gape. The dorsal is of greater extent than the ventral surface, so that the anterior surface is placed obliquely.

The dorsal and ventral regions are continued each into a flat reduplication of the body-wall, closely applied to the corresponding valve and containing a prolongation of the cœlome. The two flaps thus formed are the *dorsal* (*d. m*) and *ventral* (*v. m*) *mantle-lobes*. They are fringed with minute setæ (*s*) lodged in muscular sacs, like those of *Chaetopods* (*vide* Sect. X.), and give off from their outer surfaces hollow processes which extend into the tubules of the shell mentioned above.

The large wedge-shaped space or *mantle-cavity*, bounded by the mantle-lobes above and below, and behind by the anterior surface of the body, is occupied by a huge and complex *lophophore* (Figs. 296 and 297, *lph*), which springs from the anterior surface of the body, and, like that of the fresh-water *Polyzoa* and of *Phoronis*, has the general form of a horse-shoe. It is, however, peculiarly modified: the two limbs of the horse-shoe curve towards one another so as to adapt themselves to the mantle-cavity; and the middle of the concave edge, which is dorsal in position, is produced into a spirally coiled offshoot (*lph'*) which lies between the two arms and is coiled towards the dorsal side. The lophophore is hollow, containing a spacious cavity or sinus: its two main arms also receive prolongations of the cœlome into which the digestive glands project: it is fringed throughout its whole extent with long ciliated tentacles which form the outer boundary of a ciliated *food-groove*, bounded on the inner side by a wavy ridge or *lip* (*lp*, *lp'*). By the action of the cilia microscopic particles are swept along the food-groove to the mouth.

Digestive Organs.—The *mouth* (*mt*) is a narrow crescentic aperture situated in the middle of the lophophore, towards its convex or ventral edge, and is bounded dorsally by the lip. It leads into a V-shaped enteric canal which consists of a *gullet* passing upwards from the mouth, an expanded *stomach* (*st*), and a

straight *intestine* (*int.*) which extends from the stomach downwards and backwards towards the ventral surface and ends blindly,

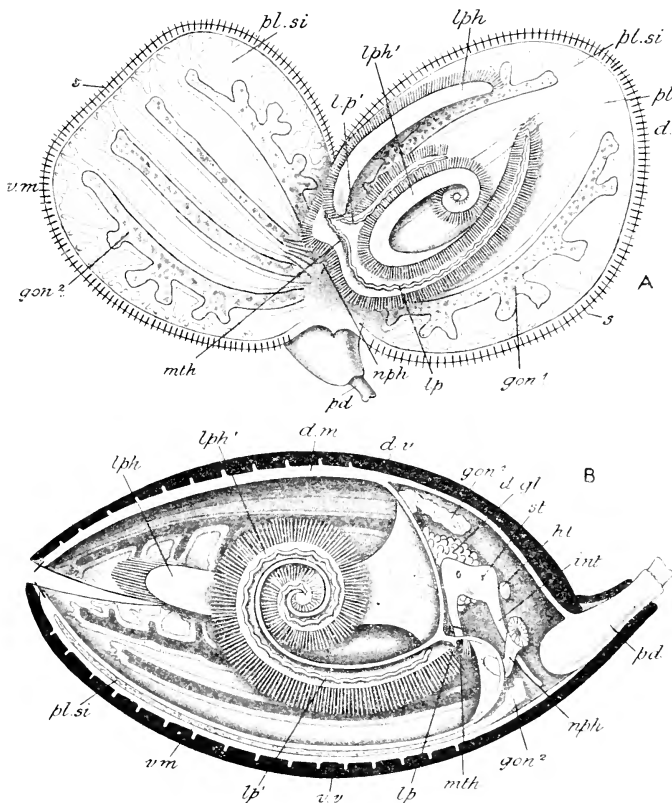

FIG. 296.—*A*, Body of *Magallania lenticularis*, removed from shell; *B*, sagittal section of the entire animal. Both semi-diagrammatic, the lophophore being represented as of smaller proportional size than in the actual animal (cf. Fig. 297). *d. gl.* digestive gland; *d. m.* dorsal mantle-lobe; *d. v.* dorsal valve of shell; *gon'*, *gon''*, gonads; *ht*, heart; *int.* intestine; *lp*, *lp'*, lip; *lph*, lophophore; *lph'*, its coiled process; *mth*, mouth; *nph*, in *B*, nepridium, in *A*, nepridial aperture; *pd*, peduncle; *pl. si.* pallial sinuses; *s*, seta; *st*, stomach; *v. m.* ventral lobe of mantle; *v. v.* ventral valve of shell.

there being no anus. On each side of the stomach, and opening into it by a duct, is a large, branched *digestive gland* (*d. gl.*). The whole canal is lined with ciliated epithelium.

The **body-wall** consists externally of an epidermis formed of a single layer of cells, then of a layer of connective tissue, of a cartilaginous consistency in many parts, and finally of a ciliated cœlomic epithelium lining the body-cavity. On the outer surfaces of the mantle-lobes, where they are in contact with the shell, the epidermis is replaced by a thin membrane showing no cell-structure.

The **muscular system** (Fig. 298) is well developed. Two large *adductor muscles* (*ad. m.*) arise on each side from the dorsal valve, and passing downwards, unite with one another so as to have a single insertion on the ventral valve: their action is to approximate the valves and so to close the shell.

A large and a small pair of *divaricators* (*d. m.*, *d. m'*) arise from the ventral valves, and are inserted into the cardinal process, which they depress: as this process is situated posteriorly to the hinge-line, its depression raises

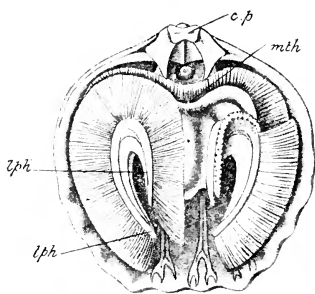

FIG. 297.—**Magellania flavescens**, the ventral valve removed. *c. p.* cardinal process; *lph.* arm of lophophore; *lph1.* its coiled process, with the tentacles removed on the right side; *mth.* mouth. (After Davidson.)

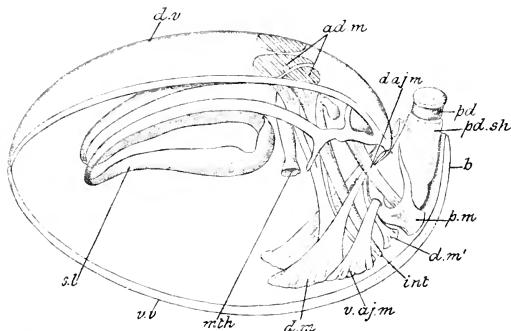

FIG. 298.—Muscular system of **Magellania**. *ad. m.* adductors; *b.* beak; *d. aj. m.* dorsal adjustors; *d. m.*, *d. m'* divaricators; *d. v.* dorsal valve; *int.* intestine; *mth.* mouth; *pd.* peduncle; *pd. sh.* sheath of peduncle; *p. m.* protractor; *s. l.* shelly loop; *v. aj. m.* ventral adjustors; *v. v.* ventral valve. (After Hancock.)

the rest of the dorsal valve and so opens the shell. Two pairs of muscles arising, one from the ventral, the other from the dorsal valve, and inserted into the peduncle, are called *adjustors* (*aj. m.*):

the peduncle being fixed, they serve to alter or adjust the position of the animal as a whole by turning it in various directions.

The **cœlome** is a spacious cavity more or less encroached upon by the muscles and other organs, and traversed by sheets and bands of membrane which connect the enteric canal with the body-wall, and thus act as mesenteries. The cœlome is continued into each of the mantle-lobes in the form of four canals or *pallial sinuses* (Fig. 296, *pl. si*), the two outer of which are extensively branched.

Blood-system.—Attached to the posterior region of the stomach is a small, almost globular sac (*h*), which has been proved to be contractile and is to be considered as a *heart*. Vessels have been traced from it to various parts of the body, but the relations of the whole circulatory system and the course of the circulation are very imperfectly known.

The **excretory organs** consist of a pair of very large *nephridia* (*nph*) lying one on each side of the intestine. Each is funnel-shaped, having a wide inner opening or *nephrostome*, with plaited walls, opening into the cœlome, and a narrow, curved,

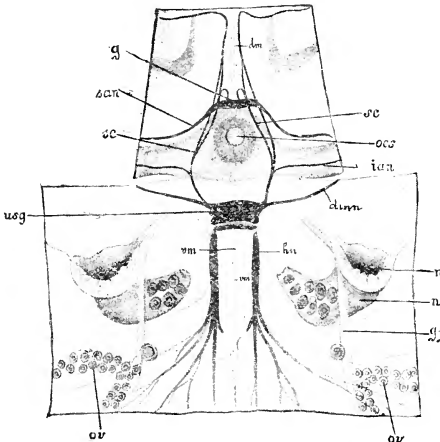

FIG. 299.—Anterior body-wall of *Terebratula*, to show nervous system, &c. *dm*, dorsal mesentery; *g*, brain; *u*, genital folds; *n*, nephridium; *nt*, nephrostome; *usg*, gullet; *ov*, ovary; *sc*, oesophageal connective; *usg*, infra-oesophageal ganglion; *dmn*, *hn*, *san*, nerves. (From Lang's *Comparative Anatomy*, after van Beemelen.)

outer portion which opens into the mantle-cavity not far from the mouth. As in many cases which have already come under our notice, the nephridia act also as gonoducts.

The **nervous system** (Fig. 299) is a ring round the gullet presenting supra- (*g*) and infra- (*usg*) oesophageal swellings or ganglia, of which the infra-oesophageal is the larger. Nerves are given off to the mantle, lophophore, &c. No special sense-organs are known.

Reproductive Organs.—The sexes are separate. There are two pairs of gonads (Fig. 296, *gon*), one dorsal and one ventral, in the form of irregular organs sending off branches into the pallial sinuses.

2. DISTINCTIVE CHARACTERS AND CLASSIFICATION.

The Brachiopoda are Molluscoida in which the body is enclosed in a shell formed of two parts or valves which are respectively dorsal and ventral in position. The body occupies only a small portion of the space enclosed by the shell, and is usually attached to foreign objects by a posteriorly placed stalk or peduncle: it gives off dorsal and ventral reduplications, the mantle-lobes, which line the valves of the shell and enclose a large mantle-cavity. From the anterior surface of the body is given off a lophophore which surrounds the mouth, and is beset with ciliated tentacles. There is a ridge-like pre-oral lip which is continued on to the lophophore. The enteric canal is usually V-shaped, and is divisible into gullet, stomach, and intestine: there is a pair of digestive glands. The cœlome is spacious, and is continued into the mantle-lobes. A heart is usually present, attached to the stomach. The excretory organs are one or two pairs of nephridia which act also as gonoducts. The nervous system is a ganglionated circum-œsophageal ring: sense-organs are usually absent in the adult. The sexes are separate or united. Development is accompanied by a metamorphosis.

The class is divided into two orders:—

ORDER 1.—INARTICULATA.

Brachiopoda in which the shell is mainly composed of chitinoid material with a varying proportion of calcified substance: the valves are not united by a hinge, and there is no shelly loop for the support of the lophophore. An anus is present.

Including *Lingula*, *Crania*, *Discina*, &c.

ORDER 2.—ARTICULATA.

Brachiopoda in which the shell is formed of oblique prisms or spicules of calcium carbonate: the two valves unite by a definite hinge, and there is usually a shelly loop, for the support of the lophophore, developed in connection with the dorsal valve. The intestine ends blindly.

Including *Magellania*, *Terebratula*, *Rhynchonella*, *Cistella* (*Argiope*), &c.

Systematic position of the Example.

The genus *Magellania*, of which there are several species, belongs to the family Terebratulidæ, and to the order Articulata.

The dissimilar valves of the shell articulated by teeth and sockets, and the absence of an anus, place it among the Articulata. The Terebratulidæ are distinguished by an oval or rounded shell, the structure of which is punctate, the dots corresponding with

blind tubes receiving processes of the mantle; the beak of the ventral valve is prominent, and has a foramen partly bounded by a deltidium of one or two pieces: there is a shelly loop springing from the hinge-line of the dorsal valve. The genus *Magellania* is characterised by having the shelly loop fully half as long as the shell itself, and by the presence of a median septum on the inner face of the dorsal valve.

The specific differences between *M. lenticularis* and *M. flavescens* are largely matters of detail, depending upon the precise form of the shell and loop. More obvious differences are seen in the shell, which is pink, evenly-rounded, and short-beaked in *M. lenticularis*, while in *M. flavescens* it is horn-coloured, almost pentagonal, and has a prominent beak.

3. GENERAL ORGANISATION.

The **shell** presents two distinct types: in the Articulata, the order to which *Magellania* belongs, the dorsal and ventral valves

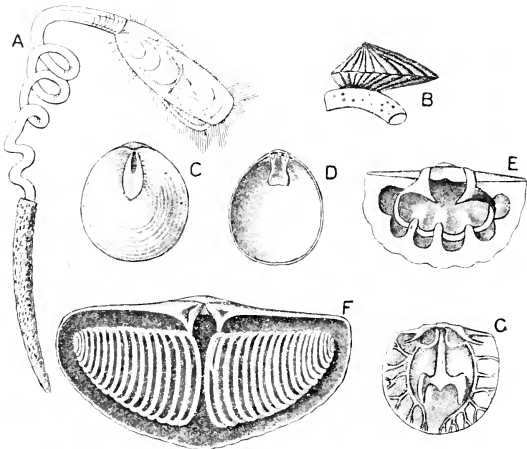

FIG. 300.—Typical Brachiopoda. *A*, *Lingula*; *B*, *Crania*; *C*, *Discina*; *D*, *Terebratula*; *E*, *Cistella*; *F*, *Spirifera*; *G*, *Kraussina*. (After Bronn.)

are dissimilar, the dorsal valve having a cardinal process and usually a shelly loop, the ventral a spout-like beak for the peduncle; while in the Inarticulata, of which *Lingula* is a good example (Fig. 300, *A*), the two valves are nearly alike, and there is no shelly loop and no beak. These differences are accompanied by differences in microscopic structure; in the Articulata the shell is dense and stony, and is formed of obliquely placed calcareous prisms, while in

the Inarticulata it has no prismatic structure, but usually consists of a chitinoid material more or less strengthened by calcareous spicules, or of alternate chitinoid and calcareous layers. A system of tubules, such as that described above in the case of the example, occurs in many cases. Among the Articulata the loop may be absent; when present, it varies greatly in form and size, being sometimes very small and simple (Fig. 300, *C*, *D*), sometimes bent upon itself, as in *Magellania*, sometimes attached to the septum or to the interior of the dorsal valve (*E*), sometimes, as in the extinct *Spirifera*, represented by a complex double spiral (*F*), sometimes reduced to short, paired rods springing from the septum (*G*). The shell is secreted partly by the general surface of the body, partly by the folds of the mantle.

In some cases **spicules** occur scattered through the soft parts.

The majority of both orders are attached by a longer or shorter **peduncle** which passes between the proximal ends of the valves in *Lingula* (Fig. 300, *A*), through a

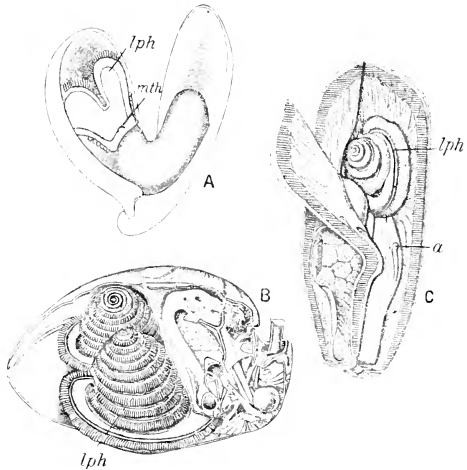

FIG. 301.—Dissections of *A*, *Cistella*; *B*, *Rhynchonella*; and *C*, *Lingula*. *a*, anus; *lph*, lophophore; *mth*, mouth. (After Schulgin and Hancock.)

perforation in the ventral valve in *Discina* (*C*), and through a foramen in the spout-like posterior end of the ventral valve in the Articulata. *Crania* (*B*) has the ventral valve fixed directly to foreign objects, the peduncle being absent.

The **lophophore** is found in its simplest form in *Cistella* (Fig. 301, *A*), in which it is a horse-shoe-shaped disc with very short arms, attached to the dorsal mantle-lobe, of which it is a prolongation, and surrounded with flexible tentacles which project between the valves. From this the lophophore of *Magellania*, which may be considered as typical for the Articulata, is easily derived by an increase in size, and by the prolongation of the middle region of the concave edge into a coiled offshoot. In the Inarti-

culata (*C*), and in Rhynchonella (*B*) among the Articulata, each arm of the horse-shoe is coiled into a conical spiral, which in some cases can be protruded between the valves. In all cases a section of the arm shows the same general character, with a groove, one of the lips of which is a simple ridge, while the other is the row of tentacles.

The most noteworthy point about the **muscular system** is the fact that the shell is both opened and closed by muscular action. The dorsal valve may be taken to represent a lever of which the hinge-line is the fulcrum, the cardinal process the short arm, and the main portion of the valve the long arm. The mode of action of the three principal sets of muscles—adductors, divaricators and adjustors—has been described in the account of the example (p. 357). In *Lingula* there is a very complex muscular system by means of which the valves can be rubbed upon one another, or moved laterally as well as opened and shut.

In the Articulata the **enteric canal** is V-shaped, as in Magellania, the intestine being straight or nearly so, and ending blindly. In the Inarticulata, on the other hand, the intestine is usually coiled, and always ends in an anus (Fig. 301, *C*, *a*), which generally opens into the mantle-cavity, but in one genus (*Crania*) into a pouch or sinus at the posterior end of the body between the valves.

A **heart** is usually present, but the function of blood is performed mainly by the cœlomic fluid, which is propelled by the cilia lining that cavity, and circulates both in the cœlome itself and in the pallial sinuses, each sinus presenting—in *Lingula* at least—both an outgoing and an ingoing current.

A single pair of **nephridia**, resembling those of Magellania, occurs in all known genera except Rhynchonella, in which there are two pairs, one dorsal and one ventral. Besides discharging an excretory function they act as gonoducts.

The **nervous system** always takes the form of a circum-œsophageal ring with ganglionic enlargements, the largest of which is ventral or sub-œsophageal in position. Otocysts have been described in *Lingula*, rudimentary eyes in *Megerlia*, and patches of sensory epithelium in *Cistella*: with these exceptions sensory organs are unknown.

There are usually four **gonads**, two dorsal and two ventral, sending prolongations into the pallial sinuses. Some genera are dioecious, others hermaphrodite, the epithelium of the gonads producing, in the latter case, both ova and sperms.

The **embryology** and **larval history** of the Brachiopoda have been worked out only in four genera belonging to the Articulata and one (*Lingula*) belonging to the Inarticulata. The following are the chief general characteristics of the development in the former. In three of the four genera referred to the earlier stages

are passed through in brood-pouches; in the fourth the eggs are only attached temporarily to the setae of the parent and become free in a comparatively immature condition. Segmentation is regular and complete, and results in the formation of a ciliated blastula, the wall of which is composed of cells of like character throughout. This is converted into a gastrula by invagination (Fig. 302, *A*): the blastopore narrows to a slit and gradually completely closes. The stomodæum arises as an invagination of the surface ectoderm apparently in the position of the anterior end of the former blastopore. An ectodermal thickening in front forms the *apical plate* from which the supra-oesophageal ganglion is derived, and a second thickening behind the mouth on the ventral surface subsequently gives origin to the infra-oesophageal ganglion. Meanwhile the coelome originates in a pair of sacs (Fig. 302, *pv*), or a single sac subsequently dividing into two—the *coelomic pouches*—growing out from the archenteron, and eventually becoming completely closed off from it to give rise to the coelome, which is thus of the enterocœle-type as regards its derivation. A groove, the *mantle-groove*, running transversely divides the embryo into two regions, a broad anterior and a narrower posterior. Folds which are formed in front of the mantle-groove are the beginnings of the dorsal and ventral mantle-lobes. A groove which appears in front of these separates off a head segment from the rest, and the embryo is now superficially divided into three segments or regions—*head region*, *body- or mantle-region* and *foot- or peduncle-region* (Fig. 303). The mantle-lobes increase in size and grow backwards over the peduncular region: in them are developed four groups of *provisional setae* which project backwards (Fig. 303): in *Cistella*, in which there are no setae in the adult, these are thrown off subsequently: in the genera in which setae are present in the adult they are also thrown off, but are replaced later by the permanent setae. The head-region has in the meantime become broadened out and in *Cistella* soon assumes the form of an umbrella-shaped disc bordered with cilia and usually bearing eye-spots (Fig. 304, *A*), and sometimes an apical tuft of long cilia. In this condition the

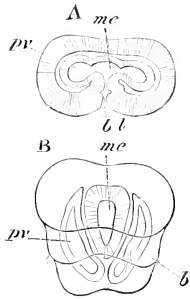

FIG. 302.—Two stages in the development of *Cistella* (*Argiope*). *b*, provisional setae; *bl*, blastopore; *mc*, mesenteron; *pv*, coelomic pouches. (From Baltour's *Embryology*, after Kowalevsky.)

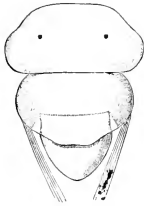

FIG. 303.—Young larva of *Cistella*, with the three segments, two eye-spots, and two bundles of setae. (From the *Cambridge Natural History*, after Kowalevsky.)

increase in size and grow backwards over the peduncular region: in them are developed four groups of *provisional setae* which project backwards (Fig. 303): in *Cistella*, in which there are no setae in the adult, these are thrown off subsequently: in the genera in which setae are present in the adult they are also thrown off, but are replaced later by the permanent setae. The head-region has in the meantime become broadened out and in *Cistella* soon assumes the form of an umbrella-shaped disc bordered with cilia and usually bearing eye-spots (Fig. 304, *A*), and sometimes an apical tuft of long cilia. In this condition the

larva swims freely like a trochophore. After a time it comes to rest and fixes itself by the peduncular segment. The mantle-folds become reflexed so as to point forwards instead of backwards, thus leaving the peduncular region exposed and covering the head-region (Fig. 304, *B*). The umbrella-like head-region decreases in size, and perhaps forms the lip, which is at first confined to the part immediately dorsal to the mouth. The lophophore appears at

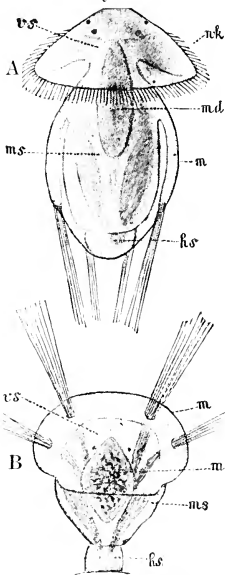

FIG. 304.—Two later stages in the development of *Cistella*. *A*, free-swimming; *B*, after fixation. *fs.*, peduncular region; *m*, mantle; *ms.*, body-region; *md.*, mesenteron; *wt.*, ciliated ring; *vs.*, head-region. (From Lang's *Comparative Anatomy*, after Kowalevsky.)

first on the inner surface of the dorsal mantle-lobe, but gradually extends and surrounds the mouth; in its earlier stages it is circular, but afterwards assumes the horse-shoe form by sending out paired extensions. In genera with a complex lophophore, like *Magellania*, this organ has at first a simple horse-shoe form (Fig. 305, *lph*). A shell is secreted by the mantle-lobes, and the peduncular region becomes the peduncle of the adult.

The development of *Lingula* (Inarticulata) differs somewhat widely from that of the Articulata. There is no division by definite constrictions into three regions. The head-region does not expand to the same extent: it early develops elevations which are the rudiments of the first-formed tentacles. The ridge from which the mantle-lobes are developed grows forwards from the outset. The coelome is not formed by outgrowth from the archenteron, but appears as a pair of cavities in a pair of masses of mesoderm-cells which are at first solid proliferations from the wall of the latter: in other words the coelome is not formed as an enterocoele but as a schizocoele.

Distribution.—The Brachiopoda are all marine. They are widely distributed geographically, and live at various depths—from between tide-marks to 2,900 fathoms. At the present day the class includes only about 20 genera and 100 species, but in past times the case was very different. Brachiopods appear first in the lower Cambrian rocks, where the existing genera *Lingula* and *Discina* are found. No more striking examples can be adduced of persistent types—organisms which have existed almost unchanged for the vast period during which the whole of the fossiliferous rocks have been in process of for-

mation. Altogether 106 genera are known from the Paleozoic rocks, 34 from the Mesozoic, and 21 in the Cainozoic and Recent periods. Obviously the group is tending, though slowly, towards extinction.

Researches on fossil and recent forms have shown the Brachiopoda to illustrate, in a remarkable manner, the recapitulation theory already referred to: the theory, that is, that ontogeny or individual development is a more or less modified recapitulation of phylogeny or ancestral development. It has been shown that there is a striking and almost complete parallelism between the stages in the development of the shelly loop in such highly organised forms as *Magellania*, and the entire series of articulated Brachiopods from those with the simplest to those with the most complex loop.

MUTUAL RELATIONSHIPS OF THE CLASSES OF THE MOLLUSCOIDA.

In adult structure *Phoronis* exhibits marked resemblances to the Ectoprocta, more especially to the *Phylactolamata*

—resemblances which will be rendered clear by a comparison of the diagrams *A* and *B* in Fig. 306. In both, the ventral side of the body is greatly produced and elongated, and, by the approximation of the mouth and anus, the dorsal surface is reduced to a very short space between those two apertures. The form of the lophophore, the presence of an epistome having similar relationships in the two groups, and the fact that the coelome is similarly developed in both, point in the same direction. Some points which are supposed to indicate relationships with the Annulata (*Sipunculoidea*) and with the Chordata are referred to at a later stage.

The resemblances between the Brachiopoda and the other two classes of the phylum are somewhat disguised by the development of the shell, but are very obvious—more particularly when we take into account certain features of the development. One of the most striking points of resemblance between the three classes is the presence of the lophophore with its tentacles; in the earlier stages of its development in the Brachiopod, as we have seen, this structure (Fig. 305) has the horse-shoe shape which it retains in the adult *Phoronida* and *Phylactolamata*, and a lobe—the arm-fold or lip (*lp*)—comparable to the epistome, is present overhanging the mouth. The end of the body of the Brachiopod with which the peduncle is connected must correspond to the aboral extremity

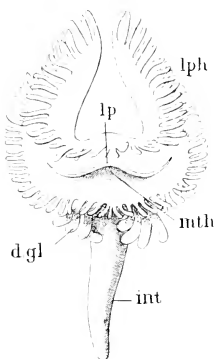

FIG. 305.—Lophophore of embryo of *Terebratulina*. *d. gl.* digestive gland; *int.* intestine; *lp.* lip; *lph.* lophophore; *nth.* mouth. (From Korschelt and Heider, after Morse.)

in the Polyzoa, since this represents the part by which the larval Polyzoan becomes fixed, the everted "sucker" of the latter being evidently homologous with the foot-segment of the larval Brachiopod. The end of the body of the Brachiopod from which the peduncle proceeds is thus the ventral portion. From the position of the epistome and lophophore, it follows that the dorsal valve of the Brachiopod, being on the same side of the mouth as the

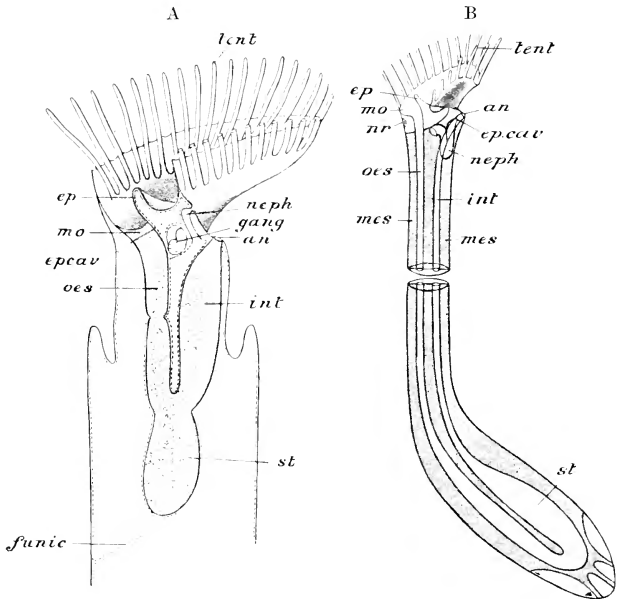

FIG. 306.—A, Diagrammatic median section of a phylactolematous **Polyzoan**. *an*, anus; *ep*, epistome; *ep. cav.*, epistome-cavity; *funic.*, funiculus; *gang.*, ganglion; *int.*, intestine; *mo.*, mouth; *neph.*, nephridium; *oes.*, oesophagus; *st.*, stomach; *tent.*, tentacles. B, diagrammatic median section of **Phoronis**. *mes.*, mesentery; *nr.*, nerve-ring. Other letters as in A. (From Korschelt and Heider, after Cori.)

epistome, lies on the side of the body corresponding with the anal side of the Polyzoan, though the intestine is bent round in the opposite direction and directed towards the ventral valve. The supra-oesophageal ganglion of the Brachiopod represents the single ganglion of the Polyzoa, though it is subordinate in importance to the infra-oesophageal ganglion—not represented in the latter group. Other important points of resemblance between the Brachiopoda and the Phoronida are seen in the character of the nephridia and

the presence in both of larval forms which may very well be looked upon as modified trochophores.

The setæ of Brachiopods, sunk in muscular sacs, are marks of annulate affinities, since such organs are found elsewhere only among Chaetopoda and Gephyrea (Sect. X.). The form of the larva tells in the same direction, the eye-bearing head region or prostomium and the provisional setæ being very striking characters. But the segmentation of the Brachiopod is quite different from that of the annulate larva, in which new segments are always added behind those previously formed, and in which metamerism always affects the mesoderm.

SECTION IX

PHYLUM ECHINODERMATA

THE phylum *Echinodermata* comprises the Starfishes (*Asteroidea*), Sea-urchins (*Echinoidea*), Brittle-stars (*Ophiuroidea*), Feather-stars (*Crinoidea*), and Sea-cucumbers (*Holothuroidea*). All exhibit a radial arrangement of parts, which is recognisable as well in the globular Sea-urchins and elongated Sea-cucumbers as in the star-shaped Starfishes, Brittle-stars and Feather-stars. Another universal feature is the presence of a calcareous exoskeleton, sometimes in the form of definitely shaped plates, which may fit together by their edges so as to form a continuous shell; sometimes merely in the form of scattered particles or spicules. In very many the surface is beset with tubercles or spines, from which feature the name of the phylum is derived. The various systems of organs attain a comparatively high degree of complexity. An extensive coelome is present, developed in the embryo from hollow outgrowths from the archenteron. The Echinoderms are rarely capable of rapid locomotion, and are sometimes permanently fixed by means of a stalk; they never give rise to colonies by budding. With hardly a single exception, all the members of this phylum are inhabitants of the sea.

1. EXAMPLE OF THE ASTEROIDEA.

A Starfish (*Asterias rubens* or *Anthenca flavescens*).

General External Features of *Asterias rubens*.—The body of the Starfish is enclosed in a tough, hard integument, containing numerous plates, or *ossicles* as they are termed, of calcareous material. This exoskeleton is not completely rigid in the fresh condition, but presents a certain limited degree of flexibility. The body (Fig. 307) is star-shaped, consisting of a central part, the *central disc*, and five symmetrically arranged processes, the *arms* or *rays*, which, broad at the base, taper slightly towards their outer extremities. There are two surfaces—one, the *aboral* or *abactinal*, directed upwards in the natural position of the living

animal; the other, the *oral* or *actinal*, directed downwards. The aboral surface is convex, the oral flat; the colour of the former is much darker than that of the latter.

In the centre of the oral surface (Fig. 307) is a five-rayed aperture, the *actinostome*, and running out from this in a radiating manner are five narrow grooves, the *ambulacral grooves*, each extending along the middle of the oral surface of one of the arms to its extremity. Bordering each of the ambulacral grooves there are either two or three rows of movable calcareous spines, the *ambulacral spines*. At the central ends of the grooves the ambulacral spines of contiguous sides of adjacent grooves form five groups, the *mouth papillæ*, one at each angle of the mouth. External to the ambulacral spines are three rows of stout spines which are not movable; and a third series runs along the border separating the oral from the aboral surface.

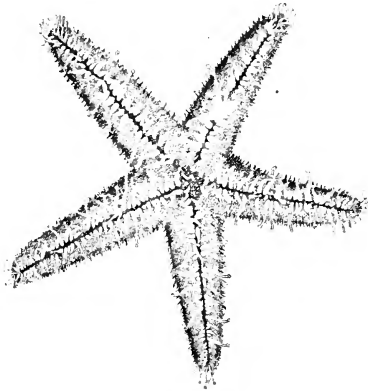

FIG. 307.—**Starfish** (*Asterias rubens*). General view of the oral or actinal surface, showing the tube-feet. (From Leuckart and Nitsche's Diagrams.)

On the convex aboral surface there are a number of short stout spines arranged in irregular rows parallel with the long axes of the rays. These are supported on irregularly-shaped ossicles buried in the integument. In the soft interspaces between the ossicles are a number of minute pores, the *dermal pores*, scarcely visible without the aid of a lens. Through each of these pores projects a very small, soft, filiform process, one of the *dermal branchiæ* or *papulæ* (Fig. 310, *Resp. cæ*), which is capable of being entirely retracted.

Very nearly, though not quite, in the centre of the aboral surface is an aperture, the *anus* (Fig. 315), wide enough to admit of the passage of a moderately stout pin. On the same surface, midway between the bases of two of the rays, is a flat, nearly circular plate, the surface of which is marked by a number of radiating, narrow, straight, or slightly wavy grooves; this is the *madreporite* (*mad.*). The presence of this structure interferes to some extent with the radial symmetry of the Starfish, two of the anti-meres (p. 42), viz. those between which the madreporite is placed,

being different from the rest. There thus arises a *bilateral* symmetry, there being one vertical plane, and only one—that passing through the middle of the madreporite and through the middle of the opposite arm—along which it is possible to divide the Starfish into two equal—right and left—portions.¹ The two rays between which the madreporite lies are termed the *bivium*, the three remaining the *trivium*.

Attached to the spines of the oral surface, in the intervals between them, and in the intervals between the spines of the dorsal surface, are a number of very small, almost microscopic bodies, which are termed the *pedicellariæ* (Fig. 310, *Ped*). Each of these is supported on a longer or shorter flexible stalk, and consists of three calcareous pieces—a *basilar* piece at the extremity of the stalk, and two *jaws*, which are movably articulated with the basilar piece, and are capable of being moved by certain sets of muscular fibres so as to open and close on one another like the jaws of a bird. In some of the *pedicellariæ* the jaws, when closed, meet throughout their entire length, while in the case of others, mostly arranged in circles round the spines on the aboral surface, one jaw crosses the other at the end like the mandibles of a Crossbill. Such *pedicellariæ*, with three calcareous pieces, are termed *forcipulate*.

In a well-preserved specimen there will be seen in each of the ambulacral grooves two double rows of soft tubular bodies ending in sucker-like extremities; these are the *tube-feet* or *podia* (Fig. 307). In a living specimen they are found to act as the locomotive organs of the animal. They are capable of being greatly extended, and when the Starfish is moving along, it will be observed to do so by the tube-feet being extended outwards and forwards (*i.e.* in the direction in which the animal is moving), their extremities becoming fixed by the suckers, and then the whole tube-foot contracting so as to draw the body forwards; the hold of the sucker then becomes relaxed, the tube-foot is stretched forwards again, and so on. The action of all the tube-feet, extending and contracting in this way, results in the steady progress of the Starfish over the surface. With the aid of the tube-feet the Starfish is also able to right itself if it is turned over on its back.

At the extremity of each of the ambulacral grooves is to be distinguished a small bright red speck, the *eye* (Fig. 310, *A*, *oc*), over which is a median process, the *tentacle* (*t*), similar to the tube-feet, but smaller and without the terminal sucker. The tentacles have been ascertained by experiment to be olfactory organs, the Starfish being guided to its food much more by this means than by the sense of sight.

Transverse Section of an Arm.—If one of the arms be cut across transversely (Fig. 308 and Fig. 310, *B*) and the cut surface

¹The slightly eccentric position of the anal aperture introduces a correspondingly slight inequality between the right and left portions.

examined, the aboral part of the thick, hard wall of the arm will present the appearance of an arch (with its convexity upwards), and the oral part the form of an inverted V, the ends of the limbs of which are connected with the oral ends of the aboral arch by a very short, flat, horizontal portion. Enclosed by these parts is a space, a part of the *cælome* or *body-cavity*, and below, between the two limbs of the V, is the ambulacral groove. The aboral arch is supported by a number of irregular ossicles and is perforated by the numerous small dermal pores, through which the dermal branchiæ project.

The V-shaped oral part of the body-wall—*i.e.* the walls of the ambulacral groove—is supported by two rows of elongated ossicles, the *ambulacral ossicles* (Fig. 310, *Amb.os*), which meet together at the apex or summit of the groove like the rafters supporting the roof of a house, but with a movable articulation allowing of separation or approximation of the two rows so as to open or close the groove. At the end of the ray the ambulacral ossicles end in a median *terminal* ossicle. At the

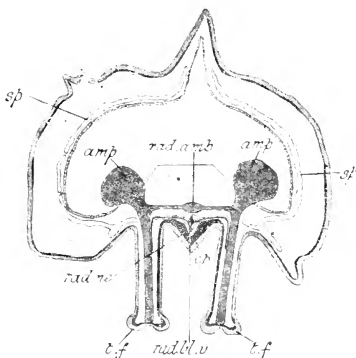

FIG. 308.—**Starfish.** Vertical section through an arm. *amp.* ampullæ; *ep.* epidermis; *rad. amb.* radial vessel of the ambulacral system; *rad. bl. v.* points to the septum dividing the perihæmal vessel into two parts; *rad. ne.* radial nerve of the epidermal system; *sp.* spaces in mesoderm of body-wall; *t. f.* tube-feet. (From Leuckart, after Hamann.)

edges of the groove a row of ossicles support the ambulacra spines and prominent tubercles. Between the ambulacral ossicles of each row are a series of oval openings, the *ambulacral pores*, one between each pair of contiguous ossicles, and so arranged that they form two rows on each side, one row higher than the other, the pores of the higher row alternating with those of the lower. In the ventral groove lie the contracted tube-feet (*T. F.*): each tube-foot is found to correspond to one of the ambulacral pores, so that the former, like the latter, are arranged in a double alternating row on each side of the groove. When the tube-foot is drawn upon, it is seen to be continuous with one of a series of little bladder-like bodies, which lie on the other side of the ambulacral ossicles, *i.e.* in the cavity of the arm. These—the *ampullæ* (Figs. 308 and 310, *amp.*)—are arranged like the tube-feet, in a double row on each side, a higher row and a lower, there being one opposite each ambulacral pore. When one of them is squeezed,

the corresponding tube-foot is distended and protruded, the cavities of the tube-foot and ampulla being in communication by means of a narrow canal running through the ambulacral pore and provided with a valve. It is in this way that the foot is protruded in the living animal: the corresponding ampulla being contracted by the contraction of the muscular fibres in its walls, the contained fluid is injected into the tube-foot and causes its protrusion, the return of the water backwards through the canal being prevented by the closing of the valve.

Vascular and Nervous Systems.—Running along the ambulacral groove, immediately below where the ambulacral ossicles of opposite sides articulate, is a fine tube, the *radial ambulacral vessel* (Fig. 308, *rad. amb*), which appears in the transverse section as a small rounded aperture. From this short side-branches pass out on either side to open into the bases of the tube-feet. Below the radial ambulacral vessel is a median thickening of the integument covering the ambulacral groove: this marks the position of the *radial nerve* (Fig. 308, *rad. ne*) of the *epidermal nervous system*, and is traceable as a narrow thickened band running throughout the length of the groove, and terminating in the eye at its extremity, while internally it becomes continuous with one of the angles of a pentagonal thickening of a similar character, the *nerve-pentagon*, which surrounds the mouth. In thin sections (Fig. 309) the ventral median thickening, or *radial nerve* (*rad. nerv.*), as well as the nerve-pentagon, are seen to be thickenings of the epidermis, consisting of numerous vertically-placed, fibre-like cells, with their nuclei at their outer (lower) ends, intermixed with longitudinal nerve-fibres and with nerve-cells. Above this, on each side of the epidermal nerve-thickening constituting the radial nerve, is a band of cells (*d. nerv.*) also of a nervous character. These more deeply placed nerve-bands are the radial parts of the *deep nervous system*: like the epidermal, the deep nervous system has a central part in the form of a pentagon, which in this case is double, surrounding the mouth. A third set of nerve elements (the *aboral* or *calomic nervous system*) extends along the roof of the arm superficial to the muscles.

The two radial nerve-bands of the deep nervous system are thickenings of the lining membrane of a space overlying the radial nerve and underlying the radial ambulacral system. This space (*rad. bl. v.*), extending, like the other parts that have been mentioned, throughout the length of the arm, forms part of a system of channels, the *perihæmal system*, which have been regarded as constituting a blood-vascular system. This *radial perihæmal vessel* or *sinus*, as it is termed, is divided longitudinally by a vertical septum (*sept.*) into two lateral halves. Internally it communicates with an *oral ring-vessel* surrounding the mouth and likewise divided into two by a septum. The inner division

of the ring-vessel is connected with the *axial sinus* referred to on p. 378.

In the septum dividing the radial perihæmal sinus into two runs a strand of a kind of gelatinous connective tissue containing many leucocytes and perforated by irregular channels or *lacunæ*: this is the radial strand of the *lacunar* or *hæmal system*. Like the radial vessels of the perihæmal system, the radial strands of the lacunar system are connected internally with an oral ring.

Structure of the Disc.

—When the aboral wall of the central disc is dissected away, the remainder of the organs come into view (see Fig. 313). The rows of ambulacral ossicles appear in this view as ridges, the *ambulacral ridges*, one running along the middle of the oral surface of each arm to its extremity, and extending inwards to the corresponding angle of the mouth. At the sides of each of these ridges appear the rows of ampullæ. Within the pentagonal actinostome is a space, the *peristome*, covered with a soft integument, and in the centre of this is a circular opening, the true *mouth*, the size of which is capable of being greatly increased or diminished.

Body-wall and Cœlome.—The entire outer surface is covered with a layer of ciliated epithelium, the *epidermis* or *deric epithelium* (Fig. 310, *Der Epithm*), which is continued over the various appendages and processes—the tubercles and spines, the pedicellariæ, the dermal branchiæ, and the tube-feet. Beneath it is a network of nerve-fibrils with occasional nerve-cells. The *mesoderm* (*Derm*) of the wall of the body beneath this consists of two layers, between which are a number of spaces: the ossicles (*os*) are all, except the ambulacral ossicles and the inter-radial partitions, developed in the outer of these two layers. Each *ossicle* consists of a close network of calcareous rods. Between contiguous ossicles extend bands of muscular fibres.

The interior of the *cœlome* (*Cæl.*) or body-cavity is lined by a ciliated epithelium, the *cœlomic epithelium* (*Cæl. Epithm.*), which not only covers the inner surface of the body-wall as the *parietal layer*, but also forms an investment for the contained organs—the various parts of the alimentary canal and its appendages, the gonads, the madreporic canal, ampullæ, etc. In addition

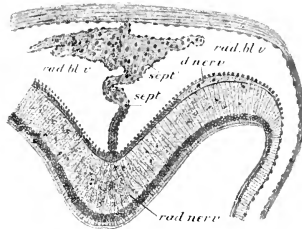

FIG. 309.—**Starfish.** Lower part of a vertical section through the arm, to show the structure of the radial nerve and the position of the deep nervous system and radial perihæmal vessels. *d. nerv.* strand of deep nervous system; *rad. bl. v.* radial perihæmal vessel; *rad. nerv.* radial nerve; *sept.* septum of radial perihæmal vessel; *septl.* radial lacunar strand of the hæmal system (here represented as solid). (After Cuvénot.)

to this *visceral layer* of the peritoneum, the wall of the alimentary canal and its cæca consists of a *muscular layer* and an internal lining, the *enteric epithelium* or *endoderm* (*Ent. Epithm.*). The cœlome is filled with a fluid, the *cœlomic fluid*, consisting mainly of sea-water, but containing a number of amœboid corpuscles (*amœbocytes*). These collect particles of waste-matters, and when loaded with them pass to the exterior by traversing the walls of the papulæ. The latter consist of a *muscular layer*, an *external epidermal layer*, and an *internal peritoneal layer*,

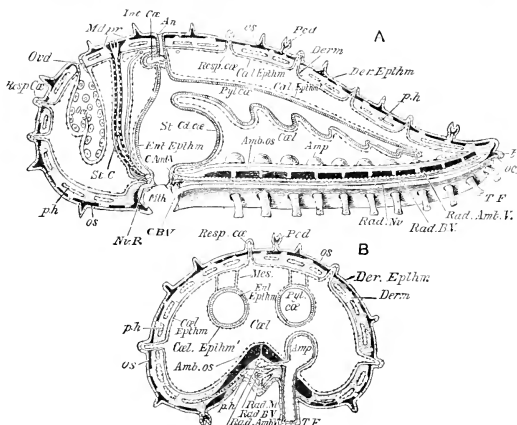

FIG. 310.—Diagrammatic sections of a **Starfish**. **A**, vertical section passing on the right through a radius, on the left through an inter-radius. The off-side of the ambulacral groove with the tube-feet (*T. F.*) and ampullæ (*Amp.*) are shown in perspective. **B**, transverse section through an arm. The ectoderm is coarsely dotted, the nervous system finely dotted, the ectoderm radially striated, the mesoderm evenly shaded, the ossicles of the skeleton black, and the cœlomic epithelium represented by a beaded line. *Amb. os.*, ambulacral ossicles; *Amp.*, ampullæ; *An.*, anus; *C. Amb. V.*, circular ambulacral vessel; *C. B. V.*, septum of ring perihæmal vessel; *Cl. cæ.*, cardiac cæca; *Cal. cœlome*; *Cal. Epithm.*, cœlomic epithelium; *Der. Epithm.*, deric epithelium; *Derna*, mesoderm; *Ent. Epithm.*, enteric epithelium; *Int. cæ.*, intestinal cæca; *Md. pr.*, madreporite; *Mes.*, mesentery; *Mth.*, mouth; *Nv. R.*, nerve-ring; *oc.*, eye; *os.*, ossicles of body-wall; *Ord.*, oviduct; *Ped.*, pedicellariæ; *ph.*, perihæmal spaces; *Pyl. cæc.*, pyloric cæca; *Rad. amb. v.*, radial ambulacral vessel; *Rad. B. V.*, points to septum in the radial perihæmal vessel; *Rad. Nv.*, radial nerve; *Resp. cæ.*, dermal branchiæ; *St.*, stomach; *St. c.*, stone-canal; *t.*, tentacle; *T. F.*, tube-feet. (From Parker's *Biology*.)

the internal cavities being in free communication with the cœlome.

Digestive System.—The mouth is found to open through a short passage, the *œsophagus*, into a wide sac, the *cardiac division of the stomach* (Fig. 310, *St.*, Figs. 313, 315, *card. st.*). This is a five-lobed sac, each of the lobes of which is opposite one of the five arms. The walls of the sac are greatly folded, and the whole is capable of being everted through the opening of the mouth, by contraction of the muscular fibres of the body-wall, wrapped over

some object desired as food, and then retracted into the interior, the retraction being effected by means of special *retractor* muscles (Fig. 313, *retr*) which arise from the sides of the ambulacral ridges. This cardiac division of the stomach communicates aborally with a much smaller chamber, the *pyloric division of the stomach*, and this in turn opens into a very short conical *intestine*, which leads directly upwards to open at the anal aperture. The pyloric division of the stomach is pentagonal, each angle being drawn out to form a pair of large appendages, the *pyloric cæca* (Figs. 310, 311, 313, 315, *pyl. cæc*). Each pair of pyloric cæca commences as a cylindrical canal or *duct*, the lumen of which is continuous with the cavity of the pyloric chamber. This soon bifurcates to form two hollow stems, extending to near the extremity of the cavity of the arm, and giving off laterally two series of short branches, each having connected with it a number of small bladder-like pouches. The walls of the pyloric cæca are glandular: they secrete a digestive fluid, and are therefore to be looked upon as *digestive glands*. It is

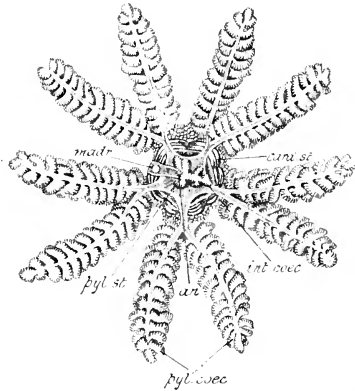

FIG. 311.—*Asterias rubens*. Digestive system. *an.* anus; *card. st.* cardiac division of the stomach; *int. cæc.* intestinal cæca; *madr.* madreporite; *pyl. cæc.* pyloric cæca; *pyl. st.* pyloric division of the stomach. (From Leuckart.)

found by experimenting with this digestive fluid that it has an action on food-matters similar to that exerted by the secretion of the pancreas in the Vertebrata, converting starch into sugar, proteids into peptones, and bringing about the emulsification of fats. While the pouches of the cardiac division of the stomach are attached to the oral wall of the body, the pyloric cæca are connected with the aboral wall. From the short intestine are given off inter-

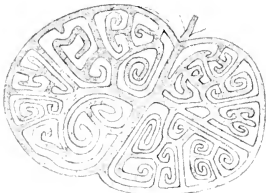

FIG. 312.—Transverse section through the madreporic canal of a *Starfish* (*Astropecten*). (From Gegenbaur, after Teuscher.)

radially two hollow appendages, the *intestinal cæca* (Figs. 311 and 313, *int. cæc*), each with several short branches of irregular shape.

Ambulacral System.—Running downwards from the madre-

porite to near the border of the mouth is an S-shaped cylinder, the *madreporic* or *stone-canal* (Fig. 315, *mad. can*). The walls of this canal are supported by a series of calcareous rings, and projecting into it is a ridge which bifurcates to form two spirally rolled lamellæ occupying a considerable part of the lumen of the canal. In some Starfishes, such as *Astropecten* (Fig. 312), the internal

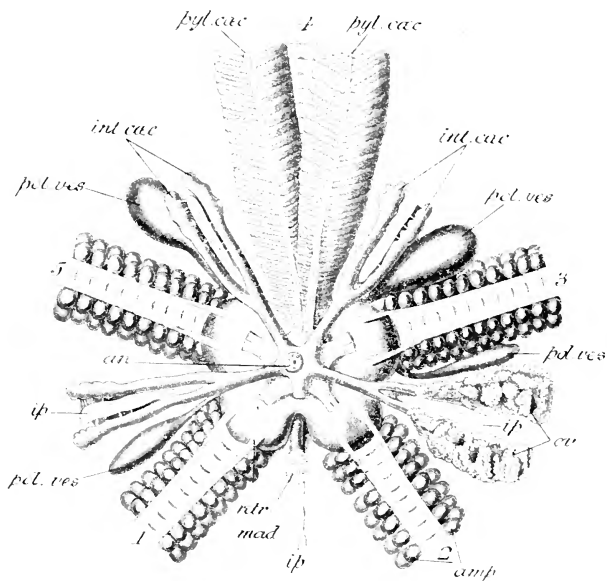

FIG. 313.—*Anthenea flavescens*. Upper view of a dissection of the internal organs. The aboral wall of the body, with the exception of a small portion round the anus and the madreporite, has been completely removed. One of the five intestinal caeca has been removed with the exception of its proximal part. All the ovaries have been removed except one pair, and four of the pairs of pyloric caeca have been cut away close to their bases. 1—5, the five rays with their ambulacral ridges; *amp.* ampullae; *an.* anus; *int. cac.* intestinal caeca; *i. p.* cut ends of the inter-radial partitions; *mad.* madreporite with the madreporic canal; *ov.* ovaries; *pol. ves.* Polian vesicles; *pyl. cac.* pyloric caeca; *retr.* retractor muscles inserted into the cardiac division of the stomach.

structure is more complicated owing to the branching of the lamellæ. The interior of the madreporic canal communicates above with the exterior through the grooves of the madreporite. At the bottom of each of the grooves are a number of fine pores leading into vertical canals of corresponding fineness, all lined, like the grooves and the madreporic canal itself, with long cilia: most of these open below into a dilatation of the madreporic canal, some into the axial sinus referred to below. Below, the madreporic canal opens into a

wide, five-sided, ring-like canal, the *ring-vessel of the ambulacral system*. From this are given off the five radial ambulacral vessels, passing to the extremities of the arms. From the pentagonal canal are given off also in most Starfishes, but not in *Asterias*, a series of five pairs of appendages, the *Polian vesicles* (Fig. 313, *pol. ves.*)—pear-shaped, thin-walled bladders with long narrow necks—which are placed inter-radially. At the sides of the neck of each Polian

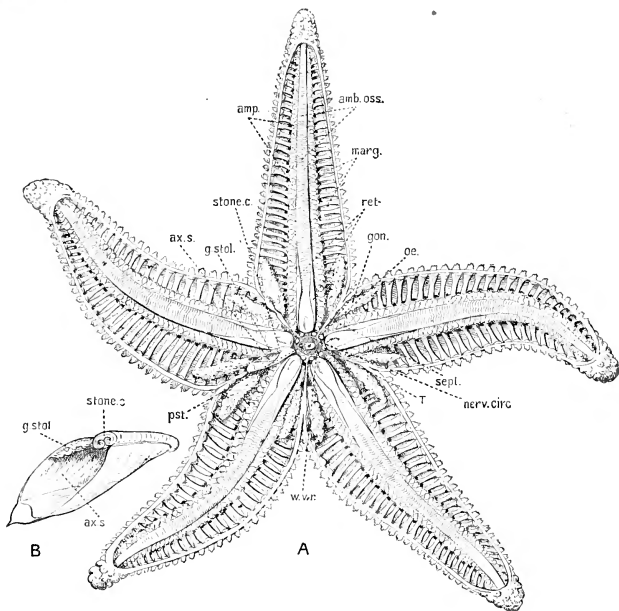

FIG. 314.—A, view of the under part of a specimen of *Asterias rubens*, which has been horizontally divided into two nearly equal portions. B, enlarged view of the axial sinus, stone-canal and genital stolon cut across. *amb. oss.*, ambulacral ossicle; *amp.*, ampulla of the tube-feet; *ax. s.*, axial sinus; *gon.*, gonad; *g. stol.*, genital stolon or axial organ; *marg.*, marginal ossicle; *nerv. circ.*, nerve-ring; *oe.*, cut end of oesophagus; *pst.*, peristome; *ret.*, retractor muscle of the stomach; *sept.*, inter-radial septum; *stone. c.*, stone-canal; *T.*, Tiedemann's vesicle; *w. v. r.*, water-vascular ring-canal. (After MacBride.)

vesicle (except in the inter-radius containing the madreporic canal, where there is one on one side only) project inwards a pair of little rounded glandular bodies, the *racemose* or *Tiedemann's vesicles* (Fig. 314, *T*), the cavity in the interior of each of which, opening into the ring-vessel, is divided into a number of chambers.

The various parts of the ambulacral system of vessels have a muscular wall and an internal lining epithelium in addition to the

coverings which they may derive, according to their situation, either from the external epidermis or the internal cœlomic epithelium. The muscular layer is most strongly developed on the tube-feet, where it consists of two strata, and is also well developed on the ampullæ and Polian vesicles.

The stone-canal is enfolded in the wall of a wider canal, the *axial sinus* (Fig. 314, *ax. s.*), which forms a part of the perihæmal system already referred to. The axial sinus runs nearly vertically. At its oral end it opens into the internal division of the oral ring sinus; aborally it approaches close to, if it does not actually open into, an *aboral ring sinus*: it also communicates aborally with the stone-canal, and opens on the exterior through certain of the pores in the madreporite.

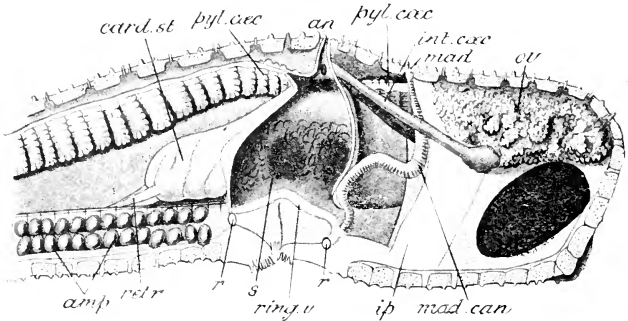

FIG. 315.—*Anthenea flavescens*. Lateral view of a dissection in which one of the rays and a portion of a second have been removed, and in which the alimentary canal has been laid open. *amp.* ampullæ; *an.* anus; *card. st.* cardiac pouch of the stomach; *int. cœc.* intestinal caecum; *ip.* inter-radial partition; *mad.* madreporite; *mad. can.* madreporic canal; *ov.* ovary; *pyl. cœc.* pyloric caeca; *r.* cut ends of the ring-vessel of the ambulacral system; *ring v.* position of the ring-vessel; *retr.* retractor muscle of cardiac pouch of stomach; *s.* cavity of the stomach.

Accompanying the madreporic canal and also enfolded in the wall of the axial sinus there is an organ—the *axial organ* (Fig. 314, *g. stol*)—the relationships and function of which have given rise to a considerable amount of difference of opinion. It is a fusiform body, the interior of which assumes an appearance of complexity largely due to both its inner surface (*i.e.*, that turned towards the axial sinus) and its outer (that facing the cœlome) being folded in a complicated manner. The axial organ contains strands of lacunar tissue, *i.e.* of the same tissue that composes the so-called hæmal system, and is intimately related with the latter. Its essential morphological character, however, appears to be that of a *genital stolon*. At its aboral end it is continuous with a *genital rachis*, which, in the form of a ring, runs in the aboral perihæmal sinus, and gives off branches to the gonads. There is

evidence that the sexual cells originate in the aboral end of the axial organ, and travel through the genital rachis and its branches to the gonads, which are to be looked upon as the greatly expanded extremities of the latter. Strands of the lacunar tissue accompany the genital rachis and its branches to the gonads.

Reproductive System.

—The Starfish is *unisexual*, each individual possessing either *ovaries* (Figs. 313, 314, and 315, *ov*) or *testes*, which appear very similar until they are examined microscopically. They consist of masses of rounded follicles, like bunches of minute grapes—a pair in each inter-radial interval. Ova and sperms are alike developed from cells of the same character as those which become the amœbocytes of the cœlomic and other cavities of the body.

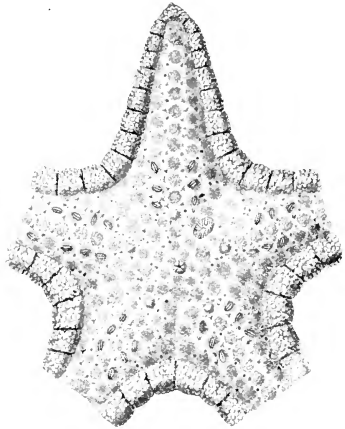

FIG. 316.—*Anthenea*, view of aboral surface, showing granular ossicles, madreporite and anus. (After Sladen.)

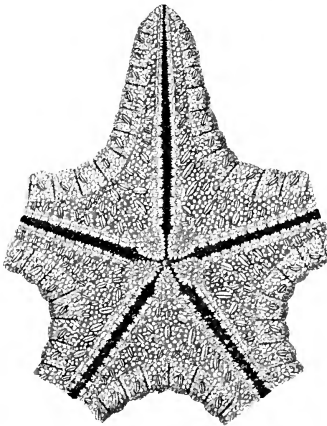

FIG. 317.—*Anthenea*, view of oral surface, showing ambulacral grooves with small ambulacral spines, mouth-papillae and valvate pedicellariae. (After Sladen.)

The ducts, by means of which the ova or sperms reach the exterior, open on the aboral surface through a number of perforations on a pair of sieve-like plates, situated interradially close to the bases of the arms.

Anthenea flavescens (Figs. 313, 315, 316, 317), a common Australian Starfish, which may be taken as an example instead of *Asterias rubens*, differs from the latter in the following main points.

The animal consists of a relatively large central disc and five relatively short arms, which taper rapidly towards their extremities. On the

oral surface the comparatively broad, flat surfaces between the ambulacral grooves are roughish, owing to the plate-like ossicles being beset with a number of minute rounded *tubercles* or *granules*, which, in the immediate neighbourhood of the ambulacral grooves, assume the character of short, blunt spines. Here and there among the tubercles, usually one in the middle of each ossicle, are *pedicellariæ*, which differ widely from those of *Asterias*. Each pedicellaria in *Anthenea* is a small, narrow, oblong, calcareous body, consisting of two parallel narrow valves or jaws: these, instead of being supported on a flexible stalk, are articulated with the edges of a slit-like depression on the surface of the flat ossicle, and are thus on a level with the general surface. The term *valvate* is applied to pedicellariæ of this description. In a living *Anthenea* many of the pedicellariæ will be found to have their valves widely open; when they are touched the valves close together, gradually opening again after a little time. The *ambulacral spines* bounding the ambulacral grooves are flattened and blunt, and arranged in fan-like fasciculi. Round the border separating the aboral and oral surfaces the plates are arranged in two somewhat irregular rows.

The aboral surface is strongly convex, but not uniformly so, there being a more or less distinct depression in the form of a shallow open groove, the *inter-radial depression*, opposite each of the intervals between the arms. The surface is dotted over with numerous small rounded *tubercles*, arranged in somewhat irregular radiating lines. These aboral tubercles, though fewer than those on the oral surface, are for the most part more prominent, so that they assume the character of short spines. The ossicles on which they are borne are star-shaped with six rays, a spine being borne in the centre of each ossicle, and one on each of the rays. Between the ossicles the surface is covered with a soft, slimy skin, perforated by a large number of minute dermal pores, each of which is enclosed by a minute irregular ring of calcareous matter; each pore serves for the lodgment of one of the dermal branchiæ. Numerous pedicellariæ, similar to those on the ventral surface, but smaller, are borne on the ossicles, usually taking the place normally occupied by the central spine. The *tube-feet* are arranged in a single row on each side of each ambulacral groove; but the *ampullæ* are in two rows, an upper and a lower, and each tube-foot has two ampullæ connected with it, one of the upper row and one of the lower row.

Anthenea has vertical calcareous *inter-radial partitions* not developed in *Asterias*. There are five bifid *intestinal cæca*, which are narrow tubes, slightly enlarged and lobed at the extremities.

Development of a Starfish (*Asterina gibbosa* or *A. exigua*).¹—In these Starfishes the reproductive apertures are

¹ The development of these has been described in preference to that of the examples, as it is more completely known.

placed on the ventral surface. When the ova have been discharged and impregnated, they adhere by means of a viscid investment to the surface (rock or stone) on which they are laid, and go through all the stages of their development in this position, never passing through a free pelagic stage. The eggs are about half a millimetre in diameter, and of a spherical shape. Each consists of a perfectly opaque central mass of yellow or orange yolk, and of a glassy layer enclosing this. After fertilisation the process of segmentation begins by the division of the ovum into two blastomeres almost equal in size, but one, which may be termed cell I., slightly smaller than the other (cell II.). Both I. and II. soon afterwards divide, I. somewhat earlier than II. The resulting

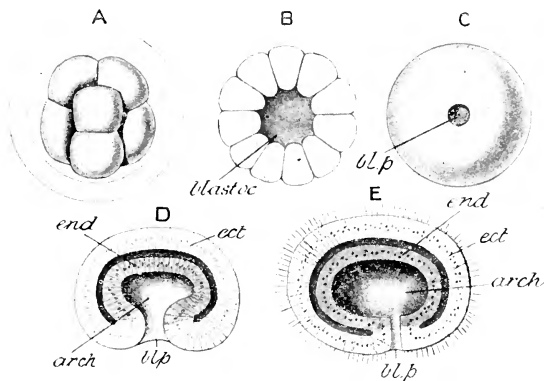

FIG. 318.—Early stages in the development of a Starfish (*Asterina gibbosa*). A, eight-celled stage; B, stage of about thirty-two cells seen in section; C, gastrula stage; D, section of early gastrula; E, section of later gastrula. arch, archenteron; blastoc, blastocoele; blp, blastopore; ect, ectoderm; end, endoderm. (Modified after Ludwig.)

four cells again divide, leading to the formation of an eight-celled stage (Fig. 318, A), in which the four cells derived from I. form an incomplete ring not closed below, and the four derived from II. form an incomplete ring open above.

The eight cells then divide by meridional fissures into sixteen, and a further division results in the formation of thirty-two. The thirty-two cells become arranged in such a way as to enclose a central cavity which had been present in the four-celled stage: this stage (B) is the *blastula*; the cavity is the *segmentation-cavity* or *blastocoele*. The number of cells in the wall of this cavity increases by further divisions, and the whole surface becomes covered with vibratile cilia. A process of *invagination* then follows, one side of the blastula being pushed inwards to form a double-walled cup or *gastrula* (C) opening on the exterior by

an opening, the *blastopore*, which, at first very wide, gradually becomes narrowed. At the same time the shape of the larva alters, so as to be somewhat elongated, the blastopore, lying at first midway between the two poles, afterwards gradually drawing nearer to what becomes the posterior end.

Of the two layers of the gastrula (*D* and *E*), the outer is the *ectoderm*, the inner the *endoderm*; between them is a space, at first filled with gelatinous matter, in which cells soon appear, giving rise subsequently to an intermediate mass of tissue, the *mesenchyme*.

The cavity in the gastrula is early distinguishable into two parts (Fig. 319, *B*)—that part into which the blastopore leads (*arch*), and a wider terminal part (*ent*); the former becomes the stomach and intestine of the larva, the blastopore giving rise to the

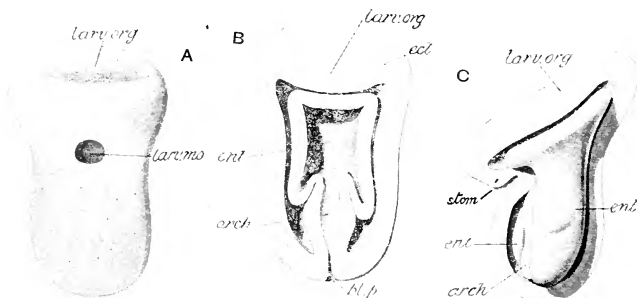

FIG. 319.—Later stages in the development of the larva of *Asterina gibbosa*. *A*, newly hatched larva, ventral surface, with the beginning of the larval organ at the anterior end and with the larval mouth. *B*, dorsal half of an embryo of the same age as *A*. *C*, somewhat older larva with larger larval organ, the ectoderm of the left side removed to expose the alimentary canal and the walls of the body-cavity. *arch*, archenteron; *bl. p.*, blastopore; *ect*, ectoderm; *ent*, enterocoele; *larv. mo.*, larval mouth; *larv. org.*, pre-oral lobe; *stom.*, stomodaeum. (From Ziegler's models.)

larval anus; the latter is termed the *enterocoele* (*coelome*). The wall of the enterocoele becomes thinner, and it gives off two lateral swellings, the right and left *enterocoealic pouches* (*C*, *ent*), which are closely applied to the sides of the larval alimentary canal: the left pouch is soon seen to be larger than the right. The enterocoele is subsequently completely closed off from the enteric canal. It now consists of three parts, an anterior undivided part, and the two pouches, right and left. Of the latter the left grows more rapidly than the right: both extend posteriorly in the space between the enteric canal and the body-wall to coalesce posteriorly in such a way as to give rise to the *coelome* of the adult. The anterior undivided part (*anterior coelome*) forms the *coelome* of a conspicuous larval structure, the pre-oral lobe, and it eventually becomes cut off from the right and left pouches, giving off on

the left a five-lobed outgrowth, the *hydrocœle*, which forms the foundation of the entire ambulacral system of the adult: a right hydrocœle is only represented by a small vesicle which in normal embryos undergoes no further development. Before the hydrocœle is developed and before the right and left cœlomic pouches have become cut off, two apertures make their appearance on the surface of the larva: one, on the ventral side, is the opening of the *stomodæum* or *larval mouth*; the other, on the dorsal side, is the *dorsal pore*. The mouth subsequently opens into the larval stomach, and for a time the enteric canal of the larva opens on the exterior both by mouth and anus: soon, however, the larval anus becomes closed up. The dorsal pore is developed as an outgrowth of the anterior part of the enterocœle, a little to the left of the middle line, meeting a thickening of the ectoderm about the middle of the dorsal surface, where an aperture is formed.

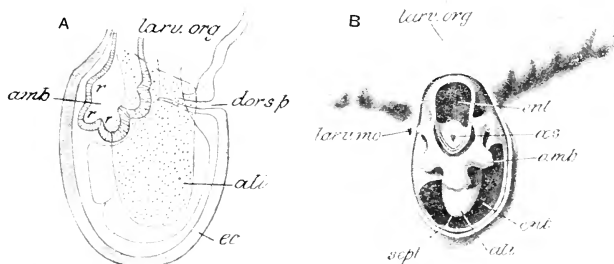

FIG. 320.—Larva of *Asterina gibbosa*. *A*, diagrammatic lateral view; the alimentary canal dotted, the ambulacral system striated, the ectoderm shaded. *B*, Larva seen from the left as an opaque object, the body-wall of the left side removed; hydrocœle separated off from left enteric sac and partly surrounding œsophagus. *ali*, alimentary canal; *amb*, ambulacral system or hydrocœle; *dors. p.*, dorsal pore; *ent*, enteric sacs and cœlome; *larv. mo.*, larval mouth; *larv. org.*, pre-oral lobe; *œs.*, œsophagus of adult; *r, r.*, lobes of hydrocœle; *sept.*, septum between the enterocœlic sacs. (*A*, after Ludwig; *B*, from Ziegler's models.)

The *pre-oral lobe* appears at an early stage as a dilatation at the anterior end of the larva. This takes a dorso-ventral direction, and assumes the character of an elongated, almost cylindrical, hollow appendage at the anterior end of the larva, consisting of a shorter ventral, and a longer dorsal, part. On the anterior surface of the pre-oral lobe a flattened area appears surrounded by a raised rim, which is beset with specially large cilia: this is the *larval organ*. In the middle of the larval organ appears an elevation, the rudiment of a sucker by means of which the larva becomes attached when the metamorphosis is about to begin. At this stage the larva (Fig. 321) is able to creep by contractions of the pre-oral lobe, and also by the action of the cilia, more especially the cilia of the larval organ.

The hydrocœle, at first a five-lobed outgrowth of the entero-

cœle, grows into the form of a horse-shoe with five lobes, each of which represents one of the radial parts of the ambulacral system, the horse-shoe itself representing the ring-vessel. The rudiment of the madreporic canal arises as a groove on the posterior wall of the anterior cœlome. This develops into a canal leading from the hydrocœle to the anterior cœlome, and eventually entering into connection with the dorsal pore, forms a tube, the madreporic canal, leading from the ring canal to the madreporite, of which the dorsal pore represents the first-formed aperture.

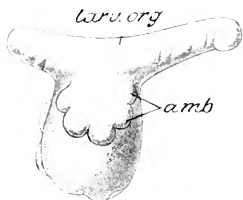

FIG. 321.—Larva of *Asterina*, view of the left side, showing the five-lobed prominence (*amb.*) formed by the developing ambulacral system on what is destined to become the ventral surface of the body of the Starfish; *lars. org.*, pre-oral lobe with larval organ.

hydrocœle. Each of the latter then becomes divided, first into three rounded processes (Fig. 320, *B*, *amb*), and then into five, and these project freely on the surface; the middle one is the rudiment of the tentacle, the lateral processes are the first two pairs of tube-feet. At the same time five elevations of the opposite wall become evident, and give rise to the beginnings of the dorsal regions of the arms (Fig. 323).

The transition from the larval stage to the condition of the five-rayed Starfish (Fig. 322) is effected by the absorption of the pre-oral lobe—which, on the larva becoming fixed by means of the sucker, degenerates into a temporary stalk and eventually becomes completely absorbed)—by the further development of the arms and tube-feet, and by certain changes which take place in the internal organs. Of these, one of the most important is the formation of

As the hydrocœle develops, its form influences the external shape of the larva; on the left-hand side there grows out a five-lobed elevation (Fig. 321, *amb*), each of the lobes corresponding to one of the five lobes of the

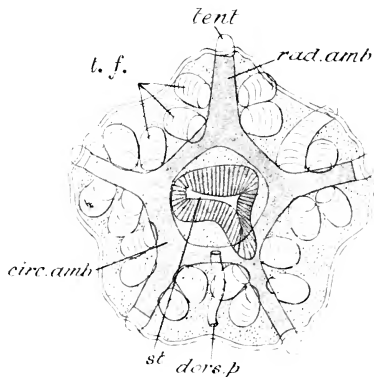

FIG. 322.—*Asterina exigua*. Young Starfish shortly after the metamorphosis has been completed, viewed from the oral side. *circ. amb.* circular ambulacral vessel; *dors. p.* dorsal pore and madreporic canal; *rad. amb.* radial ambulacral vessel; *st.* stomach; *tent.* tentacle; *t. f.* tube-feet.

a new mouth and œsophagus (Fig. 320, *B*, œs), the larval mouth and œsophagus becoming abolished during the metamorphosis. The new mouth is formed in the centre of the hydrocœle (ring-vessel). From the stomach, diverticula grow out radially into the developing

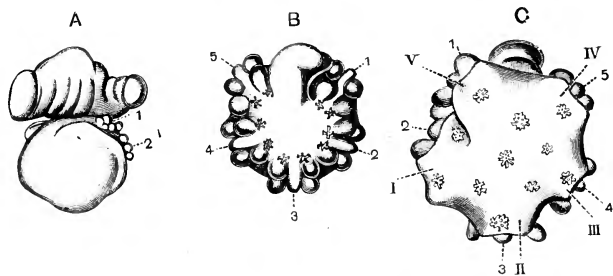

FIG. 323.—Views of the larva of *Asterina gibbosa* in the course of metamorphosis. *A*, larva of eight days, from the right; *B*, left, and *C*, right view of the larva of nine days; 1-5, lobes of hydrocœle; I-V, rudiments of arms. (From MacBride, after Ludwig.)

arms to give rise to the cœca; and later the permanent anal opening is formed on the dorsal surface.

When the first ossicles are definitely formed they present the following arrangement (Fig. 324). In the middle of the abactinal surface is a single

central plate (dors).

Around this are five *basals (bas)*

one of which becomes merged into the madreporite.

External to these, five *radials (rad)*

appear somewhat later. At the end

of each developing arm is a single

terminal or ocular plate (term), which

is carried outwards as the ambulacral

and adambulacral ossicles of the arm

are developed, supporting the

corresponding eye and tentacle. A ring of *secondary radials* or

infra-basals (sec. rad) is developed between the radials and the

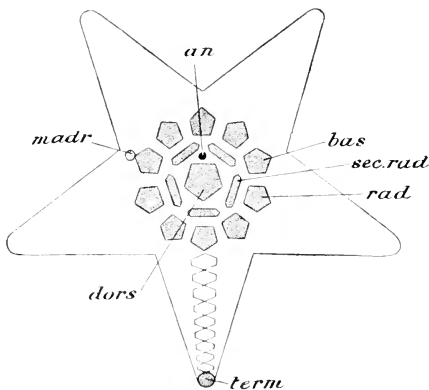

FIG. 324.—Diagram showing the relations of the chief plates of the apical system in the young *Starfish*. *an*, anus; *bas*, basals; *dors*, central; *madr*, madreporite; *rad*, radials; *sec. rad*, secondary radials (infra-basals); *term*, terminal.

central. In the adult, by the intercalary development of numerous additional ossicles, these primary plates of the *apical system*, as it is termed, lose their original arrangement, and become no longer recognisable.

2. EXAMPLE OF THE ECHINOIDEA.

A Sea-urchin.—(*Strongylocentrotus* or *Echinus*.)

General External Features.—The Sea-urchin (Figs. 326 and 327) is globular in shape, but somewhat compressed in one

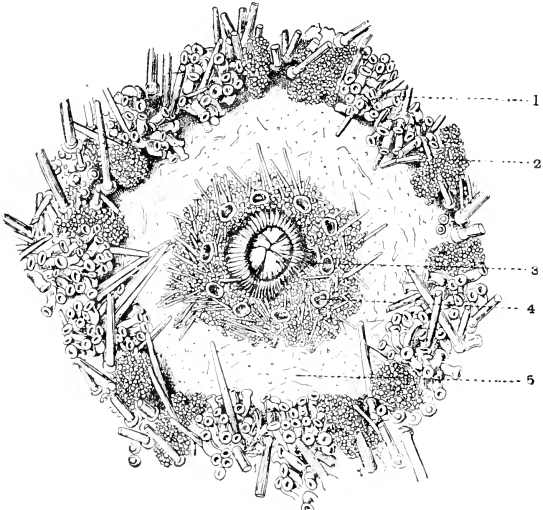

FIG. 325.—*Echinus esculentus*, peristome. 1, tube-feet of the lower ends of the radii; 2, branchia; 3, teeth; 4, oral tube-foot (tentacle); 5, peristomial membrane (From MacBride, after Kükenthal.)

direction, so that two *poles* are distinctly recognisable. At one of these the degree of flattening is greater than at the other; this is the *oral pole*, the opposite pole being termed the *anal* or *aboral*. At the oral pole is a rounded aperture, the *mouth*, through which may be seen projecting five hard white points, the extremities of the *teeth*, surrounding the mouth is a thin, soft membrane known as the *peristome* or *peristomial membrane* (Fig. 325). At the anal pole is a much smaller aperture, the *anus*, the space immediately surrounding which is termed the *periproct* (Fig. 327).

The entire surface, with the exception of the peristome and periproct, is bristling with spines—cylindrical, pointed, solid appen-

dages, the surface of which is longitudinally fluted. These are movably articulated with the body so that they may be turned about in all directions. When one of them is removed (see Fig. 343, p. 413), it is found that the joint is of the character of a ball and socket, a concavity on the base of the spine fitting over a hemispherical elevation on the surface of the Sea-urchin, and the spine being retained in place and caused to move by means of a capsule of muscular fibres enclosing the joint. Around the bases of the large spines are a number of very small spinules. Here and

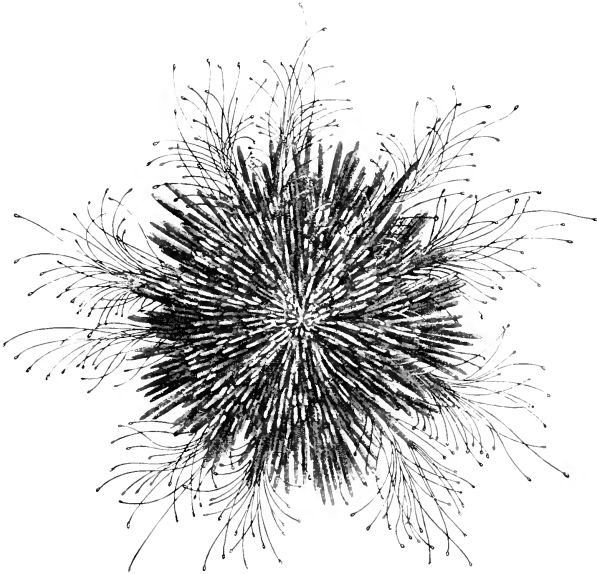

FIG. 326.—*Strongylocentrotus*, entire animal with the tube-feet extended. (From Brehm's *Tierleben*.)

there among the spines are to be observed minute *pedicellariæ* (see Fig. 344, p. 413), which are comparable to the stalked pedicellariæ of *Asterias*; but each has three jaws instead of two, and a relatively long stalk, which is supported by a slender calcareous rod. Here and there are to be found also small rounded bodies termed the *sphæridia*, which are perhaps, like the pedicellariæ, to be looked upon as modified spines: they contain ganglion-cells and are apparently organs of special sense, having possibly the function of detecting changes in the composition of the water.

Projecting from the surface among the spines all the way from the peristome to the periproct will be observed five double rows of *tube-feet* or *podia* (Fig. 326), which in a living specimen will be found to be capable of great extension. These are similar to the tube-feet of the Starfish, and have similar functions: the sucker-like extremity of each is supported by a plate of calcareous matter. Each double row of tube-feet occupies a meridional zone of the surface, termed the *ambulacral area*, corresponding to the ambulacral groove of the Starfish: the intermediate zones are termed the *inter-ambulacral areas*. At the oral end of each ambulacral area

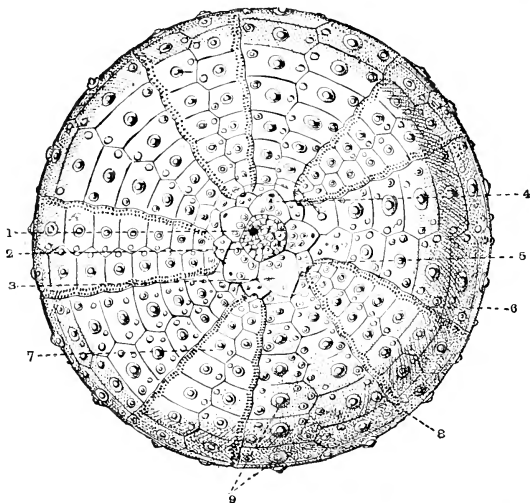

FIG. 327.—Corona of *Echinus esculentus*, from the aboral surface, showing the arrangement of the plates of the corona. 1, the anus; 2, periproct, with irregular plates; 3, the madreporite; 4, one of the other genital plates; 5, an ocular plate; 6, an inter-ambulacral plate; 7, an ambulacral plate; 8, pores for the protrusion of the tube-feet; 9, tubercles. (After MacBride.)

on the peristome (Fig. 325, 4) is a pair of appendages similar to tube-feet, but shorter, and termed *oral tentacles*. Ten shrub-like appendages, the *dermal branchiæ* (2), are situated in the peripheral part of the peristome, a pair opposite each inter-ambulacral area.

When the spines are removed, the body is found to be enclosed in a rigid globular shell, or *corona* (Fig. 327) as it is termed, formed of a system of plate-like ossicles, the edges of which fit accurately and firmly together, and the surfaces of which are ornamented with the rounded elevations or tubercles for the articulation of the spines. These plates are arranged in ten zones, each

consisting of two rows, running in a meridional direction from the edge of the peristome to the neighbourhood of the periproct. Of the zones of plates there are two sets, each consisting of five, the members of which alternate with one another. In the case of one of these sets of zones—the *ambulacral zones* or *ambulacral areas* already referred to—each of the plates is perforated towards its outer end by two minute pores, the *ambulacral pores*, for the protrusion of the tube-feet. In the other five zones, the *inter-ambulacral zones* or *areas*, the plates are not perforated. At its anal end each area, ambulacral or inter-ambulacral, ends in a single *apical plate*, so that the periproct is surrounded by a ring of ten plates, the *apical system* of plates (Fig. 328). Of these, the five that are situated at the ends of the ambulacral areas are termed the *ocular plates* (*oc*), owing to the fact that each of them bears a structure once supposed to be a rudimentary eye, but now known to be a tentacle; while the five opposite the inter-ambulacral areas are termed the *genital plates* (*gen*), each of them being perforated by an opening which is the aperture of one of the five *genital ducts*—the ducts of the ovaries or testes as the case may be. One of these genital plates (*madr*) has a swollen and spongy appearance, which distinguishes it from the others: this is the *madreporite*, through which, as in the case of the structure of the same name in the Starfishes, the madreporic canal communicates with the exterior. The two ambulacral areas between which the madreporite lies constitute the *bivium*, the remaining three the *trivium*.

On the inner surface of the shell, close to the edge of the peristome, there project inwards five processes, the *auricles* (Fig. 330, *aur*), one opposite each ambulacral area. Within the ring of auricles lies a complex structure termed **Aristotle's lantern** (Fig. 329). This consists of the five teeth (*e*), the apices of which are to be seen projecting through the mouth, together with a system of ossicles. The teeth are long, curved, and pointed: proximally each is supported by and partly embedded in a pyramidal ossicle, the *alveolus* (*a*), consisting of two halves united by a longitudinal suture. Firmly united to the base of the alveolus is a stout bar, the *epiphysis* (*b*). Adjacent epiphyses are in close contact with one another, and running inwards from their points of union are five radially-directed, stout bars, the *rotulae* (*c*), the inner ends of which unite to bound a circular aperture through which the oesophagus passes. With the inner end of each rotula is movably articulated

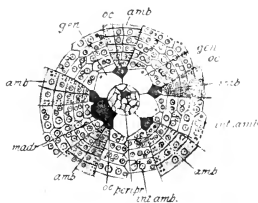

FIG. 328.—Apical system of plates and aboral extremities of zones of the shell of a **Sea-urchin**. *amb.* ambulacral zones; *gen.* genital plates; *int. amb.* inter-ambulacral zones; *madr.* madreporite; *oc.* ocular plates; *peripr.* periproct. (After Leuckart.)

a more slender bar, the *radius* (*d*), which runs outwards, parallel with, and closely applied to, the rotula, to end in a free, bifurcated extremity. Aristotle's lantern as a whole is in the shape of a five-sided pyramid, at the apex of which project the five teeth;

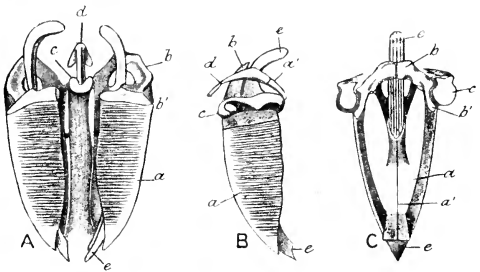

FIG. 329.—Lantern of Aristotle of **Echinus**. *A*, two of the five chief component parts apposed and viewed laterally. *B*, lateral, and *C* internal view of a single part. *a*, alveolus, and *a'*, suture with its fellow; *b*, epiphysis; *b'*, suture with alveolus; *c*, tooth; *d*, radius; *e*, rotula. (From Huxley's *Invertebrates*, after Müller.)

the pyramid is hollow, containing a passage which is the beginning of the œsophagus. The base has the appearance of a wheel, the tyre of which is represented by the five epiphyses, the spokes by the five rotulæ with the five radii in close contact with them, and the hub by the rounded central aperture. Passing between the various ossicles of the lantern, and from them to the auricles, are systems of muscles by means of the contractions of some of which the lantern as a whole can be protruded or retracted, while the action of others is to cause the alveoli by which the teeth are brought to bear on the food.

Nervous System.

—Passing outwards through each auricle, and running along the inner surface of the corona opposite the middle of each ambulacral area, is a *radial nerve* (Fig. 330, *rad. ne*). Within the ring of auricles the five radial nerves are connected with a *nerve-ring* (*nerv. r*) surrounding the mouth. At its distal end

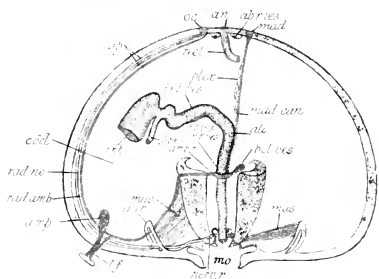

FIG. 330.—Lateral view of the internal organs of a **Sea-urchin** as seen on the removal of a half of the shell. *ab. r. ves.* hæmal strand, aboral ring; *amb. r.* ambulacral ring-canal; *amp.* ampulle; *an.* anus; *aur.* auricle; *cœl.* cœlome; *int.* intestine; *int. ves.* intestinal hæmal strands; *mad.* madreporite; *mad. can.* madreporic canal; *mo.* mouth; *mus.* muscles passing from the auricles to Aristotle's lantern; *nerv. r.* nerve-ring; *oc.* ocular plate; *or. r. ves.* hæmal strand, oral ring; *plex.* axial organ; *pol. ves.* Polian vesicle; *rad. amb.* radial ambulacral vessel; *rad. ne.* radial nerve; *siph.* siphon; *sp.* radial extension of the cœlome surrounding the nerve; *t. f.* tube-feet. (From Leuckart, after Hainann.)

each radial nerve is connected with the so-called *eye* (*oc*), borne by the corresponding ocular plate. These parts correspond to the *epidermal* nervous system of the Starfish, which, owing to the ambulacral grooves having become closed in to form narrow canals—the *epineural canals* (Fig. 331, *ep.*), covered over by the plates of the corona—is here more deeply situated; the deep and cœlomic systems are only feebly developed.

Ambulacral System.—Internal to each radial nerve, and pursuing a corresponding course, runs a *radial ambulacral vessel* (Figs. 330 and 331). From this are given off on each side a series of short branches to the tube-feet, with each of which is connected one of a series of compressed sacs, the *ampullæ* (*amp*), by two canals, one passing through each of the two pores. At their oral extremities

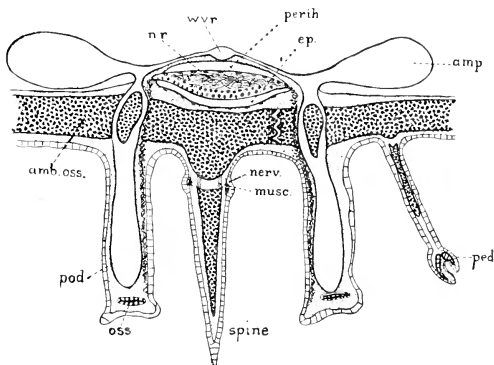

FIG. 331.—Diagrammatic transverse section of the ambulacral zone of an **Echinoid**. *amb. oss.*, ambulacral ossicle; *amp.*, ampulla of a tube-foot; *ep.*, epineural canal; *musc.*, muscles attaching spine to its tubercle; *nerv.*, nervous ring in base of spine; *n. r.*, radial nerve-cord; *oss.*, ossicle in the sucker of the tube-foot; *ped.*, pedicellaria; *perih.*, radial perihæmal canal; *pod.*, tube-foot; *w. r.*, radial ambulacral vessel. (After MacBride.)

the five radial ambulacral vessels unite with a *ring-vessel* surrounding the œsophagus. Appended to the ring-vessel are five *Polian vesicles* (*pol. ves.*) in the form of small mammillated bodies. A *madreporic canal* (*mad. can.*), corresponding to that of the Starfish, but with soft membranous walls devoid of ossicles, runs from the madreporite at the side of the periproct to the ring-canal.

The **enteric canal** (Fig. 332, *ali*) is devoid of the radial cœca which it presents in the Starfish: it is a wide, soft-walled tube, which winds round the interior of the corona in its passage from the mouth to the anus, held in place by a band of threads, the *mesentery*, passing out from it to the inner surface of the shell. It gives off a short diverticulum, the *siphon* (*siph*), which opens

into it at both ends; this, together with the intestine itself, probably acts as an organ for the respiration of the cœlomic fluid.

The **cœlome** contains a fluid in which, as in the Starfish, there are numerous corpuscles. Of these there are two kinds—*amœboid corpuscles* (*amœbocytes*) with long pseudopodia, and *vibratile corpuscles*, which closely resemble sperms, having a rounded head and a slender vibratile tail: the latter aid in bringing about a constant circulation of the cœlomic fluid.

The part of the cœlome containing Aristotle's lantern is completely cut off from the rest by the arrangement of the membrane enclosing the lantern, and the function of the branchiæ on the peristome is evidently the oxygenation of the cœlomic fluid enclosed in this compartment, which is known as the *lantern-cœlome*.

The **perihæmal** and **hæmal** or **lacunar** systems, as well as the *axial organ*, will be referred to in the account of the general structure of the phylum.

The **reproductive organs** consist of five masses of minute rounded follicles (Fig. 332, *ov*) situated in the anal portion of the shell, and each communicating with the exterior by its duct, which perforates the corresponding genital plate. The sexes are distinct; as in the Starfish, there is little difference to be

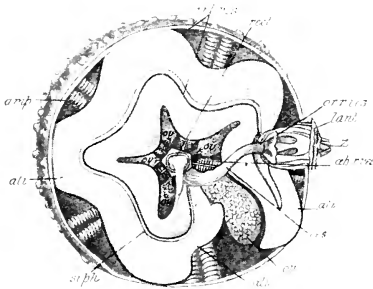

FIG. 332.—Alimentary canal and other organs of **Sea-urchin** as seen when the oral half of the corona has been removed. *ab. r. ves.* aboral ring of the hæmal system; *ali.* alimentary canal; *amp.* ampullæ; *int. ves.* intestinal blood-vessels; *lant.* lantern of Aristotle; *œs.* oesophagus; *or. r. ves.* oral ring-vessel of the hæmal system; *ov.* ovary; *rect.* rectum; *siph.* siphon; *z.* teeth. (From Leuckart, partly after Cuvier.)

observed between the ovaries of the female and the testes of the male until we come to examine their microscopic structure. The genital rachides which in the Starfish connect the gonads with the genital stolon (p. 378) are aborted in the adult Sea-urchin.

The early stages in the **development** of the Sea-urchin are very similar to the corresponding stages in the development of the Starfish described on page 381. The bilateral larva of the Sea-urchin, which is termed a *pluteus*, is provided with a number of elongated arms or processes supported by delicate calcareous rods. A metamorphosis, in which the bilateral larva becomes converted into the radial adult, takes place as in the Starfish.

3. EXAMPLE OF THE HOLOTHUROIDEA.

A Sea-cucumber. — *Cucumaria* or *Colochirus*.

General External Features.—The body (Fig. 333) is elongated, in shape not unlike a miniature cucumber, somewhat irregularly five-sided, with an opening at each end. One end is somewhat thicker than the other, and the opening at this thicker (oral or anterior) end is the *mouth*, that at the opposite (aboral or posterior) end is the *anus*. The body is five-sided, and along each side there extends a double row of *podia* or *tube-feet*.

In *Colochirus* there is a very distinct *ventral* surface, into which three of the five sides enter, distinguished by the absence of the rows of tubercles that occur on the dorsal portion of the surface, and by the presence of three distinct bands of tube-feet. This ventral part of the body with its three ambulacral areas is the equivalent of the *trivium* of the Starfish, the rest representing the *bivium*. On the dorsal surface, instead of typical tube-feet, there are papillæ devoid of sucking extremities, and similar appendages take the place of tube-feet at the ends of the three ventral bands. In *Cucumaria* the ventral surface is less distinctly defined, but its position is to be determined by reference to the tentacles (*vide* p. 394); there are no papillæ.

The ventral surface is, it is to be noticed, *parallel* with the axis joining mouth and anus, and the body, when compared with that of the Starfish or Sea-urchin, is greatly drawn out in the direction of the line joining mouth and anus.

There are no definite calcareous plates; but the integument is tolerably hard, owing to the presence in its substance of innumerable microscopic calcareous *spicules*, very variable in shape in different species of *Cucumaria*, and in *Colochirus* having the form of sieve-like or lattice-like plates, some of which are to be found even in the walls of the tube-feet. The tube-feet are, like those of the Starfish, used in locomotion, progression being effected by

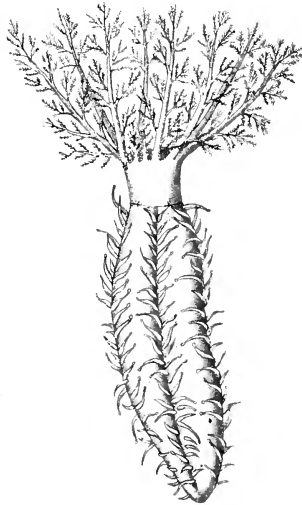

FIG. 333.—*Cucumaria planici*. Entire animal seen from the ventral surface. (From Hertwig's *Lehrbuch*, after Ludwig.)

creeping with the ventral surface applied to the ground. In a Sea-cucumber living undisturbed under natural conditions there will be found protruding through the mouth a circlet of ten *tentacles*, which are to be looked upon as greatly developed and specially modified podia. These are tree-like in shape—a central stem giving off a number of short branches, which may in turn be branched—and they are highly sensitive and contractile. Two of these tentacles will be seen to correspond to each of the ambulacral areas. The pair situated opposite the middle ambulacral area of the ventral surface are very much smaller than the others, and will be observed to perform the special function of pushing the food-particles into the mouth. All the tentacles are drawn completely back within the mouth when the animal is disturbed.

Structure of Body-wall.—When the wall of the body is divided, it is found to consist, in addition to the hardened *integumentary* layer, of two layers of *muscle* in addition to a thin layer of cells, the *peritoneum* or *cœlomic epithelium*, lining the cœlome. The outer layer of muscle is a complete, continuous layer of muscular fibres which have a circular arrangement, *i.e.* are arranged in a ring-like manner around the long axis of the body; while the inner layer is not continuous, consisting, in fact, merely of five flattened bands which run longitudinally from the oral to the anal extremities, each underlying one of the ambulacral areas. In close contact with each of these bands, on its inner surface, runs a *radial ambulacral vessel* (Fig. 334, *rad. amb*) together with a *radial nerve*.

Ambulacral System.—Just behind the bases of the tentacles, and surrounding the beginning of the œsophagus, is a *circular ambulacral vessel* (*ring. ves*) which gives off the five *radial vessels*; these first run forwards and give off branches to the tentacles, and then backwards, passing along the ambulacral areas and giving off branches to the tube-feet, each of which is provided with its *ampulla*. From the ring-vessel also arises a large pear-shaped *Polian vesicle* (*pol. ves*), and a short sinuous canal, the *madreporic canal* (*mad. can*), which ends in a perforated extremity—not situated, like the madreporite of the Starfish or Sea-urchin, on the outer surface of the body, but in the interior of the cœlome.

A **nerve-ring** surrounds the mouth and gives off the five *radial nerves*.

Both **perihæmal** and **hæmal** systems are well developed. The latter comprises a ring-like strand (*ri. bl. ves*) situated close to the nerve-ring and sending off five radial strands, as well as dorsal and ventral strands (*int. ves*) accompanying the enteric canal, and a plexus surrounding the left *respiratory tree* (p. 396).

The **cœlome** contains a fluid in which float numerous amœbocytes, similar to those of the Starfish, and also a number of

flattened nucleated corpuscles containing a red colouring matter—hæmoglobin—almost identical with that which gives the red colour to the blood of the higher animals.

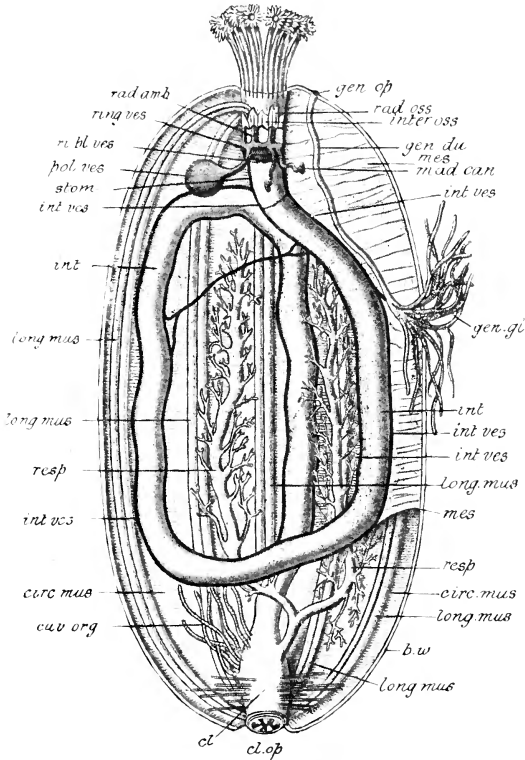

FIG. 334.—Internal organs of a **Holothurian** as seen when the body-wall is divided along the middle of the dorsal surface. *b. w.* body-wall; *circ. mus.* circular layer of muscle; *cl.* cloaca; *cl. op.* cloacal opening; *cuv. org.* Cuvierian organs; *gen. op.* genital aperture; *gen. du.* genital duct; *gen. gl.* gonad; *int.* intestine; *inter. oss.* inter-ambulacral ossicles; *int. ves.* intestinal hæmal strands; *long. mus.* longitudinal band of muscle; *mad. can.* madreporic canal; *mes.* mesentery; *pol. ves.* Polian vesicle; *rad. amb.* radial ambulacral vessel; *rad. oss.* ambulacral ossicles; *ri. bl. ves.* ring strand of hæmal system; *resp.* respiratory trees; *ring-ves.* ring-vessel of the ambulacral system; *stom.* stomach. (After Leuckart.)

The enteric canal is, as already mentioned, surrounded at its oral extremity by the circlet of tentacles, and within these, when they are fully exerted, is a narrow peristome with the mouth in

the centre. When the tentacles are retracted the peristome becomes inverted, so that peristome and tentacles are enclosed within a chamber, the *buccal chamber*, into which the mouth leads. Surrounding the *œsophagus*, which lies immediately behind the buccal chamber, is a circlet of ten *circum-œsophageal ossicles*, five ambulacral (*rad. oss*) in position, and five inter-ambulacral (*inter. oss*). Through each of the former pass the corresponding radial ambulacral vessel, hæmal strand, and nerve. The alimentary canal itself is a simple cylindrical tube, only indistinctly marked out into *œsophagus*, stomach (*stom*), and intestine. It forms several coils within the *cœlome*, to the wall of which it is attached by a thin membranous dorsal mesentery, and terminates behind in a comparatively wide chamber, the *cloaca* (*cl*).

Opening into the cloaca is a pair of remarkable organs of doubtful function, the so-called *respiratory trees* (*resp*). Each of these, beginning behind in a single tubular stem, becomes elaborately branched in front, some of the branches reaching nearly to the anterior end of the body-cavity. Each of the terminal branches ends in a small enlargement or ampulla. Besides having to do, most probably, with the respiration of the *cœlomic* fluid and with the excretion of waste-matters, these organs have a hydrostatic function; it is through them also that, when the tentacles are withdrawn, the overplus of fluid which would impede their retraction is got rid of, and by their means, in like manner, that the quantity is again increased when the tentacles are protruded again. In all probability it is through the permeable walls of these organs that additional supplies of sea-water are received into the *cœlome*, and thus reach the ambulacral system through the perforated end of the madreporic canal.

Reproductive Organs.—The Sea-cucumber, like the Starfish and Sea-urchin, has the sexes separate. *Ovaries* and *testes* (*gen. gl*) are very like one another, and consist of bunches of tubular follicles, which communicate with the exterior by means of a duct opening on the dorsal surface some little distance behind the oral end (*gen. ap.*).

The early stages of **development** are very similar to those of the Starfish (p. 381). The bilateral larva, however, assumes a shape somewhat different from that of the Asteroidea, and is termed the *auricularia* (Fig. 348): it has a number of short processes developed in the course of the ciliated bands. The larval mouth and *œsophagus*, instead of being abolished as in the case of the Starfish, persist to the adult condition.

4. THE CRINOIDEA.

A Feather-star.—*Antedon rosacea*.

General External Features.—In the Feather-star (Fig. 335), as in the Starfish, there are to be recognised a central disc and a

series of five radiating arms. In the natural position of the animal the side of the disc which corresponds to the oral or actinal surface of the Starfish is directed *upwards*, and the aboral or

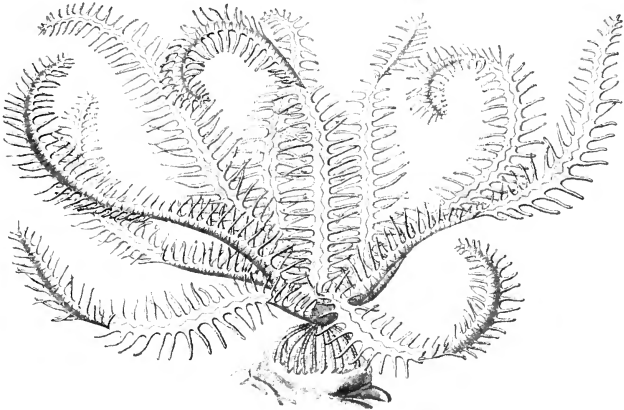

FIG. 335.—*Antedon*. Side view of entire animal (From Leuckart and Nitsche's Diagrams.)

abactinal surface *downwards*. The five arms are bifurcated at their bases; they are feather-like and highly flexible, acting as the locomotive organs of the animal, their alternate flexions and extensions resulting in a slow movement through the water. On the aboral side of the disc are whorls of slender, curved, cylindrical appendages, the *cirri* (Fig. 336), by means of which the Feather-star is enabled to anchor itself temporarily to a rock or a sea-weed.

On the oral side of the disc the body-wall is soft and flexible, containing only scattered irregular spicules of calcareous matter;

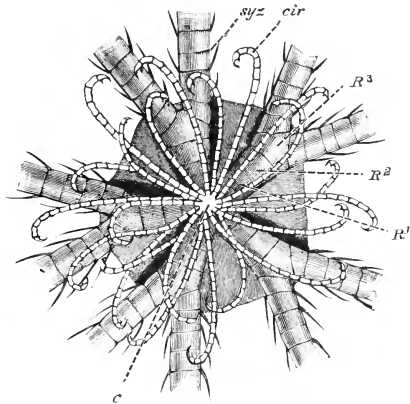

FIG. 336.—Aboral view of *Antedon*. *c*, centro-dorsal ossicle; *cir*, cirrus; *R*¹, *R*², *R*³, the three radial plates of one column; *syz*, syzygy or articulation. (After MacBride.)

and in the centre of this surface is an opening, the *mouth* (Fig. 337, *mo*). From the mouth five very narrow ciliated grooves, the *ambulacral* or *food-grooves*, radiate outwards towards the bases of the arms, near which they bifurcate, so that ten grooves are formed, one passing along the oral surface of each of the ten arm-branches to its extremity. The *anal opening* (*an*) is likewise on the oral surface, being situated on a papilliform elevation in the interspace between two of the radiating canals.

The aboral side of the disc is occupied by a large, flat, pentagonal ossicle, the *centro-dorsal ossicle* (Fig. 336, *c*; and Fig. 339, *CD*), bearing on its outer surface a number of little cup-like depressions, with which the bases of the cirri are connected. The cirri (*cirri*) consist each of a row of slender ossicles, covered, like all the rest of the animal, with epidermis, and connected together by means

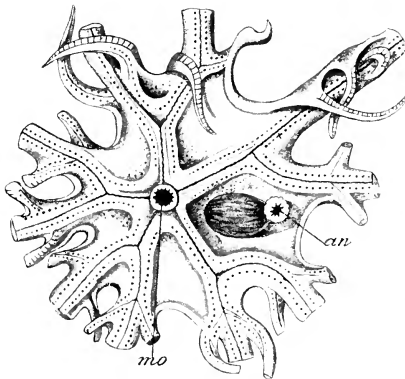

FIG. 337.—*Antedon*, oral (upper) surface of the central disc. *an*, anus; *mo*, mouth. (From Vogt and Jung.)

of muscular fibres. Concealed from view by the centro-dorsal ossicle is a thin plate termed the "*rosette*" (*ros*), formed by the coalescence of the *basals* of the larva. At the sides are five *first radial ossicles* (R^1), also partly concealed by the centro-dorsal ossicle: with each of these articulates a *second radial* (R^2), which is visible beyond the centro-dorsal. With each of the second radials articulate two *third radials*

(R^3), each forming the base of the corresponding arm-branch.

The ossicles of the arms—*brachials* ($Br.^1$, $Br.^2$)—are arranged in a single row in each arm. They are somewhat elongated in the direction of the long axis of the arm, strongly convex on their aboral surfaces, longitudinally grooved on the oral surface, and connected together by the investing epidermis and by bundles of muscular fibres, by the contractions of which the movements of the arms are brought about. Fringing the sides of each arm are two rows of side-branches, or *pinnules*, each supported by its row of connected ossicles, and each grooved along its oral surface.

The *coelome* contains numerous strands of connective-tissue which serve to suspend the various organs.

Extending through the arms and pinnules between the supporting ossicles and the ambulacral grooves are three canals, ciliated in

parts, which are prolongations of the cœlome (Fig. 338, *cœl. can.*). Two of these—the *subtentacular canals*—form a pair separated from one another by a median septum underlying the ambulacral groove. The other—the *cœliac canal*—runs between these and the supporting ossicles (*oss*). The sub-tentacular canals and the cœliac canal communicate with one another at the extremity of each pinnule.

The **enteric canal** begins with a wide, funnel-shaped *œsophagus* leading to a spacious *stomach* which gives off a number of short, blunt diverticula and a pair of longer, narrower, "hepatic" cœca, which are slightly branched at the ends. Distally the stomach becomes contracted and opens into a wide *intestine*, which winds round the cœlome, becoming narrower where it passes upwards to open on the exterior, the terminal part, or *rectum*, projecting as a tubular papilla on the surface. In the living animal the rectal tube is observed to undergo frequent movements of contraction and dilatation, by means of which water is drawn into and expelled from the intestine; so that here, as in the Sea-urchin, there would appear to be a process of intestinal respiration.

The **ambulacral system** consists of a *ring-vessel* surrounding the mouth, and a series of *radial vessels* (Fig. 338, *rad. amb.*) which run in the ambulacral grooves, giving off branches to the pinnules. Connected with the radial vessels and their branches are a

series of minute tubular ciliated appendages, the *podia* or so-called *tentacles* (Fig. 339, *tent.*), which are homologous with the tube-feet of the Starfishes and Sea-urchins, but are devoid of terminal suckers. These are not organs of locomotion: they bear numerous sensory papillæ, and are therefore to be looked upon as tactile organs, but they probably also have a respiratory function. Connected with the ring-vessel are a number of ciliated tubular diverticula, the *water-tubes*, which are suspended within the cœlome, and open freely into it at their extremities. A large number of vessels with minute ciliated openings—the *water-pores* (*wat. p.*)—lead through the actinal wall of the disc: these and the ciliated tubes are to be considered as together representing the madreporic canal and its openings in the Starfish and Sea-urchin.

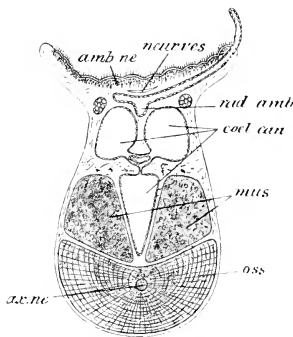

FIG. 338.—**Antedon**, transverse section of a pinnule. *amb. ne.* radial nerve of the superficial (ambulacral) nervous system; *ar. ne.* axial nerve; *cœl. can.* sub-tentacular and cœliac canals; *mus.* muscles; *neur. ves.* radial sinus of the perihemal system; *rad. amb.* radial ambulacral vessel giving off branches to the tentacles. Between the paired sub-tentacular and unpaired cœliac canals is the genital rachis. The small round bodies above the line from *rad. amb.* are the sacculi. (After Teuscher.)

The **nervous system** consists of two perfectly distinct parts—*superficial* and *axial* or *aboral*. A superficial radial nerve-ring (*ect. ne*) surrounds the mouth, and from it are given off a series of nerves—thickenings of the epidermis of the ambulacral grooves and their offsets—which extend throughout the length of the arms and pinnules. In the axis of the supporting ossicles of the arm is an *axial nerve* (*ax. co*), which gives off branches (Fig. 338, *ax. ne*) running through the axes of the ossicles of the pinnules. The axial nerves are connected internally, not with the circumoral nerve-ring, but with a central body situated below the rosette,

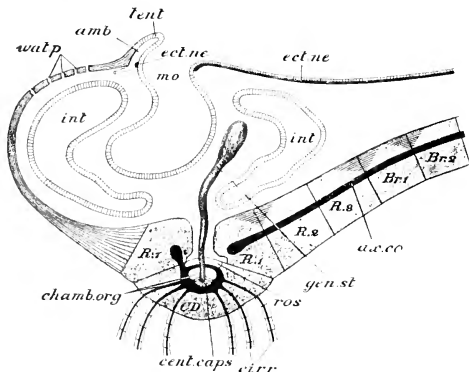

FIG. 339.—**Antedon**. Diagrammatic view of a median vertical section through the disc, passing through one radius and one inter-radius. *amb*, ambulacral vessels; *ax. co*, axial nerve-cord passing through the ossicles of the arm; *Br.¹ Br.²* brachial ossicles; *CD* centro dorsal ossicle; *cent. caps*, central capsule; *chamb. org*, chambered organ; *cirr*, cirri; *ect. ne*, ambulacral (epidermal) nerve-ring and radial nerve; *gen. st*, genital stolon; *int*, intestine; *mo*, mouth; *R.¹ R.² R.³* radials; *ros*, rosette; *tent*, tentacles; *wat. p.* water-pores. (After Milnes Marshall.)

in the interior of the centro-dorsal ossicle. This, the *central capsule* (Fig. 339, *cent. caps*), forms the investment of a body termed the *five-chambered organ* (*chamb. org*) divided into five parts by radial septa, and continuous with the aboral end of the *genital stolon*. Processes from the five angles

of the central capsule combine to form a pentagonal ring from which pass outwards the axial nerves of the arms. This system controls the movements of the arms. Aborally the central capsule gives off nerves to the cirri.

A system corresponding to the **perihæmal system** of the Starfish is present, though reduced, and there is a highly-developed and complicated **lacunar** or **hæmal system**.

Numerous bodies termed the **sacculi**, the character of which has given rise to much discussion, occur regularly arranged along the ambulacral grooves and also in other parts. These are small spherical bodies which become vividly coloured when treated with staining agents. They are essentially collections of amœboid cells which may represent reserve materials, stored up for the nutrition of the animal, or may contain excretory matters.

The **reproductive organs**—*ovaries* or *testes*, as the case may be—are lodged in the dilated bases of the pinnules, which become considerably enlarged as the ova or sperms mature, those next to the bases of the arms alone remaining sterile. When mature, the sexual elements escape by means of short ducts. Each gonad is one of the terminal parts of a system of cords of cells enclosed in narrow tubes extending from a central part or *genital stolon* (*gen. st.*)—connected dorsally with the chambered organ—outwards through the arms; the terminal portions, lying in the pinnules, are dilated to form the reproductive organs, and the cells of their epithelium become developed into ova or sperms, while the rest constitute a non-fertile connecting rachis. This system is enclosed throughout by a plexus of hæmal lacunæ.

Like the rest of the Echinoderms, the Feather-star undergoes a **metamorphosis** (Figs. 349 and 350). It passes through a free-swimming ciliated larval stage, which is followed by a fixed stalked stage known as the "*pentacrinoid*" larva on account of the resemblance which it bears to the adult *Pentacrinus*, one of the permanently fixed members of the same class. This fixed pentacrinoid larva passes into the adult free-swimming Feather-star by the development of the dorsal cirri, the elongation of the arms, and the absorption of the stalk.

5. DISTINCTIVE CHARACTERS AND CLASSIFICATION.

The Echinodermata are radially symmetrical animals, the radial arrangement of whose parts imperfectly conceals a more obscure bilateral symmetry. The surface is covered with an exoskeleton of calcareous plates or ossicles, which usually support a system of movable or immovable calcareous spines. There is a large body-cavity or cœlome, and well-developed alimentary, nervous, and vascular systems. A characteristic system of vessels, the ambulacral system, is connected with the locomotion of the animal, as well as with other functions: the organs of locomotion are in most cases elastic and contractile tubular bodies, the tube-feet, which are appendages of the ambulacral system. Nearly all the systems of organs of the animal partake to a greater or less extent of the general radial form of the body. Reproduction is entirely sexual. In the course of its development from the egg the Echinoderm passes through a peculiar larval stage, in which the symmetry of parts is bilateral, instead of radial as in the adult animal. All the Echinodermata are marine.

The Echinodermata are classified as follows:—

SUB-PHYLUM I.—ELEUTHEROZOA.

Echinodermata devoid of a stalk, and always freely locomotive in the adult condition: with a system of radial ambulacra in the form

of grooves or areas radiating out from the mouth, and containing a double series of tubular appendages of the ambulacral system, the tube-feet, usually employed in locomotion, and in the majority of cases provided with terminal suckers: the anus usually aboral; the mouth on the surface that is habitually directed downwards, or at the end habitually directed forwards in locomotion.

CLASS I.—ASTEROIDEA.

Free Echinoderms with star-shaped or pentagonal body, in which a central disc and usually five arms are more or less readily distinguishable, the arms being hollow, and each containing a prolongation of the cœlome and of its contained organs. There are distinct oral and aboral surfaces, on the former of which the anus and the madreporite are situated, and on the latter the mouth and five narrow ambulacral grooves lodging the tube-feet. The larva has the form either of a *bipinnaria* or of a *brachiolaria*. This class includes the Starfishes.

ORDER 1.—SPINULOSA.

Asteroidea with only two rows of tube-feet in the ambulacral grooves; the dorsal surface covered with small close-set plates bearing spines.

ORDER 2.—VELATA.

Asteroidea having the dorsal surface covered with a single membrane or velum supported by sheaves of spines, or with a number of such structures.

ORDER 3.—PAXILLOSA.

Asteroidea in which the dorsal surface is covered with paxillæ. The pedicellariæ are never forcipulate.

ORDER 4.—VALVATA.

Asteroidea with granular surface without prominent spines; valvate pedicellariæ.

ORDER 5.—FORCIPULATA.

Asteroidea with forcipulate pedicellariæ.

CLASS II.—OPHIUROIDEA.

Star-shaped free Echinoderms, with a central disc and usually five arms, which are more sharply marked off from the disc than in the Asteroidea and which contain no spacious prolongations of the cœlome. There are distinct oral and aboral surfaces. The anus is absent; the mouth, as well as the madreporite, on the oral

surface. Except in one fossil order there are no ambulacral grooves. The larva is a *pluteus*. This class includes the Sand-stars and Brittle-stars (Figs. 341 and 342).

ORDER 1.—LYSOPHIURÆ.

Extinct Ophiuroids with ambulacral grooves.
Silurian and Devonian.

ORDER 2.—STREPTOPHIURÆ.

Ophiuroids in which the ambulacral ossicles articulate with one another by simple ball-and-socket joints.

ORDER 3.—CLADOPHIURÆ.

Ophiuroids in which the ambulacral ossicles articulate with one another by means of hour-glass-shaped surfaces. The arms may be branched.

ORDER 4.—ZYGOPHIURÆ.

Ophiuroids in which the movement of the ambulacral ossicles on one another is restricted by the presence of lateral processes and pits.

CLASS III.—ECHINOIDEA.

Free Echinoderms with globular, heart-shaped, or disc-shaped body enclosed in a shell or corona of close-fitting, firmly united calcareous plates. The mouth is nearly always polar; the anus usually at the opposite (aboral) pole; the madreporite is close to the latter. There are no ambulacral grooves; but the surface is divided into alternating ambulacral and inter-ambulacral zones or areas, which usually run from pole to pole. The larva is a *pluteus*. This class includes the Sea-urchins, with the Heart-urchins and Cake-urchins.

ORDER 1.—REGULARIA.

Echinoidea with globular corona containing, in most cases, twenty meridional rows of plates. Mouth and anus polar. A lantern of Aristotle is present. This order includes the Sea-urchins.

ORDER 2.—CLYPEASTRIDEA.

Echinoidea with more or less flattened corona, with the mouth central, the anus excentric. A lantern of Aristotle is present. This order includes the Cake-urchins (Fig. 346).

ORDER 3.—SPATANGOIDEA.

Heart-shaped Echinoidea with the mouth and anus excentric. No lantern of Aristotle. This order includes the Heart-urchins (Fig. 345).

CLASS IV.—HOLOTHUROIDEA.

Free Echinoderms with elongated, cylindrical or five-sided body, having the mouth and anus at opposite extremities. The body-wall is usually only supported by scattered ossicles or spicules. There is no external opening to the madreporic canal (except in some *Elasipoda*). The surface usually exhibits five ambulacral areas; but these may be absent. There is a circlet of large oral tentacles. The larva is an *auricularia*. This class includes the Sea-cucumbers and "Bêche-de-mer."

ORDER 1.—ELASIPODA.

Holothuroidea with well-marked bilateral symmetry, with tube-feet on the ventral surface (which is flattened) and papillæ on the dorsal. Confined to the deep sea.

ORDER 2.—PEDATA.

Holothuroidea with tube-feet either in longitudinal rows or scattered irregularly over the surface.

ORDER 3.—APODA.

Holothuroidea devoid of tube-feet and of radial ambulacral vessels.

SUB-PHYLUM II.—PELMATOZOA.

Echinodermata which are usually fixed at the base, and usually supported on a stalk composed of a row or rows of ossicles (Fig. 347): the mouth on the free surface, near or in the centre, and having extending out from it on the oral surface a radially arranged system of narrow, ciliated ambulacral grooves, having the function of food-grooves, which may run between the plates of the theca, on the surface of the theca, or along the oral surfaces of a system of radial processes or arms given off from it. The tube-feet of other Echinoderms, when represented, take the form of small, tubular, strongly ciliated appendages (tentacles) without suckers: the anus usually on the oral surface.

CLASS I.—CRINOIDEA.

Mostly fixed, stalked Pelmatozoa in which there is a theca comprising five regularly arranged radial and five basal plates, giving off five, usually branched, jointed processes or arms; with food-grooves radiating out from the mouth along the oral surfaces of the arms, and extending along their branches: the central parts of the ambulacral, nervous, and reproductive systems, and of the cœlome, lodged in the theca, send extensions through the arms.

This class comprises, together with many extinct forms, the only living Pelmatozoa.

SUB-CLASS I.—MONOCYCLICA.

Crinoidea in which the base of the theca comprises basals only.

SUB-CLASS II.—DICYCLICA.

Crinoidea in which the base comprises basals and infra-basals.

CLASS II.—CYSTOIDEA.

Fixed, stalked, or sessile Pelmatozoa, with the plates of the theca sometimes irregular, sometimes arranged in a regular radial system, with food-grooves extending for a longer or shorter distance over the surface of the theca, sometimes on special plates lying above those of the latter, their terminal parts extending on to a varying number of unbranched arms or "fingers"; the theca perforated completely or partially by numerous pores which are supposed to have lodged respiratory processes.

Lower Silurian to Carboniferous.

CLASS III.—BLASTOIDEA.

Fixed Pelmatozoa with well-developed stalk, and theca with a regular system of plates; with five, rarely four, food-grooves radiating out from the central mouth, and each borne on a special "lancet plate," the inter-radial intervals between which are occupied by a corresponding number of oral or "deltoid" plates. The grooves are bordered by a series of side plates bearing small branches or "fingers" to which side branches of the grooves extend. In the intervals between the grooves on the aboral sides of the deltoids are a whorl of plates perforated by the apertures of groups of internally situated respiratory folds (*hydrospires*). The anus is eccentrically situated on the oral surface.

Upper Silurian to Carboniferous.

CLASS IV.—EDRIASTEROIDEA.

Fixed (or sometimes free?) Pelmatozoa, usually sessile, rarely with a short stalk; with sac-like, cushion-shaped or disc-shaped theca made up of numerous plates devoid of any regular arrangement and without any appendages; with central mouth and five straight or curved radiating food-grooves bordered by covering plates: anus and madreporite on oral side.

Cambrian to Carboniferous.

CLASS V.—CARPOIDEA.

Pelmatozoa with a well-developed stalk, with the body laterally compressed, with only two food-grooves running out from the mouth. Theca composed of numerous small irregular plates with larger lateral plates forming a framework along the margins.

Cambrian and Silurian.

Systematic Position of the Examples.

Asterius rubens is a species of the genus *Asterius*, which, with several others, constitutes the family *Asteriidae* of the order *Forcipulata*. The family *Asteriidae* is characterised among the families of the *Forcipulata* by the following distinctive features:—The ossicles of the aboral surface are small, unequal, reticulate plates, bearing isolated or grouped spinelets (*paxillæ*). The margin of the actinostome is defined by the ambulacral plates. The

pedicellariæ are of two forms, forceps-like and scissors-like. The tube-feet are in four rows. *Asterias* differs from the other genera of the family in having well-developed reticulate dorsal ossicles bearing definite spines.

The Sea-urchins of which a short description has been given are the genera *Strongylocentrotus* and *Echinus*, but the description is sufficiently general to apply to any member of the family *Echinidæ*, to which these genera, with a number of others, belong. The family *Echinidæ* is one of about five families of the sub-order *Ectobranchiata*, the members of which all differ from the other sub-order—*Entobranchiata*—of the *Regularia*, or regular Sea-urchins, in the possession of dermal branchiæ, and in having the auricles in the form of complete arches.

The Sea-cucumber (*Cucumaria* or *Colochirus*) is a member of the *Stichopoda*—one of the families of the sub-order *Dendrochirota* of the *Pedata*, or foot-bearing Holothurians. The *Dendrochirota* differ from the *Aspidochirota*—the other sub-order—mainly in having arborescent instead of shield-shaped tentacles, and the *Stichopoda* differ from the rest of the *Dendrochirota* in having the tube-feet arranged in five regular zones. The genus *Cucumaria* is distinguished from the rest by having ten tentacles with the two ventral smaller than the others. *Colochirus* is closely allied to *Cucumaria*, the principal distinction being the presence in the former of papillæ taking the place of tube-feet in certain situations, as already noted.

The Feather-star (*Antedon rosacea*) is a member of the family *Comatulidæ*, which is distinguished from the four other living families comprised in the class *Crinoidea* of the *Pelmatozoa* by the absence of a stalk in the adult condition.

6. GENERAL ORGANISATION.

General Form and Symmetry.—Like the *Cœlenterata*, the *Echinodermata* are radially symmetrical, the body being capable of division into a series of sub-equal *antimeres* along a series of radiating planes at right angles to the principal axis. In the majority of existing forms (*Asteroidea*, *Ophiuroidea*, and *Crinoidea*) the radial symmetry is expressed in the external form of the body, which is produced into a number of radially disposed parts, the *arms* or *rays*, arranged around a smaller or larger *central disc*. But in the *Echinoidea* the body is sub-spherical, and in the *Holothuroidea* sub-cylindrical, the radiate arrangement being in these classes indicated externally only by the distribution of the *podia*, and internally by that of certain of the systems of organs.

Although, however, the general external form and the arrangement of some of the internal organs in the *Echinodermata* indicates a radial symmetry, it is invariably found that this radial arrange-

ment serves to hide a *bilateral* symmetry which may be more primitive. This is best marked in the larva, which has pronounced bilateral instead of radial symmetry, but is quite recognisable in the adult. In all Echinoderms there is, passing through the primary axis, a plane—the *median* plane—along which, and along which alone, the body is capable of being divided into two equal—or, to speak more correctly, approximately equal—right and left halves. The existence of such a single median plane is, as already explained (p. 43), indicative of the bilateral form of symmetry.

The body is most usually five-rayed (Ophiuroidea, most Asteroidea, Crinoidea), cylindrical (most Holothuroidea), or globular (most Echinoidea), the surface in the two last cases being marked by five bands or zones of tube-feet, which divide it into five *ambulacral* and five *inter-ambulacral* areas. In the Ophiuroidea and Asteroidea two of the rays—constituting the *bivium*—have between them the *madreporite*, marking the position of the madreporic canal of the ambulacral system; the remaining three rays form the *trivium*. The median plane passes through the madreporite, and thus midway between the two rays of the bivium, and bisects longitudinally the middle ray of the trivium. A corresponding disposition of the parts is traceable also, as will be subsequently shown, in the cylindrical and globular Echinoderms.

In all the Echinodermata aboral or abactinal and oral or actinal surfaces are more or less distinctly recognisable. In the Asteroidea, Ophiuroidea, and Echinoidea, the actinal surface is that in the middle of which the mouth is situated, and which is, in the natural position of the animal, directed downwards or towards the surface to which it is clinging. The opposite abactinal surface is, in the majority of the Asteroidea and Echinoidea, marked by the presence of the anal aperture: in the Ophiuroidea and some Asteroidea the anus is absent; in some Echinoidea it is situated on the border between the two surfaces, or even on the oral surface. In the Crinoidea the oral surface, which is habitually directed upwards in the natural position of the animal, bears both mouth and anus, the former central, the latter eccentric and inter-radial. In the fixed Crinoids the abactinal or aboral surface has attached to its centre the distal end of the stalk; in the free forms it has connected with it whorls of slender curved appendages, the *dorsal cirri*, by means of which temporary attachment is effected. In the Holothurians, owing to the elongation of the body in the direction of the line joining mouth and anus, oral and aboral surfaces corresponding to those of the other classes are not distinguishable; but in many, as for example in *Colochirus*, there is a marked difference between one surface—the *dorsal*, which is habitually directed upwards, and another—the *ventral*, which is habitually directed downwards.

In considering the general external form in the various classes of Echinoderms, we have to take into account the arrangement of the *tube-feet*—the organs of locomotion—as these have important relations to the other parts and to the whole plan of organisation of the animal. These organs, as previously explained, are tubular appendages with highly elastic and contractile muscular walls, capable of being stretched out so as to extend a long way from the surface of the body. In the majority of cases the tube-foot has at its extremity a *sucking-disc*, by means of which it can be attached; in a few, however, this sucking-disc is absent.

The *epidermis* is ciliated in all but Holothuroidea. In the subjacent dermal layers there are always present, except in Pelagothuria and Rhabdomolgus (Holothuroidea), calcareous bodies or *ossicles*, varying very greatly in form and arrangement in the different groups. Movable or immovable calcareous *spines* or *tubercles* projecting on the surface are very general. Peculiarly modified spines, termed *pedicellariæ*, are commonly, though not universally, present in certain parts in the Echinoidea and Asteroidea. A pedicellaria consists in essence of two or three calcareous jaw-like pieces or valves, movably articulated together, and capable of being separated or approximated by the contraction of bundles of muscular fibres; sometimes there is a long stalk; sometimes (as in the case of *Anthenea*, p. 380) a stalk is absent; during life the jaws or valves keep opening and closing. That such specialised structures have some important function to perform there can be no doubt, but there is some uncertainty as to what their special purpose is. According to some observers, the pedicellariæ of the Sea-urchin have been seen passing from one to another the particles of fæcal matter discharged from the anus, and their function would thus appear to be a cleansing one. On the other hand, it is stated that when a Sea-urchin is attacked the spines may be bent aside from the assailed portion of the surface so as to allow of the pedicellariæ being brought to bear as defensive weapons on the assailant, and from these and other observations that have been recorded, both on Asteroids and on Echinoids, it is concluded that the main function of these appendages is to act as defensive organs. Pedicellariæ are absent in the Ophiuroids, but in the Euryalida there are peculiar hook-like organs of adhesion, most abundant on the oral surface and towards the extremities of the arms. The *sphæridia*, which have already been referred to as occurring in the Sea-urchin, are only doubtfully to be regarded as modified spines; they are confined to the Echinoidea. Also confined to that class are the *clavulae*—slender spines covered with strong cilia, which occur in bands (*fascioles*) on the surface of the Spatangoids. Larger spines, resembling the clavulae in being covered with strong cilia, occur also on the aboral surface in the Clypeastroids and some Asteroids. The currents

produced by the action of their cilia serve to keep constantly renewed the water in the neighbourhood of the anus and of the respiratory podia or the papulae.

There are two principal **systems of plates** to be recognised, an *oral* and an *apical*; the former corresponding with the oral or actinal, and the latter with the aboral or abactinal surface. The former vary considerably in the different classes: the constant elements are five *orals*, which may or may not be recognisable in the adult. The apical system consists (1) of a *central* plate; (2) of five *basals* which are inter-radial in position; (3) of five *radials* which are radial in position. In the Asteroidea (Fig. 324) the radials are late in making their appearance; before they are developed five *terminal* plates have become distinct, one at the end of each rudimentary arm; these are carried outwards by the extension of the arm, and each supports the corresponding tentacle. As a rule these plates of the apical system are only distinct in the young condition. In the Ophiuroidea the arrangement resembles that observable in the Asteroidea. In the Echinoidea (Fig. 328) the basals (genitals) are perforated by the ducts of the reproductive organs; the radials (oculars) are perforated for the tentacles: the central (*anal*) rarely persists as a single plate in the adult, usually becoming broken up into a number of irregular plates. In the stalked Crinoidea the term central has been applied to a plate which is transformed into the disc of attachment at the base of the stalk, but the correspondence between this and the similarly named plate in the other classes is very doubtful; the ossicles of the stalk intervene between it and the basals. In the free forms the uppermost segment of the larval stalk, uniting with the central and the infra-basals, is transformed into a *centro-dorsal plate*, and the basals nearly always unite into a *rosette-plate*, which is concealed from view by the centro-dorsal and the radials. The apical system of plates is apparently not represented in the Holothuroidea.

Modifications of Form in the Five Classes.—The general shape in the **Asteroidea** is, as already pointed out, that of a star. There is a central part, or *central disc*, from which proceeds a system of radially disposed *arms* or *rays*. The central disc and the rays are usually compressed in the vertical direction, as in *Anthenea* and *Asterina*, but in some Starfishes the rays are approximately cylindrical; they nearly always taper distally. In the majority of Starfishes, as in the examples described, the arms are five in number, except in malformed individuals; but in some they are six, in others seven, eight, or more. The proportions borne by the arms to the central disc are subject to considerable variation. In some, as in *Asterias*, the arms are long, and the central disc appears as little more than their point of union; in others, again, owing to coalescence of the arms, the whole Starfish has the form of a five-sided disc, in which the arms are represented

only by the five angles; while between these two extremes there are numerous intermediate gradations. The *Brisingiæ* differ from all the rest of the class in having the arms almost as sharply separated off from the central disc as in the Ophiuroids.

The *abactinal* or *aboral* and the *actinal* or *oral* surfaces are always distinctly marked off from one another. In the middle of the latter (Fig. 340) is the *mouth*, running out from which are five or more narrow *ambulacral grooves*, one of which is continued along the oral surface of each arm to its extremity. Near to, but not quite in, the middle point of the aboral surface is the *anal aperture*, absent in a few instances; and on the same surface, nearer the

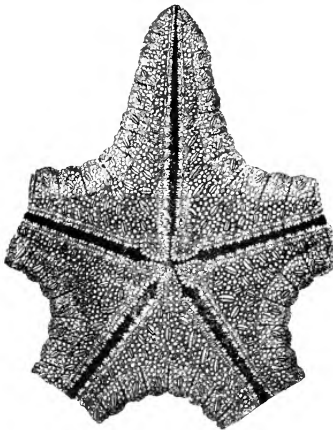

FIG. 340.—*Anthenea*. View of oral surface.
(After Sladen.)

margin, between the two rays of the bivium in the five-rayed Starfishes, is the *madreporite*, a finely grooved calcareous plate perforated by a number of minute apertures. In some fossil Starfishes it is situated on the oral surface. Sometimes instead of one madreporite there are several.

The wall of the body in the Starfishes contains a number of calcareous *ossicles*, movably articulated together and connected by bands of muscle, so that, though the body is firm, and in the dried condition often quite rigid, the arms are capable during life of slow movements of flexion and extension, enabling the

animal to creep through comparatively small fissures and crannies. A special system of ossicles—the *ambulacral ossicles*—are arranged in a double row along each ambulacral groove, the ossicles of the two rows articulating movably with one another at the apex of the groove. At the end of the arm the two rows of ambulacral ossicles end in a *terminal* ossicle which supports the unpaired tentacle. *Spines* are invariably present, but are sometimes confined to the margins of the ambulacral grooves, in which position they are movably articulated with the underlying ossicles. *Tubercles* take the place of spines over most of the surface in many forms. In *Astropecten* and other Paxillosa the ossicles of the aboral surface take the special form to which the term *paxillæ* is applied. Each paxilla is a plate which is produced into a short rod, divided at its extremity into a number of radiating processes.

The *tube-feet* are arranged in a double row along each of the ambulacral grooves, each connected through an aperture between the ambulacral ossicles with an ampulla, or, exceptionally, with two ampullæ, situated in the coelome. Each double row of tube-feet terminates at the extremity of the arm in an unpaired appendage, the *tentacle*, which is tactile and olfactory, and not locomotive in function. The tube-feet are provided (except in *Astropecten*) with terminal suckers.

In the **Ophiuroidea** (Fig. 341) the *central disc* is much more sharply marked off from the arms than in the Asteroidea. The arms, which are usually five in number, rarely six, are comparatively slender and cylindrical, tapering towards the free extremities; in one group, the *Euryalida* (Fig. 342), they are branched. The mouth is in the middle of the oral surface of the disc, as in the Asteroidea, but there are no ambulacral grooves, and there is no anal aperture. Five pairs of slits on the oral surface (Fig. 341, C) lead into the genital bursæ, which receive the sperms and ova from the gonads, and which appear also to act as organs of respiration and perhaps also of excretion. The surface is covered with thin plate-like ossicles, usually beset along their edges with longer or shorter spines; sometimes irregular calcareous granules take the place of plates. Hook-like organs of adhesion are present only in the *Euryalida*. Each of the arms is supported by a row of internally situated *ambulacral ossicles*. Tube-feet are present and are protruded at the sides of the arms between the lateral plate-like ossicles; but they have no sucking-discs and no ampullæ, and locomotion is effected in the majority of the Ophiuroids by active flexions and extensions of the arms. In one genus there is a pair of fin-like appendages, supported by slender spines, on each joint of the arms. The madreporite is situated inter-radially on the

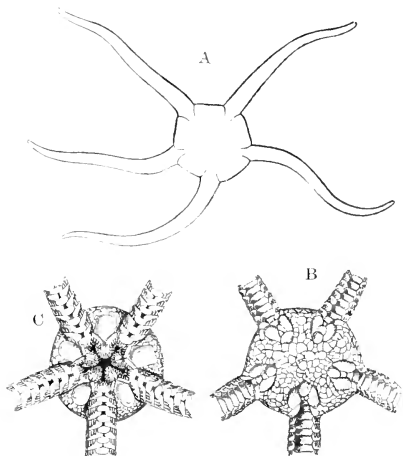

FIG. 341.—*Ophioglypha lacertosa*. A, outline, of the natural size. B, central disc, aboral surface. C, the disc, oral surface showing the mouth and genital fissures. (From Nicholson and Lydekker's *Palæontology*.)

of the arms. The madreporite is situated inter-radially on the

oral, and not on the aboral surface as in the Asteroidea. In the Euryalida there are five madreporites and five madreporic canals.

In the **Echinoidea** the body is either globular, or heart-shaped, or flattened and disc-like. The *exoskeleton* is in the form of a rigidly articulated system of calcareous plates, fitting closely together by sutures, so as to form a continuous shell or *corona*. Only *Asthenosoma* and allies, deep-sea forms, differ from all the rest in having a corona possessing a certain degree of flexibility and performing movements which are brought about by the contrac-

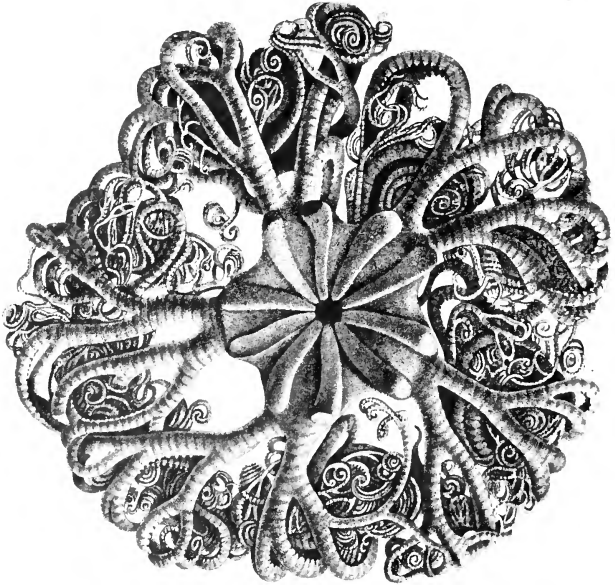

FIG. 342.—**Astrophyton arborescens**, aboral surface. (After Ludwig.)

tions of five longitudinal bands of muscle running along the ambulacral areas on the inner surface.

In the globular forms, or regular Sea-urchins, the mouth is situated at the oral pole of the globe, the anus at the aboral, and the plates of the corona are in twenty regular meridional rows, arranged in ten zones, five ambulacral and five inter-ambulacral, as described in the account of *Echinus*, with peristome, periproct, ocular and genital plates, and madreporite. *Spines* (Fig. 343), *pedicellariæ* (Fig. 344), and *sphæridia* are present, as already described (p. 387), the last-named appendages, however, being

absent in one group. The spines are usually defensive organs simply, but in some Sea-urchins they act also as the locomotive organs, the animal moving by their agency along the sea-bottom.

The podia or tube-feet, which are arranged in a double row in each ambulacral zone, are extremely extensible, and terminate in *sucking-membranes* strengthened by a calcareous *rosette*. An unpaired *tentacle*, corresponding to that of the Asteroidea, is supported on each of the ocular plates at the ends of the ambulacral zones. Two podia in each double row, situated on the peristome, are likewise of the nature of tentacles (*oral* or *buccal tentacles*), and are sometimes devoid of sucking-membranes. Corresponding to the *dermal branchiae* of the Asteroidea are, in the majority, five pairs of branched, hollow appendages surrounding the peristome.

Surrounding the mouth are five teeth, supported by an elaborate system of ossicles (*Aristotle's lantern*, see p. 389), and a ring of processes, the *auricles*, from the interior of the corona, surrounds this and gives attachment to some of the muscles by which the ossicles are moved.

In the heart-shaped forms or Heart-urchins (Fig. 345) the corona is heart-shaped, the mouth is usually more or less eccentrically placed on the oral surface, and the peristome is usually transversely elongated; the anus is on or near the border between the two surfaces. The ambulacral areas do not run continuously, but stop short at the margin (*petaloid ambulacra*); one of them, the anterior, is usually unlike the others and frequently devoid of pores. The genital and ocular plates are in the middle of the aboral surface, where the ambulacra converge, and are thus widely separated from the anus; there are usually only four genital plates, and the genital apertures may be reduced to two. Slender spines beset the entire surface and are the sole or chief organs of locomotion. Modified (ciliated) spines, the *clavulae*, arranged in narrow bands or *fusciolae*, are variously distributed round the anus and elsewhere;

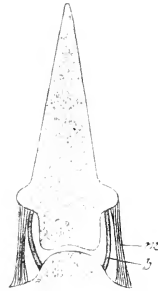

FIG. 343.—Diagram of spine of Sea-urchin, showing mode of articulation. *b*, ligament; *m*, muscle. (From Leuckart.)



FIG. 344.—Pedicellariae of *Arbacia punctulata*. (From Leuckart.)

but are sometimes entirely absent. A few pedicellariae are present in the neighbourhood of the mouth, and sphaeridia also occur. The "lantern of Aristotle," with its teeth, is not represented.

In the Clypeastridea or Cake-urchins the whole corona (Fig. 346) is usually greatly compressed so as to assume the form of a disc,

sometimes notched at the edges or pierced by fenestræ. The mouth is in the middle of the flat or concave oral surface, the anus eccen-

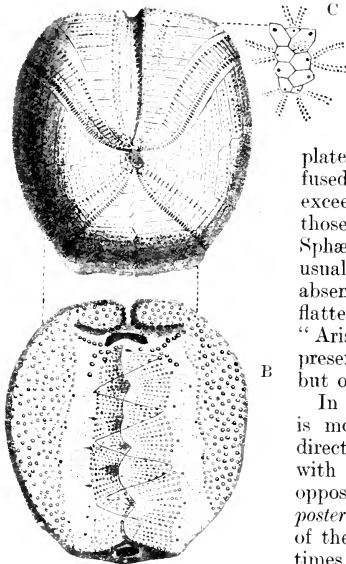

FIG. 345.—*Hemipneustes radiatus*.
A, aboral, and B, oral surface. C, apical plates. (From Bronn's *Tierreich*.)

trically situated near the margin. The ambulacra are petaloid. The plates of the apical system are situated about the centre of the aboral surface, sometimes surrounding a centro-dorsal plate; sometimes more or less fused together. The spines are exceedingly fine and hair-like, those of the dorsal surface ciliated. Sphæridia and pedicellariæ are usually present, but clavulæ are absent. The dorsal podia are flattened and respiratory. An "Aristotle's lantern" with teeth is present, as in the globular forms, but often much simplified.

In the **Holothuroidea** the body is more or less elongated in the direction of the axis joining mouth with anus, which are placed at opposite (*anterior* or *oral*, and *posterior aboral* or *anal*) extremities of the body. The shape is sometimes completely cylindrical, sometimes five-sided; in many there is more or less dorso-ventral compression, and the dorsal and ventral surfaces may differ greatly from one another. A flattened sole-like ventral surface bearing the three rows of tube-feet of the trivium is, as already stated, often distinguishable: it is most distinctly developed in *Psolus* and allied genera. In some Holothuroids the surface is enclosed in an armour of close-fitting plates; but in the vast majority the body-wall is comparatively soft, being strengthened merely by a great number of minute ossicles of a variety of shapes. In *Synapta* (Apoda) numerous minute anchor-like spicules, each connected with a latticed plate, project from the surface, and cause the animal to adhere to soft bodies with which it comes in contact. In the pelagic *Pelagothuria* and in *Rhabdomolgus*, as

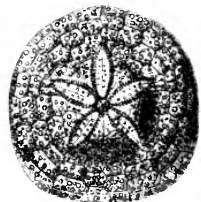

FIG. 346.—*Clypeaster subdepressus*, view of aboral surface showing the petaloid ambulacra. (From Hertwig's *Lehrbuch*.)

already mentioned, there are no hard parts of any kind. Around the mouth is a whorl of *tentacles*—*pinnate*, shield-shaped, or arborescent. The tube-feet are sometimes entirely absent. When present they are usually uniform in character throughout, and may be arranged in five regular longitudinal rows, or scattered over the entire surface. Sometimes, as has already been stated in the account of *Colochirus*, the tube-feet of the dorsal and even some of those of the ventral surface may assume the form of *papillæ*. In the *Elesiopoda* the tube-feet of the dorsal surface are remarkably modified, taking the form of greatly elongated processes.

In the **Crinoidea** the general shape is that which has been described in the case of the Feather-star—star-like, with a *central disc* and a series of radiating *arms*, which usually branch dichotomously. In the stalked forms (Fig. 347) a *stalk*, consisting of a row of elongated ossicles connected together by bundles of ligamentous fibres, attaches the animal to the sea-bottom. Along

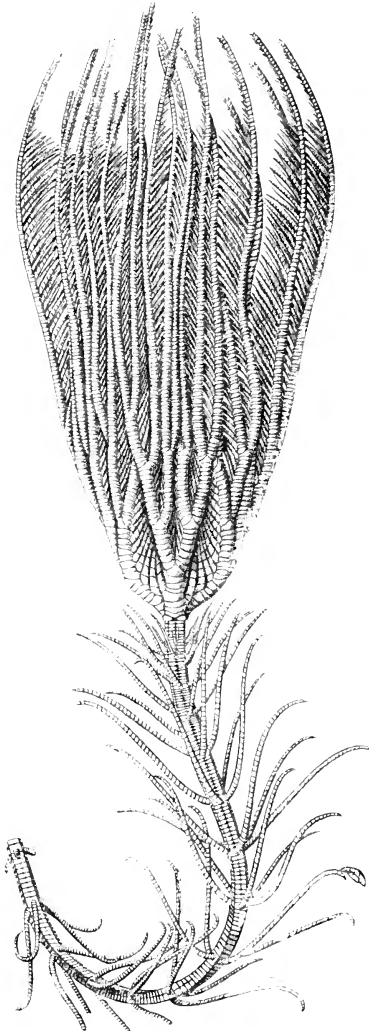

FIG. 347.—*Metacrinus interruptus*.
(After P. H. Carpenter.)

some of the joints of the stalk are usually arranged a number of slender, many-jointed appendages—the *cirri*. At its base the stalk usually breaks up into a number of root-like processes; distally it becomes continuous with the central disc. The ossicles forming the skeleton of the central disc are the *basals* and the *radials*: with the latter articulate externally the *brachials*, a single row of which gives support to each of the arms and its branches, while similar rows of smaller ossicles support the pinnules—the lateral appendages which fringe the arms in a double row. In the free forms the stalk is absent in the adult condition, though present in the larva, and from its terminal ossicle and other neighbouring plates is formed by coalescence a plate—the *centro-dorsal ossicle* of the disc. To the centro-dorsal ossicle are attached whorls of many-jointed, slender, curved *cirri*.

The mouth in all the Crinoidea, with one exception (*Actinometra*), is situated in the centre of the oral (upper) surface, and the anus in all, with the same exception, is eccentric and inter-radial. Running outwards from the mouth are a series of very narrow *ambulacral grooves*, one of which extends along the oral surface of each arm, giving off branches to the arm-branches and to the pinnules. Bordering the ambulacral grooves and their branches are a pair of rows of short tubular *tentacles*, which correspond morphologically with the tube-feet of the other classes, but are devoid of the terminal suckers, and are not locomotor, but probably sensory and respiratory in function.

The **cœlome** in the Echinoderms is a wide cavity of enterocœlic origin lined by a ciliated cœlomic epithelium and containing a corpusculated fluid. Prolongations of it pass out into the rays, and, in the Ophiuroidea and Asteroidea, between the layers of the body-wall. In the Crinoidea it contains numerous strands of connective tissue. Special organs providing for respiration and excretion through the medium of this fluid are the *dermal branchia* or *papulae*, the *Stewart's organs*, and the *respiratory trees*. The first of these, which are confined to the Asteroidea and Echinoidea, have been described in the accounts of the Starfish and Sea-urchin. In most Asteroidea they occur only on the dorsal surface, but in some forms they are present on the ventral surface as well. In some of the Echinoids the place of dermal branchiæ in providing for the respiration of the compartment of the cœlome enclosing Aristotle's lantern (lantern-cœlome) is taken by *Stewart's organs*, simple or arborescent bodies which project inwards from the peristome. The respiratory trees are referred to below in connection with the enteric canal.

Some reference has already been made, in describing the general form of the body, to the **ambulacral system of vessels**. A ring-like *circum-oral vessel* (*ring-vessel*) in nearly all cases sends off a series of *radial* branches, one passing along each of the rays or

ambulacral areas and giving off branches to the ampullæ of the tube-feet or to the tentacles. In most of the Holothuroidea branches pass forwards to the circlet of shield-shaped or branched oral tentacles, and in some cases there are vesicles or *ampullæ* at their bases. In the Apoda, in which tube-feet are wanting, radial vessels are also absent, and the vessels to the tentacles come off directly from the ring-vessel. In all the classes, except Crinoidea, one or more bladder-like appendages—the *Polian vesicles*—are in most cases connected with the ring-vessel. The *racemose vesicles*, or *Tiedemann's vesicles* (p. 377), are characteristic of the Asteroidea. In all, except the Crinoidea and the majority of the Holothuroidea, there is a communication between the ring-vessel and the surrounding water through the *madreporic canal*. In the Asteroidea, and in *Cidaris* among the Echinoidea, the wall of this tube is strengthened by numerous calcareous ossicles. In the Asteroidea, Ophiuroidea, and Echinoidea the communication with the exterior is through the madreporite. The fine pores perforating the madreporite and placing the madreporic canal in communication with the exterior, and the madreporic canal itself, are lined with strong cilia which move so as to drive a strong current inwards—the effect being to keep all parts of the ambulacral system in a condition of turgidity. In the few Holothuroids in which such a communication exists (*Elasipoda*) there is usually a simple opening, but sometimes a number of pores crowded together. In the remainder of the Holothuroidea the distal end of the madreporic canal, or canals, lies free in the interior of the body-cavity, with which it is placed in communication by a number of perforations. In the Crinoidea there is no madreporic canal; but the ring-vessel is placed in communication with the cœlome by means of a system of ciliated *water-tubes*, while the cœlome communicates with the exterior through a number of minute *water-pores*, which perforate the oral body-wall. The fluid contained in the ambulacral system is similar to that in the cœlome, and contains similar corpuscles. In one Ophiuroid, however, the ambulacral system contains corpuscles coloured red with hæmoglobin. Tiedemann's vesicles appear to have the function of manufacturing the corpuscles.

It cannot be definitely stated that a **blood-vascular system** exists in the Echinoderms. But two systems have been regarded as playing the part of blood-vessels—the *perihæmal* system and the *hæmal* system. Neither of these systems comprises vessels with contractile walls, and there is no definite circulation of the contained fluid. The perihæmal or, as it is sometimes termed, pseudohæmal system, is present in all the classes of the phylum. When typically developed (Asteroidea, Ophiuroidea) it consists of a ring-like circum-oral vessel or sinus and five radial vessels given off from it, together with an axial sinus and aboral ring-vessels. These "vessels" are channels with a definite epithelial lining,

and are of the nature of specialised parts of the cœlome, from which they are developed. In Asteroidea and Ophiuroidea the radial and ring-vessels, which lie between the corresponding parts of the ambulacral and epidermal nervous systems, are divided into two parts by a longitudinal septum, vertical in the radial, oblique in the ring-vessel. The axial sinus is nearly vertical in direction and partly encloses the axial organ in the way already described (p. 378). At its oral end it opens into the inner division of the circum-oral vessel: at its aboral end it opens into, or becomes closely applied to, the aboral vessel, which is in the form of a ring giving off radial branches towards the gonads: it may also communicate aborally with several of the pore-canal of the madreporite, and opens into the madreporic canal itself. In the Echinoidea the arrangement of the parts is modified in certain important respects. An oral ring-sinus is absent unless it be represented by the lantern-cœlome. The radial vessels of the system do not open orally into the lantern-cœlome: aborally they also terminate blindly, not opening into the aboral ring-sinus. The axial sinus is largely encroached upon by the axial organ: it terminates blindly at the oral end; aborally it communicates with the madreporic canal and is not connected with the aboral sinus. In the Holothuroidea there are five radial sinuses extending through the ambulacral areas between the superficial radial nerve and the radial ambulacral vessel, ending blindly aborally and opening orally into an oral ring-sinus. There is no axial sinus. In the Crinoidea the perihæmal system is greatly reduced, though representatives of the radial sinuses are present in the same situation as in the other classes.

The general disposition of the **lacunar** or so-called **hæmal system** in the Asteroidea has been described in the account given of the structure of the Starfish (p. 373). Save for certain minor alterations which are involved in the change in the position of the madreporite, the system is arranged in the Ophiuroidea on the same plan as in the Asteroidea. In the Echinoidea there is an oral ring giving off five radial strands which in the greater part of their course occupy the typical position between the superficial radial nerve and the radial ambulacral vessel; aborally they terminate blindly. A gastro-intestinal system given off from the oral ring is highly developed, and there are an axial plexus in the axial organ and an aboral ring, with strands passing to the gonads, as in the Asteroidea. In the Holothuroidea there is an oral ring with radial strands, and a well-developed gastro-intestinal system. In the Crinoidea this system of lacunæ is highly developed and complicated in arrangement.

Whatever be its functions, this system is not a system of blood-vessels. It is made up of strands of a kind of gelatinous connective tissue, with many leucocytes, permeated in a very irregular way by minute lacunæ without definite walls. The great develop-

ment of the gastric and intestinal branches of this system in some (Echinoids, Holothuroids) lends support to the view that its main functions may be connected with the absorption and distribution of nourishment.

The **axial organ** (genital stolon) of the Echinodermata is closely connected both with the perihæmal and hæmal systems. Its general structure and relations in the Asteroidea have already been described (p. 378). In the Ophiuroidea there is a close correspondence with the Asteroidea, the chief differences being such as are involved in the change in the position of the madreporite from the aboral to the oral surface, and the resulting change in the direction of the madreporic canal and associated axial sinus and axial organ. In the Echinoidea the essentials are the same; but the axial organ has grown round the axial sinus so as to enclose it completely.

The **enteric canal** varies in the five classes more than any of the other systems of organs. It is a simple tube in the Holothurians and Echinoids, passing spirally through the body from the mouth at the oral pole to the anus at the opposite pole. In most of the latter group a complex masticatory apparatus with five teeth—the so-called “lantern of Aristotle”—is situated at its anterior extremity; the corresponding region in the Holothurians is surrounded by a circlet of ossicles, which protect the nervous and vascular rings and into which the longitudinal muscles of the body-wall are inserted.

In the Echinoidea there is a tubular cæcum, the *siphon*, connected with the intestine. In the Holothurians the so-called “respiratory trees” (absent in the Elaspoda and the Apoda) are branched appendages—usually two in number, sometimes single—of the cloaca or posterior wider portion of the intestine, and the “Cuvierian organs” are simple filiform glandular tubes, also connected with the cloaca.

The functions of the siphon and of the respiratory trees have already been referred to in the accounts of Echinus and Cucumaria. The Cuvierian organs, which occur only in a limited number of Holothurians, correspond to undivided basal branches of the respiratory trees: they are defensive organs, the animal when attacked throwing out numbers of these filaments, the secretion of which is very viscid and assumes the character of slender threads which may have the effect of entangling and hampering the assailant; but they may also have an excretory function.

In the Crinoidea the alimentary canal is simply a coiled tube with both mouth and anal opening on the same (actinal) surface of the body. In the Ophiuroids the central mouth leads into a simple sac giving off short diverticula, and there is no anal aperture. In the Asteroidea the alimentary canal is more complex than in the other classes. The stomach is divided, as already

described in the account of the examples, into two portions, the cardiac and the pyloric, the former giving off five large rounded radial diverticula—the cardiac pouches or cardiac cæca, and the latter five pairs of very long branched diverticula—the pyloric or hepatic cæca. The intestine is short and conical, and opens, in all but a few, by an anal aperture. In some Asteroidea (as in *Anthenea*, Figs. 313 and 315) the intestine has connected with it a system of five elongated bifurcated inter-radial intestinal cæca; in others (as in *Asterias*, Fig. 311) these are represented only by two or three lobed diverticula. In one member of the class there are also ten cæca connected with the œsophagus.

In the **nervous system** of the Echinodermata three distinct parts, the relative development of which differs in the different classes, are to be recognised. These are the *epidermal* or *superficial*, the *deep*, and the *cœlomic* or *aboral*. The epidermal system is well developed in all the classes: its principal parts are a circum-oral nerve-ring and radial branches, but a plexus of nerve-fibres with occasional nerve-cells extends from it through the epidermis. In the Ophiuroids the radial nerves and the ring nerve are similar in their arrangement to what is to be observed in the Asteroids, but are more deeply placed, being covered over by the investing calcareous plates. The deep-lying nervous system is absent in the Crinoidea, very feebly developed in the Echinoidea, but well developed in the Asteroidea, Ophiuroidea, and Holothuroidea. Its general arrangement has already been described in the account of the Starfish. The aboral system is best developed in the Crinoidea and is absent altogether in the Holothuroidea.

The **sexes** are distinct in all the Echinoderms, with one or two exceptions; but there is very rarely any trace of sexual dimorphism. *Asterina gibbosa*, the Starfish the development of which has been described (p. 381), is one of the exceptional hermaphrodite forms; the young animals of this species are male, producing sperms, but at a later stage they become female and produce only ova. In the family Synaptidæ of the Apoda there are also numerous examples of hermaphroditism, the animal at first producing ova, later only sperms. In *Amphiura squamata*, an Ophiuroid, both ovaries and testes are present at once. The gonads, ovaries or testes as the case may be, are branching bodies, inter-radial in position, and usually in pairs. In the Asteroidea in general there are five pairs, the ducts from which open usually on a special plate on the aboral surface, but in one or two species on the oral surface. In *Pentaceros* and some other genera the gonads are more numerous. In the Echinoidea there are five ovaries or testes, the five ducts of which open on the genital plates of the apical system. In the Ophiuroidea there are ten pairs of gonads or groups of gonads, a pair in the walls of each of five pairs of *genital bursæ*, which open on the exterior by slits on the oral surface close to the mouth. In the Holothuroidea

there is only a single branched gonad, sometimes imperfectly divided into two, with a duct opening on the dorsal surface not far from the mouth. In the Crinoidea the ovaries and testes occupy a remarkable position, being situated in the dilated bases of the pinnules; but, as in the other classes, they are connected by means of a *genital rachis* running through the arm with a centrally situated *genital stolon* (*axial organ*).

Development and Metamorphosis.—A few of the members of each class of Echinoderms are viviparous, in the sense that the development of the young takes place in some sheltering cavity, or *brood-pouch*, on the surface of the body of the parent. But in most, development takes place externally, and the larvæ are free-swimming. The ovum in all undergoes regular and nearly equal segmentation, resulting in the formation of a ciliated blastula, which becomes invaginated so as to form a typical gastrula, like that of some Cœlenterata. The invaginated cells form the lining membrane (the endoderm layer) of an internal cavity—the primitive alimentary cavity or archenteron; the enclosing cells form the ectoderm; between the endoderm and ectoderm, and derived from the former, appear the cells of the mesoderm or middle layer. From the archenteron is given off a hollow outgrowth, the *enterocœle*, from which are derived the body-cavity with its enclosing peritoneal membrane, and the vessels of the ambulacral system with their various appendages. In the Crinoidea the vesicle destined to form the ambulacral system is developed independently of the cœlomic vesicles destined to form the body-cavity. A canal opening on the exterior by a dorsally situated opening, the *dorsal pore* (sometimes double), is formed by invagination from the surface ectoderm, and comes into relation with a canal arising as an outgrowth from the rudimentary ambulacral system to form the foundation of the madreporic canal of the adult. In the Crinoidea five dorsal pores and five canals are developed, but the two sets of structures do not enter into direct communication (see p. 399).

The part of the enterocœle (*hydrocœle*) destined to give rise to the ambulacral system, at first rounded, becomes compressed, and subsequently divided round the border into five lobes. Each of these lobes grows outwards to become developed subsequently into one of the five *radial ambulacral vessels* of the Echinoderm; the central part of the hydrocœle gives rise to the *ring-vessel* surrounding the œsophagus.

The cilia, which at first (in the gastrula stage) covered the surface of the larva uniformly, become restricted to a *peri-oral* band (Fig. 348, 1, 2 *por*) surrounding a concave area on which the mouth opens. A smaller *adoral* band (1, 7, *aor*) in the interior of the mouth has the function of attracting nutrient particles. The peri-oral band undergoes characteristic changes in the different classes, and the form of the larva at the same time becomes

modified by the formation, except in the Crinoidea, of variously arranged processes along its course. The resulting larva, *echinopædium* or *dipleurula*, always exhibits marked bilateral symmetry. It has a pre-oral lobe on which an apical plate comparable to that of the trochophore (p. 316) may be developed.

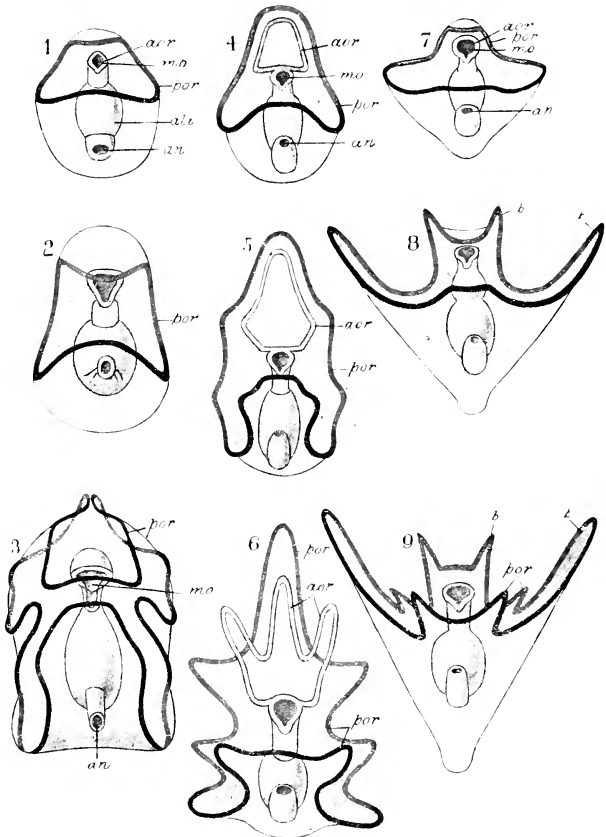

FIG. 318.—Diagrams of the development of the larva of **Echinoderms**. 1. Primitive form of Echinoderm larva; 2 and 3. Development of an *auricularia* (Holothuroidea); 4, 5, and 6. Development of a *bipinnaria* (Asteroidea); 7, 8, and 9. Development of a *pluteus* (Echinoidea and Ophiuroidea). *acr*, in 1 and 7, adoral band of cilia, in 4, 5 and 6, pre-oral loop; *ali*, alimentary canal; *an*, anus; *b*, *b*, processes or arms; *mo*, mouth; *por*, in 1, 2, 7 and 9, peri-oral ciliated band and processes, in 3, 4, 5 and 6, post-oral loop. (From Leuckart and Nitsche's Diagrams.)

In the Asterozoa the larva is either a *bipinnaria* (Fig. 348, 4 to 6) or a *brachiolaria*. The former has a series of bilaterally arranged processes or arms; the latter has, in addition, three processes not developed in the course of the ciliated band and used for fixation. The larva of *Asterina*, the development of which has been described and illustrated on pp. 380-385, is a greatly modified bipinnaria with the pre-oral lobe large and eventually serving as a stalk, and the band of cilia confined to the edge of the larval organ and devoid of the bilateral processes of the normal bipinnaria. In at least one form the bipinnaria, developed in a brood-pouch, adheres to the parent by means of the pre-oral lobe which takes the form of a short stalk. In general the bipinnaria is

free-swimming and has a large pre-oral lobe, the part of the ciliated band borne on which becomes separated off as a *pre-oral loop* (*aor*) from the rest or *post-oral loop* (*por*). In the course of both of these loops are the variously-arranged paired processes. In both the Ophiurozoa and the Echinozoa (Fig. 348, 7 to 9) the larva has the form which is known as the *pluteus*. The *pluteus* has a number of slender arms directed forwards and supported by a skeleton of delicate calcareous rods: the pre-oral lobe is reduced and the ciliated band is undivided. The larva of the Holothurozoa, the *auricularia* (2 and 3), has a number of short processes developed in the course of the ciliated bands; subsequently, in the *pupa* stage, the ciliated bands become broken up into a series of ciliated hoops encircling the body. Of the

Crinozoa the development of *Antedon* alone is known. Blastula and gastrula stages occur as in the Starfish, but the history of the archenteron and its diverticula is widely different, though the outcome is the same—viz., the differentiation of a primitive enteric canal, an anterior coelome, from which a hydrocoele becomes separated off, and a pair of coelomic sacs. The larva (Fig. 349) becomes barrel-shaped, and the pre-oral lobe, which is not very conspicuous, develops an ectodermal thickening with a tuft of sensory cilia. The vibratile cilia on the surface are arranged in five transverse bands (*I-V*). Between the second and third of these is a wide shallow depression, the vestibule or stomodæum (1), which does not communicate with the mouth. After remaining in the free condition for a short time, the larva

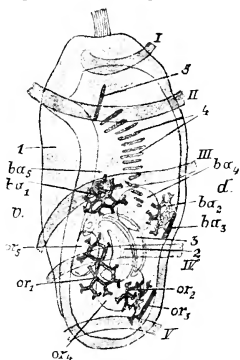

FIG. 349.—Free-swimming larva of *Antedon*, from the left side. *I-V*, ciliated bands; *ba*₁ to *ba*₅, the five basals; *or*₁ to *or*₅, orals; 1, vestibule; 2, intestinal vesicle; 3, right enterocoele; 4, calcareous joints of the stalk; 5, pedal plate. (From Lang, after Seeliger.)

(Fig. 350) fixes itself by means of the pre-oral lobe, which elongates into a stalk (11), the cilia meanwhile being lost, and the apical plate absorbed. The vestibule becomes closed, and a solid rudiment of the adult œsophagus arises in close apposition with it. Round

the œsophagus the hydrocœle grows in the form of a ring. The vestibule (5) with the œsophagus and hydrocœle are rotated so as to come to lie at the free extremity. The radial canals first appear as five tentacles which at first project into the cavity of the vestibule, and subsequently—when the latter opens out, as it soon does—on the exterior. The œsophagus (8), meanwhile, has become completed, and the mouth pierces the bottom of the now open vestibular cavity. The arms appear as five processes which soon bifurcate: the five radial canals become applied to them and undergo a corresponding division. The first plates are formed while the larva is still in the free condition; in the fixed condition they undergo further development, and extend into the arms as they grow. After about six months this *pentacrinoid* larva becomes free by the absorption of the stalk and develops into the adult *Antedon*.

In the transition from the bilateral larva — pluteus, bipinnaria, brachiolaria, or auricularia — to the radial adult there is a marked *metamorphosis*. As the adult form is developed on one side of the larva, with its principal axis at right angles to that of the latter, the larval arms or processes become absorbed. In the *Holothuroidea* and *Ophiuroidea* all the organs of the larva are carried on into the adult; in the *Asteroidea* and *Echinoidea* the larval mouth and œsophagus are abolished and a new permanent mouth and œsophagus formed as a fresh invagination from the surface. In the very limited number of *Echinoderms* which are viviparous there is no such

marked metamorphosis; but even in these the larva is at first distinctly bilateral in its symmetry.

Ethology, etc.—The *Echinodermata* are without exception¹ inhabitants of the sea. In the adult condition the majority creep

¹ One species of *Synapta* is said to inhabit brackish water.

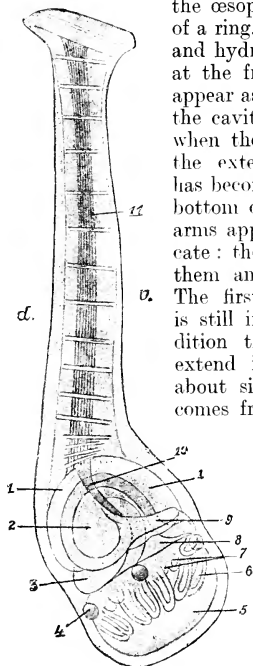

FIG. 350.—Stalked larva of *Antedon*, from the right side; calcareous plates not represented. 1, right coelomic sac; 2, enteric cavity; 3, left coelomic sac; 4, sacculi; 5, vestibule, still closed; 6, primary tentacles; 7, secondary tentacles; 8, œsophagus; 9, rectum; 10, axial organ; 11, fibrous strands in the stalk. (From Lang, after Seeliger.)

on the sea-shore or on the sea-bottom, the stalked Crinoids being exceptional in their permanently attached condition; but the larvæ of the great majority are *pelagic*—*i.e.* live swimming in the upper strata of the ocean.

Echinoderms inhabit all depths of the sea, ranging from the shore between low and high water limits to the greatest depths. Members of all the classes are found at all depths; but the stalked Crinoids and the Elasipoda among the Holothuroidea are virtually confined to the deepest waters of the ocean, only one genus of the former and one species of the latter occurring in comparatively shallow water. Echinoderms are found in the seas of all parts of the globe. Like the majority of marine invertebrate groups, the phylum is more abundantly represented, as regards the number of genera and species as well as of individuals, in the warmer regions; the Crinoidea, the Holothuroidea and the Echinoidea are all much more abundant in tropical and warm temperate seas than in colder latitudes.

Echinoderms are of gregarious habits, large numbers of the same species frequently being found closely associated together in a comparatively narrow area. The movement of locomotion in the Starfishes is, as previously described (p. 370), a slow creeping one, through the agency of the tube-feet: the same holds good of the Echinoidea and those of the Holothuroidea that possess tube-feet (*Pedata*). The footless Holothurians (*Apoda*, such as *Synapta*) creep along with the help of the tentacles. Most of the Ophiuroids move by lateral flexions, sometimes sluggish, sometimes remarkably rapid, of the arms. The Comatulæ, on the other hand, swim along by the flexion and extension of the pinnate arms propelling them through the water. Many Asteroids, Ophiuroids, and Echinoids bury themselves in sand or mud; others creep into narrow fissures in rock or coral. Movements of *manducation* are performed by the tentacles in the Holothurians: in the Starfishes the mouth papillæ are separated from one another and the cardiac part of the stomach everted in order to enfold the prey, often of relatively large size. In those Echinoidea that possess a lantern of Aristotle there are very powerful and efficient movements of mastication. On the whole, as might be expected from the comparatively highly developed muscular and nervous systems, the co-ordination of movement is very much more complete in the Echinodermata than in the groups already dealt with.

A remarkable characteristic of the Echinoderms is the faculty of *self-mutilation* which many of them possess, together with the capacity for replacing parts lost in this way or by accidental injury. This is most marked in many Ophiuroids, some Asteroids, and some Holothurians, and does not occur at all among the Echinoids. Many Brittle-stars and some Starfishes, when removed from the water, or when molested in any way, break off portions of

their arms piece by piece until, it may be, the whole of them are thrown off to the very bases, leaving the central disc entirely bereft of arms. A central disc thus partly or completely deprived of its arms is capable in many cases of developing a new set; and a separated arm is capable in some instances of developing a new disc and a completed series of arms. In some Starfishes (Ophiuroids and Asteroids) a process of separation of the arms and their development into complete individuals frequently occurs altogether independently of injury, and seems to be a regular mode of reproduction in these exceptional cases. Many Crinoids, also, readily part with their arms when touched and are able to renew them again; and some, at least, are capable of renewing the visceral sac of the central disc when it has become accidentally removed.

In the case of many Holothurians it is the internal organs, or rather portions of them, that are capable of being thrown off and replaced—the œsophagus, or the cloaca with the Cuvierian organs, or the entire alimentary canal, being ejected from the body by strong contractions of the muscular fibres of the body-wall, and in some instances, at least, afterwards becoming completely renewed.

Four out of the nine classes of the phylum Echinodermata—the Cystoidea, Blastoidea, Edriasteroidea, and Carpoidea—are represented only by fossil forms; and these are found only in rocks of the older (Palæozoic) formations, no representatives having survived to more recent times. Of the five classes that have living members, one, the Crinoidea, was very much more abundantly represented in the older geological periods than it is at the present day, the remains of stalked Crinoids forming great beds of limestone of Silurian to Carboniferous age: the free Comatulæ only appeared at a much later period. The other classes, or at least the Echinoidea, Asteroidea, and Ophiuroidea, were represented at a very early period by forms not very widely different from those now living; but the earliest Echinoids were peculiar in having the number of rows of plates variable, and in the plates overlapping one another. The Holothuroidea, owing to their comparatively soft integument, were less fitted to leave any remains in the form of fossils, and it is not till we come to the Mesozoic Period that undoubted traces of their existence are found.

Affinities.—The presence of radial symmetry was formerly regarded as involving a near relationship with the Cœlenterata, which were grouped with the Echinodermata under the comprehensive class-designation of *Radiata* (see section on the History of Zoology). But, leaving out of account the presence of a bilateral symmetry underlying and partly concealed by the radial, we are led by a study of the anatomy of the various systems of organs to the conclusion that the Echinoderms are in no way closely or directly related to the Cœlenterates. One very great and very important

difference between the two phyla consists in the presence in the Echinodermata of an extensive cœlome or body-cavity lined by mesodermal epithelium between the alimentary canal and the body-wall. In addition to this the Echinoderms are characterised by the possession of highly elaborated systems of organs—alimentary, vascular, and nervous—such as occur in none of the Cœlenterates, all of which exhibit extreme simplicity in their internal structure. A further point of difference, not perhaps of so much importance, is the absence in the Echinoderms of any tendency to form colonies of zooids by asexual multiplication by means of buds: all Echinoderms are simple, *i.e.* non-colonial, animals, and each of them is developed, save in certain very exceptional cases, as a result of a sexual process from an impregnated ovum. In spite, then, of the radial symmetry, we are forced to the conclusion that the Echinodermata are not more nearly related to the Cœlenterata than to some of the groups of Worms. They are, in fact, a singularly isolated group, and we look in vain among the known members, living and fossil, of other phyla for any really close allies. The intermediate forms—whatever they may have been like—between the Echinoderms and other groups have become extinct, and have left no remains in the form of fossils, or such remains have not yet been discovered. So difficult has it been found to connect the Echinoderms with other animal types that it has even been proposed to regard an Echinoderm as a radially arranged colony of zooids connected together centrally, each ray being a zooid equivalent to an entire simple worm-like animal. But the history of the development is entirely at variance with such a view.

Whatever may have been the group of animals from which the Echinodermata were developed, there is every probability that it was a group with bilateral and not radial symmetry. The radial symmetry is evidently, as has already been pointed out, of a secondary character; it is only assumed at a comparatively late period of development, and even in the adult condition it does not completely disguise an underlying bilateral arrangement of the parts. Accordingly, within the phylum itself, it is reasonable to regard those classes as the more ancient which have the radial symmetry less completely developed. Again, the free condition which characterises all existing Echinoderms, with the exception of a few Crinoids, is probably less primitive than the attached, since in other phyla the radial symmetry is co-ordinated with, and seems to be developed on account of, a fixed, usually stalked condition. Probably, then, stalked Echinoderms were the progenitors of the existing free forms, and these were preceded by primitive free forms with pronounced bilateral symmetry. It appears to be most probable that this ancestral form possessed the most essential features of the *dipleurula* larva (p. 422); *i.e.*, that it was a bilaterally symmetrical form with a pre-oral lobe, simple

alimentary canal with mouth on ventral surface and anus at posterior end; that it had a coelome, originally developed from the archenteron of the gastrula; and that it had a band of strong cilia running around the concave ventral surface. Such a dipleurula-like form became converted, it is supposed, into a fixed form, such as that represented by some of the extinct class of the Cystoidea. The fixation must be supposed to have become effected through the medium of the pre-oral lobe, and further changes must have involved the shifting of the mouth to about the middle of the free surface. From this primitive Cystoid, thus regarded as the most primitive of all known Echinoderms, the remaining classes, both fixed and free, might have been derived by some such order of succession as that indicated in Fig. 351.

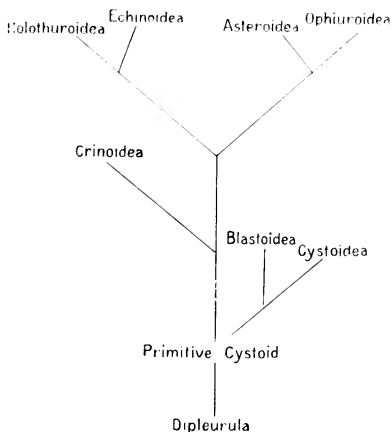

FIG. 351.—Diagram to illustrate the relationships of the classes of the Echinodermata.

According to another view, however, the most primitive of existing Echinoderms are *Synapta* and its allies (Holothuroidea apoda). The other Holothuroids are supposed, according to this conception of the relationships of the various classes, to have been derived from a *Synapta*-like ancestor. From the primitive stock of the Holothuroids is supposed to have been derived a form which gave origin to all the stalked classes. From this ancestral stalked Echinoderm, again, the remainder of the free classes—the Echinoidea, Asteroidea, and Ophiuroidea—are regarded as having been descended.

Possible relationships between the Echinodermata and the Chordata will be referred to in the discussion of the affinities of the latter phylum.

SECTION X

PHYLUM ANNULATA

THE phylum Annulata comprises six classes of Worms—the *Chætopoda* or Earthworms and marine Annelids, with the *Myzostomida* and *Echiurida*, the *Archi-Annelida*, the *Sipunculoidea*, and the *Hirudinea* or Leeches. These in general have the elongated body divided externally into a number of rings, which represent a division of the internal parts into a series of segments or metameres. There is usually an extensive cœlome, and there is in most cases a system of blood-vessels. The nervous system consists in most cases of a cerebral ganglion, œsophageal connectives, and a double ventral nerve-cord, which is segmented into a series of ganglia. The organs of excretion are in the form of metamericly arranged pairs of tubes, the *nephridia* or *segmental organs*, closed internally or leading from the cœlome to the exterior; and united with these, or distinct from them, are a series of paired ducts, the *cœlomoducts*, for the passage outwards of the reproductive elements.

CLASS I.—CHÆTOPODA.

The Chætopoda, comprising the Earthworms, Fresh-Water Worms, and Marine Annelids, are Worms the body of which, unlike that of a Flat-worm or a Round-worm, is made up of a series of more or less completely similar segments or *metameres*, each containing a chamber or compartment of the body-cavity and a section of the alimentary canal and other organs. At the sides of each are typically a pair of muscular processes, the *parapodia*, which do duty as limbs, bearing bundles of *setæ* (*chætæ*) or bristles, and usually also certain tactile appendages, the *cirri*. There is an extensive cœlome, incompletely divided into a series of chambers corresponding to the segments by a series of muscular partitions which act also as mesenteries, being attached internally to the alimentary canal. The latter extends throughout the length of the body; the intestine is usually constricted, the constrictions being either segmental, *i.e.* opposite the middle of the segments, or inter-segmental, *i.e.* opposite the intervals between the segments. There is a well-developed blood-vascular system

in the majority of the Chætopoda, and organs of respiration in the shape of gills or branchiæ are usually developed. The excretory organs are in the form of segmentally arranged pairs of tubes, the *nephridia*. The nervous system consists of a bilateral principal ganglion or brain situated in the prostomium, and a double chain of ganglia extending throughout the body. The sexes are in some distinct, in others united. When a definite larval form occurs it is a *trochophore*.

1. EXAMPLES OF THE CLASS.

a. *Nereis dumerilii*.¹

General External Features.—Various species of *Nereis* occur abundantly between tide-marks on the sea-shore, under stones,

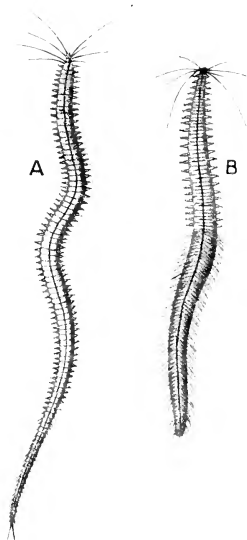

FIG. 352.—*Nereis dumerilii*, natural size. A, *Nereis* phase; B, *Heteronereis* phase. (After Claparède.)

and among sea-weed, in all parts of the world. The worm varies considerably in colour even in the same species, the differences being partly due to differences in the stage of development of the sexual elements. In *N. dumerilii* the prevailing colour is some shade of violet, with a blush of red in the more vascular parts due to the bright red colour of the blood. In shape (Fig. 352) the body, which may be about 7 or 8 centimetres in length, is long and narrow, approximately cylindrical, somewhat narrower towards the posterior end. A very distinct head, bearing eyes and tentacles, is recognisable at the anterior end; the rest is divided by a series of ring-like narrow grooves into a corresponding series of *segments* or *metameres*, which are about eighty in number altogether; and each of these bears laterally a pair of movable muscular processes called the *parapodia*, provided with bundles of bristles or *setæ* (*chaeta*). The head (Fig. 355) consists of two parts, the *prostomium* (*præst*) and the *peristomium* (*perist.*). The former bears on its dorsal surface four large rounded *eyes*, in front a pair of

¹ Though *Nereis dumerilii* is here named as the example, and the majority of the figures refer specially to that species, the description given would apply almost equally well to a considerable number of species of the genus.

short cylindrical *tentacles* (*tent*), and further back a pair of somewhat longer stout appendages or *palpi* (*palp*). The *peristomium*, which has some resemblance to the segments of the body, though wanting the parapodia, bears laterally four pairs of long, slender, cylindrical tentacles (*perist. tent*): on its ventral aspect is a transversely elongated aperture, the *mouth*. The segments of the body differ little in external characters from one another throughout the length of the worm. Each bears laterally a pair of parapodia, which in the living animal are usually in active movement, aiding in creeping,

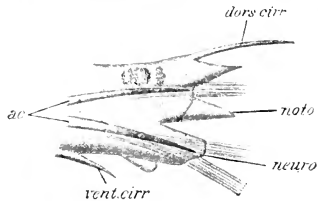

FIG. 353. *Nereis dumerilii*. A single parapodium, magnified: *ac.* aciculum; *dors. cirr.* dorsal cirrus; *neuro.* neuropodium; *noto.* notopodium; *vent. cirr.* ventral cirrus. (After Claparède.)

or acting as a series of oars for propelling it through the water. When one of the parapodia (Fig. 353) is examined more attentively it is found to be *biramous*, or to consist of two distinct divisions—a dorsal, which is termed the *notopodium* (*noto*), and a ventral, which is called the *neuropodium* (*neuro*). Each of these is further subdivided into several lobes, and each bears a bundle of setæ. Each of the bundles of setæ is lodged in a sac formed by invagination of the epidermis—the *setigerous sac*—and is capable of being protruded or retracted and turned in various directions by strands of muscular fibres in the interior of the parapodium. In each bundle there is, in addition to the ordinary setæ, a stouter, straight dark-coloured seta (*ac.*), the pointed apex of which projects only a short distance on the surface; this is termed the *aciculum*. The ordinary setæ (Fig. 354) are exceedingly fine, but stiffish, chitinous rods, of which two principal kinds are recognisable: both have a terminal *blade* articulating with the main *shaft* of the seta by a distinct joint; but in the one variety the shaft of the seta is finer than in the other, and the terminal blade long, slender, and nearly straight, whereas in the other variety it is

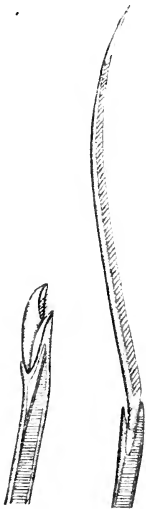

FIG. 354.—*Nereis dumerilii*. Setæ highly magnified. (After Claparède).

short and slightly hooked. On the dorsal side of the parapodium is a short cylindrical, tentacle-like appendage, the *dorsal cirrus* (Fig. 353, *dors. cirr*), and a similar, somewhat shorter appendage,

the *ventral cirrus* (*vent. cirr*), is situated on its ventral side. The last segment of the body, the *anal segment*, bears posteriorly a small rounded aperture, the *anus*; this segment is devoid of parapodia, but bears a pair of appendages, the *anal cirri*, similar in character to the cirri of the ordinary segments, but considerably longer.

On the ventral surface, near the bases of the parapodia, there is in each segment a pair of very fine apertures, the openings of the nephridia.

The *enteric canal* is a straight tube running throughout the length of the body from the mouth to the anus. Between the outer surface of this tube and the inner surface of the wall of the body is a considerable space—the *cœlome*, *body-cavity*, or *peri-visceral cavity*—filled with a fluid, the *cœlomic fluid*, containing amœboid corpuscles. The walls of the cœlome (Fig. 357) are lined with a thin membrane, the *peritoneum* or *cœlomic epithelium*, of which the outer layer—that lining the body-wall—is the *parietal layer* (*par. peri*), that covering the outer surface of the alimentary canal the *splanchnic* or *visceral layer* (*visc. peri*). The space is divided by a series of transverse partitions or *septa* passing inwards from the body-wall to the wall of the alimentary canal opposite the grooves between the segments, and thus dividing the cœlome into a series of chambers, each of which corresponds to one of the segments. These partitions are not complete, spaces being left around the alimentary canal and elsewhere through which neighbouring chambers communicate.

The mouth leads into a wide cavity, the *buccal cavity*, continued back into a *pharynx* (Fig. 356, *ph*). These two chambers extend through the peristomium and the first to the fourth segments of the body. They are lined with a tolerably thick cuticle, continuous with a similar layer lining the outer surface of the body, and in the buccal cavity are a number of very small dark brown chitinous *denticles*, which are very regularly arranged. The posterior part of the pharynx (*dentary region*) has very thick walls composed of bundles of muscular fibres, which are concerned in the movements of a pair of laterally placed chitinous *jaws*. Each jaw is elongated in the direction of the long axis of the body, rounded at the posterior end or base where it is embedded in muscle, pointed at the apex, which is strongly incurved; the inner edge is divided into a number of strong serrations or teeth: the whole jaw might be compared to a pruning-hook with its cutting edge deeply serrated (Fig. 355, *B*).

Behind the pharynx the alimentary canal narrows considerably to form a tube, the *œsophagus* (*œs*), which runs through about five segments to open into the intestine.

Running backwards and inwards from the wall of the peristomium to the wall of the buccal cavity and pharynx are a number of bands or sheets of muscle, the *protractor muscles*, by the contraction

of which, and the pressure of the cœlomic fluid, this anterior part of the alimentary canal can be everted so as to form a *proboscis* (Fig. 355), and thus the jaws are thrust forth and rendered capable of being brought to bear on some small living animal or fragment of animal matter, to be seized and swallowed as food. The eversion is arrested at a certain point by means of a muscular diaphragm passing from the wall of the buccal cavity to that of the first body-segment. The proboscis is withdrawn again by a *retractor* sheet of muscle, which passes inwards and forwards to be inserted into the wall of the alimentary canal at the junction of the pharynx and œsophagus.

Into the œsophagus open a pair of large unbranched glandular pouches, or *cæca* (Fig. 356, *gl*), which probably are of the nature of digestive glands. The *intestine* (*int*) is a straight tube of nearly uniform character throughout, regularly constricted in each segment—the constrictions becoming much deeper towards the posterior

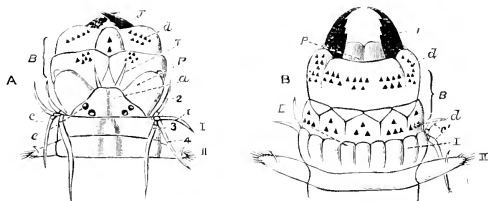

FIG. 355.—*Nereis diversicolor*, $\times 4$. Head with buccal region everted. **A**, dorsal view; **B**, ventral view. *a*, prostomium; *B*, everted buccal region; *c, c'*, peristomial tentacles, 1, 2, 3, 4; *d*, denticles; *e*, eyes; *E*, lower lip; *P*, palp in **A**, entrance to pharynx in **B**; *J*, jaw; *T*, prostomial tentacle; *I*, peristomium; *II*, parapodium of first body-segment. (From the *Cambridge Natural History*.)

end of the body. The part of the intestine which lies in the last segment is termed the *rectum*.

The wall of the alimentary canal (Fig. 357) consists (1) of the visceral layer of the cœlomic epithelium (*visc. peri*); (2) of a layer of longitudinal muscular fibres (*long. mus*); (3) of a layer of circular muscular fibres (*circ. mus*); and (4) of the enteric epithelium (*ent. ep*), consisting of close-set, long, narrow cells. To these layers is superadded in the buccal cavity and the pharynx an internal chitinous cuticle, continuous with that of the general outer surface.

Developmentally the buccal cavity and the pharynx constitute the *stomodæum*, the rectum the *proctodæum*, the rest of the alimentary canal the *mesenteron*.

The **wall of the body** consists of a cuticle, an epidermis or deric epithelium, muscular layers, and the parietal layer of the cœlomic epithelium (*par. peri*). The cuticle (*cut*) is a thin chitinous layer which exhibits an iridescent lustre due to the presence of two

intersecting systems of fine lines; it is perforated by numerous minute openings, the openings of the epidermal glands. The epidermis (*ep*) is very thin, except on the ventral surface, where it becomes considerably thickened. It consists of a layer of cells containing numerous twisted unicellular glands, which are most abundant on the ventral surface, particularly near the bases of the parapodia; on the dorsal surface the epidermis contains plexuses of fine blood-vessels. The muscular layers are two in number—an external, in which the fibres run circularly (*circ. mus*), and an internal, in which they run longitudinally. The latter is not a continuous layer, but consists of four bundles of fibres, two dorso-lateral (*dors. long. mus*) and two ventro-lateral (*vent. long. mus*).

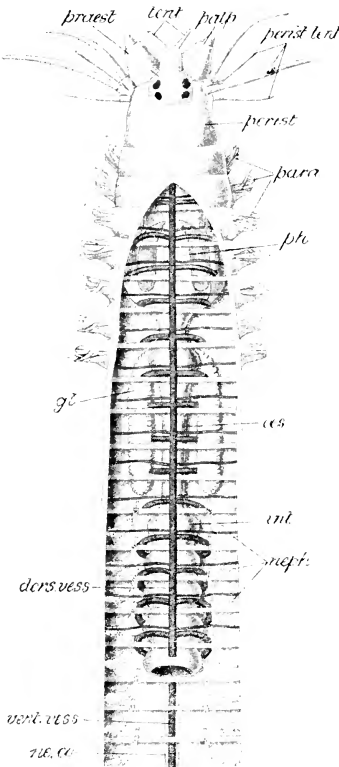

FIG. 356.—*Nereis dumerilii*. Semi-diagrammatic view of the anterior portion of the body with the dorsal body-wall removed, so as to show the alimentary canal, the septa, the blood-vessels, and the nephridia; a portion of the intestine removed so as to show the ventral blood-vessel and nerve-cord which lie below. *dors. vess.* dorsal vessel; *gl.* oesophageal glands; *int.* beginning of intestine; *ne. co.* nerve-cord; *neph.* nephridia; *oes.* oesophagus; *palp.* palp; *para.* parapodia; *perist.* peristome; *perist. tent.* peristomial tentacles; *ph.* pharynx with its jaws; *prost.* prostomium; *tent.* prostomial tentacles; *vent. vess.* ventral vessel.

undergoes contractions which are of a *peristaltic* character—waves of contraction passing along the wall of the vessel so as to cause the movement of the contained blood. These peristaltic contractions are more powerful in the

case of the dorsal vessel than in that of any of the others, and run with great regularity from behind forwards, so as to drive a current of blood in that direction. The contractions are brought about partly by a series of muscular fibres which are arranged in rings round the wall of the vessel at short intervals; but the wall of the vessel is itself contractile.

Along the middle of the ventral surface below the alimentary canal runs another large longitudinal vessel, the *ventral vessel* (*vent. vess.*), in which the current of blood takes a direction from before backwards. Connecting the dorsal and ventral vessels, there are in

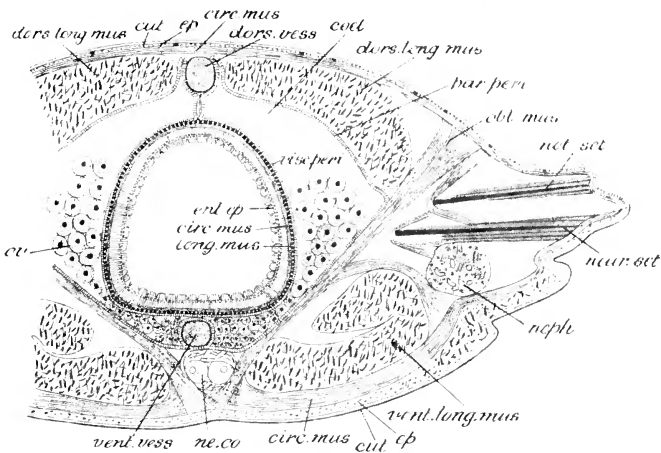

FIG. 357.—*Nereis dumerilii*. Semi-diagrammatic transverse section of the middle region of the body. *circ. mus.* (external), circular layer of muscle of body-wall; *circ. mus.* (internal) circular layer of muscle of wall of enteric canal; *coel.* coelome; *cut.* cuticle; *dors. long. mus.* dorsal longitudinal muscles of body-wall; *dors. vess.* dorsal vessel; *ent. ep.* enteric epithelium; *ep.* epidermis; *long. mus.* longitudinal muscle of wall of enteric canal; *ne. co.* nerve-cord; *neph.* nephridium; *neur. set.* neuropodial setæ and aciculum with their muscles; *not. set.* notopodial setæ and aciculum; *obl. mus.* oblique muscle; *ov.* ovary; *par. peri.* parietal layer of coelomic epithelium; *vent. long. mus.* ventral longitudinal muscle; *vent. vess.* ventral vessel; *visc. peri.* visceral layer of coelomic epithelium. (The entire extent of the coelomic epithelium is not represented.)

each segment two pairs of loop-like transverse vessels which give off branches to the parapodia, the alimentary canal, and neighbouring parts. Some of these branches communicate with plexuses of fine vessels in the interior of the lobes of the parapodia and in the integument of the dorsal surface, and with dilatations or sinuses situated in the bases of the parapodia. A delicate longitudinal neural vessel accompanies the nerve-cord.

Nereis is devoid of any *branchiæ*; but there can be little doubt that the lobes of the parapods with their rich blood-supply, and the

areas of integument occupied by plexuses of blood-vessels, subserve the function of respiration.

There is a well-developed **nervous system** (Fig. 358), which is bilateral and metameric in its arrangement, like the other systems of organs. Situated in the prostomium is a large bilobed mass of nerve-matter containing numerous nerve-cells, the *cerebral ganglion* or *brain* (*c*). This gives off *tentacular nerves* to the tentacles and palpi, and two pairs of short thick *optic nerves* to the eyes.

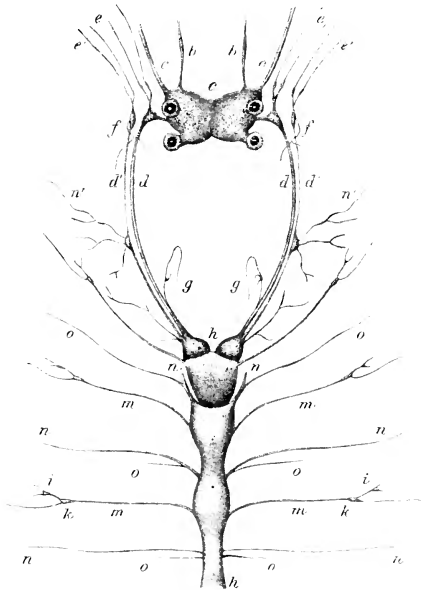

FIG. 358.—**Nereis**.—Anterior portion of nervous system, comprising the brain (*c*), the cesophageal connectives (*d*), and the anterior part of the ventral nerve-cord (*h*). (After Quatrefoiges.)

Behind, two thick nerve-strands, the *cesophageal connectives* (*d*), curve round the mouth in the peristomium to meet on the ventral aspect behind the mouth and below the pharynx. The cesophageal connectives with the cerebral ganglion thus form a ring around the anterior part of the enteric canal. From them are given off nerves to the two anterior pairs of peristomial tentacles. Running backwards from the point of union of the cesophageal connectives along the entire length of the body of the worm, on the ventral aspect, is a thick cord of nerve-matter, the *ventral nerve-cord* (*h*). In each segment this cord presents a little dilatation from which nerves are given off to the various parts of the segment; and each of these enlargements is really double, consisting of a pair of closely-united ganglia. The intermediate parts of the cord, between successive pairs of ganglia, are also double, consisting of a pair of longitudinal *connectives* enclosed in a common sheath. Given off behind from the cerebral ganglion is a system of fine nerves with occasional small ganglia, the *stomatogastric* or *visceral*

system, distributed to the anterior part of the alimentary canal. The first ganglion of the ventral cord, which is situated in the third segment, represents at least two double ganglia which have coalesced, as is shown by the fact that it gives off nerves to the two posterior pairs of peristomial tentacles and to the first pair of parapodia.

The tentacles and palpi, as well as the cirri, are probably organs of the sense of touch. The only other *sense-organs* are the four *eyes* and the two *nuchal organs*, all situated on the prostomium. The *eye* (Fig. 359) consists of a darkly pigmented cup, the *retina* (*re.*), with a small rounded aperture, the *pupil*, and enclosing a mass of gelatinous matter, the *lens* (*l.*). The wall of the cup is composed of numerous long and narrow cells lying parallel with one another in a radial direction. The outer end of each cell narrows into a nerve-fibre forming part of the optic nerve; near this end is a nucleus; the main body of the cell is densely pigmented; the inner part projects towards the lens as a clear hyaline rod (*r*). The cuticle of the general surface passes over the eye, and a continuation of the epidermis,

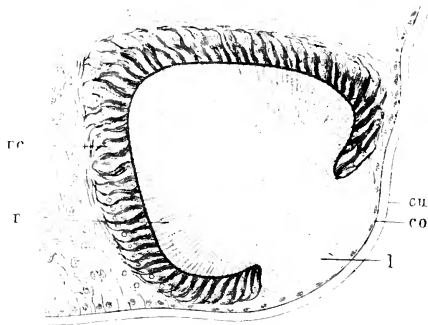

FIG. 359.—*Nereis*.—Section through one of the eyes. *co.* cornea; *cu.* cuticle; *l.* lens; *r.* layer of rods; *re.* retina. (After Andrews.)

with its cells somewhat flattened, constitutes the *cornea* (*co*). The *nuchal organs* consist of a pair of pits lined by a special ciliated epithelium with gland-cells, situated in close contact with the posterior part of the brain near the posterior part of the prostomium on the dorsal side. They are regarded as olfactory in function.

The organs which are supposed to perform the function of *excretion* are a series of metamericly arranged pairs of tubes, the *segmental organs* or *nephridia* (Figs. 356 and 357, *neph*, Fig. 360) occurring in all segments of the body with the exception of several at the anterior and posterior ends. The nephridium consists of two parts—a body and a narrow anterior prolongation. The body is of an irregular oval shape directed nearly transversely, but slanting somewhat; the outer end, situated in the base of the parapodium near its middle, is much the narrower;

the inner end is continuous with a narrow prolongation about equal in length to the body, which runs forwards and inwards to become attached to the mesentery. The external opening or *nephridiopore* (*ext. op*) is a fine circular pore capable of being widened or contracted, situated on the ventral surface not far from the base of the ventral cirrus. It leads into a canal, ciliated except in its most external part, which runs through the anterior prolongation to its extremity, where it bends sharply back again and runs to the body, through which it pursues an extremely tortuous course to the outer end, and then bends back again and runs in



FIG. 360.—*Nereis dumerilii*. One of the nephridia. *ext. op.*, external opening or nephridiopore; *fun.*, internal funnel or nephrostome [opening into the cœlome]; *mes.*, transverse mesentery or septum.

the anterior prolongation to the extremity of the latter, where it opens into the cœlome through a ciliated bell or funnel (*fun*), the *nephrostome*, projecting through the septum into the cavity of the segment next in front of that in which the body of the organ lies. The edge of the nephrostome is produced into a number of narrow ciliated processes not represented in the figure. Throughout its course the canal is excavated in a mass of nucleated material of a granular character not distinguishable into cells.

On the dorsal side of each segment, in close relation to the longitudinal muscular bundle, is a specially developed ciliated tract of the cœlomic epithelium of the nature of a short funnel without external aperture, the *dorsal ciliated organ*. It is possible that at the time of sexual maturity an aperture is formed through the body-wall opposite

this funnel, and that thus a genital duct of a temporary character becomes formed; but no such opening has ever been observed.

Nereis is unisexual. The **sexual elements**, ova or sperms, are formed from temporary masses of cells, *ovaries* or *testes*, which are developed towards the breeding season by a proliferation of the cells of the membrane (cœlomic epithelium) lining the cœlome and the structures it contains. In *Nereis dumerilii* there is in the male only a single pair of these proliferating masses of cells (*testes*), situated in one of the segments between the nineteenth and the

twenty-fifth. But in other species of *Nereis* they are much more numerous. These, during the season of their active development, give off groups of cells which become disseminated throughout the cœlomic fluid. The original cells (mother-cells) undergo division into smaller cells, each of which develops into a sperm with a minute rod-shaped *head* and a long vibratile flagellum or *tail*. In the female the *ovaries* (Fig. 357, *ov*), formed by a similar process of proliferation, take the form of rounded masses of cells, metamERICALLY arranged, surrounding the principal vessels throughout the length of the body. The young ova become detached from the ovaries, and attain their full development while floating about in the cœlomic fluid. Both ovaries and testes dwindle after they have given off the sexual cells, and at the non-breeding season of the year are not to be detected.

Ova and sperms, when fully ripe, are discharged, reaching the exterior probably through apertures temporarily formed by rupture of the body-wall (*cf.* above), and impregnation takes place by contact between the two sets of elements while floating freely in the sea-water.

Nereis dumerilii is an extremely *variable* species. If we compare a number of specimens, we find numerous **individual differences** between them. The most striking of these are differences of colour and of the number of segments in the body; but a careful examination reveals many other points in which individuals differ. Thus the precise form of the lobes of the parapodia, together with the number of setæ in the two bundles, varies; so also do the relative length of the tentacles, the number of teeth on the jaws, and the number and arrangement of the denticles in the buccal cavity. Not only are such individual differences common, but the species occurs in two distinct forms or *phases*, which differ from one another so widely that they have been referred to distinct genera. One of these is the *Nereis* phase, which is that described in the preceding paragraphs. A *Nereis dumerilii* may become sexually mature in this form, or may first undergo a series of changes by which it becomes converted into the second or *Heteronereis* phase (Fig. 352, *B*). The principal changes which take place during this metamorphosis are a great increase in the size of the eyes, and a marked modification of the parapodia in the posterior portion of the body, the lobes becoming larger and more leaf-like, and the setæ of the *Nereis* being superseded by others which are considerably longer, more numerous, and somewhat oar-shaped. The *Heteronereis*, instead of creeping about on the bottom, swims about actively through the water by wriggling movements of the body combined with active paddling movements of the parapodia with their long setæ. After a time the *Heteronereis*, like the *Nereis*, becomes sexually mature, developing ova and sperms, the latter of which differ remarkably in shape from those of the *Nereis* phase.

Development.—The egg of *Nereis* when first discharged is enclosed in a transparent thick gelatinous envelope, within which are two membranes—an outer, very thin and delicate, and an inner (*zona radiata*), thicker and very distinctly striated in a radial direction. The protoplasm of the ovum contains a number of oil-drops and yolk-spherules. When fertilisation takes place the yolk-spherules move away from what is destined to become the upper pole of the egg, leaving a polar area composed of granular protoplasm. The *zona radiata* disappears, and the contents of the ovum undergo for a time amoeboid changes of form. Then the spherical form is reassumed, two small bodies—the *polar bodies*—are thrown off at the upper pole, and the process of

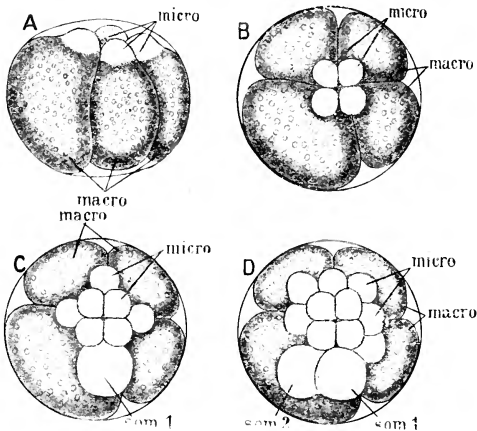

FIG. 361.—*Nereis*. Early stages in the development. *A*, lateral view of eight-celled stage; *B*, the same from above; *C*, stage of the formation of the first somatoblast; *D*, stage at which both somatoblasts are present; *macro*, megameres; *micro*, micromeres; *som. 1*, *som. 2*, first and second somatoblasts. (After Westinghausen.)

segmentation or cleavage begins (Fig. 361). This is of the spiral type, and up to a fairly advanced stage corresponds very closely with the segmentation of the Polyclad oosperm as described on page 268. The oosperm divides first into two parts, then into four. One of these (*A*, *B*) is larger than the rest. From these four cells—the *megameres*—there are separated off in succession three sets or quartettes of *micromeres*, making twelve in all. One of these, belonging to the second set, somewhat larger than the others and differing from them in its subsequent history, is termed the *first somatoblast* (*C*, *D*, *som. 1*); a *second somatoblast* (*som. 2*) is soon given off in the fourth quartette from the same megamere that gave origin to the first.

The germinal layers are now all established. The micromeres

constitute the *ectoderm*, destined to give rise to the epidermis and all its derivatives, to the cerebral ganglion and nerve-cord, to the oesophagus and rectum. The megameres eventually give origin to the cells of the *endoderm*, forming the internal epithelium of the alimentary canal. The second somatoblast gives rise to the entire *mesoderm* of the Annelid and contributes a few small cells to the endoderm of the intestine. As the micromeres multiply by division, they form at first a cap of small cells over the upper pole of the embryo; eventually the cap extends so as completely to cover the four megameres and the descendants of the somatoblasts except at one point, the *blastopore*, at the lower pole, where the investment remains for a time incomplete. When the blastopore closes, the process of epibolic gastrulation is completed. A thickening of the layer of ectoderm cells, the *apical plate*, in the middle of what is destined to form the head-end of the embryo, is the rudiment of the cerebral ganglion: in close relation to it are formed a pair of pigment-spots, the larval eyes. From the middle of the head-end projects a tuft of cilia (Fig. 362, *A*, *ap. cil.*). Encircling the body of the larva behind this is a thickened ridge, the *prototroch* (*prot*), the cells of which develop strong cilia. Just behind the prototroch the cells of the ectoderm become pushed inwards in the middle of what will eventually become the ventral surface, so as to line a sort of depression or pouch; this is the *stomodæum* (*st*) or rudiment of the mouth and oesophagus. The anus (*an*) does not appear until later; the position which it will subsequently occupy is indicated at this stage by a pigmented area (*pig. ar*) marking the point at which the blastopore becomes closed. The first and second somatoblasts divide to form a mass of small cells which extend on the ventral surface behind the prototroch and mouth, constituting what is termed the *ventral plate*; of this plate the more superficial cells are descendants of the first somatoblast; and those situated more deeply are derived from the second somatoblast. A superficial thickening of the ectoderm along the middle of the ventral plate is the rudiment of the ventral nerve-cord (*neur. pl*); the deeper cells divide and extend to form a pair of *mesoderm-bands* or *muscle-plates*, from which the muscles of the body-wall are developed; the muscular layers of the wall of the alimentary canal are derived from certain of the same set of cells which migrate inwards from the lower end.

A pair of micromeres separated from the rest at an early stage are destined to form the larval excretory organs, the *head-kidneys* or larval nephridia: at first situated at the upper end, they sink below the surface and migrate downwards till they come to lie below the prototroch; each then elongates, and a number of vacuoles which have become formed in the interior coalesce in such a way as to form a long, narrow canal. The embryo has now reached the completed trochophore stage.

The endoderm cells become arranged so as to bound a canal-

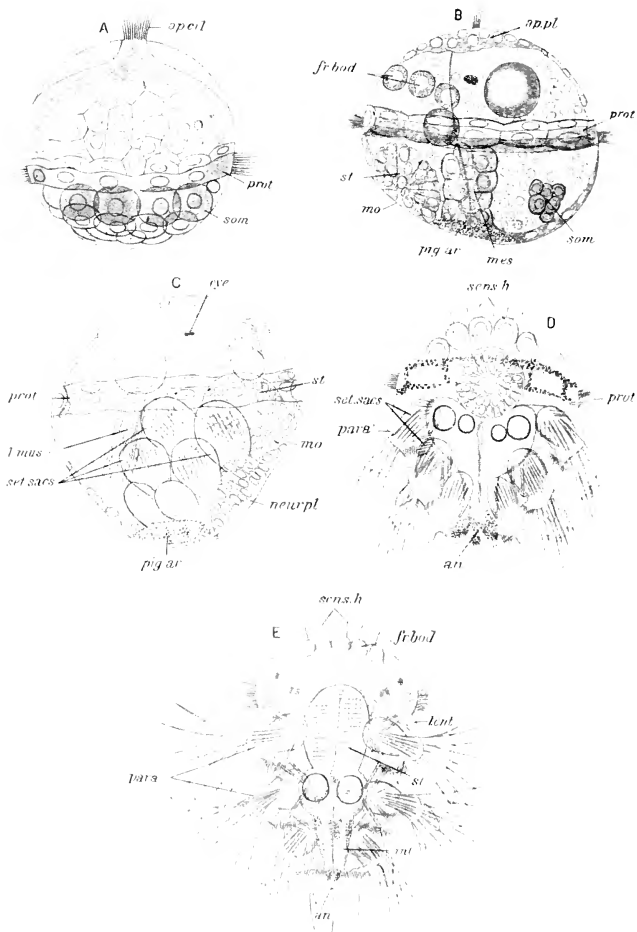

FIG. 362. **Nereis.** Later stages in the development. *A*, stage at which the prototroch and the apical tuft of cilia first become distinct. *B*, somewhat later stage, in which the stomodaeal invagination is being formed, and the rudiments of the mesoderm bands are distinct; *C*, late trochophore stage, in which there are rudiments of the setigerous sacs; *D*, somewhat later stage, in which the parapodia have begun to become prominent and the provisional setae project freely; *E*, larva with three segments. *an.* anus; *ap. cil.* apical cilia; *ap. pl.* apical plate; *eye*, eye; *fr. bod.* frontal bodies; *int.* intestine; *l. mus.* longitudinal muscle; *mes.* mesoderm; *mo.* mouth; *neur. pl.* neural plate; *para.* parapodia; *pig. ar.* pigmented area; *prot.* prototroch; *sens. h.* sensory hairs; *set. sacs.* setigerous sacs; *som.* second somatoblast and group of cells formed from it; *st.* stomodaeum; *tent.* peristomial tentacles. (After E. B. Wilson.)

like space, the beginning of the lumen of the middle part of the alimentary canal (œsophagus and intestine, *int*), the cells subsequently giving rise to the enteric epithelium. This canal becomes continuous in front with the stomodæum, and behind with a second smaller ectodermal invagination, the *proctodæum*, which arises in the position of the former pigment-area. The part of the larva behind the prototroch now elongates, and two pairs of invaginations, the *setigerous sacs* (*set. sacs*), appear at its sides: in the interior of these, to which a third pair is soon added, are developed setæ which grow out to a great relative length as the *larval* or *provisional setæ*. Constrictions soon appear marking off the first three segments, and at the same time the mesoderm bands undergo a corresponding division into three pairs of mesoderm segments. The mesoderm segments of each pair grow inwards towards one another and surround the alimentary canal: in the interior of each appears a cavity which is the beginning of a segment or chamber of the cœlome. As the two mesoderm segments become closely applied to one another and unite around the alimentary canal, their two cavities also come into close relation, and eventually are separated from one another only by thin vertical septa, forming dorsal and ventral mesenteries which subsequently disappear. Successive mesoderm segments also come into close relationship with one another, their cavities eventually only remaining separated by thin transverse partitions, which form the intersegmental septa.

The region in front of the prototroch becomes modified to form the prostomium of the adult. The part immediately behind forms the peristomium, which bears setæ, and is to be looked upon as the specially modified first segment. The body increases in length, and additional segments with their setigerous sacs become distinguishable (*E*), until, on the development of the tentacles, the outgrowth of the parapodia (*para*) with their cirri and the permanent setæ (which replace those first formed), the formation of the full number of segments, and the completion of the internal organs, the adult condition of the worm is attained.

b. THE EARTHWORM (*Lumbricus*).

General External Features.—The Earthworm (Fig. 363) has a long narrow body, which may be described as approximately cylindrical, but slightly depressed towards the posterior end. Dorsal and ventral surfaces are readily recognisable, the latter being much paler in colour than the former, and exhibiting a slight flattening; the anterior end is distinguishable in the living animal as that which is directed forwards in the ordinary creeping movements of the worm. The surface, as in the case of *Nereis*, is very distinctly marked out into segments or metameres by a

series of ring-like constrictions; the segments, which are very numerous, amounting to about 150, are somewhat longer towards the anterior end than they are further back.

At the extreme anterior end is a rounded lobe, the *prostomium*, immediately behind and below which is the opening of the mouth. Next to the prostomium is the most anterior segment, the *peristomium*, which bounds the mouth behind. The eyes and tentacles present in *Nereis* are not represented. On the most posterior

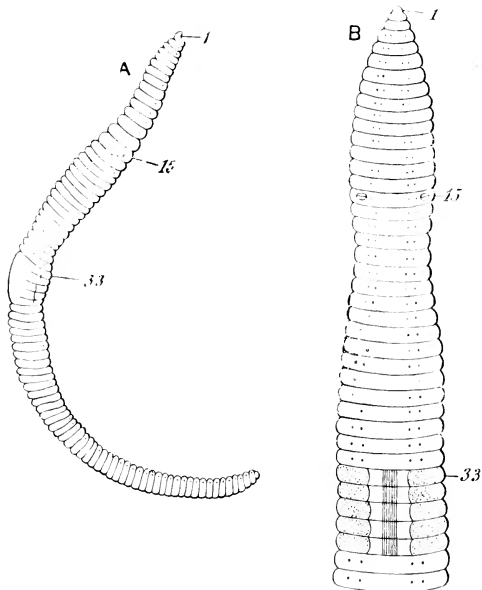

FIG. 363.—*Lumbricus*. A, entire specimen, lateral view; B, ventral view of anterior portion of the body, magnified. 1, prostomium; 15, 33, fifteenth and thirty-third segments. Each of the black dots represents a pair of setæ. (After Vogt and Jung.)

segment, the *anal segment*, is a small median opening, the *anal aperture*. A limited region of the body in front of the middle, comprising five or six segments, has a swollen appearance; this is termed the *clitellum*. There are no parapodia like those of *Nereis*, but running along the lower surface of the worm are to be recognised with the aid of a lens four double rows of short bristles or setæ (Fig. 364), a pair of each row occurring in each segment, which thus possesses eight altogether. The extremities of all these setæ are directed backwards, and they act as fulcra for the forward move-

ments of the worm on the surface of the ground or in the interior of its burrow. The setæ in the clitellum, and those in the neighbourhood of the genital apertures, are much slenderer than the rest. Along the middle line of the dorsal surface, from about the eleventh segment backwards, is a row of small apertures, one at the line of division between each contiguous pair of segments: these, which are termed the *dorsal pores*, perforate the body-wall and open internally into the cœlome. Through these cœlomic fluid is capable of being discharged, covering the surface with a thin layer which may protect the worm from desiccation or from contact with irritating substances. On the ventral surface are two rows of minute apertures—a pair on each segment—the *excretory apertures* or *nephridiopores*. On the ventral surface of the fifteenth segment (Fig. 363, 15) is a pair of slit like apertures with somewhat tumid lips, the *male reproductive apertures*; and on the segment immediately in front—the fourteenth—are two smaller rounded apertures, the *female reproductive apertures*. In the intervals between the ninth and tenth and tenth and eleventh segments are two pairs of small pores, the openings of the *receptacula seminis*.

The **body-wall** (Fig. 365) consists of a *cuticle*, an *epidermis* or *deric epithelium*, a *dermis*, *muscular layers* with associated connective tissue, and, lining the inner surface, a thin cellular membrane, the *peritoneum* or *cœlomic epithelium*. The *cuticle* (*cut.*) is similar to that of *Nereis*, and has a similar iridescent lustre; it is perforated by numerous minute apertures. The epidermis consists, except on the clitellum, of a single layer of cells elongated

in the vertical direction: many of these cells have the character of unicellular glands; many others are sensory cells, and are connected by fine nerve-fibres with the nerve-cord. On the clitellum the epidermis is thickened, and blood-vessels extend between the cells. Below the epidermis is a layer of connective tissue, the *dermis*. The muscular fibres which make up the greater part of the thickness of the body-wall are arranged in two principal sets—a layer of circularly arranged fibres (*circ. mus*) situated externally, immediately below the dermis, and a layer of longitudinally arranged fibres (*long. mus*) situated internally. The circular layer is interrupted at all the intervals between the segments; the longitudinal layer is interrupted along a series of longitudinal lines, so as to be divided into seven bundles.

The setæ (Fig. 364) are lodged in sacs, the *setigèrous sacs* (see Fig. 375), lined by a continuation of the epidermis. In the region of the body in which the reproductive organs are lodged some of



FIG. 364.—*Lumbricus*.
Setæ, highly magnified.

these sacs are enlarged and glandular, and receive the special name of *capsulogenous glands*.

The **enteric canal** (Fig. 366) is, as in *Nereis*, a tube which runs through the entire length of the body from the mouth at the anterior to the anus at the posterior end. As in the case of *Nereis*, it lies in a cavity, the *coelome*, lined by a thin cellular membrane, the *peritoneum* or *coelomic epithelium*, and filled with a fluid, the *coelomic fluid*, containing colourless corpuscles. The coelome is divided into a series of chambers corresponding to the segments

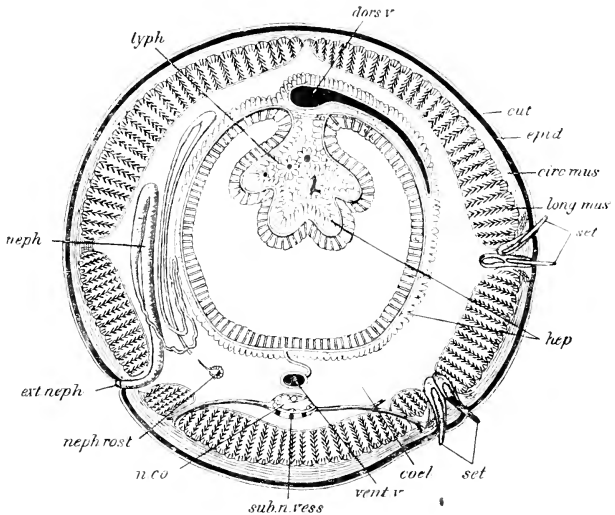

FIG. 365.—**Lumbricus**, transverse section of the middle region of the body. *circ. mus.* layer of circular muscular fibres; *coel.* coelome; *cut.* cuticle; *dors. v.* dorsal vessel; *epid.* epidermis; *ext. neph.* nephridiopore; *hep.* layer of chloragen cells; *long. mus.* longitudinal muscle; *neph.* nephridium; *neph. rost.* nephrostome; *n. co.* nerve-cord; *set.* setae; *sub. n. vess.* sub-neural vessel; *typh.* typhlosole; *vent. v.* ventral vessel. (After Marshall and Hurst.)

by a series of delicate transverse partitions, the *septa* or *mesenteries*, consisting of folds of the peritoneal membrane enclosing muscular fibres.

The mouth leads into a small *buccal cavity*. This is followed by a much larger, thick-walled, rounded chamber, the *pharynx* (*ph.*). From the wall of the pharynx there run outwards to the body-wall a number of radially arranged bundles of muscular fibres which, when they contract, draw the pharynx backwards, and at the same time dilate it. Behind the pharynx follows a comparatively narrow tube, the *oesophagus* (*oes*), which extends through about seven

segments. At the sides of the œsophagus, in each of the segments ten, eleven, and twelve, is a pair of rounded projections. The first pair—the *œsophageal pouches*—are hollow, and their cavities are in communication with the lumen of the œsophagus (*œs. gl.*). The other two pairs—the *calciferous glands*—are thickenings of the wall of the œsophagus, the fluid in the interior of which is milky, owing to its containing numerous particles of carbonate of lime; the numerous small cavities which they contain are in communication with the œsophageal pouches. Posteriorly the œsophagus is continuous with a rounded thin-walled chamber, the *crop* (*cr*), and this is followed by a very thick-walled chamber, also of rounded form, the *gizzard* (*giz*). From this the intestine (*int*) extends throughout the rest of the length of the body to the anal aperture. It is wide, with thick but soft walls, constricted opposite the septa, *i.e.* in the intervals between the segments. Running along the middle of its dorsal surface is a longitudinal fold, the *typhlosole* (Fig. 365, *typh*), projecting downwards into the lumen. On the wall of the intestine outside the muscular layers and surrounding the intestinal blood-vessels are a number of granular, yellow cells—the *chloragen cells* (*hep*): these are specially abundant in the typhlosole. The terminal part, situated in the last segment, is termed the *rectum*.

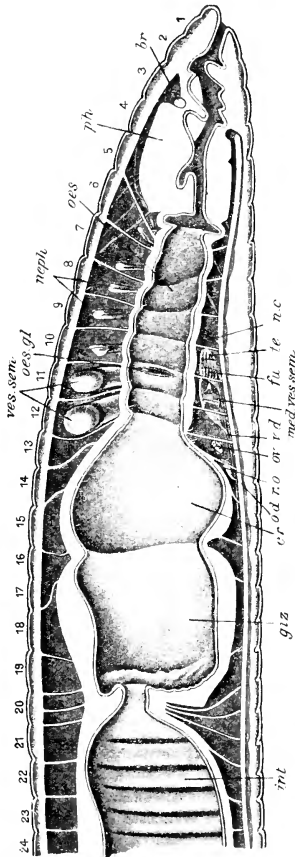

FIG. 366.—**Lumbricus.** Longitudinal section through the anterior half of the animal. *br*, brain; *ov*, ovary; *te*, testis; *int*, intestine; *med. ves. sem.*, middle seminal vesicle; *n.c.*, nerve cord; *neph.*, nephridia; *œs. gl.*, oviduct; *œs.*, œsophagus; *œs. gl.*, aperture of œsophageal pouch; *cr*, crop; *ph.*, pharynx; *r. o.*, receptaculum ovarium; *te*, anterior testis; *v. d.*, vas deferens; *ves. sem.*, posterior lateral vesiculae seminales. (After Marshall and Hurst.)

The whole alimentary canal is lined internally by a cuticle, which is thicker in the gizzard than elsewhere, and by a single layer of ciliated columnar epithelial cells, the *enteric epithelium*. Some of these cells, more granular than the others, grouped in certain regions—more particularly along the typhlosole—are of the nature of unicellular digestive glands, secreting a digestive fluid. Others seem to be specially concerned in the absorption of the digested food. External to this is a layer of connective tissue, between which and the external covering of yellow cells are muscular fibres, of which there are two layers, an external longitudinal and an internal circular. These layers are greatly thickened in the walls of the pharynx and of the gizzard.

The Earthworm, like *Nereis*, has a well-developed vascular system consisting of blood-vessels with well-defined walls. The blood is bright red, the colour being due to the same colouring matter, viz. *hæmoglobin*, as in the case of the blood of the higher animals, occurring, however, not in corpuscles, but in the liquid part or *plasma*; corpuscles are present, but they are colourless. The main trunks are the *dorsal*, the *ventral*, the *sub-neural*, the two *lateral neural*, and a series of *transverse branches*. The *dorsal vessel* (Fig. 365, *dors. v*) runs along the middle of the dorsal surface between the body-wall and the intestine; it is readily visible shining through the former in the living worm. The *ventral vessel* (*vent. v*) lies below the alimentary canal, the *sub-neural* below this

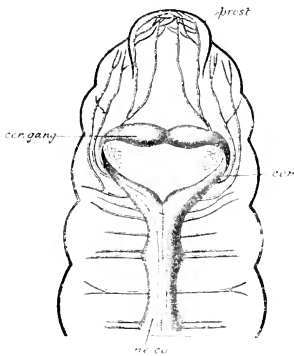

FIG. 367.—*Lumbricus*. Anterior portion of nervous system. *cer. gang.* cerebral ganglion or brain; *com.* oesophageal connectives; *ne.co.* ventral nerve-cord; *prost.* prostomium. (After Leuckart.)

again under the nerve-cord; the *lateral neural* lie on either side of the nerve-cord. The *transverse branches* correspond in number to the segments; they run round from the dorsal vessel to the ventral, giving off branches in their course. Five of them, viz. those in the seventh to the eleventh segments inclusively, are dilated and pulsate rhythmically; these have the function of driving the blood through the system of vessels, and are hence frequently termed the "hearts." The walls of the principal vessels are contractile, and assist in bringing about the movement of the blood, which is propelled in such a way as to run forwards in the dorsal vessel and backwards in the ventral, its direction of move-

ment being regulated by a number of valves in the "hearts," the dorsal vessel, and the chief vessels connected with it.

The **nervous system** (Fig. 367) consists of a dorsal bilobed *brain* or *cerebral ganglion* and a double *ventral nerve-cord* together with a pair of *oesophageal connectives*, by which the former is connected with the anterior end of the latter. The *brain*, which is of small size, is situated in the third segment, above the beginning of the alimentary canal; it is divided by a median constriction into two lateral parts of pyriform shape with their broad ends in contact. The connectives pass from this round the sides of the alimentary canal to unite in the middle below with the anterior end of the ventral nerve-cord. In this way a complete *nerve-ring* or *nerve-collar* surrounds the anterior part of the enteric canal in the third segment. From this the ventral nerve-cord extends backwards to the posterior end of the body, and in each segment it presents a slight enlargement or ganglion, as it is usually termed, most conspicuous in the more posterior segments. The whole cord is double, consisting of two intimately united right and left parts. From the brain, nerves are given off to the prostomium; and from the ventral cord three pairs of nerves arise in each segment. From the oesophageal connectives a series of *stomatogastric* nerves pass to the pharynx and neighbouring parts of the alimentary canal.

The Earthworm is devoid of organs of sight or hearing. It exhibits sensitiveness to bright light, the sensitive elements being large cells of the epidermis devoid of pigment. The sense of hearing appears to be absent; but a faculty analogous to taste or smell, enabling the animal to distinguish between different kinds of food, is well developed. The *goblet-shaped bodies*, groups of narrow epidermal cells, most abundant on the prostomium and peristomium, have probably to do with this faculty.

The **organs of excretion**—the *segmental organs* or *nephridia* (Fig. 368)—are similar to those of *Nereis*, but somewhat more complicated. They are slender tubes which occur in pairs in all the segments of the body except the first three and the last. Externally each nephridium opens by one of the small nephridiopores which have already been mentioned as occurring on the ventral surface; internally it ends in a funnel-shaped ciliated extremity with a crescentic slit-like aperture, the *nephrostome* (*nst*), opening into the cavity of the segment in front of that in which the external aperture occurs. The tube is thrown into three loops attached to the posterior surface of the corresponding septum by a fold of membrane. Two parts are clearly recognisable—an inner narrow and an outer wide part: in the former the narrow central lumen is a perforation through the axis of a string of cells, and is thus *intracellular*: it is lined in parts with cilia

arranged in two rows; in the latter (the *terminal vesicle*) the passage is lined by cells, and is thus *intercellular*, and there is a thick muscular investment. The nephridia are abundantly supplied with blood by means of nephridial branches of the ventral vessel.

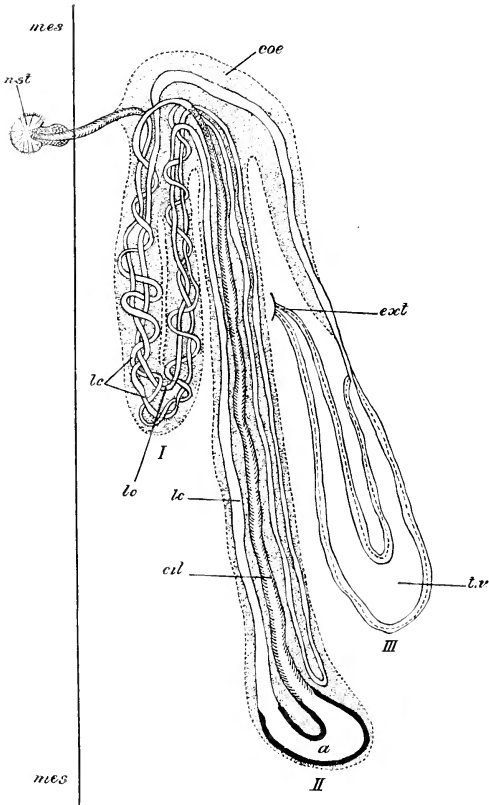

FIG. 368.—Nephridium of *Lumbricus* (diagrammatic).—*a*, ampulla between ciliated and non-ciliated parts of the intracellular canal; *cil*, ciliated part of the intracellular canal; *coe*, investment derived from the coelomic epithelium; *ext*, nephridiopore; *lc*, non-ciliated part of the intracellular canal; *mes*, septum; *n.st.*, nephro-stome; *t.v.*, intercellular canal of the terminal vesicle. *I*.—*III*, the three principal loops. (From Meis-enheimer, after Maziański.)

Reproductive Organs.—The Earthworm is hermaphrodite. There are two pairs of very small flattened *testes* (Figs. 366, 369, *te*,

te'), partly divided into a number of digitate lobes, situated in the tenth and eleventh segments. A pair of comparatively large sacs, the *anterior vesiculæ seminales* (*ant. ves. sem*), lie partly in the cavity of the ninth segment, but extend into the tenth, where they coalesce in the middle to form a large median sac of somewhat irregular form, the *anterior sperm-reservoir* (*ant. sp. res*). The anterior pair of testes project into this, and the cells destined to form the sperms, developed in the former, pass by dehiscence into the large median cavity. On either side is a large *ciliated funnel*, or *rosette* (*fun*), leading outwards from the interior of the

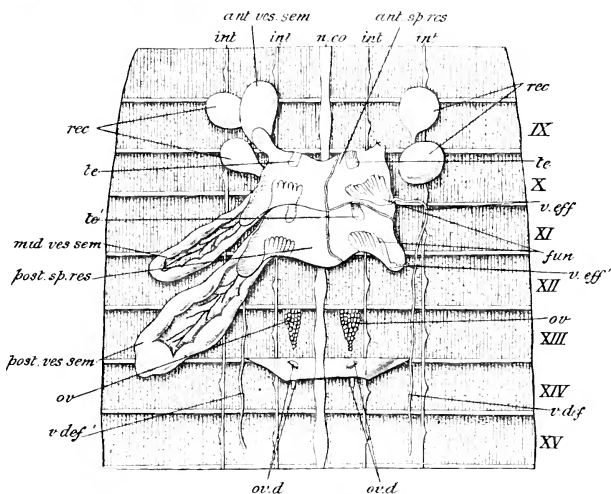

FIG. 360.—*Lumbricus*. Reproductive organs. *ant. sp. res.* anterior sperm reservoir; *ant. ves. sem.* anterior left vesicula seminalis; *fun.* funnel-like openings of vasa efferentia; *int.* intermuscular partitions; *mid. ves. sem.* middle vesicula seminalis; *n. co.* nerve-cord; *ov.* ovaries; *ov. d.* oviducts; *post. sp. res.* posterior sperm-reservoir; *post. ves. sem.* posterior vesicula seminalis; *rec.* receptacula seminis; *te.* anterior, and *te'*, posterior testes; *v. eff.* anterior, and *v. eff'*, posterior vas efferens; *v. def.* vasa deferentia. (After Vogt and Jung.)

reservoir. A second pair of vesiculæ seminales (*mid. ves. sem*), situated in the eleventh segment, also open into the anterior sperm-reservoir. A third pair (*post. ves. sem*), situated in the twelfth segment, unite in front to form the *posterior sperm-reservoir* (*post. sp. res*), which lies in the middle of the cavity of the eleventh segment. The posterior pair of testes have the same relation to this as the anterior pair have to the anterior reservoir; and a posterior pair of ciliated funnels (*fun*) lead outwards from its cavity. Each ciliated funnel passes into a narrow, somewhat convoluted duct, the *vas efferens*, and the two vasa efferentia of each

side unite to form a *vas deferens* or *spermiduct* (*v. def*), right or left as the case may be, which passes almost straight backwards to open by the corresponding male aperture on the fifteenth segment.

The female reproductive organs consist of a pair of *ovaries*, a pair of *oviducts* with a pair of *receptacula ovarum*, and two pairs of *receptacula seminis*. The *ovaries* (*ov*) are minute pear-shaped bodies, which are situated in the thirteenth segment, attached to the septum between the twelfth and thirteenth. The oviducts (*ov. d*) are a pair of short tubes, each with a comparatively wide funnel-shaped opening into the cavity of the thirteenth segment, and extending backwards and outwards in the fourteenth segment to open at the female aperture on the ventral surface of the latter. The *receptacula ovarum* are a pair of reniform sacs which open into the funnel-shaped ends of the oviducts. The *receptacula seminis* or *spermothecæ* (*rec*) are two pairs of rounded sacs which open on the exterior in the intervals between the ninth and tenth and tenth and eleventh segments.

Though hermaphrodite, the Earthworm is not self-impregnating, but two individuals provide for mutual fertilisation by an act of copulation. The copulating individuals apply themselves together by their ventral surfaces, the heads pointing in opposite directions, and become attached in this position by the setæ of the genital region and by a viscid secretion from the clitellum and of the capsulogenous glands (p. 446), situated in the neighbourhood of the reproductive organs. The sperms from the male apertures of each pass along temporarily formed grooves to the *receptacula seminis* of the other.

When the ova are mature they are discharged from the ovary into the cavity of the thirteenth segment, whence they pass out to the exterior through the oviducts, to be enclosed in the cocoon (*vide infra*), after having being detained for a time in the *receptacula ovarum*.

Development.—The oosperms or fertilised ova of the Earthworm are enclosed, together with a quantity of an albuminous fluid derived from the capsulogenous glands, in a *cocoon*, the wall of which is formed of a viscid secretion from the glands of the clitellum, hardened and toughened by exposure to the air. The cocoon is deposited in the earth and the embryos develop into complete, though minute, worms before they make their escape. The segmentation is somewhat unequal. A flattened *blastula* (Fig. 370, *A*) is formed, with a large but flattened segmentation-cavity. This becomes invaginated to form a cylindrical *gastrula* (*B*); the blastopore narrows and subsequently gives rise to the mouth of the adult. A pair of large *mesoderm* cells are early marked off from the other cells of the *gastrula*; these undergo division to form a pair of *mesoderm bands* (*C, mes*) composed of several rows of small cells which grow forwards towards the mouth.

By swallowing movements the embryo at this stage, having burst through the enclosing vitelline membrane, takes in the albuminous fluid in the interior of the cocoon, and increases rapidly in size. As the embryo elongates, the mesoderm bands become divided into segments, and the subsequent history of these is essentially similar to what has been already described in the case of *Nereis*. The ectoderm is thickened on each side along the line of the meso-

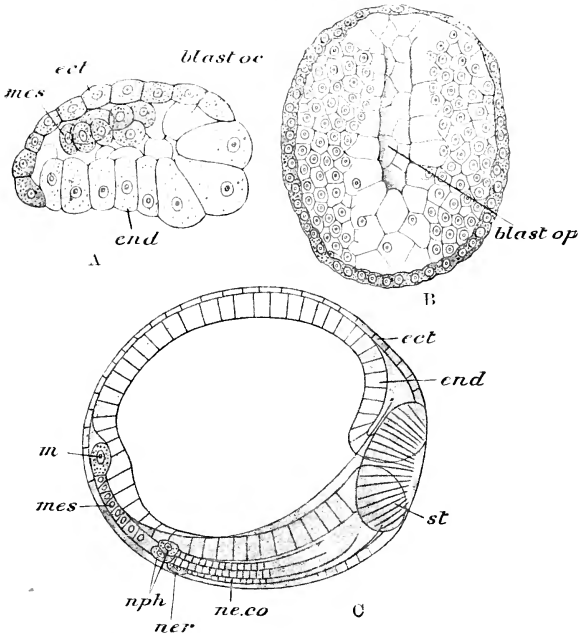

FIG. 370.—Early stages in the development of *Lumbricus*. *A*, lateral view of flattened blastula; *B*, ventral view of gastrula with slit-like blastopore; *C*, lateral view of later stage. *blastoc.* blastocoele; *blastop.* blastopore; *ect.* ectoderm; *end.* endoderm; *m.* primary mesoderm cell; *mes.* mesoderm bands; *ner.* cell from which the primitive nerve-cord (*ne. co.*) takes origin; *nph.* cells taking part in the formation of the nephridia; *st.* stomodaeum. (After Wilson.)

derm bands, and the mass of ectoderm cells so formed becomes arranged in a number of rows each originating behind in a larger rounded cell or *teloblast*. The innermost of these rows (Fig. 370, *C*, *ner*, *ne. co*) give rise to the ventral nerve-cord. The next two rows (*nph*) are said by some observers to give rise to the nephridia all but the funnels; but according to others the nephridia, or at least all their inner glandular portions, are of mesodermal derivation.

The brain and œsophageal connectives are formed in continuity with the rudiments of the ventral nerve-cord.

On the whole the development resembles that of *Nereis*, the chief differences being such as may be traced to the non-occurrence in the Earthworm of any free-swimming trochophore stage, with the absence of such larval structures as the large pre-oral lobe, the apical plate, the prototroch, and the larval nephridia or head-kidneys.

2. DISTINCTIVE CHARACTERS AND CLASSIFICATION.

The Chætopoda are Annulata with the body made up of distinct metameres, which are usually numerous and similar throughout. The metameres are provided with chitinous setæ developed in sacs (setigerous sacs) of the epidermis, and usually elevated on muscular appendages, the parapodia. There is a large cœlome divided internally into chambers by transverse septa, and not in communication with the blood-vascular system, which is nearly always highly developed. The ventral nerve-cord consists of a chain of ganglia. The reproductive cells are formed by a proliferation of certain parts of the peritoneum or membrane lining the cœlome, and usually reach the exterior through cœlomoducts or through modified or unmodified nephridia.

Sub-Class I.—POLYCHÆTA.

Chætopoda with the sexes distinct, and the ovaries and testes of simple character and metamERICALLY repeated. Highly developed parapodia are present, in most instances, bearing numerous long setæ. There is usually a definite head with eyes and tentacles, and often cirri and branchiæ on the segments of the body. A clitellum is never developed. A metamorphosis takes place: the larva is a trochophore. Nearly all the Polychæta are marine.

ORDER 1.—ARCHI-CHÆTOPODA.

Aberrant or primitive Polychæta¹ in which the nervous system is not separated from the epidermis, and the ventral cord is not segmented into ganglia. Only one genus (*Saccocirrus*).

ORDER 2.—PHANEROCEPHALA.

Polychæta with protrusible pharynx usually armed with chitinous jaws. There is a well-developed head. The segments are completely or nearly similar throughout the length of the body, and

¹ The *Archi-Chætopoda* are usually classed with the *Polychæta*, but their alliances are perhaps quite as close with the *Oligochæta*. In some respects *Saccocirrus* resembles *Polygordius* and *Protodrilus* (*Archi-Annelida*, *q.v.*), but is distinguished from them by the possession of setæ.

the parapodia are usually equally developed throughout and provided with cirri. The branchiæ, when present, are not confined to the anterior end.

ORDER 3.—CRYPTOCEPHALA.

Polychæta devoid of protrusible pharynx and of jaws or teeth. The head is frequently very small, and sometimes is devoid of eyes or of tentacles, the prostomium sometimes much reduced and covered over by the peristomium. The body is distinguishable, by differences in the form of the segments, parapodia, and setæ, into two or even three regions. The parapodia are little prominent in the posterior parts, and usually without cirri. The branchiæ, when present, are usually confined to the anterior end, and are sometimes represented by modified cephalic palpi.

Sub-Class II.—OLIGOCHÆTA.

Chætopoda with the sexes united, the reproductive system complicated, the ovaries and testes compact and never more than two pairs of each. No definite parapodia are developed and no cirri, and only a small number of simple setæ on each segment. The head is not distinct. A clitellum is usually present. There is no metamorphosis. Mostly terrestrial or fresh-water forms.

ORDER 1.—MICRODRILI.

Small Oligochæta with relatively few segments, often multiplying asexually. The male genital pores are on, or in front of, the seventh segment. The vasa deferentia are short, opening on the segment immediately behind that in which the internal apertures are situated. The anterior part of the body is often distinguished from the rest by a difference in the form and arrangement of the setæ. The clitellum, which is composed of only one layer of cells, is situated comparatively far forward. Eye-spots are frequently present.

ORDER 2.—MEGADRILI.

Mostly large Oligochæta with many segments, never multiplying asexually. The male genital pores are behind the seventh segment. The vasa deferentia are elongated, passing through two or more segments. The anterior part of the body is never specialised as regards its setæ. The clitellum, which consists of two layers of cells, never begins in front of the twelfth segment. Eye-spots are not developed.

Systematic Position of the Examples.

Nereis dumerilii is one of many species of *Nereis* differing from one another in certain minor details of their structure—such as the relative length of the palpi and tentacles, the size and form of

the eyes, the shape of the parapodia, the form of the setæ, and the like. The genus *Nereis* differs from the other genera of the family *Nereidæ*, to which it belongs, in having the parapodia biramous and the cirri simple, and in the presence of a series of denticles in the buccal cavity in addition to the pair of jaws. The family *Nereidæ* differs from all the other families of the sub-order *Nereidiformia* of the *Phanerocephala* in the union of the following characters:—The body is always elongated and made up of a considerable number of segments. The prostomium is well developed, and bears a pair of tentacles, a pair of palpi, and four eyes. The peristomium is devoid of parapodia, and has four pairs of tentacles. The parapodia are either uniramous or biramous; both dorsal and ventral cirri are present; the setæ are compound (articulated). There is a pair of anal cirri. In the pharynx there is always a pair of horny jaws, and usually a number of denticles in the buccal cavity.

The members of the sub-order *Nereidiformia* are all characterised by the possession of well-developed tentacles and palpi, and usually peristomial cirri. There are highly developed parapodia with acicula, jointed setæ, and dorsal and ventral cirri. The buccal region of the enteric canal is eversible as a proboscis, and there are usually horny jaws.

There are several species of the genus *Lumbricus*, differing from one another in the general form of the body, the number of the segments, the shape of the prostomial lobe, and other minor points. All of them agree in the presence of the following features, which characterise the genus and distinguish it from the many other genera of the family *Lumbricidæ*:—

The prostomium is dovetailed completely into the peristomium. The setæ are always in couples. There are longer and straighter setæ on the clitellum. The male apertures are always on the fifteenth segment. There are three pairs of vesiculæ seminales, in the ninth, eleventh, and twelfth segments, connected across the middle line in the tenth and eleventh by sacs enclosing the ciliated funnels. There are two pairs of receptacula seminis always situated in the ninth and tenth segments.

The family *Lumbricidæ* is distinguished from the other families of the sub-order *Megadrili*, which comprises all the Earthworms, by the combination of the following features:—

The clitellum usually begins behind the twentieth segment and occupies from six to nine segments; it is incomplete ventrally. Dorsal pores are present. The setæ on the clitellum differ from the others. The male apertures are not situated further back than the fifteenth segment. There are three or four pairs of vesiculæ seminales, in the ninth to the twelfth segments. The testes and ciliated funnels are usually in the tenth and eleventh segments: the female apertures on the fourteenth.

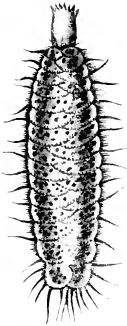

FIG. 371.—**Polynoe setosissima.** Dorsal view of entire animal, with the pharynx protruded. (After Quatrefages.)

These segments are usually very similar throughout the length of the body; but in the *Cryptocephala* (Figs. 372, 373, 379) there may be two or even more regions distinguishable from one another by the form of the segments and of their appendages. In the *Oligochaeta* there is a thickened zone, the *clitellum*, comprising sometimes only one segment, sometimes a number. Each segment, with certain exceptions to be noted presently, bears either a pair

3. GENERAL ORGANISATION.

The general form of the body in the *Chaetopoda* is cylindrical, but in many, *e.g.*, some members of the families *Polynoidae* (Fig. 371) and *Amphinomidae*, there is a very considerable degree of dorso-ventral compression. In most the body is very long in comparison with its breadth; but this is not a universal rule, the length being in some cases not more than five or six times the breadth. The surface is marked out by a number of more or less distinct annular constrictions or impressed lines into a corresponding series of *segments* or *metameres*, which are usually very numerous, often some hundreds in number, though in some cases there are not more than from twenty to

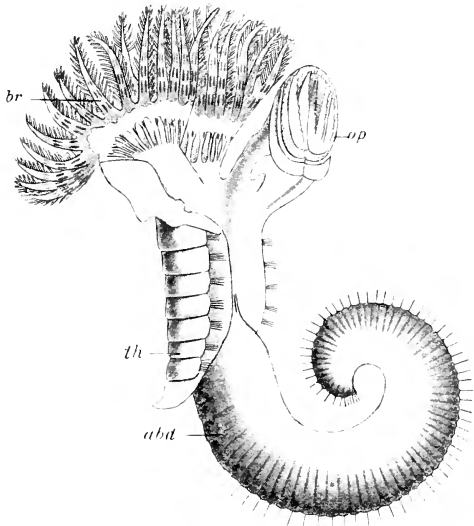

FIG. 372.—A **Serpulid** (*Galeolaria cuspidata*). Lateral view of animal removed from its tube. *abd.* abdomen; *br.* branchiae; *op.* operculum; *th.* thorax.

of *parapodia* or merely a greater or smaller number of setæ. Parapodia are lateral hollow processes of the body-wall bearing a number of bristles or setæ. Frequently the parapodium is divided horizon-

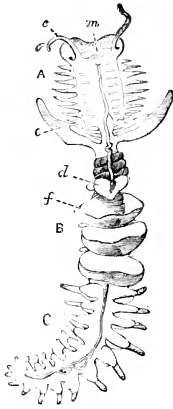

FIG. 373.—*Chaetopterus*. Natural size of a young specimen. *A*, anterior region of the body; *B*, middle region; *C*, hinder region. *c*, peristomial cirri; *d*, "sucker"; *e*, the great "wings"; *f*, the first of the three "fans"; *m*, mouth. (From Benham, after Pauceri.)

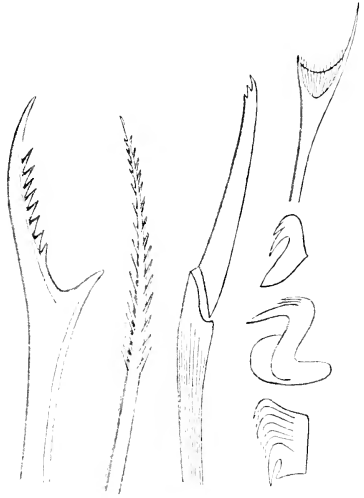

FIG. 374.—Setæ of various Polycheta. (From Claparède.)

tally into two distinct lobes or branches—a dorsal which is termed the *notopodium*, and a ventral which is termed the *neuropodium*.

Even when this is not the case there may be two bundles of setæ representing the two parts. The setæ are nearly always chitinous; in *Euphrosyne* they are calcified. They are always solid, except in *Euphrosyne*, entire, or divided into a number of joints. In shape (Fig. 374) they vary greatly in different groups; often several very distinct forms of setæ are present in different parts of each parapodium of a single worm, or in parapodia of

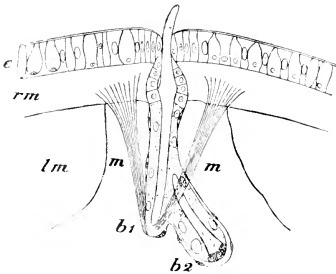

FIG. 375. Section of the setigerous sac of an Oligochaete. *b*₁, setigerous sac; *b*₂, supplementary follicle with seta; *c*, dermic epithelium (epidermis); *lm*, longitudinal muscles of body-wall; *m*, muscles of the setigerous sac; *rm*, circular muscular layer of body-wall. (From Hatschek, after Vejdovsky.)

different regions of the body. Some are exceedingly delicate and hair-like, others needle-shaped, others compressed and sabre-like, others bayonet-like. Very often there is a long, straight, narrow part or handle with which is articulated a terminal blade, or bayonet, or hook. Sometimes the setæ are quite short, projecting little beyond the parapodia, and are hook-like or comb-like. Usually each bundle contains, in addition to the ordinary setæ, a stouter, straight, simple seta, which scarcely projects on the surface; this is termed the *aciculum*. Each seta, or each bundle of setæ, is lodged in a sac, the *setigerous sac* (Fig. 375), formed by an

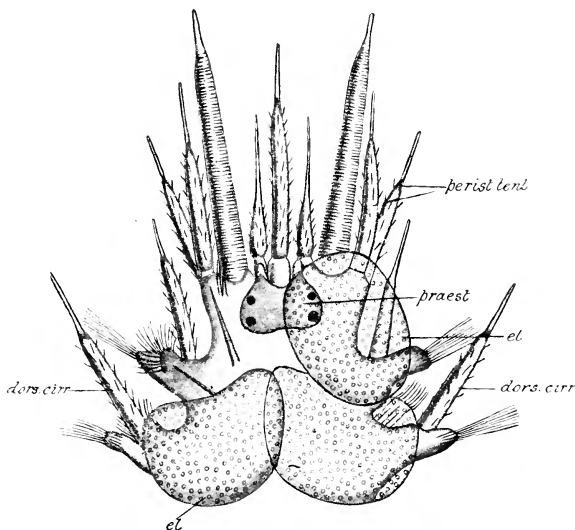

FIG. 376.—*Polynoe extenuata*. Dorsal view of anterior extremity. *dors. cirr.*, dorsal cirri; *el.*, elytra; *perist. tent.*, peristomial tentacles; *praest.*, prostomium. (After Claparède.)

invagination of the integument, and lined by cells continuous with the epidermis. Each seta is derived from one of these cells, and is to be looked upon as a specially developed part of the cuticle of the general outer surface. The setigerous sacs are usually provided with protractor and retractor muscles, by the action of which the setæ may be thrust out or retracted.

In addition to the setæ the parapodium bears very commonly certain soft appendages of a sensory character, the *cirri* (Fig. 353, *dors. cirr.*, *vent. cirr.*). There are usually both dorsal and ventral cirri, the latter nearly always much smaller than the former. The

cirri are usually filamentous, sometimes jointed; sometimes they are laterally compressed and leaf-like. In *Polynoe* (Figs. 371 and 376) and its allies certain of the parapodia bear, instead of dorsal cirri, flattened scales, the *elytra* (*el.*), richly supplied with nerves: these are sometimes looked upon as modified dorsal cirri, but in some members of the group cirri and elytra occur together on the same segment.

In *Sternaspis* a ventral shield formed by a thickening of the

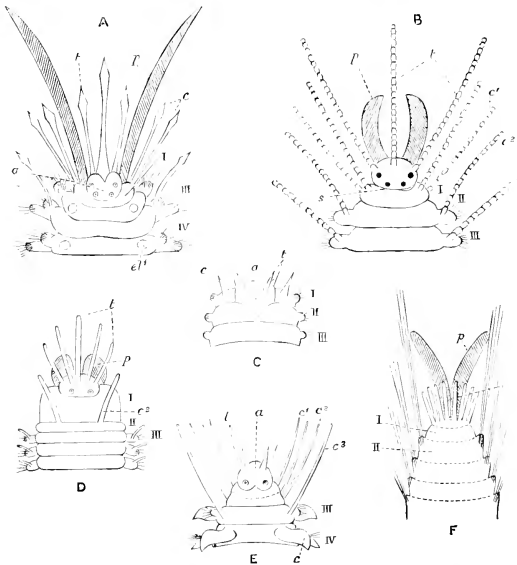

FIG. 377.—Heads of various **Polychæta** (diagrammatic). A, *Polynoid*; B, *Syllid*; C, *Nephthys*; D, *Eunice*; E, *Phyllodoce*; F, *Trophonia*. a, prostomium; c, cirri of body-segments; c¹, peristomial cirri (tentacles); c², cirrus of first body-segment; c³, cirrus of second body-segment; el', point of attachment of elytron; p, palp; s, nuchal organ; t, tentacle; I, peristomium; II, III, IV, segments. (From the *Cambridge Natural History*.)

cuticle in the posterior region of the body bears a number of setæ round its edge.

In the *Oligochæta* (Fig. 378) the parapodia are absent as processes of the body-wall, and are merely represented by a small number of short setæ each lodged in its sac; cirri are not developed. In certain *Oligochæta* setæ are absent.

The first segment or *prostomium*, together with the second or *peristomium*, forms in many *Polychæta* a very distinct head; the prostomium in such a case bears eyes and tentacles and contains the cerebral ganglion; on the peristomium is the opening of the

mouth, and from it also arise the *peristomial tentacles*. A ventral pair of prostomial tentacles, somewhat thicker than the rest, are sometimes to be distinguished, and are termed the *palpi*. Neither prostomium nor peristomium bears parapodia, though an aciculum is sometimes developed in the latter; the prostomium, in fact, is not quite correctly termed a segment, being different from the true segments both in structure and in mode of development. In the Oligochaeta there is no definite head, tentacles are entirely absent, and in the terrestrial forms the prostomium does not lodge the cerebral ganglion. In *Sternaspis spinosa* the prostomium is elongated and bifurcated like the proboscis of the *Echiurida* (*vide infra*).

The last segment is termed the *anal segment*, owing to its bearing the anal opening; it usually also differs from the preceding segments in wanting the parapodia and in having a pair of special cirri, the *anal cirri*.

Branchiæ are borne on the dorsal surfaces of more or fewer of the segments in many of the Polychæta. Sometimes they occur on all, or nearly all, the segments; sometimes they are confined to the middle region of the body; sometimes they are present only at the anterior end, as in the majority of the Polychæta living habitually in tubes (Figs. 372 and 379). In the *Terebellida* (Fig. 379) the branchiæ are situated on the dorsal surfaces of some of the anterior segments. In the *Serpulidæ* (Fig. 372) they form two incomplete lateral circles of elongated appendages



FIG. 378.—**Tubifex** (*Microdril*). General view of the animal. (After D'Udekem.)

situated at the anterior end of the body, apparently representing 'modified palpi, and sometimes supported by a cartilaginous skeleton; one of them is enlarged to form a stopper or *operculum* (*op.*), often armed with calcareous plates and spines, for the closure of the mouth of the tube in which the annelid lives. In shape the branchiæ are sometimes filiform, sometimes compressed and leaf-like, sometimes branched in a tree-like manner, some-



FIG. 379. — **Terebella.** (After Quatrefages.)

times pinnate. In *Serpula* (Figs. 372 and 390) and its allies each branchia consists of an elongated stem on which are borne two rows of short filaments. The surface of the branchiæ is usually ciliated. They are richly supplied with blood-vessels when a blood-vascular system is developed; in *Glycera*, in which there are no blood-vessels, each branchia contains a diverticulum of the coelome.

In the Oligochaeta branchiæ are rarely present; but in certain

of the Microdrili there are metamericly arranged simple or branched branchiæ, sometimes retractile, on the segments of the posterior region.

The **body-wall** consists of a cuticle, an epidermis, muscular layers, and a layer of peritoneum. The *cuticle*, composed of a chitinoid material, usually presents two systems of fine lines intersecting one another at right angles: it is perforated in many places by the ducts of the unicellular glands of the epidermis. The epidermis consists of a single row of cells, in some cases with smaller cells of replacement intercalated between their inner ends. In shape the cells vary greatly in different families and often in different parts of the body of the same worm, being sometimes flattened, sometimes cubical or polyhedral, but more usually more or less vertically elongated. Cilia occur on the surface in certain parts in many Chætopoda. Among the ordinary cells of the epidermis there are usually numerous unicellular glands often containing rod-like bodies. In the tubicolous forms these unicellular glands are active in secreting the material for the construction of the tube. In addition, the epidermis frequently contains sensory cells, which are in many cases contained in certain special elevations or sensory papillæ.

The *muscular* part of the body-wall consists of two layers, in the outer of which the fibres are disposed circularly, while in the inner their arrangement is longitudinal. The circular layer is continuous, or, more usually, is interrupted opposite the intervals between the segments. The longitudinal layer is disposed in four bands in the Polychæta, two dorso-lateral and two ventro-lateral. In the Oligochæta it is divided by the setigerous sacs which pass through it.

The *peritoneal* or *cœlomic epithelium* consists of a single layer of cells. These are usually non-ciliated, but are ciliated in the *Aphroditea*, *Glycera*, and some others, the movement of the cilia bringing about an active circulation of the *cœlomic* or *perivisceral fluid* in the cœlome.

The **body-cavity** or **cœlome**, a wide space intervening between the wall of the body on the one hand and that of the enteric canal on the other, is divided in many Chætopoda by a series of transverse septa into a series of chambers corresponding to the segments. The septa are not complete partitions, there being always apertures of greater or less extent by which the cavities of neighbouring segments communicate. The septa consist of double folds of the peritoneum enclosing muscular fibres.

The **enteric canal** is an elongated and nearly always straight tube, running through the entire length of the body from mouth to anus. A number of different parts are usually distinguishable; but their disposition varies to a very great extent in the different groups. The buccal cavity, into which the mouth leads, is followed by a muscular pharynx; these are both formed in the embryo by

invagination of the ectoderm, and therefore correspond to a *stomodæum*. The muscular pharynx is absent in some of the *Cryptocéphala*: when present it is frequently protrusible to a greater or less extent (see Figs. 355, 371); around its extremity, when it is fully protruded, are to be seen a circlet of papillæ in some forms; and in many, one or more horny teeth, situated in its interior, are brought into play. A *gizzard* with thick walls may follow upon this protrusible pharynx, and is sometimes preceded by an *œsophagus*, which may be dilated behind into a *crop*. The *intestine* is nearly always more or less deeply constricted inter-segmentally, and in the *Aphroditeæ*, or "Sea-mice" (Fig. 380), there are in each of the segments (with the exception of one or two of the most anterior



FIG. 380.—Enteric canal of *Aphrodite*. *a*, mouth; *b*, pharynx; *c*, branching caeca of intestine; *d*, anus. (From Gegenbaur's *Comparative Anatomy*.)

and one or two of the most posterior) a pair of *cæca* which are to a greater or less extent branched at their extremities. In the *Hesionida* a pair of *cæca* which open into the anterior part of the intestine frequently contain gas, and probably have a hydrostatic function. In some of the terrestrial *Oligochaeta* (Earthworms) a fold of the intestinal wall, the *typhlosole*, projects into its lumen. The intestine is straight in most, but is somewhat coiled in the *Chloramidæ*, *Sternaspis*, and others. The wall of the alimentary canal consists (1) of the visceral layer of peritoneum; (2) of longitudinally arranged muscular fibres; (3) of circularly arranged muscular fibres; (4) of enteric epithelium. The peritoneum on the surface of the intestine has in many *Chætopoda* its cells enlarged and granular to form the so-called *chloragen cells*, which probably have an excretory function. The enteric epithelium is very generally ciliated; it contains numerous gland-cells. The *stomodæum* and the *proctodæum* are lined internally by a cuticular layer, which is continuous with the cuticle of the general surface. The anus is usually terminal in position, sometimes directed towards the dorsal aspect. There is, in most instances, a longitudinal mesentery running to the alimentary canal from the dorsal body-wall; sometimes a ventral mesentery is also present bearing a corresponding relation to the ventral surface.

Some *Chætopoda* are entirely devoid of **blood-vessels**. In one family in which this is the case (the *Glyceridæ* among the *Phanerocephala*), the perivisceral fluid, which assumes some of the functions of the blood, contains numerous red corpuscles, the red colour of which is due to the presence of hæmoglobin (see p. 36). In the majority of the *Chætopoda* there is a highly developed vascular

system. Sometimes the blood is colourless: very commonly it is bright red in colour, owing to the presence of hæmoglobin, which is not confined to the corpuscles, but is dissolved in the plasma. In *Serpula* and its allies the blood is bright green, owing to the presence of a green colouring matter, which has an affinity for oxygen similar to that possessed by hæmoglobin.

The chief blood-vessels are usually dorsal and ventral longitudinal trunks. These are connected together by metamericly arranged transverse branches. In some of the *Cryptocephala* the dorsal vessel is not present in the greater part of the length of the body, its place being taken by a peri-intestinal sinus or a plexus of vessels lying in the wall of the alimentary canal. This gives off in front a short thick-walled dorsal vessel or "heart." The movement of the blood is effected in most instances by peristaltic contractions of the dorsal vessel, or of a peri-intestinal sinus or plexus, or of the "heart" given off by the latter anteriorly, which have the effect of driving the blood from behind forwards. In some instances, as in the Earthworms and some *Cryptocephala*, specially dilated lateral vessels are contractile, and by their pulsations bring about the circulation of the blood through the system of vessels. Plexuses of fine capillary vessels in the integument of various parts frequently aid in respiration, and are particularly well developed in certain forms in which definite organs of respiration are absent.

The **nervous system** consists of a cerebral ganglion or *brain* and a double *ventral chain* of ganglia. The cerebral ganglion is distinctly bilobed, and may be looked upon as composed of two intimately united ganglia. It is almost invariably situated in the prostomium, though placed a little further back in the Earthworms; it gives off branches to the eyes and tentacles. From it there run backwards and downwards the paired *œsophageal connectives*, which embrace the anterior part of the alimentary canal between them, and below join the anterior end of the ventral chain of ganglia. The latter always exhibits indications of being made up of two lateral halves in the double character of the connecting commissures and frequently of the ganglia themselves. One of these double ganglia occurs in each segment, and from it a number of nerves pass out to the various parts of the segment. In certain *Cryptocephala* (*Serpula* and others) the two halves of the chain are separated from one another by a wide space, across which transverse commissures pass between the ganglia. Connected with the cerebral ganglia, or with the *œsophageal connectives*, or with both, there is a system of delicate *stomatogastric nerves* passing to the walls of the anterior part of the alimentary canal. In the majority of the *Chaetopoda* the cerebral ganglion and the ventral chain are separated from the epidermis; in some, however, the ventral chain is in contact with the epidermis, and in certain primitive or aberrant forms, the *Archi-Chaetopoda* (Fig. 381) and *Sternaspis*, the cerebral

ganglion is in close union with the epidermis; in these also the ventral cord is not segmented into ganglia. Running longitudinally through the ventral cord in many forms are certain *giant fibres* of very large size; though these may have rather a skeletal than a nervous function, they are simply greatly enlarged and modified nerve-fibres. Nerve-cells may be confined to the ganglia, or may be distributed over the entire surface of the ventral cord. *Giant nerve-cells* occur in some forms in certain regions. Small ganglia are found frequently in various peripheral parts, more especially at the bases of cirri or of sensory papillæ.

The organs of special sense are *eyes*, *tentacles* and *cirri*, *nuchal organs*, and *otocysts*. *Eyes*, absent in the Oligochaeta with

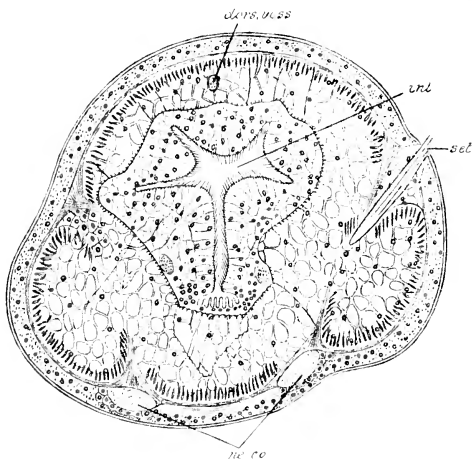

FIG. 381.—*Saccocirrus*, transverse section, to show the position of the nerve-cords. *dors. vess.* dorsal vessel; *int.* intestine; *ne. co.* nerve-cord; *set.* setæ. (After Fraipont.)

a few exceptions and in some of the tube-forming Polychæta as well as in a few free forms of that sub-class, are very general in their occurrence. Their structure is, as a rule, very simple, but in some forms reaches quite a high grade of development. Usually they are confined to the prostomium, but *Polyophthalmus*, in addition to the prostomial eyes, has pairs of eye-like organs—probably light-producing (phosphorescent) organs—on many of the segments of the body. *Leptochoe* has a pair on each segment, and in *Fabricia* there is a pair on the anal segment; while in many species of *Sabella* and all the species of *Dasychoe* there are eyes on the branchial filaments.

Most usually the eye is (as in *Nereis*, p. 437, Fig. 359) a

spherical capsule with a wall composed of a single layer of cells, which are elongated on the inner side, *i.e.* the side turned towards the brain, while on the outer side they are usually flattened. The outer thin part of the wall of the capsule, or *cornea*, is sometimes united with the epidermis; when the two layers remain distinct, the outer one is the *outer cornea*, the inner the *inner cornea*. In many cases a thickening of the surface cuticle over the cornea forms a *cuticular lens*. The cells of the inner portion of the wall of the capsule form the elements of the *retina*; they are long narrow cells, sometimes composed of three distinct segments—(1) a clear *rod*, directed towards the central cavity; (2) a middle segment which is densely pigmented; and (3) a segment containing the nucleus of the cell and directed towards the brain or the optic ganglion, with which it is connected by a nerve-fibre. Frequently the second and third segments are not to be separately recognised, the whole of that part of the cell which contains the nucleus being densely pigmented. A refractive mass fills the interior of the capsule, and is sometimes distinguishable into a firmer outer part, the *lens*, and a more fluid inner part, the *vitreous body*. This refractive mass is often continuous with the cuticle externally, and internally may be in continuity with the rods. In some cases the structure of the eye is very much simpler. The eyes on the branchial filaments of many tube-forming Polychæta consist each of a group of retinal cells having its own lens-like body and quite independent of the others; the eye is thus a *compound* one.

Nuchal organs or *ciliated pits* (Fig. 377, *B, s*) are very general in the Polychæta. They consist of a pair of special ciliated areas or pits on the head, eversible in certain cases.

Otocysts (*statocysts*) are only exceptionally present. They consist of capsules of ciliated cells, in the fluid contained in which there are one or several calcareous otoliths (*statoliths*).

Tactile cells of the epidermis, with or without a projecting tactile hair or stiff cilium, are very common, especially on the prostomium in the Oligochæta and on the tentacles and cirri in the Polychæta. Groups of these are often aggregated together in *papillæ* or *goblet-bodies*, with special nerve-supply and often with a ganglion or a single nerve-cell at the base.

The **organs of excretion** of the Chætopoda are a series of segmentally arranged tubes, the *nephridia*, of which a pair as a rule occur in each of the segments of the body with the exception usually of a few at the anterior and a few at the posterior end. In its simplest form the nephridium is a curved tube, primarily ectodermal in origin, ciliated internally, opening on the exterior by a laterally-placed pore at the one extremity, and at the other ending in a ciliated funnel or *nephrostome*, which opens into the cœlome either of the same segment as that on which the external aperture

is situated (most Polychæta) or of the segment in front (all or most Oligochæta, some Polychæta). The nephridia thus in such cases effect a communication between the cœlome and the exterior, and serve to carry off waste-products which have passed into the cœlomic fluid; but in many instances the cells lining the tube are active in separating out such waste-matters, and are loaded with granules and concretions.

In many Polychæta, however, there is no ciliated cœlomic aperture, the tube ending blindly internally, such a blindly ending nephridium (Fig. 382) being frequently branched. On the inner extremities in such cases, or on other parts of the tube, are situated a number of peculiarly modified cells, the *solenocytes*, sometimes separate, sometimes united together in groups. Each of these is a rounded cell lying in the cœlome, and connected with the nephridium by a long, slender, tubular process: through the

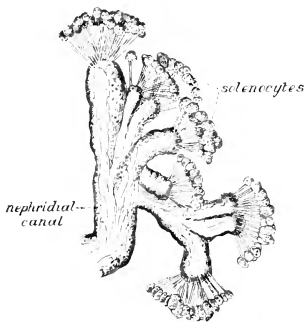

FIG. 382.—Inner branched end of nephridium of *Phyllodoce paretii*, showing the nephridial canal and the solenocytes. (After Goodrich.)

lumen of the process extends a single, extremely long, vibratile flagellum, which may be prolonged for some distance in the interior of the nephridium itself. The resemblance between these solenocytes and the flame-cells of Platyhelminthes will at once be recognised.

In the Polychæta another set of segmentally repeated structures are frequently intimately connected with the nephridia. These are a series of pairs of ciliated funnels, the *cœlomoducts*, opening widely into the cœlome, and,

in a typical case, communicating with the exterior. In *Nereis* they are represented by the dorsal ciliated organ, and are not known to open externally. When provided with external apertures, as is usually the case, the cœlomoducts act as the efferent ducts for the sexual elements. In many of the Polychæta they do not remain independent, but coalesce partially or completely with the nephridia, and the functions of excretory organs and reproductive ducts become combined in the one set of "segmental organs" (Fig. 383). In some families of Polychæta (*Serpula* and allies) there is a single pair of large nephridia in the anterior region of the body, with smaller pairs in the posterior segments, the former alone appearing to have an excretory function, while the latter act exclusively as genital ducts. In *Sternaspis* only a single pair of nephridia are present, which, though they have

small ciliated funnels, are not known to communicate with the exterior.

In the Oligochaeta the nephridia are usually simple, elongated and coiled tubes, a pair or sometimes more than one pair in each segment; but, in some, these are replaced or supplemented in certain of the segments, or, in all, by a branching system of tubes with or without ciliated funnels.

Sometimes the ordinary nephridia are not developed in the segments lodging the reproductive organs, their place being there taken by three pairs of tubes of the nature of localised coelomoducts which become modified to give rise to the reproductive ducts; but ordinary nephridia may be present in these segments as well. In some Oligochaeta the nephridia of the most anterior segments open into the mouth or pharynx, and have apparently taken on the function of digestive glands (*peptonenephridia*), and all the nephridia of the posterior region of the body in one species (*Allolobophora antipæ*), instead of opening on the exterior, communicate with a pair of longitudinal canals which posteriorly open into a median vesicle communicating with the rectum.

The permanent nephridia of the adult Chætopod are preceded in the larva by *provisional* or *embryonic nephridia* of a temporary character. These have been found to occur in the head (prostomium) of many larval Oligochaeta and Polychæta. They are ciliated intracellular tubes, sometimes branched, which do not open into the cavity of the prostomium. Sometimes solenocytes occur at the inner ends of the branches or of the undivided tube. Embryonic nephridia have also been shown to occur in the body in certain forms.

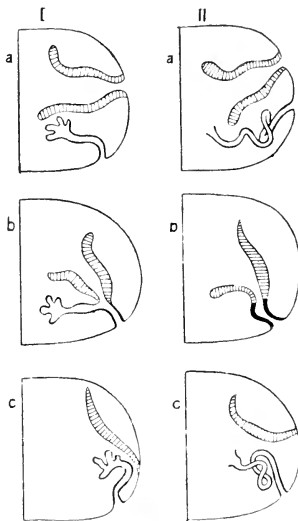

FIG. 383.—Diagram to illustrate the various combinations of closed and open **nephridia** and **coelomoducts** in the Polychæta. Ia, hypothetical stage with closed nephridia and separate coelomoducts; b, condition in which the coelomoducts have become united with the nephridia; this occurs in *Phyllo-docidae* and *Gonadidae*; c, condition in which the coelomoduct becomes reduced to a ciliated organ (*Nephtyidae*); IIa, combination of nephridia with nephrostomes and separate coelomoducts (*Dasybranchius*); b, condition in which "segmental organs" are formed by the union of nephridia with nephrostomes and coelomoducts (the most usual condition); c, condition in which there are nephridia with nephrostomes, and the coelomoducts are reduced to ciliated organs (*Nereis*, etc.). The nephridia are outlined with a thick line; the coelomoducts striated. (After Goodrich.)

Phosphorescence, the production of light rendering the animal brilliantly luminous in the dark, occurs in a few cases (various Polynoids, *Chatopterus*, &c.). In some of these (*Polyophthalmus*) the light is produced by eye-like organs in most of the segments.

In the arrangement of the **reproductive organs** in the Chætopoda there is an essential difference between the two subclasses, the Oligochæta being hermaphrodite, and the Polychæta, with only a very few exceptions, unisexual. In the latter the *gonads*, ovaries or testes as the case may be, are masses of cells which are developed as the result of a proliferation of the cœlomic

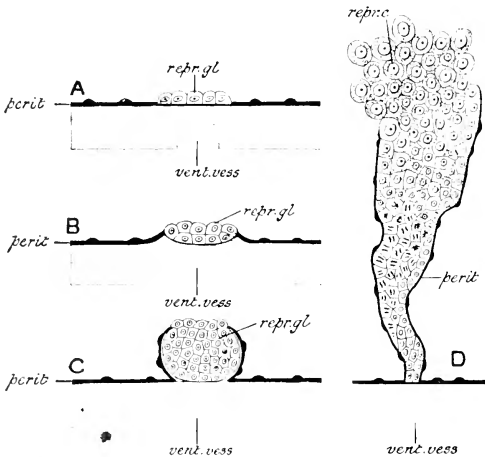

FIG. 384. —Diagram to illustrate the development of a gonad from the peritoneal (cœlomic) epithelium in one of the Polychæta. *perit*, peritoneal membrane; *repr. gl.*, gonad (reproductive organ); *vent. vess.*, ventral vessel. (After E. Meyer.)

epithelium in certain positions (Fig. 384). Usually these organs, which are only conspicuous about the breeding season, occur in the great majority of the segments of the body; sometimes they are confined to a certain region. The exact place which they occupy in the interior of the segment varies in different cases: sometimes they surround one of the principal blood-vessels, sometimes they are situated laterally, in the bases of the parapodia. The sperms frequently undergo the final stages of their development after they have become detached from the testes, while floating in the cœlomic fluid, and the same sometimes holds good of the ova. Both sperms and ova appear to reach the exterior, in the majority of cases, through the "segmental organs,"

which may become modified and enlarged at the breeding season, though in some forms it is stated that the reproductive cells escape through temporary or permanent openings in the body-wall. Impregnation takes place externally in nearly all.

In the Oligochæta the reproductive organs are confined to a certain limited region of the body. There are either, as in the Earthworms, two pairs of *testes*, or a single pair, as in the aquatic forms. The testes are small, and frequently become reduced to mere vestiges in the adult animal, having mainly become broken up into sperm-mother-cells, which in some way reach the *vesiculæ seminales* to undergo development into mature sperms. The *vesiculæ seminales* are comparatively large sacs, which vary in number and arrangement in the different genera. One or two median *sperm-reservoirs*, formed by the coalescence of pairs of vesiculæ, may be present. In the same segments as the testes, and opening into the sperm-reservoirs when the latter are developed, are either two or four *ciliated funnels*, according to the number of the testes, leading into efferent ducts. All the four ducts, when four are present, may remain distinct, or the two ducts of each side may open into a common atrium, or they may unite to form a common elongated *vas deferens*, opening at the male genital aperture. In connection with the terminal part of each vas deferens in many Oligochæts is a gland known as the *prostate* or *spermiducal gland*. Near the aperture of the vas deferens in many Earthworms are special setæ, the *penial setæ*.

There are never more than two *ovaries*, which, like the testes, are of very small size. The ova may become mature in the ovary, or groups of cells may be detached from the latter and one cell in each group ripen into an ovum. A *receptaculum ovarum* occasionally receives the ova after they leave the ovary. There are two *oviducts*, which open by funnel-shaped apertures into the cœlome. *Receptacula seminis* are present.

Development.—The Oligochæta deposit the eggs in *cocoons*, either buried in the earth or attached to water-plants. The cocoon contains, in addition to a number of fertilised ova, a quantity of an albuminous fluid which serves as nourishment to the developing embryos. Segmentation is always unequal. In the forms in which food-yolk is scanty there is a process of embolic invagination (*Lumbricus rubellus*); in the others (*Tubifex*, &c.) the process is of the epibolic type. In the former case a blastula and an invaginate gastrula are formed in the way already described in the case of the Earthworm. In *Lumbricus trapezoides* the gastrula divides into two, each half subsequently giving rise to an embryo. The micromeres spread over the megameres very much as in the Polychæta. A pair of mesoderm cells early appears, and by their division forms the mesoderm bands. No free larval stage similar to the trochophore occurs in any of the Oligochæta,

but the stage intervening between the completion of the gastrula and the commencement of the segmentation of the mesoderm bands corresponds to the trochophore in essential respects; and in some forms there is recognisable a feebly developed circlet of cilia comparable to the prototroch, and in some a pair of head-nephridia.

Impregnation and the development of the embryo take place

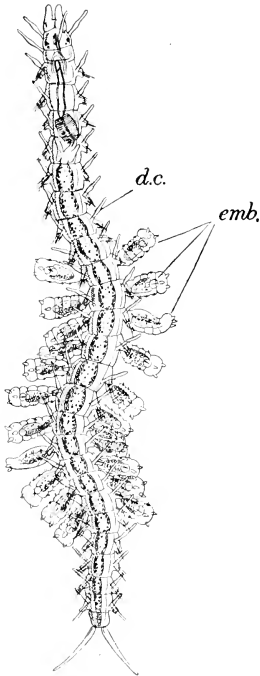

FIG. 385. — *Pionosyllis elegans*. Dorsal view of female with advanced embryos attached to the ventral surface. *d. c.* dorsal cirri; *emb.* embryos. (From Potts, after Pierantoni.)

externally in all the Chætopoda, with a very few exceptions in which development occurs in the cœlome or in the interior of a dilated segmental organ. In the Polychæta, in the great majority of cases, fertilisation takes place by the sperms coming in contact with the ova when both have become discharged, and the development of the embryos goes on while they are floating freely in the sea. There are a few cases in which the impregnated ova are received into a sort of brood-pouch and there pass through at least the earlier stages of their development. Such a brood-pouch is formed in certain Phanerocephala by the raising up of the integument on the ventral surface. In some species of Polynœe and allied genera, the fertilised ova and the resulting embryos adhere in masses to the dorsal surface under the shelter of the elytra; in some other Polychæta (certain Syllidea) they are stuck by means of a viscid secretion to the dorsal or the ventral surface (Fig. 385), or to the cirri. In certain Cryptocephala (Fig. 386) they develop in a cavity in the operculum; in others, in the interior of the tube, between the body of the worm and the inner surface of the latter, or on its outer surface. In some, again, though the ova do not remain in any way attached to the parent worm, they may be deposited in clumps or packets enclosed in gelatinous matter. Usually they have no other covering but the egg-membrane.

The segmentation of the ovum in the Polychæta is unequal. In the great majority the inequality between the megameres and

micromeres is very marked. In some Serpulids, however, the difference is very slight, and the two sets of cells are at first scarcely distinguishable. In such cases the cells arrange themselves in such a way as to form the wall of a hollow sphere, the *blastula*,

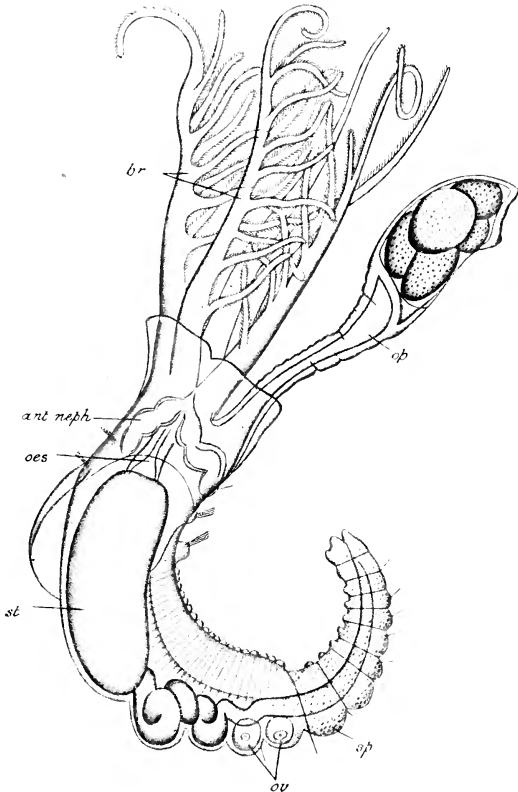

FIG. 386.—*Spirorbis laevis*, a hermaphrodite tubicolous Polychaet. Lateral view of entire animal. *ant. neph.* anterior nephridium; *br.* branchiae; *oes.* oesophagus; *op.* operculum with developing embryos in its interior; *ov.* ova; *sp.* sperms; *st.* stomach. (After Claparède.)

with an internal closed cavity, the *segmentation-cavity*. The megameres, which may or may not have been distinct from the first, lie on one side of the blastula; and soon this side becomes invaginated (Fig. 387, *A*), the result being the formation of an

embolic gastrula. In the great majority of forms, however, an *epibolic gastrula* is formed after the manner already described in the case of *Nereis*; but forms of the process of gastrulation intermediate between these two extremes have been observed. The blastopore of the gastrula, however formed, does not usually give rise directly either to the mouth or to the anus. It becomes elongated into a slit which becomes closed up, and the anus and proctodæum are formed by a fresh invagination in the original position of its posterior end, while another invagination of the ectoderm further forwards gives rise to the mouth and stomodæum. The embryo then passes into the *trochophore* stage.

The arrangement of the cilia on the surface of the trochophore varies in different Polychæta. Sometimes, though rarely, the

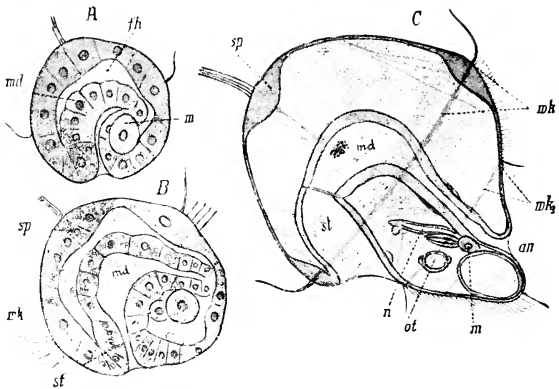

FIG. 387.—A, B, C, three stages in the development of the trochophore of *Eupomatus*, from the side. *an*, anus; *fh*, blastopore; *m*, polar cells of the mesoderm; *ml*, mid-gut; *n*, larval head-nephridium; *ot*, otolith; *sp*, neural plate; *st*, stomodæum; *mk*, pre-oral ciliated ring; *mk₂*, post-oral ciliated ring. (From Lang's *Comparative Anatomy*, after Hatschek.)

pre-oral circle is absent and the surface is covered uniformly with cilia in addition to an apical tuft: such larvæ are said to be *atrochal*. Typically there are two circlelets close together, the one *pre-oral*, immediately in front of the mouth, and the other *post-oral*, immediately behind it. Sometimes, in addition to the pre-oral circlelet, there is a *peri-anal circlelet* round the anal end (*telotrochal* larvæ). In some cases the pre-oral circlelet is absent and the post-oral is situated about the middle of the body (*mesotrochal*), or there may be several between the mouth and the anal end (*polytrochal*).

The post-oral portion of the larva elongates, and traces of segmentation become visible; sometimes a series of constrictions are developed before there is any trace of parapodia, sometimes rudiments of the latter with their setæ are developed first. The

number of segments, at first very small, becomes added to from behind as the body gradually elongates. The establishment of external segmentation is accompanied by the division of the mesoderm bands into a series of segments, the history of which has been sketched in describing the development of *Nereis*. The ectoderm of the ventral plate develops a median thickening which gives rise to the ventral nerve-cord. Anteriorly this becomes connected by a pair of thickenings at the sides of the mouth—the rudiments of the œsophageal connectives—with the developing cerebral ganglion.

The completion of metamorphosis is brought about by the increase in length of the body and concomitant increase in the number of segments, by the full development of the various systems of internal organs, and by the formation of the tentacles and other appendages. The parapodia, when first formed, very usually bear relatively long *provisional setæ*, which are subsequently thrown off to make way for those of the adult.

Asexual reproduction by simple fission followed by regeneration of the lost segments, or by proliferation followed by fission, occurs in certain groups of Chætopoda both among the Oligochæta and the Polychæta. Simple fission occurs in *Salmacina*, one of the Serpulids: a constriction becomes formed at a certain point towards the posterior end, rudiments of a new set of cephalic branchiæ bud out on one side at this point, and this posterior part becomes a distinct zooid, which is eventually separated off and develops the full number of segments characteristic of the adult. This is not in any way a case of alternation of generations, as both parent and offspring are similar and sexual (hermaphrodite). In *Nais* and *Chatogaster* (Oligochæta) there is multiplication by proliferation of the segments at the posterior end; then the appearance of a constriction separating off five or six of the most posterior segments followed by a fresh proliferation in front of the constriction; and then a second constriction appears five or six segments further forwards—the result being the development of a chain of zooids which remain for a time connected together. The sexual cells become fully developed only after the zooids have separated from one another.

In some of the Syllidæ there is a distinct *alternation of generations*. The asexual worm developed from the ovum gives rise by a process of posterior proliferation and constriction (Fig. 388) to sexual zooids, a number of which may remain for a time connected together

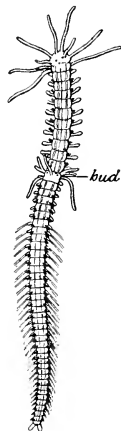

FIG. 388.—Budding in one of the Syllidæ (*Autolytus cornutus*); parent stock with a male zooid (bud) nearly ready to become detached. (After Agassiz.)

in a string before undergoing separation. These sexual zooids become developed into mature males or females, which may be remarkably unlike the parent form in the shape of the parapodia,

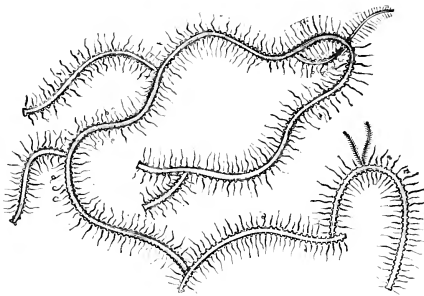

FIG. 389.—Portion of *Syllis ramosa*. (From the *Cambridge Natural History*, after McIntosh.)

the character of the setæ, and other points; and in some instances the two sexes not only differ from the asexual parent form but also from one another, so that the three forms, before their relationship was known, were set down as representing three distinct genera.

Syllis ramosa

(Fig. 389), which occurs in the interior of certain deep-sea sponges, is exceptional among the Chætopoda in giving rise by lateral branching to a colony from which sexual zooids afterwards become separated off.

Modes of Life, etc.—Very few Chætopoda are true *parasites*; but a considerable number are to be set down as *commensals*, habitually associating with another animal for the sake of food and shelter. The Earthworms burrow in soil containing decaying vegetable matter, passing the mould through their intestine and subsequently throwing it out in the shape of castings on the surface. They also feed on decaying leaves, and sometimes on animal substances. Some of the fresh-water Oligochæta (*Tubificida*) manufacture tubes of mud held together by a tenacious secretion from the epidermal unicellular glands. Some of the Phanerocephala form temporary tubes of a gelatinous character, or more permanent parchment-like tubes sometimes strengthened by means of agglutinated sand-grains. But the majority of the Phanerocephala, which for the most part prey on other small animals, are not confined to tubes, but move about



FIG. 390.—*Serpula* with their tubes. (After Quatrefages.)

freely. Some burrow in sand ; others even in harder substances, such as the shells of Mollusca, or in limestone, shale, or sandstone. Many *Cryptocephala* secrete tubes the substance of which is derived from the epidermal glands. These tubes are sometimes membranous or parchment-like, sometimes membranous but hardened by the deposition of grains of sand or particles of broken shells or bits of sea-weed ; sometimes (Fig. 390) they are of a hard, shelly, calcareous character, sometimes composed entirely of foreign particles cemented together ; very frequently they are permanently fixed to foreign objects. Some, such as species of *Polydora* and *Stylarioides*, near relatives of which construct tubes, excavate galleries in rock or coral or in the shells of various Mollusca.

A few Polychæta, such as the *Alciopidæ* and *Tomopteris*, as well as, in a certain phase, the *Nereidæ* and *Syllidæ*, are pelagic ; but the majority live on the sea-bottom. They occur in the greatest abundance near the shore ; but are also found at all depths in the ocean, the tube-dwelling forms being more abundant than the free forms in the deeper zones.

Owing to the soft character of most of their parts, there are comparatively few actual remains of Chætopoda in the older geological formations, though there are many burrows and tracks which have been ascribed to members of that class. Tubes of tubicolous Polychæta have, however, been found in formations dating from the Cambrian period onwards. Some tubes, not distinguishable from those of the existing genus *Spirorbis*, are found as far back as the Silurian ; and others, apparently closely related to the living *Serpula*, as far back as the Carboniferous. In addition there are a number of tubes of extinct forms ascribed to the tubicolous Polychæta. The horny jaws of various Polychæta have been detected in strata from the Cambrian period onwards ; and many tracks and burrows occurring in rocks of all ages are ascribed, some with more, some with less certainty, to this group of worms. No fossil remains of Oligochæta are known.

APPENDIX I. TO THE CHÆTOPODA.

CLASS MYZOSTOMIDA.

The *Myzostomida* are a group of worms which appear to have their nearest relatives in the Chætopoda, though possessing certain special features of their own. They are all external, or, in one case, internal, parasites of various Crinoids—both of the stalked and the free varieties, or internal parasites of certain Starfishes. They are disc-shaped animals (Fig. 391) (elongated in *Stelechopus*) devoid of any trace of external segmentation. There are patches of cilia here and there on both dorsal and ventral surfaces. At the sides there are five pairs of parapodia (*p*), each with a chitinous hook and

a supporting rod; in the intervals between these there are in *Myzostoma* four pairs of small "suckers"; and round the margin are a series of ten or more pairs of cirri provided terminally with motionless sensory cilia, and with a ventral groove lined by adhesive cells. The mouth, usually situated at the anterior extremity, leads into a muscular pharynx (Fig. 392, *ph.*) capable of being protruded as a proboscis; from this a narrow œsophagus leads to the stomach, which gives off a number of branched lateral diverticula (*da.*). A short cloaca (*klo.*) leading from the stomach opens on the exterior,

in most cases at the posterior end of the body, sometimes on the dorsal surface. There is no distinct cœlome, the space between the alimentary canal and the body-wall being filled by connective-tissue (parenchyma), leaving only the cavities in which the sexual elements are lodged. Bundles of dorso-ventral muscular fibres form imperfect transverse septa, as in some Platyhelminthes.

There is no blood-vascular system, and specialised organs of respiration are likewise wanting. There is a single pair of nephridia with funnel-shaped internal apertures and with external openings either into the cloaca or on the surface. The

[FIG. 391.—*Myzostoma*. 1—X, cirri; *m.* mouth; *p.* parapodia; *s.* suckers. (After von Graff.)

nervous system comprises a large stellate ganglion situated ventrally, probably representing a number of fused ganglia, and giving off a number of nerves; and two nerve-rings, one round the œsophagus, the other round the pharynx, the two rings being connected together by a series of longitudinal nerves. The œsophageal ring presents a very obscure dorsal thickening, which is the only representative of a cerebral ganglion.

Most of the *Myzostomida* are hermaphrodite. There is a pair of ovaries formed by the proliferation of the layer of (cœlomic) epithelium covering the stomach; and in the sexually mature

animal branching (cœlomic) spaces in the parenchyma, between the cæca, are found to be filled with ova (*o*). A posterior continuation of these spaces (*u*) opens either into the cloaca or independently of it. There are two elongated and usually branched testes (*h*), each of which has a vas deferens leading to a vesicula seminalis (*sb*) which opens near the lateral margin. In the hermaphrodite forms the testes are matured before the ovaries, and may have ceased to be functional before the ova become ripe.

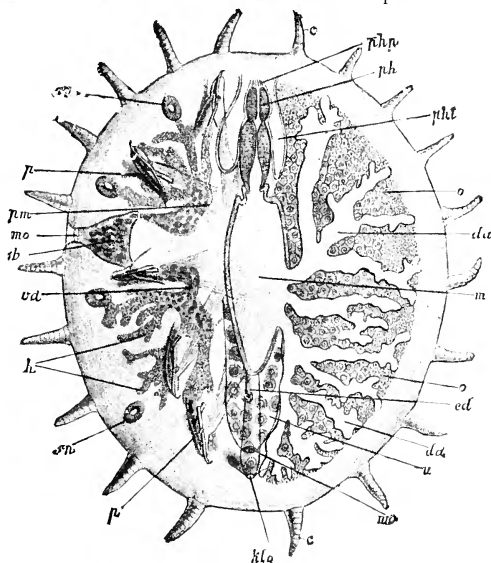

FIG. 392.—**Myzostoma.** Diagrammatic view of the internal organs, *c*, cirri; *da*, branches of the stomach; *ed*, hind-gut; *h*, testes; *kl*, aperture of cloaca; *m*, stomach; *mo*, male genital aperture; *o*, ovaries; *p*, parapodia, with hooks and supporting rod; *ph*, pharynx; *php*, pharyngeal tentacles; *phl*, pharyngeal pouch; *sb*, vesicula seminalis; *sn*, suckers; *u*, uterus; *ud*, female genital aperture. (From Lang's *Comparative Anatomy*, after von Graff.)

The development of the Myzostomida closely resembles that of the Polychæta. A trochophore larva is first formed, and this becomes metamorphosed into a larva with provisional setæ bearing a close resemblance to that of Nereis (p. 443).

APPENDIX II. TO THE CHÆTOPODA.

CLASS ECHIURIDA.

The Echiurida are a small group of marine worms including the genera *Echiurus*, *Thalassema*, *Bonellia*, *Pseudobonellia*, *Hamingia*,

Saccosoma, and *Epithetosoma*. They are unsegmented in the adult condition and have no parapodia, but, except in the case of *Saccosoma*, have a pair of ventral setæ in one or both sexes. The general shape is cylindrical or ovoid, with the mouth anterior and the anus posterior. Overhanging the mouth is a median appendage usually termed the *proboscis* (absent in *Saccosoma*). This is sometimes of great length, sometimes comparatively short, and is highly sensitive and mobile, but is not retractile. In some cases it contains a cavity communicating with the cœlome. There is a wide cœlome undivided by mesenteries, but crossed by numerous muscular strands which support the alimentary canal. The alimentary

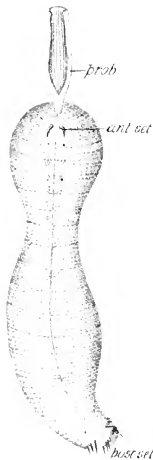

FIG. 393.—*Echiurus*, entire animal. *ant. set.*, anterior setæ; *post. set.*, posterior setæ; *prob.*, proboscis. (After Greef.)

canal is a greatly coiled tube with a short thick-walled pharynx in front and an ovoid rectum behind. With the intestine communicates at both ends an elongated tube—the *siphon*, comparable to that of the Echinoids—and a ciliated groove runs throughout its length. There is a closed blood-vascular system with a peri-intestinal sinus, a dorsal vessel, and a ventral vessel. The most important part of the nervous system (Fig. 395) takes the form of an unsegmented ventral nerve-cord giving off pairs of nerves. In front this bifurcates, and the two cords resulting from the division running forwards past the mouth, extend throughout the length of the proboscis, at the anterior extremity of which they unite to form a great loop which shows no trace of ganglia. There are no organs of special sense. Into the rectum open a pair of cæca—the *anal vesicles* or *posterior nephridia*, which are probably the chief excretory organs. These have appended to them a number of ciliated funnels which open into them from the cœlome. Further forward there is a pair of nephridia, one of which may be aborted, or there may be two or three pairs. The sexes are distinct and there may be extreme

sexual dimorphism. The larva is a trochophore.

Echiurus (Fig. 393) is approximately cylindrical, with a moderately long proboscis which is excavated longitudinally on the ventral surface by a ciliated channel at the posterior end of which the mouth is situated. The surface is covered with small papillæ arranged in rings. On the ventral surface not far from the anterior end is a pair of short simple pointed setæ (*ant. set.*), each lodged in a setigerous sac and capable of being moved freely by means of appropriate muscles. Surrounding the posterior (*anal*) end of the body are a number of setæ (*post. set.*) arranged in one or two rings.

The anal vesicles or posterior nephridia (Fig. 394, *post. neph*) are narrow and elongated, and their funnels are sessile. There is a pair of anterior nephridia (*ant. neph*) with nephrostomes and nephridiopores situated ventrally behind the setæ. The sexes are alike and the ovary or testis is a ventrally situated median mass of cells in the posterior half of the cœlome. The anterior nephridia act as genital ducts.

Thalassema is allied to *Echiurus*, but has a shorter proboscis and no peri-anal setæ. There are from one to three pairs of anterior nephridia.

Bonellia (Fig. 396) is ovoid in shape and green in colour, and is covered with large papillæ which are not arranged in rings. The

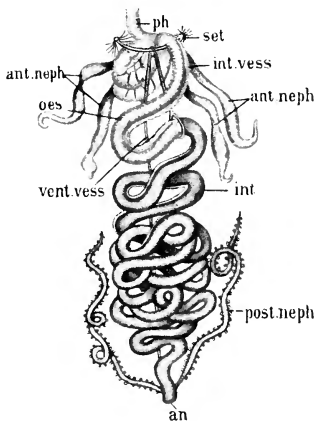

FIG. 394.—*Echiurus*, internal organisation. *an.* anus; *ant. neph.* anterior nephridia; *int.* intestine; *int. vess.* intestinal vessel; *oes.* oesophagus; *post. neph.* posterior nephridia; *set.* setigerous sacs; *vent. vess.* ventral vessel. (After Greef.)

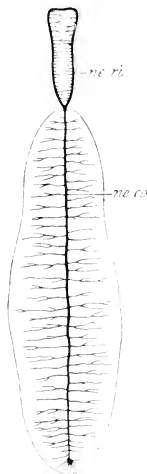

FIG. 395.—*Echiurus*, general outline of the animal, with the nervous system (diagrammatic). *ne. co.* nerve-cord; *ne. ri.* nerve-ring. (After Greef.)

proboscis is very long and very extensible, and bifurcated terminally. There are two ventral setæ, sometimes more. There is only one anterior nephridium (Fig. 397, *ant. neph*) which is greatly enlarged and acts as a uterus. The anal vesicles (*post. neph*) are ovoid, and the funnels terminate the branches of narrow branching tubes given off from the main vesicles. It is the female which has these characters: the male (Fig. 399) is minute, Turbellarian-like, ciliated, with in most species a pair of setæ, no proboscis, and a reduced alimentary canal without mouth or anus. In the young

condition it enters the pharynx of the female and when sexually mature establishes itself permanently in the nephridium.

Pseudobonellia is nearly related to *Bonellia*, but has two anterior

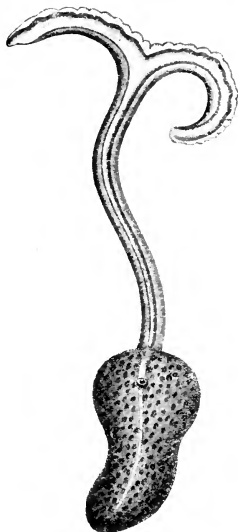

FIG. 396.—*Bonellia viridis*, entire animal (female) with the proboscis moderately extended. (After Greef.)

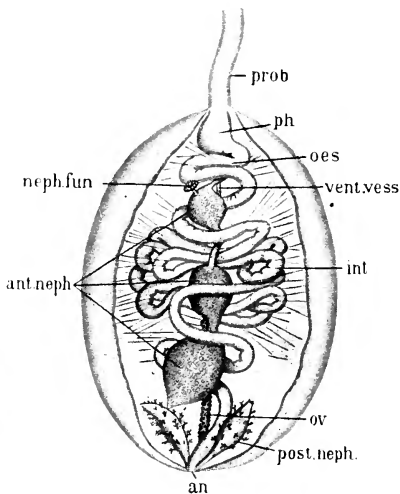

FIG. 397.—*Bonellia*, general view of the internal organs. *an.* anus; *ant. neph.* anterior nephridium; *int.* intestine; *neph. fun.* nephrotoxic funnels; *oes.* oesophagus; *ov.* ovary; *ph.* pharynx; *post. neph.* posterior nephridium; *prob.* proboscis; *vent. vess.* ventral vessel. (After Greef.)

nephridia (uteri). The degenerate male, which has no setæ, lies in a median pit opening on the ventral surface between the two uteri.

Hamingia has a general resemblance as regards the female to *Thalassema*, but there are no setæ. There are two anterior nephridia. The male, which has two setæ, is degenerate and parasitic in the female, as in *Bonellia*.

Acanthohamingia has eight small setæ.

Epithetosoma has an extremely long filiform proboscis which, unlike that of the other genera, is hollow, containing a prolongation of the cœlome. There are no setæ. There is a single nephridium and no anal vesicles.

In *Saccosoma* both proboscis and setæ appear to be absent. The male is not known.

Development.—The larva of *Echiurus* (Fig. 400) has a well-developed pre-oral

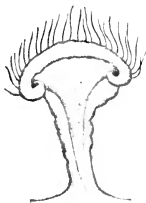

FIG. 398.—One of the ciliated funnels of the posterior nephridium of *Echiurus*. (After Greef.)

lobe with pre-oral and post-oral circlets of cilia, and in other respects closely resembles the trochophore embryo of a Chaetopod. The posterior part of the body elongates, and the mesoderm-bands, developed as in the Chaetopoda, become divided into as many as fifteen segments. A circlet of setæ is developed at the anal end, and subsequently the two ventral setæ are formed in the same manner as in the Chaetopoda. The pre-oral lobe becomes narrowed to form the cylindrical proboscis of the adult; and the rudimentary segmentation gradually disappears as development advances.

In *Bonellia* there is unequal segmentation, as in most Chaetopoda, resulting in the formation of four large megameres and eight small

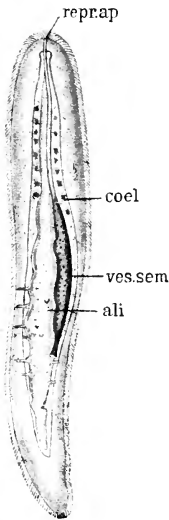

FIG. 399.—Male of *Bonellia*. *ali*, alimentary-canal; *coel*, groups of colomic cells destined to give rise to sperms; *repr. ap.* reproductive aperture; *ves. sem.* vesicula seminalis. (After Greef.)

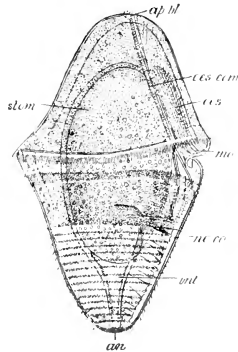

FIG. 400.—Trochophore of *Echiurus*, *an.* anus; *ap. pl.* apical plate; *int.* intestine; *mo.* mouth; *n. co.* rudiment of nerve-cord; *æs.* œsophagus; *æs. conn.* œsophageal connective; *stom.* stomach. (After Hatschek.)

micromeres: the latter multiply rapidly, and grow over the megameres so as eventually to enclose the latter in a complete layer of ectoderm, save at one point, where there is a gap, the *blastopore*. Here the ectoderm bends inwards to give rise to a continuous mesoderm layer superficial to the megameres. The blastopore soon closes up. The megameres divide to form the cells of the endoderm, among which a lumen only appears comparatively late; mouth and œsophagus are developed as an outgrowth, at first solid, from the endoderm. The anus becomes formed still later by invagination at the hinder end of the body; and a pair of epidermal

vesicles which appear at its sides, developed as outgrowths from the terminal part of the intestine, form the rudiments of the posterior nephridia. A rudimentary pre-oral lobe becomes established. The mesoderm remains unsegmented, but splits into somatic and splanchnic layers going to form the muscular system, blood-vessels, and other mesodermal organs. Before the alimentary canal is formed the larva, which had previously been spherical with two bands of cilia and a pair of eye-spots, becomes elongated and dorso-ventrally compressed, and covered uniformly with cilia, so as to present the general appearance of a Planarian. It becomes converted into the adult female by a metamorphosis, including the elongation of the pre-oral lobe to form the proboscis and the development of the pair of setæ of the adult. The male never goes through this metamorphosis, but remains in the Planarian stage: it at first adheres to the proboscis of a female, then enters the œsophagus, and afterwards, when sexually mature, passes into the cavity of the nephridium.

CLASS II.—SIPUNCULOIDEA.

The *Sipunculoidea* are marine Annulata devoid of any trace of segmentation in the adult condition, without parapodia, and without setæ; with an invaginable anterior body-region or introvert, at the extremity of which is the mouth surrounded by tentacles. The anus is anterior and dorsal. There is an extensive cœlome filled with a corpusculated fluid, and not divided by septa. The ventral nerve-cord is not made up of a series of ganglia. There is, as a general rule, only a single pair of nephridia. The sexes are separate; the ovaries and testes simple masses of cells; the nephridia act as reproductive ducts. The larva is a modified trochophore.

1. EXAMPLE OF THE CLASS—*Sipunculus nudus*.

General External Features.—*Sipunculus* occurs on sand at moderate depths off the coast in most countries outside of the tropics. It is an elongated worm of a cylindrical shape, somewhat narrower towards one—the anterior—end. There is no trace of division into segments. The anterior portion of the body, to the extent of about a sixth of the total length, is capable of being involuted within the part behind. The surface of this anterior part, which is termed the *introvert* (Fig. 401), differs in appearance from that of the rest of the body in being covered more or less closely with chitinous papillæ. The papillæ of the posterior portion of the introvert are shaped like the bowl of a spoon, with the concavity turned towards the body-wall and the tip directed backwards; they are so closely arranged as to overlap one another like the shingles of the roof of a house: further back they become

longer and narrower, mammilliform, and more scattered. When the introvert is fully evaginated, there appears at its extremity a horse-shoe-shaped fold of the integument, the *tentacular fold* (*tent.*), which is lobed and plaited (Fig. 402) so as to assume somewhat the appearance of a cirlet of tentacles. For a little space immediately behind the tentacular fold the surface of the introvert is free from papillæ. The posterior portion of the body is devoid of papillæ, but is marked out by a series of narrow impressed lines into a number of elongated four-sided areas.

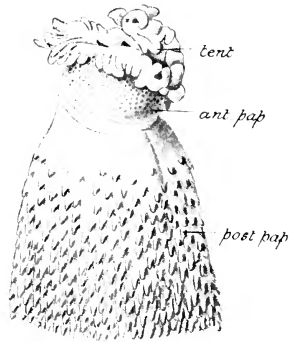

FIG. 401.—Anterior extremity of *Sipunculus nudus*. *ant. pap.* anterior papillary region; *post. pap.* posterior papillary region; *tent.* tentacular fold. (After Ward.)

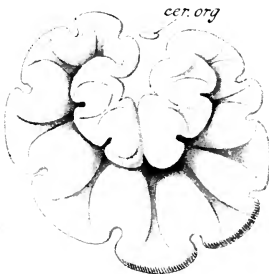

FIG. 402.—Tentacular fold of *Sipunculus nudus*. *cer. org.* cerebral organ. (After Ward.)

Body-wall. — The surface is covered by a chitinous *cuticle* having an iridescent lustre similar to that presented by the cuticle of *Nereis* and *Lumbricus*, and due to the same cause—viz., the presence of two systems of intercrossing lines. The papillæ on the introvert are local thickenings of this cuticular layer.

Beneath the cuticle is an *epidermis* consisting of a single layer of cells, usually sac-like, but capable of being altered as a result of contraction or compression into a spindle-like shape. Below the epidermis is a layer of connective-tissue, the *dermis*, in which, as well as to some extent in the epidermis itself, are a number of *dermal bodies*. Of these there are three kinds—*bicellular glands*, contained in papillæ; *multicellular glands*, scattered through the integument and not contained in papillæ; and *sense-papillæ*, small, rounded thickenings of the epidermis in the anterior region of the introvert, with their summits covered with cilia. There are also numerous pigment-cells. A number of canals branch through the dermis, beneath which are three

layers of muscle—(1) an outer *circular* layer, continuous in the introvert, but divided into annular bands in the rest of the body; (2) an *oblique* layer, well developed only between the origins of the two retractor muscles of the introvert; (3) a *longitudinal* layer

which is separated by spaces into a series of parallel bands. Between the bundles of the longitudinal layer of muscle runs a system of canals which communicate with the body-cavity by transverse branches.

There is a spacious **cœlome**, but it is traversed in all directions by filaments and strands of connective-tissue, with which are mixed very fine muscular fibres; these mostly run from the wall of the body to the alimentary canal. Floating in the cœlomic fluid are (1) colourless amœboid corpuscles; (2) rounded biconcave corpuscles, faintly coloured by a substance, *hamerythrin*,

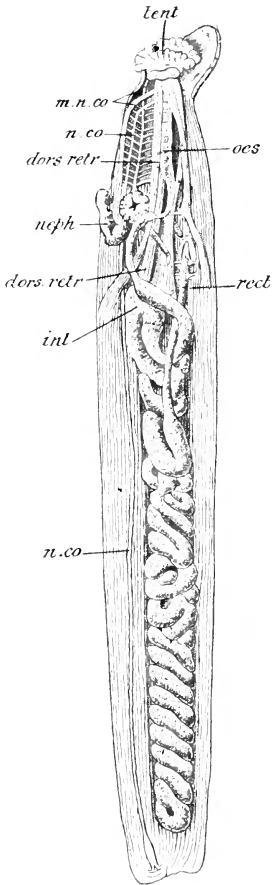

FIG. 103.—Dissection of the internal organs of *Sipunculus nudus*. *dors. retr.*, dorsal retractor muscles of the introvert; *int.*, intestine; *m. n. co.*, muscles accompanying the nerve-cord; *n. co.*, nerve-cord; *neph.*, nephridium; *oes.*, oesophagus; *rect.*, rectum; *tent.*, tentacular fold. (After Vogt and Jung.)

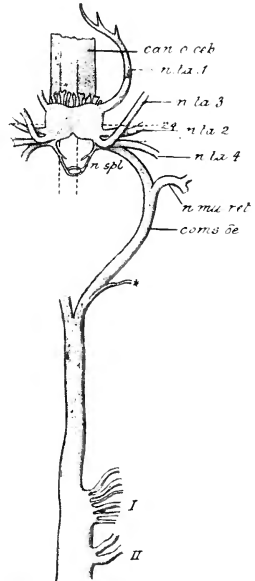

FIG. 404.—Anterior part of the nervous system of *Sipunculus nudus*. *can. o. ceb.*, cerebral organ; *coms. o.*, oesophageal connective; *n. mu. ret.*, nerves to retractor muscles; *n. spl.*, splanchnic nerves; *n. ta. 1-4*, nerves to tentacular fold; *I, II*, nerves from ventral cord; *24*, main mass of brain. (After Ward.)

which perhaps acts, like hæmoglobin in many animals, as a carrier of oxygen; (3) reproductive elements; (4) peculiar unicellular ciliated bodies, the *urns*, which are developed by proliferation from cells on the wall of the dorsal blood-vessel. These are comparable in structure and function with the ciliated funnels of the Hirudinea (*q.v.*).

The **blood-vascular system** is very feebly developed. It consists of *dorsal* and *ventral* contractile vessels, the former known as the "heart," communicating in front with a *circular sinus* at the base of the tentacular fold.

The **alimentary canal** (Fig. 403) is a cylindrical tube of uniform character throughout. It is twice the length of the body, running back from the mouth towards the posterior end, and then bending sharply round to run forwards to the anus, the two limbs being twisted spirally round one another. Running along the inner surface of the entire length of the alimentary canal, with the exception of the terminal part or rectum, is a narrow groove. Connected with the rectum is a narrow *cæcum* of variable length, which opens into the beginning of the rectum. Two tuft-like groups of *rectal glands* occur close to the anal opening.

The **nervous system** (Fig. 404) differs considerably from that of the rest of the Annulata. There is a relatively small bilobed *cerebral ganglion* situated on the dorsal aspect just behind the tentacular circlet, to which it gives off on each side several pairs of nerves. Arising from it anteriorly and dorsally are a number of digitate processes lying in the cœlome. The *oesophageal connectives* (*coms. œ*) which it gives off behind are greatly elongated; from each arise *muscular nerves* (*n. mu. ret*), and also a *visceral nerve* (*n. spl*) passing to the alimentary canal. The two commissures unite behind to form a *ventral cord*, which extends throughout the rest of the length of the body. The ventral cord presents no appearance of ganglia: it sends off laterally a large number of pairs of nerves (*I., II.*); on section it appears distinctly double. Two delicate muscular bands (Fig. 403, *m. n. co.*), which take origin anteriorly from the body-wall, become attached to the nerve-cord, and follow it throughout its length, giving off small branch-bands to accompany the lateral nerves. A canal with ciliated, folded and pigmented walls, which opens in the middle line of the dorsal surface just behind the tentacular fold (Fig. 402, *cer. org.*), extends backwards to the anterior ventral surface of the cerebral ganglion, where it ends blindly. It is possible that this, the *cerebral organ*, may be a sensory organ of some kind. *Eyes* are wanting. The digitate processes of the cerebral ganglion, which bear a number of ciliated cups along their edges, may be sensory in character.

Sipunculus has only a single pair of **nephridia**. These (Fig. 403, *ncph*) are situated tolerably far forwards, the external openings being about 2 cm. in front of the anus. They are long,

nearly straight tubes, of a brown or yellowish colour, and very mobile in the living condition. Near the external opening, which is situated at the anterior end, is the internal opening into the cœlome. The sexes are separate. There are no definite **gonads** except at a certain season of the year, when cellular elevations developed in the connective-tissue covering the ventral retractor muscles of the introvert represent *ovaries* or *testes* as the case may be. These give origin to cells which become detached and develop into the fully-formed sexual elements while floating about in the cœlomic fluid. The nephridia act as *gonoducts*.

2. DISTINCTIVE CHARACTERS.

The Sipunculoidea are Annulata with the body devoid of any appearance of segmentation in the adult condition. There is a large cœlome, which is not divided into chambers by mesenteries or septa. A blood-vascular system is sometimes present, sometimes absent. The ventral nerve-cord is not composed of a chain of ganglia. There is usually only one pair of nephridia. The sexes are separate, the gonads simple, and the nephridia act as gonoducts.

The larva is in most cases a trochophore.

3. GENERAL ORGANISATION.

The Sipunculoidea are a class of worms whose position among the Annulata is determined more from a consideration of their development than of their structure in the adult condition, though the latter suggests a tolerably close affinity with the Chætopoda. The body of a Gephyrean is unsegmented, usually more or less completely cylindrical, broadest behind and narrowing towards the anterior end. The surface is covered with a chitinous *cuticle* developed often into papillæ, or tubercles, or hooks. The anterior part of the body is capable of being invaginated within the part behind; at the extreme anterior end of this invaginable part or *introvert*, when it is evaginated, is the mouth, surrounded by a circlet of sometimes pinnate, sometimes simple, tentacles, or by a lobed and plaited *tentacular fold*. The prostomium is quite rudimentary. The *anus* lies far forwards on the dorsal surface.

Body-wall.—Beneath the cuticle is an *epidermis*, which is composed of a single layer of cells. Among the cells are unicellular (rarely multicellular) glands, and sensory cells. The muscular wall of the body consists of external circular and internal longitudinal layers, sometimes with oblique and internal circular layers superadded. There is an extensive undivided **cœlome**, lined, as in the case of the Chætopoda, with a cœlomic epithelium, which is sometimes ciliated. Apertures (stomata) lead from the cœlome into variously arranged systems of canals in the wall of the body.

The **alimentary canal** is not definitely divided into regions, but is a thin-walled tube, the oral part known as the *pharynx*, a slightly narrower part succeeding as the *oesophagus*, the greater part as the *intestine*, and the terminal part as the *rectum*. A ciliated groove runs throughout the length of the canal. The intestine is bent on itself, and spirally twisted as it runs forwards to the anal opening, which, as already noted, is situated far forwards on the dorsal surface: at the junction of intestine and rectum is a single simple cæcum or a pair of cæca; and a number of small branching glandular appendages are attached to the rectum close to the anal opening.

There are no specialised **organs of respiration** in the Sipunculoidea. A **blood-vascular system** is sometimes present, sometimes absent. When present, as it is in most, it usually comprises a contractile dorsal vessel closely applied to the intestine, and a peri-pharyngeal ring or plexus.

The **nervous system** (Fig. 404) consists of a nerve-ring, sometimes greatly elongated, surrounding the anterior part of the alimentary canal, with a dorsal and anterior thickening representing a *cerebral ganglion*; and of a *nerve-cord*, devoid of ganglia, running backwards from this along the middle of the ventral surface, and giving off pairs of branches at regular intervals. **Eyes** of a very simple character, consisting of mere spots of pigment, are present in some.

In the majority of cases there is a pair of **nephridia** or **brown tubes** which open externally on the ventral surface, and internally communicate with the cœlome by means of ciliated apertures, the form and position of which vary in different cases. They act as efferent ducts for the reproductive elements (*gonoducts*); but their function as excretory organs has not been definitely established. In many cases one of these is absent.

The sexes are usually distinct, and the **reproductive organs** are of very simple character, consisting merely of ridges or clumps of cells (*gonads*), sometimes enclosed in a membrane, developed at various points on the body-wall or on the wall of one of the main blood-vessels. The cells of these ovaries or testes may develop *in situ* into perfect ova or sperms; more usually they become detached, and undergo the later stages of their development while floating in the cœlomic fluid.

The early stages of the development closely resemble those of the embryo of one of the Polychæta, and a stage corresponding to the trochophore of that class is developed, but with the mouth situated further forward in front of the ring of cilia and with the anus in front of the posterior extremity on the dorsal side. At no stage in the development has any trace been observed of the temporary segmentation which forms so marked a feature in the development of Echinurus. But in at least one member of the

group the mesoderm undergoes segmentation, and the coelome is formed by the coalescence of cavities which appear in these segments.

Distribution, Affinities, etc.—The Sipunculoidea are all marine. They are only capable of very slow creeping locomotion, and live for the most part either in natural rock-fissures, or in interstices between masses of fixed animals such as mussels or ascidians, or in discarded shells of Mollusca or tubes of Polychæta, or in burrows which they excavate for themselves either in sand or mud, coral or rock. Their distribution is general; and they occur at considerable depths as well as in shallow water.

The resemblances between the Sipunculoidea and the Echiurida have been and are regarded by many authors as sufficiently important to justify the inclusion of both in one class to which the name Gephyrea was given. But apart from the embryological history, the introvert of the Sipunculoidea with its crown of tentacles, the forward dorsal position of the anus, and the absence of true setæ are all points in which the members of that class diverge from the Echiurida and the Chætopoda. At the same time it is in the Echiurida probably that the Sipunculoidea find their nearest known relatives.

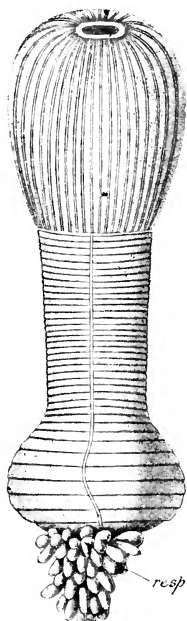

FIG. 405.—**Priapulus**, entire animal, *resp.* posterior papillæ. (After Ehlers.)

The *Priapuloidea*, often classed with the Sipunculoidea, may be mentioned here. *Priapulus* (Fig. 405), species of which have been found widely distributed at moderate depths in extra-tropical seas, is a cylindrical worm, unsegmented but with numerous superficial annulations in the posterior half. At the anterior end is the mouth and at the posterior the anus. There is a short introvert, but no oral tentacles or tentacular fold. At the posterior end is a hollow single or double process beset with hollow papillæ (*resp.*): the lumen of this is in communication with the coelome, and the whole apparatus is doubtless a respiratory organ or *branchia*. The alimentary canal, which is not coiled, consists of a muscular pharynx, a thin-walled intestine, and a rounded rectum. There is no blood-vascular system. The nervous system is in close connection with the epidermis: it consists of a simple ventral nerve-cord and a circum-oesophageal ring without brain-enlargement. The sexes are distinct. The ovaries or testes are a pair of masses of follicles each having its main duct which opens on the exterior close to the anus. The genital ducts with their branches seem to act as excretory organs. The development is unknown.

CLASS III.—ARCHI-ANNELIDA.

More primitive in some respects than the other Annulata are the Archi-Annulida, comprising only the family *Polygordiidae*. They are marine worms with narrow, elongated, cylindrical body. The prostomium (Fig. 406, *Pr. st*) is small, the peristomium (*Per. st*) large. The segments (*Mtmr*) are only faintly marked off externally for the most part, though the internal division of the coelome by means of septa is complete. Parapodia and setae are absent, but the prostomium bears a pair of tentacles (*t*). Several pairs of simple nephridia are present. The position of the nervous system (Fig. 408) is more primitive than in the Annulata in general; it is continuous with

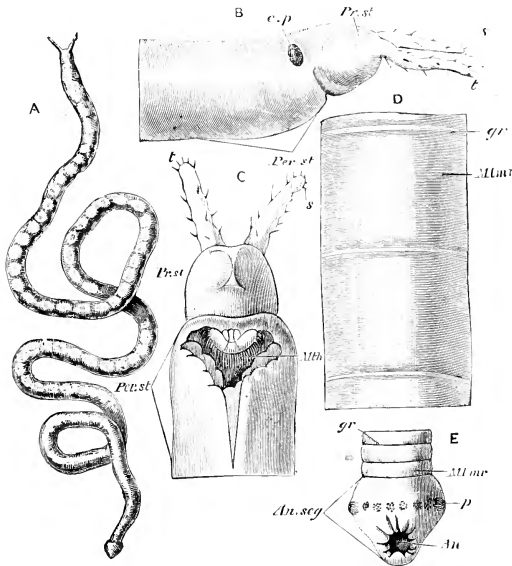

FIG. 406.—*Polygordius neapolitanus*. A, the living animal, dorsal aspect, about five times natural size; B, anterior end, lateral view; C, ventral view of the same; D, portion of the body showing the metamerous; E, ventral view of the posterior extremity; *An. anus*; *An. seg.* anal segment; *c. p.* ciliated pit; *gr.* grooves between metamerous; *Mth.* mouth; *Mtmr.* metamerous; *p.* papillae; *Per. st.* peristomium; *Pr. st.* prostomium; *s.* papillae on tentacles (*t*). (From Parker's *Biology*, after Fraipont.)

the epidermis, and not separated from it by mesodermal elements as in most of the others. A pair of ciliated grooves (*c. p.*) are probably to be looked upon as organs of special sense.

The family *Polygordiidae* includes two genera—*Polygordius* and *Protodrilus*. There are a pair of prostomial tentacles, long in *Protodrilus*, short in *Polygordius*, and a pair of ciliated pits. The segmentation is only very indistinctly marked externally in *Protodrilus* by circlets of cilia; in *Polygordius* it is indistinct in front, but better marked behind. In *Polygordius lacteus* a

series of tooth-like processes occur round the anus, and in front a circlet of adhesive papillæ. In *Protodrilus* there is a ventral ciliated groove. There is a vascular system with dorsal and ventral longitudinal vessels. In each segment is a pair of simple nephridia. In *Protodrilus* there are two ventral nerve-cords, connected together by transverse commissures; in *Polygordius* the cord (Fig. 408, *V. Nv. Cd*) is single; in neither genus is there any trace of ganglia. The sexes are united in most individuals of *Protodrilus*, ovaries occurring in all the first seven segments and testes in some of those immediately following. In *Polygordius* the sexes are separate; the ovaries or testes (Fig. 408, *Spy*) are developed in the posterior segments. There are no special reproductive ducts.

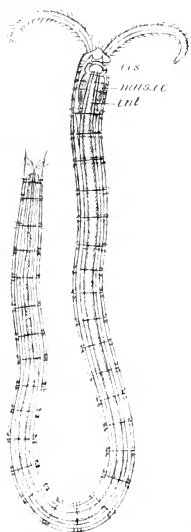

FIG. 407.—*Protodrilus*, entire animal. *int.* intestine; *mus. cc.* muscular appendage of oesophagus; *os.* oesophagus. (After Hatschek.)

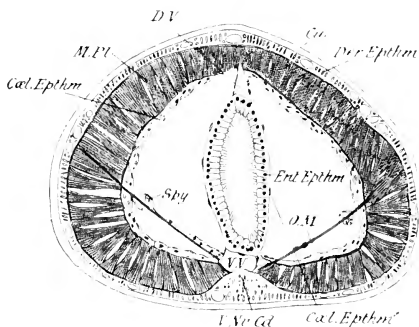

FIG. 408.—*Polygordius neapolitanus*, transverse section of a male specimen. *Coel. Epthm.* parietal layer of coelomic epithelium; *Cal. Epthm.* visceral or splanchnic layer of the same; *Cu.* cuticle; *Der. Epthm.* deric epithelium; *D. V.* dorsal vessel; *Ent. Epthm.* enteric epithelium; *M. PL.* muscle-plates; *O. M.* oblique muscles; *S. Py.* immature gonads; *V. Nv. Cd.* ventral nerve cord continuous with deric epithelium; *V. V.* ventral vessel. (From Parker's *Biologu*, after Fraipont.)

The larva of *Polygordius* is a typical trochophore (Fig. 409), and its metamorphosis into the adult worm (Fig. 410) takes place as in the Polychæta in all essential respects.

Ctenodrilus and its ally *Zeppelinia* resemble *Polygordius* in the ectodermal position of the nervous system and in the presence of ciliated pits; but they have a number of setæ on each segment, and only a single pair of nephridia, which are situated in the head. There is only a single (longitudinal) layer of muscles in the body-wall. *Ctenodrilus* multiplies asexually by fission, and is hermaphrodite and viviparous. Also sometimes supposed to be related to the Archi-annelids is *Nerilla*, a minute marine worm with parapodia and setæ and with hollow cirri. [Compare *Dinophilæa* and *Histriobdellea*, Section VII.]

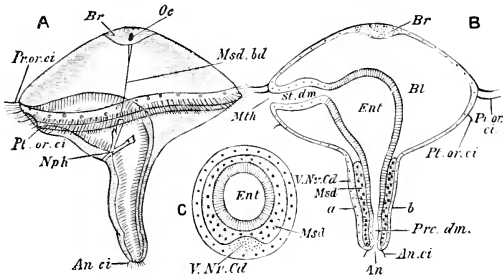

FIG. 409.—Trochophore of **Polygordius neapolitanus**. A, lateral view of entire larva; B, diagrammatic vertical section; C, transverse section through the plane *ab* in B; An. anus; An. ci. anal cilia; Bl. blastocoele; Br. apical plate; Ent. enteron; Msd. mesoderm; Msd. bd. mesodermal bands; Nph. head-kidney; Oc. eye-spot; Pr. or. ci. cilia of prototroch; Pre. dm. proctodæum; Pt. or. ci. post-oral cilia; St. dm. stomodæum; V. Nr. Cd. ventral nerve-cord. (From Parker's *Biology*, partly after Fraipont.)

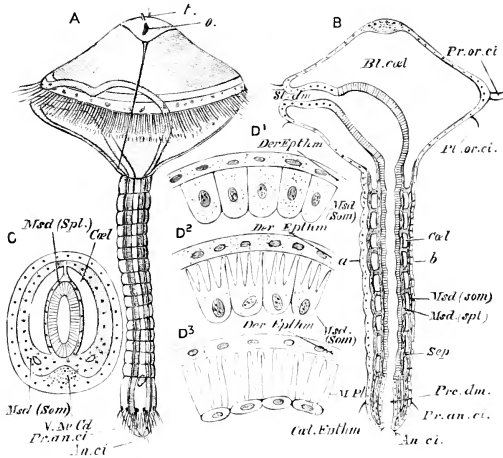

FIG. 410.—Later stage in the development of **Polygordius neapolitanus**, in which the posterior part of the trochophore has become elongated and segmented: A, entire larva; B, vertical section; C, transverse section along the plane *ab* in B; D¹—D³, three stages in the development of the somatic mesoderm; Col. colome; Cæl. Epith. colonic epithelium; Der. Epith. deric epithelium; M. pl. muscle-plate; Msd. (som), somatic mesoderm; Msd. (spl), splanchnic mesoderm; o. eye; t. tentacle. Other letters as in preceding figure. (From Parker's *Biology*, partly after Fraipont.)

CLASS IV. HIRUDINEA.

1. EXAMPLE OF THE CLASS—*The Medicinal Leech* (*Hirudo medicinalis* and *H. (Limnobdella) australis*).

The medicinal Leech is found in ponds, swamps, and slowly flowing streams in many parts of the world. *H. medicinalis* is the common British species: *H. australis* is an allied Australian form.

External Characters.—The Leech is a vermiform animal, some 6–10 cm. (2–3 inches) in length, but is capable of contracting and elongating itself so as to produce great alterations in form and proportions. It moves by “looping” movements, and is also a good swimmer. The body (Fig. 411) is depressed or flattened dorso-ventrally, the dorsal surface convex, the ventral flattened. The anterior end presents a ventrally directed cup-like hollow, the *anterior sucker* (*a. s.*), in the middle of which is a small aperture, the *mouth* (*nth.*). The hinder end bears a disc-like *posterior sucker* (*p. s.*), also directed downwards, and at its junction with the trunk, on the dorsal surface, is the very small median *anus* (*a.*). The animal is brightly coloured, the dorsal surface in *H. medicinalis* being longitudinally banded with alternate stripes of greenish-grey and rusty red, the ventral surface greenish-yellow, spotted with black: in *H. australis* the whole under-surface is rust-coloured.

The whole body is encircled by close-set transverse grooves, dividing it into *annuli*. These, like the annuli of some Earthworms, are more numerous than the true segments or metameres, the study of the internal organs showing that, except at the two extremities, each segment contains five annuli. There are also external characters by which the actual segmentation is plainly indicated. The rust-coloured streaks on the back of *H. medicinalis* are spotted with black, and at every fifth annulus the spots are larger than on the intervening rings: the annuli thus marked are the second of their respective segments. Moreover, the same rings bear on the ventral surface minute paired apertures, the *nephridiopores* or excretory apertures (*np. 1, np. 1'*): of these there are altogether seventeen pairs, marking the first ring of the seventh and the second ring of the eighth to the twenty-third segments.

In front of the first and behind the last pair of nephridiopores one important external mark of segmentation fails, but a further indication is furnished by the presence on the middle ring of each undoubted metamere of a number of delicate transparent elevations, the *segmental papillæ* (*s.p.*), which have probably a sensory function. These structures are found along the whole length of the body, and as they mark the middle (third) ring of all those segments,

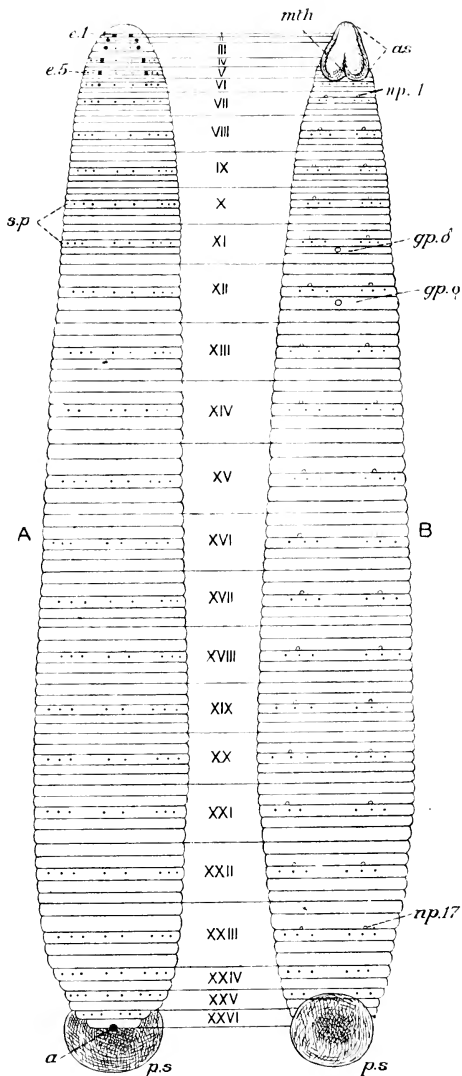

FIG. 411.—*Hirudo medicinalis*. *A*, dorsal; *B*, ventral aspect; *a. s.* anterior sucker; *e. 1*, first, and *e. 5*, fifth pair of eyes; *g. p. ♂*, male gonopore; *g. p. ♀*, female gonopore; *mth*, mouth; *np. 1*, first, and *np. 17*, seventeenth pair of nephridiopores; *p. s.* posterior sucker; *s. p.* segmental papillae; I—XXVI, segments.

the extent of which can be checked by the nephridiopores, it is legitimate to assume their segmental value in the anterior and posterior regions, where the controlling excretory apertures are absent. By the clue thus furnished it is found that there are six segments in front of that bearing the first pair of nephridiopores, and three behind that bearing the last pair, making a total of twenty-six metameres: of these the first seven and the last three have less than the normal number of rings.

The anterior sucker bears on its dorsal surface five pairs of small black spots, the *eyes* (*e. 1*, *e. 5*), the arrangement of which shows them to be special modifications of sensory papillæ, since they

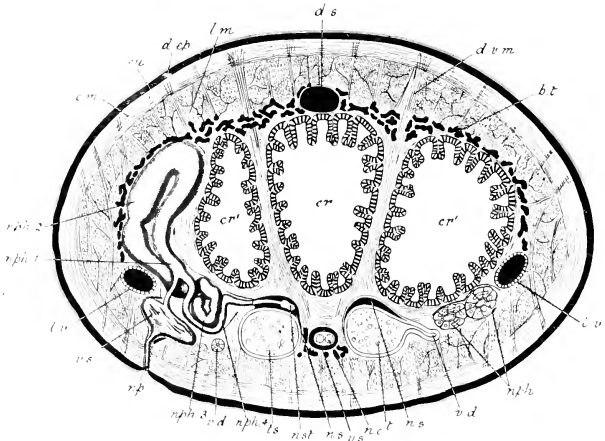

FIG. 412.—*Hirudo medicinalis*; transverse section. *b. t.* botryoidal tissue; *c. m.* circular muscles; *cr.* crop; *cr'*, diverticula of crop; *cu.* cuticle; *d. ep.* epidermis; *d. s.* dorsal sinus; *d. v. m.* dorso-ventral muscles; *l. m.* longitudinal muscles; *l. v.* lateral vessel; *n. c.* nerve cord; *nph. 1-4*, nephridium; *n. s.* nephrostomial sinus; *n. s. t.* ciliated funnel; *t. s.* testis; *v. d.* vas deferens; *v. s.* vesicle of nephridium; *r. s.* ventral sinus. (After Marshall and Hurst.)

occupy in the first five segments the precise position occupied in the sixth and following segments by segmental papillæ.

The perfectly definite and comparatively small number of metameres in the leech offers a striking point of contrast with what we have met with in the Chaetopoda, and is to be looked upon as a mark of higher differentiation.

Body-wall.—The body is covered externally by a thin cuticle (Fig. 412, *cu.*), which is constantly being cast off in patches and renewed. Beneath it is an epidermis (*d. ep.*) consisting of hammer-shaped cells, separated at their inner ends by spaces in which blood-capillaries run. The blood is thus brought into close relation

with the surrounding water, and the skin becomes a highly efficient respiratory organ. The space between the epidermis and the enteric canal is filled by a peculiar form of connective-tissue, consisting of a gelatinous matrix with interspersed cells and fibres, many of the former large and branched. More immediately surrounding the enteric canal is the peculiar and characteristic *botryoidal tissue* (*b. t.*) consisting of branched canals, the walls of which are formed of large cells loaded with black pigment. This system of canals is in communication on the one hand with the blood-vascular system and on the other with the greatly reduced cœlome.

Numerous unicellular glands are produced from the epidermis: the gland-cells themselves lie in the connective-tissue, and are continued into long ducts which open on the surface. Special glands in the ninth, tenth, and eleventh segments secrete the substance from which the cocoon is formed (*vide infra*, p. 503): the segments in question therefore constitute the *clitellum*.

The **muscular system** is well developed, and consists of an outer layer of circular (*c. m.*) and an inner of longitudinal (*l. m.*) fibres. There are also dorso-ventral fibres (*d. v. m.*) passing vertically between the pouches of the crop (*vide infra*), and radial fibres extending from the wall of the enteric canal to the integument: these take the place of the septa of Chætopods.

The **alimentary organs** are greatly modified in accordance with the blood-sucking habits of the animal. Surrounding the mouth are three *jaws*, one median and dorsal (Fig. 415, *d. j.*), the other two ventro-lateral (*v. l. j.*). Each (Fig. 413) has the form of a compressed muscular cushion, with a sharp, evenly curved, free edge covered with chitin, which is produced into numerous serrations or *teeth*: by means of its muscles each jaw can be moved backwards and forwards through a certain arc, and the three, acting together, produce the characteristic triradiate bite in the skin of the animal upon which the Leech preys.

The mouth leads into a muscular *pharynx* (Figs. 414 and 415, *ph.*) situated in the fourth to the eighth segments. Radiating muscles pass from its walls to the integument, and by their contraction dilate its cavity and suck in blood from the wounds made by the jaws. Around the pharynx are numerous unicellular *salivary glands*, which open close to the mouth: their secretion has the effect of preventing the coagulation of the blood taken as food.

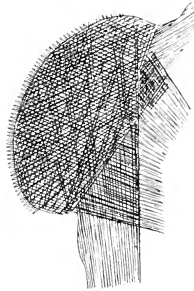

FIG. 413.—One of the jaws of *Hirudo medicinalis*. (After Leuckart.)

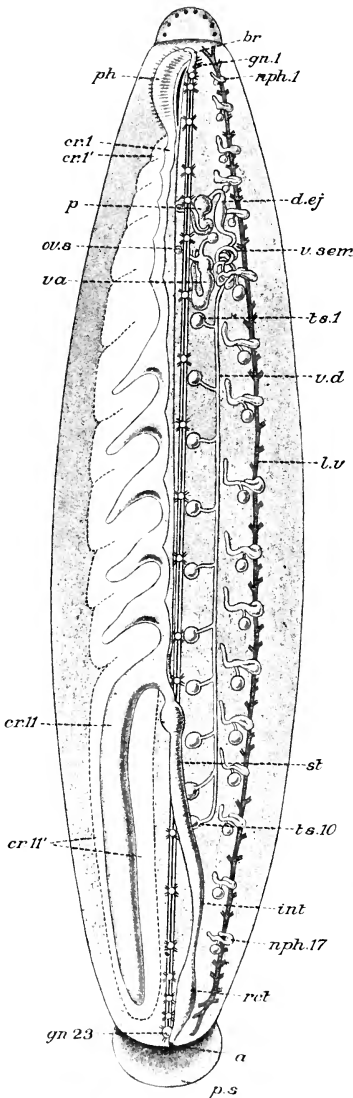

FIG. 414.—**Hirudo australis.** Dissection from the dorsal aspect; *a*, anus; *br*, brain; *cr. I*, first diverticulum of crop, contracted; *cr. II*, the same expanded; *cr. III*, the last diverticulum of the crop, contracted; *cr. IV*, the same expanded; *d*, *O*, ductus ejaculatorius; *gn. 1-23*, ganglia of ventral nerve-cord; *int*, intestine; *l*, *v*, lateral vessel; *nph. 1-17*, nephridia; *ov. s*, ovarian sac; *p*, penis; *ph*, pharynx; *p. s*, posterior sucker; *ret*, rectum; *st*, stomach; *ts. 1-10*, testes; *va*, vagina; *v. d*, vas deferens; *v. sem*, vesicula seminalis.

The pharynx communicates by a very small aperture with the second and largest division of the enteric canal, the huge *crop* (*cr.*), a thin-walled tube extending from the eighth to the eighteenth segment, and produced into eleven pairs of lateral pouches (*cr. I*, *cr. II*), the first ten of which are directed outwards and correspond each to a segment, while the eleventh (*cr. III*) passes directly backwards as far as the twenty-fourth segment. The lumen is divided between the pairs of pouches by transverse septa, perforated by central apertures, into eleven chambers. The crop is capable of great dilatation, and its form varies greatly according to whether it is empty or gorged with blood. Posteriorly the crop communicates by a minute aperture with the *stomach* (*st.*), a tubular chamber with a dilated anterior end, and having its wall produced internally into a spiral fold: this is the digestive portion of the canal; the blood is passed into it from the crop with extreme slowness, and undergoes an immediate change, its colour turn-

ing from red to green. The digestion of a whole cropful of blood takes many months. The stomach is continued into a narrow *intestine (int.)*: this passes into a somewhat dilated rectum (*rect.*) which turns slightly upwards and opens by the anus (*an.*) in the last annulus.

The **excretory system** consists of seventeen pairs of *nephridia (nph. 1-17)*, situated in segments 7-23. A typical nephridium (Fig. 416) has the general form of a loop passing upwards from the ventral body-wall, produced into an offshoot which extends inwards (mesially) to the corresponding testis, and connected posteriorly with a small bladder or *vesicle (vs.)*. The principal loop is divisible into two chief parts, the *main lobe (m. l.)* and the *apical lobe (a. l.)*, connected with one another by a short *recurrent lobe (r. l.)*: the offshoot to the testis is known as the *testis-lobe (t. l.)*; it is abbreviated in *H. australis*.

All these parts are formed of a close-set mass of gland-cells, traversed by a complex system of minute intra-cellular passages or *ductules*, which finally unite into a comparatively wide inter-cellular tube or *duct*: this winds through the main and apical lobes, and finally enters the vesicle, which opens posteriorly in the second annulus of the segment. The free end of the testis-lobe is swollen into a lobed mass (Fig. 412, *nst*) which lies in a sinus in connection with the testis. This lobed body is a modified ciliated

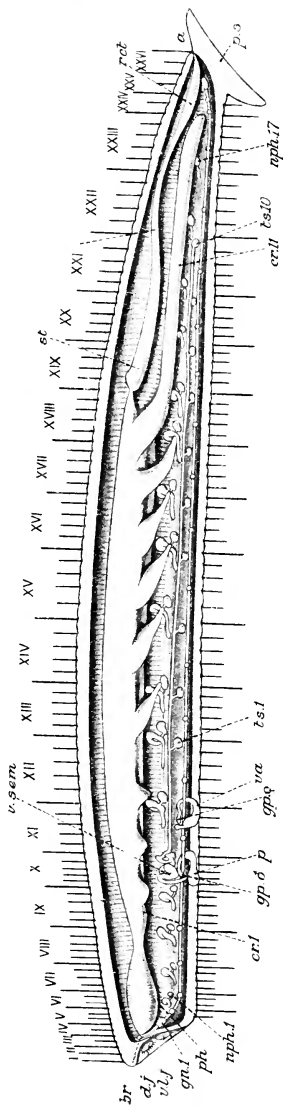

FIG. 415.—*Hirudo australis*.—Dissection from the left side, semi-diagrammatic; the longer vertical lines mark the metaneres, the shorter lines the annuli. Lettering as in Fig. 407, and in addition *d. j.*, dorsal jaw; *v. l. j.*, ventro-lateral jaw.

funnel: it has a great number of small ciliated openings into the sinus in which it lies. In most of the nephridia (all except the first six pairs) modified ciliated funnels are present attached to the inner ends of the nephridia, but these do not open into the canals of the latter.

There is a complex **blood-system** containing, like that of the Earthworm, red blood, the plasma coloured with hæmoglobin and containing sparsely distributed colourless corpuscles. But a striking difference from the preceding annulate types is found in the fact that the blood-containing spaces are of two kinds—*blood-vessels* proper, having muscular walls; and *blood-sinuses*, the walls of which are devoid of muscle.

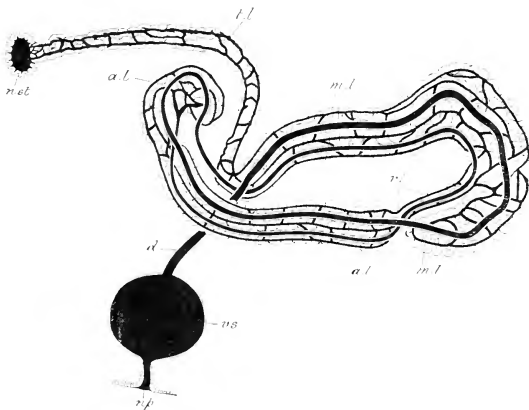

FIG. 416.—Nephridium of *Hirudo medicinalis*. *a. l.* apical lobe; *d.* vesicle-duct; *m. l.* middle lobe; *np.* nephridiopore; *nst.* ciliated funnel; *r. l.* recurrent lobe; *t. l.* testis-lobe; *vs.* vesicle. The communication here represented as existing between the ciliated funnel and the nephridial canals does not occur. (After Bourne.)

The two principal blood-vessels are lateral in position (Figs. 414 and 417, *l. v.*), running fore and aft at the level of the middle of the nephridia and uniting with one another at the anterior and posterior ends of the body. They send off branches both dorsally and ventrally, some of which anastomose with one another. The ultimate branches break up into capillaries in the integument, nephridia, &c.

The two principal sinuses are respectively dorsal (Figs. 412 and 417, *d. s.*) and ventral (*v. s.*), the former lying just above the enteric canal in the middle dorsal line, the latter occupying a similar position on the ventral side, and enclosing the ventral nerve-cord. The two sinuses are in connection with one another posteriorly, and are also in communication, by means of their

branches, with the capillaries of the skin. There is thus an indirect connection, by means of capillaries, between the blood-vessels and the sinuses, but no direct communication exists. The sinuses in which the ciliated funnels are lodged open into the ventral sinus. As we shall see more particularly in the general account of the class, the vessels and sinuses represent a greatly reduced coelome.

The **nervous system** is of the usual annulate type. There is a small *brain* (Figs. 414 and 415, *br.*) situated above the anterior end of the pharynx immediately behind the median dorsal jaw. It is connected by a very short pair of œsophageal connectives with the ventral nerve-cord, which consists of twenty-three well-marked rounded ganglia (*gn.* 1-23), situated in the third or middle ring of each segment, united by delicate double connectives

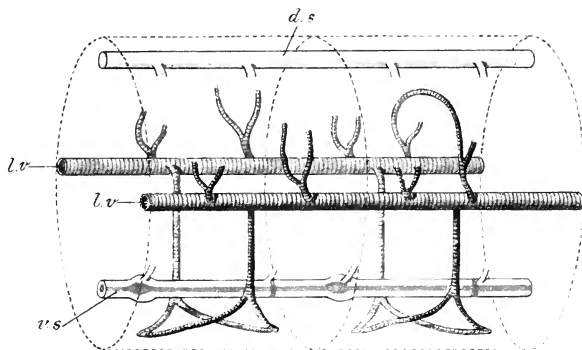

FIG. 417.—Diagram of principal blood-channels of **Leech**. *d. s.* dorsal sinus ; *l. v.* lateral vessel ; *v. s.* ventral sinus containing nerve-cord.

and a slender median strand. The ganglion-cells are regularly arranged in groups or packets. The first or sub-œsophageal ganglion is larger than the others, and is shown by development to be made up of five united pairs of embryonic ganglia : the last ganglion is also of unusual size, and results from the fusion of six pairs of ganglia distinct in the embryo. The whole ventral nerve-cord is contained in the ventral sinus. Nerves are given off from the ganglia, but not, as in the Earthworm, from the connectives, in which, also, nerve-cells are wholly absent.

The principal **sense-organs** are the *eyes*, of which there are five pairs (Figs. 411 and 418) situated round the margin of the anterior sucker, on the dorsal side, one pair in each of the first five segments. They occupy positions taken in the succeeding segments by segmental sense-organs, with which they are obviously homologous.

The structure of the eyes is peculiar: they are cylindrical in form (Fig. 418), the long axis of the cylinder being at right angles to the surface of the body. The outer layer is formed of black pigmented tissue (*pi.*), surrounding a layer of large, clear, refractive cells (*p.*),

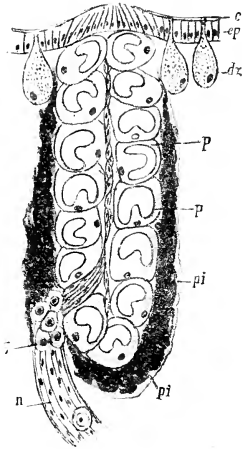

FIG. 418.—Section of eye of **Leech**.
c, cuticle; *dr*, gland-cells; *ep*, epidermis; *g*, nerve-cells; *n*, nerve; *p*, refractive cells; *pi*, pigment.
 (From Lang's *Comparative Anatomy*.)

which occupy the greater part of the organ. A nerve (*n.*) enters at one side, and is continued up the axis of the cylinder by a row of sensory cells. The margin of the anterior sucker also bears a large number of *goblet-shaped organs*, which are very probably organs of taste. The minute structure both of these and of the segmental sense-organs is very similar to that of the eyes. The function of the segmental sense-organs is unknown.

Reproductive Organs.—The Leech is monœcious. There are nine or ten pairs of *testes* (Figs. 414 and 415, *ts.*), in the form of small spherical sacs, situated in segments 12 to 20 or 21. Each gives off from its outer surface a narrow *efferent duct*, which opens into a common *vas deferens* (*v. d.*). In the tenth segment the vas deferens increases in width and forms a complex coil, the *vesicula seminalis* (*v. sem.*), from which is continued anteriorly a somewhat dilated muscular tube, the *ductus ejaculatorius* (*d. ej.*).

From each ejaculatory duct a narrow tube passes to the base of the *penis* (*p.*), a curved eversible muscular organ which opens on the ventral surface of the fourth annulus of the eleventh segment, in the middle line. The base of the penis is surrounded by a number of unicellular glands, which constitute the *prostate*, and secrete a substance by which the sperms are aggregated into masses called *spermatophores*.

The *ovaries* are coiled filamentous bodies, each enclosed in a small globular *ovarian sac* (*ov. s.*), situated in the eleventh segment. From each ovarian sac a short *oviduct* passes inwards and backwards, and unites with its fellow into a median duct, the walls of which are supplied with albumen-secreting gland-cells. The common oviduct opens into a curved muscular tube, the *vagina* (*va.*), which opens in the middle line on the ventral surface of the fourth annulus of the twelfth segment, *i.e.* one segment behind the male aperture.

It will be noticed that the ovaries of the Leech form a single pair, while the testes are multiple and segmental: also that, while

the gonads and efferent ducts of both sexes are paired, the penis and the vagina are median and unpaired. In the latter respect the contrast between the Leech and the Annulata previously discussed is very striking. Further important peculiarities are the enclosure of the ovary in a sac from which a duct leads directly to the exterior, and the fact that the testes are hollow sacs discharging the sperms into a cavity from which they pass directly to the efferent ducts. In Chaetopods, it will be remembered, the gonads lie freely in the cœlome, and their products—ova or sperms—are discharged from their external surfaces and carried off either by cœlomoducts or by “segmental organs.” It seems tolerably certain that in the Leech the cavities both of the ovarian sacs and of the testes represent shut-off portions of an almost obsolete cœlome, and that their ducts are cœlomoducts.

Development.—When breeding, two Leeches copulate, and one impregnates the other by passing spermatophores through its penis into the vagina. Simultaneous mutual impregnation has also been described. The clitellar segments (ninth to eleventh) secrete a cocoon (Fig. 419), into which spermatophores, ova, and a quantity of albumen, secreted by the gland-cells in the wall of the median oviduct, are passed. The animal then withdraws its head from the cocoon, the two ends of which close up by their own elasticity, producing a closed capsule in which embryonic development takes place. Segmentation is unequal, and results in the formation of a globular embryo, which, after hatching, swims about in the cocoon, actively devouring its albuminous contents, and finally escaping in a form closely resembling the adult.



FIG. 419.—The cocoon of *Hirudo*.
A, entire; B, in section. (After Leuckart.)

2. DISTINCTIVE CHARACTERS AND CLASSIFICATION.

The Hirudinea are Annulata in which the body consists of a limited and definite number of segments, and is marked externally by secondary rings or annuli, a variable number of which go to a segment. The anterior end of the body is suckorial, and several of the hindmost segments are fused to form a powerful sucking-disc, which is directed downwards and backwards. The mouth lies in the anterior sucker, the anus is usually dorsal and immediately in front of the posterior sucker. The cœlome is always more or less obliterated by connective-tissue, and is represented by sinuses of varying dimensions which contain blood. True blood-vessels, with muscular walls, are also present. The nervous system consists of a brain united by short cesophageal connectives to a ganglionated ventral nerve-cord. The excretory organs are

segmentally arranged nephridia. The sexes are united, the testes numerous and usually segmentally arranged, the ovaries a single pair. The testes have the form of sacs, and discharge their products internally: the ovaries either have a similar structure or are band-like and enclosed in ovarian sacs, into which the ova are set free. The penis and the vagina are unpaired, and open by median apertures, the male anterior to the female, on the ventral surface of the body. Development is usually direct, *i.e.* unaccompanied by a metamorphosis. Leeches are either free-living, or are permanently or intermittently parasitic: they inhabit either the land, fresh-water, or the sea.

The class is divided into the following two orders:—

ORDER 1.—RHYNCHOBDELLIDA.

Hirudinea in which the anterior part of the body can be protruded and retracted so as to form a proboscis or introvert.

This order includes *Clepsine* (*Glossiphonia*), parasitic on Snails, Frogs, &c.; *Piscicola*, on fresh-water Fishes; *Pontobdella* and *Branchellion*, on marine Fishes (Fig. 420).

ORDER 2.—ARHYNCHOBDELLIDA.

Hirudinea in which there is no proboscis.

Sub-order 1.—Gnathobdellida.

Arhynchobdellida in which the mouth is provided with two, or more usually three, toothed jaws.

This sub-order includes *Hirudo*, the common Leech, parasitic on Vertebrata; *Aulostoma*, the Horse-leech, free-living and carnivorous; *Hæmadipsa*, the Land-leech.

Sub-order 2.—Herpobdellida.

Arhynchobdellida in which the mouth is not armed with true jaws.

This group includes *Herpobdella* (*Nepheleis*) *Trocheta*, *Orobdella*, etc.—all fresh-water or terrestrial forms.

Systematic Position of the Example.

Hirudo belongs to the family *Hirudinidæ*, of the sub-order *Gnathobdellida*.

The presence of jaws places it in the sub-order *Gnathobdellida*: the possession of ten eyes, and the presence of five rings to all the segments except a few at the anterior and posterior ends, distinguish it as a member of the family *Hirudinidæ*: the genus *Hirudo* is distinguished by the constant presence of 26 segments and of 102 annuli.

3. GENERAL ORGANISATION.

In the essential features of their organisation the Leeches are a very uniform group: there are, however, a few interesting modifications of structure which must be referred to.

Form and Size.—Most kinds do not exceed a few centimetres in length, but the American species *Macrobdeella valdiviana* is said to attain a length of 76 cm. ($2\frac{1}{2}$ feet). The number of annuli to a segment varies from two to fourteen and is constant in each species, but the general form of the body is remarkably uniform, the external differences between various species depending largely on colour and on the development of papillæ, which in some cases are large and prominent. **Setæ** are absent in all except one genus, *Acanthobdeella*, which has two pairs on each side of the first five segments.

The **proboscis** (Fig. 421), the possession of which is distinctive of the Rhynchobdellida, is simply the retractile anterior end of the body, which, by the action of special muscles, can be drawn back into a temporary sheath. The organ is thus an *introvert*, like that of Sipunculoidea.

The chief differences in the structure of the **enteric canal** depend upon the varying number, or, in some cases, the total absence, of lateral pouches to the crop: for instance, the horse-leech has only a single pair, corresponding to the eleventh pair in *Hirudo*, while *Nepheleis* has none at all. In the Rhynchobdellida there is a distinct slender gullet (Fig. 421, *gul.*) leading from the pharynx to the crop (*cr.*), and thrown into a coil when the proboscis is retracted. Among the Gnathobdellida the median jaw is absent in some land-leeches, and in other species all three jaws are rudimentary or absent.

Blood-system and Cœlome.—In the medicinal leech, as we have seen, there are lateral vessels with contractile muscular walls and dorsal and ventral sinuses with non-contractile walls. All of these seem to be formed, in this and the rest of the Gnathobdellida, from cœlomic spaces, and none of them, therefore, correspond developmentally to the true blood-vessels of the Chætopoda, which are formed independently of the cœlome. In the rest, however, the dorsal and ventral vessels are developed in the manner of true blood-vessels, while the lateral vessels or sinuses are always cœlomic in origin.

In *Pontobdeella*, one of the Rhynchobdellida, there are dorsal and ventral as well as lateral vessels, and lateral as well as dorsal and ventral sinuses, and in each case the vessel is enclosed in the corresponding sinus. The ventral sinus also contains the nerve-cord and the ovaries, and offshoots of it surround the testes and the nephrostomes. In the Rhynchobdellids in general the cœlomic spaces remain fairly extensive, and are lined by a cœlomic epithelium.

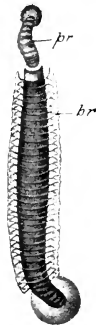
1. *Pontobdella*2. *Clepsine*3. *Branchellion*

Another interesting condition occurs in *Nepheleis*, in which the middle region of the body contains a series of paired, metamericly arranged spaces, surrounded by botryoidal tissue and containing the nephrostomes. Development shows that these cavities are derived

from true coelomic spaces in the embryo, formed, as in *Chaetopoda*, by a splitting of the mesoderm in each segment. *Acanthobdella*, already referred to as exceptional in the possession of setae, is also the only member of the class which has a well-developed and spacious coelome, divided by mesenteries into a number of segments.

In most instances the skin, with its abundant supply of

FIG. 420.—Three **Rhynchobdellida**. *br.* gills; *pr.* everted proboscis. (1, after Bourne; 2 and 3, after Cuvier.)

capillaries, constitutes the only respiratory organ, but in *Branchellion* (Fig. 420, 3), a Rhynchobdellid parasitic on the Electric Rays (*Torpedo* and *Hypnos*), and on one of the Australasian Skates (*Raja nasuta*), differentiated respiratory organs or gills (*br.*) are present in the form of delicate lateral outgrowths of the segments.

In most members of the class the nephridia are formed on the same general type as those of *Hirudo*, but differ in the structure of the ciliated funnels, which may be more or less modified, as in *Hirudo*. The funnels, where they occur, never open into the nephridial canals. Each funnel

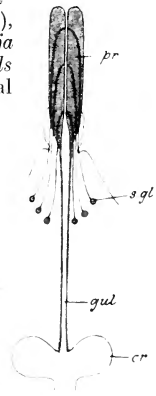
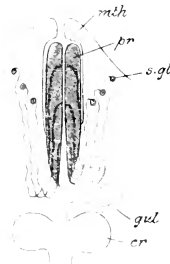

FIG. 421.—Proboscis of **Clepsine**. *A.*, retracted; *B.*, everted; *cr.* crop; *gul.* gullet; *mth.* mouth; *pr.* introvert; *s. gl.* salivary glands. (After Bourne.)

leads by a narrow ciliated duct into a *receptacle*, in which leucocytes laden with waste-matters are received from the coelomic spaces and sinuses, subsequently to undergo degeneration and absorption (Fig. 422). By its outer side this receptacle is in close relation to the inner end of the nephridium, and the waste-matters from the disintegrated leucocytes are no doubt received into the nephridial canals and thus passed out to the exterior. In *Hirudo* and *Herpobdella* (*Nephelis*) the receptacles appear to be the organs in which new blood-corpuses are manufactured. The ciliated funnels of the Hirudinea correspond more closely with the coelomoducts or ciliated organs of the Polychæta than with the nephrostomes; they are to be compared also with the "urns" of the Sipunculoidea. In the Rhynchobdellid *Pontobdella* a very interesting modification of the nephridial system occurs. Instead of distinct nephridia, there is found on the ventral surface of the body a very complex network (Fig. 423, *nph.*), which sends off on each side of each segment a short branch terminating in a ciliated funnel, and a similar branch which opens externally (*np.*). A similar modification occurs in Branchellion.

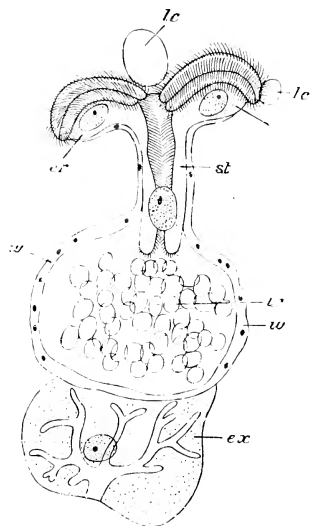

FIG. 422.—Ciliated funnel of *Herpobdella* (*Clepsine*). *cr.* crown-cells of funnel; *ex.* terminal cell of the nephridium; *lc.* leucocytes; *st.* duct leading to receptacle; *w.* wall of receptacle. (From Meisenheimer, after L. von Graff.)

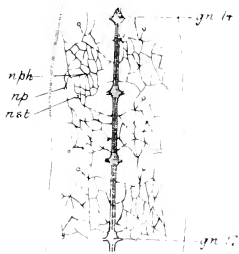

FIG. 423.—Nephridial system of *Pontobdella*. *gn.* 14, *gn.* 17, ganglia of nerve-cord; *np.* nephridiopore; *nph.* nephridial network; *nst.* ciliated funnel. (After Bourne.)

terminating in a ciliated funnel, and a similar branch which opens externally (*np.*). A similar modification occurs in Branchellion.

The **nervous system** always closely resembles that of *Hirudo*, as also do the **sense-organs**. The number of eyes is subject to considerable variation: they may be developed on the posterior sucker, or may be absent altogether.

Reproductive Organs.—The *testes* usually have the segmental arrangement found in *Hirudo*, their number varying from five to twelve

pairs. But in *Herpobdella* (*Nepheleis*) they are very numerous, and are not arranged segmentally. In the *Rhynchobdellida* the muscular penis is absent, its place being taken by an eversible sac. The form of the ovary with its containing sac in *Hirudo* is exceptional. As a rule, there is an elongated hollow ovary, producing ova from its epithelial lining, and thus agreeing very closely in structure with the testis.

In *Clepsine*, a fresh-water *Rhynchobdellid*, copulation in the ordinary sense of the word has never been observed, but one individual has been seen to deposit one or more spermatophores on any part of the body of another—often on the back. The spermatophore, which is nearly $3\frac{1}{2}$ mm. long, apparently exerts a solvent action on the skin, since, after a short interval, the spermatic substance streams through the skin into the cœlomic spaces, probably making its way at last to the ovaries. This extraordinary

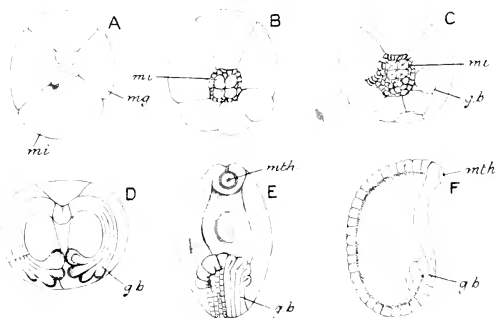

FIG. 424.—Six stages in the development of *Clepsine*. *g. b.* germinal bands; *mg.* megameres; *mi.* micromeres; *nth.* mouth. (After Whitman.)

process of *hypodermic impregnation* probably takes place in other genera, but has been most closely followed in *Clepsine*.

It is in *Clepsine* that the early stages of **development** are best known. Segmentation is unequal, the embryo consisting, in the eight-celled stage (Fig. 424, A), of four large ventrally placed megameres (*mg.*) and four dorsal micromeres (*mi.*). One of the megameres, posterior in position, divides into two cells (B): the so-called *neuronephroblast* and *mesoblast*, the latter of which at once divides into two. As shown by their subsequent history, the neuronephroblast and the mesoblast correspond respectively to the first and second somatoblasts of *Nereis*. The former divides and subdivides to form two symmetrical groups of four cells each, situated at the posterior pole. The number of micromeres increases, at first apparently by division of the megameres. The latter subsequently give off a number of small endoderm cells.

The embryo now consists of the three large megameres with a number of endoderm cells, a cap of small micromeres forming an ectodermal layer which is extending over the surface, with, at the posterior pole, two symmetrical groups of neuronephroblast cells (four in each), and, somewhat deeper, the two mesoblast cells. From each of the ten cells last mentioned new cells are given off in front in such a way as to form ten rows of cells, five on each side, four being derived from neuronephroblasts and one from the mesoblast cell. These two sets of rows of cells constitute the so-called *germinal bands* (*g. b.*). From their subsequent fate it is clear that they correspond to the mesoderm bands of *Nereis* plus the neural plate. They grow forwards, the ectoderm extending with them, over the endoderm and megameres. At first they diverge widely, but their anterior ends subsequently meet towards the anterior end of the embryo. Later the intermediate parts of the bands, originally widely separated from one another owing to their divergence during growth, approach one another and meet along the middle line of the ventral surface. The germinal bands give rise to the nerve-cord, the mesodermal segments, and the nephridia. The layer of micromeres not only gives rise to the whole ectoderm but also forms the head—the germinal bands not extending into that region. The embryonic enteric cavity (mesenteron) becomes formed by arrangement of the endoderm cells round the three megameres, which break up to form nutrient material or yolk destined to become absorbed in nourishing the embryo. The pharynx is formed by an invagination of the ectoderm which joins the mesenteron. At this stage the embryo leaves the egg, and soon escapes from the cocoon to pass through its later stages attached to the ventral surface of the parent.

In the Gnathobdellida the young are hatched at an early stage of development, and their megameres contain but little yolk: they are nourished up to the time of leaving the cocoon on the albumen with which the latter is filled. One member of this order, *Herpobdella* (*Nepheleis*), is remarkable for undergoing a metamorphosis: the anterior end of the embryo is ciliated, and it possesses a provisional pharynx and several pairs of provisional nephridia. Paired masses of cells, the *head-germs*, are developed in the head, and from these and the germinal bands the whole body of the adult is produced, the greater part of the larval body being cast off. This process closely resembles the development of the pilidium larva of certain Nemerteans (p. 290).

Habits, Distribution, &c.—The majority of the Hirudinea are inhabitants of fresh-water, and live, like the Medicinal Leech, by sucking the blood of higher animals—Vertebrates or Molluscs. It is doubtless in correlation with this intermittent parasitism—the chance of finding a vertebrate host being an infrequent one—that the crop has attained such vast dimensions, holding, in the case of

the medicinal leech, as much blood as takes it a year to digest. The allied species *Hirudo sanguisuga* has been found in the nasal passages of man, producing serious results, and being, to all intents and purposes, an internal parasite. The same is the case with the horse-leech, *Hæmopsis vorax*, taken in, when young, by horses and cattle while drinking. It attaches itself to the pharynx and may even descend the trachea. Others are permanent ecto-parasites: for instance, *Branchellion* occurs on the outer surface of the Skate, Electric Ray, and other Fishes, entire families of this leech, including individuals of all sizes, being sometimes found crowded together on a small area of skin, which is distinctly marked by their powerful posterior suckers. Other fish-parasites are *Pontobdella*, on Rays, and *Piscicola*, on fresh-water Fish. *Aulostoma*, to which, as well as to *Hæmopsis*, the name Horse-leech is applied, is carnivorous, feeding on snails and other Molluscs; so also are *Glossiphonia* (*Clepsine*), *Herpobdella* (*Nephelis*), and the gigantic *Macrobdella*. The last-named genus and some others are of subterranean habits, living in moist earth. The Land-leeches (*Hæmadipsa*) live in the forests of many parts of the world, and in spite of their small size, which does not exceed 30 mm. in length and 5 mm. in diameter, are much dreaded for the persistent attacks they make on men and cattle.

Many genera are very widely distributed: for instance, the Land-leeches (*Hæmadipsa*) occur in India, Ceylon, the East Indies, Japan, Australia, and South America, a distribution which seems to indicate that the group is one of great antiquity.

GENERAL REMARKS ON THE ANNULATA.

A special feature of the Annulata, as distinguished from the phyla previously dealt with, is *metameric segmentation*. In some of the Platyhelminthes, as we have seen, and in *Gordius* to a less extent, there obtains a condition to which the term pseudo-metamerism is applied. In such cases there is a serial repetition of certain of the organs—gonads, diverticula of the intestine, nerve-commissures, &c.—in such a way as to produce a jointed appearance, though the body is not divided into definite segments. An appearance resembling segmentation is produced also in certain Rhabdocœles that multiply by budding, chains of zooids remaining connected together for a time. In the strobila of the Cestodes we recognise a condition which might be described as combining pseudo-metamerism with the formation of a chain of zooids. The condition of true metamerism, as we observe it in the Annulata, is capable of being deduced from a condition of pseudo-metamerism as it occurs in *Gunda* (p. 251), the pseudo-metameres becoming converted into true metameres by the development of inter-segmental constrictions and the completion of internal partitions. If we suppose that

during this process serially repeated outgrowths of the enteron became separated off to form series of coelomic sacs enclosing the gonads, a condition would be reached not far removed from that which characterises the Annulata. On the other hand, the metameric condition is deducible from the condition of a linear colony of zooids proliferating at the posterior end, the zooids, though becoming each complete in itself, not, under ordinary circumstances, becoming detached. The establishment of a closer connection between the corresponding organs of the zooids in such a colony, with the special differentiation of the anterior end, would result in a condition closely resembling the metamerism of the Annulata. It is conceivable that a condition of pseudo-metamerism was followed by that of a linear series, not of zooids, but of comparatively independent parts capable of readily reproducing the animal when detached, and that a secondary closer connection established

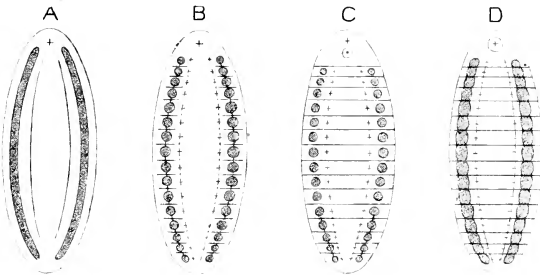

FIG. 425.—Diagram to illustrate possible relations of the unsegmented to the metamerically segmented worm. *A*, unsegmented worm with differentiated head end; *B*, pseudo-metamerism; *C*, linear series of zooids in which the first zooid differs in character from the others and in which the formation of new zooids takes place at the posterior end; *D*, metamerically segmented worm.

between the organs of all the series of parts resulted in the metameric condition.

It has to be borne in mind, however, in estimating the breadth of the gap between the Annulata and the Platyhelminth that the former differs from the latter not only in the presence of metameric segmentation, but also in the possession of a totally distinct type of nervous system. In this respect, in fact, *Gordius* (Nemathelminthes) is apparently nearer the Annulata than are any of the Flat-worms.

Metamerism is not universal in the phylum. In some (Archi-Annelida) it may be said to be incipient or rudimentary; in others (Echiurida and Sipunculoidea) vanishing or vestigial. The Archi-Annelida are in this, as in some other respects, the most primitive of the Annulata, and through them it seems possible to connect the higher members of the phylum with such lower forms as *Dinophilus*

(p. 330) and the *Histriobdellea* (p. 331). The general occurrence of the trochophore larva may be taken as pointing to descent from an unsegmented ancestor having resemblances to the trochophore, and a form like *Dinophilus* would afford us an intermediate link between such a hypothetical ancestor and *Polygordius* or *Protodrilus*.

The position of the Sipunculoidea in the Annulata is, as already noticed, a matter of doubt; if we dissociate them from the Echiurida there is little to connect them positively with the other members of the phylum. But, on the whole perhaps, the evidence in favour of regarding them as allied to the Echiurida, and through them with the Chætopoda, is sufficiently strong. The segmentation has become more completely aborted in the Sipunculoidea, and apparently, in further adaptation to a sedentary life in fissures and burrows, the anus has been displaced forwards as in several groups of animals that are permanently fixed.

Affinities between the Phoronida (p. 348) and the Sipunculoidea have often been supposed to exist, and by some zoologists it has been proposed to unite the two groups in one class. It seems probable, however, that the very manifest resemblances which undoubtedly exist do not indicate a near relationship, but are the result of converging modifications of originally widely different stocks. The most striking of these points of resemblance are two—(1) the approximation of the anus towards the oral aperture, and (2) the presence of the tentacular circlet. But a study of the development shows that these common features arise in totally different ways in the two cases. The forward position of the anus in the Sipunculida is brought about by a gradual displacement resulting from the growth of the aboral region of the body; and the invagination and evagination by which the corresponding result is attained in Phoronis do not occur. Again, while in Phoronis the tentacles of the adult may be looked upon as formed by the development of processes along the line occupied by the post-oral circlet of cilia, in the Sipunculida the tentacular lobes have nothing to do with the post-oral circlet, but are formed by the growth of a series of lobes from the margin of the mouth itself. The larva of the Sipunculida again is, as already pointed out, very nearly related to the larva of the Chætopoda, and is a typical trochophore; while the Actinotrocha larva of Phoronis diverges somewhat widely from that type.

In adult structure, particularly in the absence of parapodia and setæ and the reduction of the cœlome, the Hirudinea differ markedly from the Chætopoda; but a study of their earlier developmental stages shows unmistakably their close connection with the latter group, more particularly with the Oligochæta; and the existence of an undoubted Leech (*Acanthobdella*) with setæ and with a well-developed cœlome traversed by mesenteries helps still further to bridge over the gap between the two classes.

The following diagram will serve to illustrate this view of the relationships of the various groups referred to:—

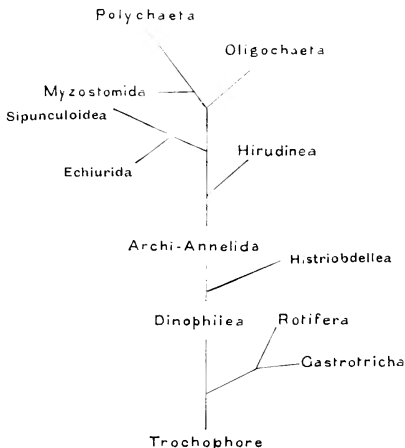

FIG. 426.—Diagram illustrating the relationships of the Annulata and the Trochelminthes.

It should be added, however, that it is not likely that the trochophore actually represents the ancestral form, since, to some extent at least, its special features, such as the special arrangement of the cilia, may be adaptations to a pelagic mode of life.

SECTION XI

PHYLUM ARTHROPODA

IN this large and important group of animals we meet with a characteristic feature of the Chætopoda, viz. metameric segmentation, and also with more or less perfect bilateral symmetry; the mouth and anus are at opposite ends of the elongated body, and the central nervous system consists of a dorsal brain and a double ventral chain of ganglia. There is, however, an important advance on the segmented Worms in the circumstance that each typical segment bears a pair of appendages, distinguished from the simple foot-stumps or parapodia of the Polychæta in being divisible into distinct limb-segments or *podomeres*, separated from one another by movable joints and acted upon by special muscles. Arthropods are also characterised by the almost universal absence of cilia, by their muscles being nearly always of the striped kind, and by the body-cavity largely corresponding not to a true cœlome, but to a *hæmocœle*, in free communication with the circulatory system and developed from the latter.

The following are the most important subdivisions of the phylum:—

Class 1. CRUSTACEA, including Crayfishes, Crabs, Shrimps, Wood-lice, Barnacles, Water-fleas, &c.

Class 2. ONYCHOPHORA, including only the curious caterpillar-like *Peripatus*, and a small number of closely related genera.

Class 3. MYRIAPODA, including the Centipedes and Millipedes.

Class 4. INSECTA, including the true or six-legged Insects, such as Cockroaches, Locusts, Flies, Beetles, Butterflies, and Bees.

Class 5. ARACHNIDA, including Spiders, Scorpions, Mites, &c.

CLASS I.—CRUSTACEA.

1. EXAMPLES OF THE CLASS.

a. Apus or Lepidurus.

Apus and *Lepidurus* are two closely allied Crustaceans found in the fresh-waters of most parts of the world, but curiously local in distribution and by no means common. They are so much

alike that, save in minor details, the same description will apply to any species of either genus.

External Characters.—The animal (Fig. 427) is from 20 to 30 mm. in length, and has the anterior two-thirds of the dorsal surface covered by a thin chitinous shell or *carapace*, beyond the posterior edge of which the hinder part of the body (*abd.*) projects as a nearly cylindrical structure distinctly divided into segments.

The last or *anal segment* bears a pair of long processes, the *caudal styles* (*a. f.*), between which, in *Lepidurus*, is a flat scale-like *post-anal plate* (Fig. 428). On the dorsal surface of the carapace, near its anterior border, are the *paired eyes* (*E*), closely approximated in front, diverging posteriorly. Immediately in front of them is a small black *median eye* (*e.*), and between their diverging posterior ends a semi-transparent oval area, the *dorsal organ* (*d. o.*). Passing transversely across the carapace, a short distance behind the dorsal organ, is a shallow furrow, the *cervical fold*, immediately posterior to which a pair of coiled tubes (*sh. gl.*) are seen, one on each side of the carapace: these are the *shell-glands* or excretory organs.

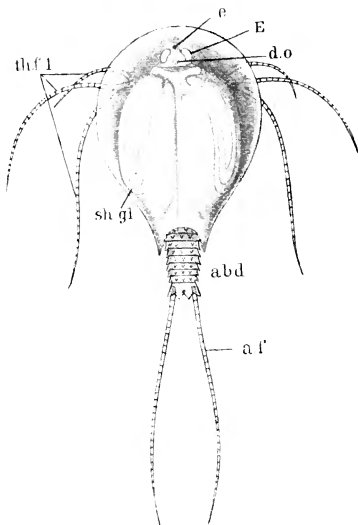

FIG. 427.—*Apus cancriformis*, dorsal aspect. *abd.* abdomen; *a. f.* caudal styles; *d. o.* dorsal organ; *E*, paired eye; *e.* median eye; *sh. gl.* shell-gland; *th. f. 1*, endites of first thoracic foot. (From Bronn's *Thierreich*.)

The carapace is attached only as far back as the cervical fold: behind that level it is free, and, when lifted up or cut away (Fig. 428), shows the greater part of the body of the animal, divided into segments like the posterior portion. From the cervical groove backwards about twenty-eight or thirty segments can be counted: the region in front of the cervical groove shows no sign of segmentation, and is distinguished as the *head*. The segments have the form of chitinous rings, often produced into small spines: each ring slightly overlaps its successor, and is connected with it by a narrow

area, the *articular membrane*, the chitination of which is less pronounced than that of the rings themselves. By this arrangement

the segments are freely movable upon one another in all directions, the articular membranes acting as joints. The last or anal segment is pierced by the terminal *anus* (Fig. 431, *an.*).

The ventral surface of the head is formed by a flattened *sub-frontal plate* (Fig. 429, *s.f.pl.*), continuous marginally with the carapace. The posterior edge of this plate is convex backwards, and is produced in the middle line into a shield-shaped process, the *labrum* or upper lip (*lbr.*), which overhangs the *mouth*. From the sub-frontal plate also arise, on each side, two delicate processes, the innermost called the *antennule* (*ant. 1*), the outermost

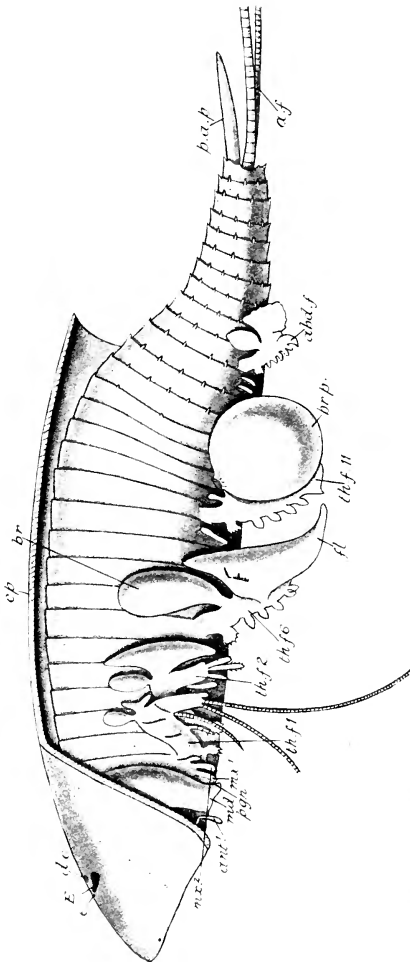

FIG. 428.—*Lepidurus kirkii*, side view, with half of carapace and most of the appendages removed. *a.f.*, caudal styles; *abd.f.*, abdominal foot; *ant. 1*, antennule; *br.*, bract; *br. p.*, brood-pouch; *cp.*, carapace; *d. o.*, dorsal organ; *E.*, paired eye; *e.*, median eye; *f.*, flabellum; *md.*, mandible; *m.x. 1*, *m.x. 2*, maxillae; *p.a.p.*, post-anal plate; *ppn.*, paragnatha; *th.f. 1*—*th.f. 12*, thoracic feet.

antenna (*ant. 2*): these are the first two pairs of *appendages*. The

third pair consists of two strong toothed bodies of a deep brown colour, placed one on each side of the mouth, and called the *mandibles* (*md.*). The remaining appendages form two rows of delicate leaf-like processes, attached to the segmented portions of the body, and overlapping one another from before backwards: their number varies from forty to nearly seventy (*th. f.*, *abd. f.*).

Appendages.—The *antennule* (Fig. 430, 1) consists of a bent rod bearing delicate chitinous bristles or *setæ* at its tip, and presenting, at the bend, a joint, due to the presence of an articular membrane. The appendage is thus made up of two *podomeres* or limb-segments, movably articulated together. Its function is probably tactile.

The *antenna* (2) is absent in some species both of *Apus* and *Lepidurus*: in *A. cancriformis* it is a very delicate hook-shaped unjointed structure, probably functionless. As we shall see from the study of development, it is a vestigial organ.

The *mandible* (3) is also an unjointed appendage. It has the form of a deeply concavo-convex plate, strongly chitinised, and produced along its inner edge into strong teeth. The mandibles lie one on each side of the mouth, and are so articulated that, by means of muscles, their toothed edges can be brought together in the middle line, so as to rend the food.

The fourth and fifth appendages are very small, and are probably functionless or nearly so: they follow one another just behind the mandible, and are called the *first* and *second maxillæ*. The first maxilla (4) consists of two curved chitinous plates, the second of a basal portion produced into two branches (5). Between the first maxilla and the mandibles are a pair of delicate unjointed processes, the *paragnatha* (Fig. 428, *pgn.*): they form together a sort of lower lip, and are not usually reckoned as appendages.

The foregoing appendages all spring from the unsegmented anterior portion of the body or head. As we shall see, however, the succeeding limbs arise each pair from its own segment, so that the presence of five pairs of appendages on the head may

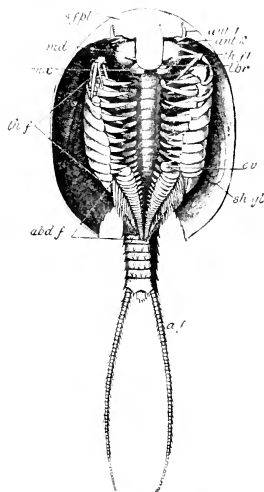

FIG. 429.—*Apus glacialis*, ventral aspect. *abd. f.* abdominal feet; *ant. 1.* antennule; *ant. 2.* antenna; *lbr.* labrum; *md.* mandible; *mx.* first maxilla; *ov.* aperture of oviduct; *s. f. pl.* sub-frontal plate; *sh. gl.* shell-gland; *th. f.* thoracic feet; *th. f. 1.* first thoracic foot. (After Bernard.)

be taken provisionally as an indication that this region of the body is composed of five fused segments.

The sixth appendage (6) springs from the ventro-lateral region of the first clearly marked segment, and is the first of the long row of appendages plainly visible in a ventral view. It consists of an *axis* formed of four podomeres (1-4), and bearing a number of offshoots: six of these, called *endites* (*en. 1—en. 6*), arise from its inner or mesial border; two, called *exites* (*br., fl.*), from its outer or lateral border. The proximal endite (*en. 1*) is small, and bears strong spines; in connection with its fellow of the opposite side it is used to seize food-particles and pass them on to the mouth: it is therefore conveniently distinguished as the *gnathobase*. The

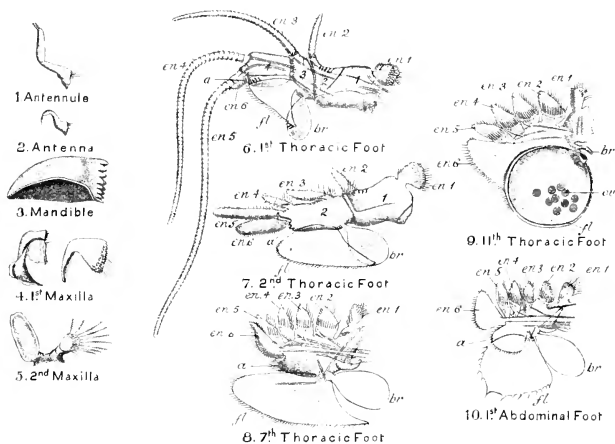

FIG. 430.—Typical appendages of *Apus*. 1-4, podomeres of axis; *br.* bract; *en. 1—en. 6*; endites; *fl.* flabellum; *ov.* ova. (After Lankester.)

distal endite is rudimentary (*en. 6*): the remaining four (*en. 2-5*) are long, jointed filaments. The proximal exite is nearly triangular, and is called the *flabellum* (*fl.*); the distal exite is oval, and is known as the *bract* (*br.*); both probably serve a respiratory function.

The seventh appendage (7) has only two podomeres in the axis, and the endites are comparatively short and flat. The next eight, *i.e.* those borne on the third to the tenth free segments, closely resemble one another: each (8) has an unjointed axis and short leaf-like endites, the whole appendage having a distinctly foliaceous character. The sixteenth appendage—that of the eleventh free segment—resembles its predecessors in the male, but in the

female (9) is peculiarly modified. The distal portion of the axis forms a hemispherical cup, over which the flabellum (*fl.*) fits like a lid: in this way a capsule or *brood-pouch* is produced, which serves for the reception of the eggs, and the appendage is distinguished as the *oostegopod* or brood-foot. The brood-feet and the adjacent genital apertures allow of a very convenient division of the body: all that region from the first free or postcephalic segment to that bearing the oostegopods, both inclusive, is called the *thorax*, and its appendages the *thoracic feet*: it consists of eleven metameres. The remaining segments, from the twelfth to the last inclusive, constitute the *abdomen*, and their appendages are called the *abdominal feet*.

The abdominal resemble the thoracic feet in general characters, having the same foliaceous form (10), with unjointed axis, small leaf-like endites, and large flabellum and bract. They gradually diminish in size from before backwards; and, from the third abdominal segment onwards, two or more pairs of appendages spring from each segment, so that while the total number of abdominal segments, in *A. cancriformis*, is twenty-two, and the five hindermost of these are without appendages, there are altogether fifty-two pairs of abdominal feet. It seems probable that segments bearing more than one pair of appendages represent two or more fused—or, perhaps one should rather say, imperfectly differentiated—metameres.

Body-wall.—The whole body is, as already mentioned, covered by a layer of chitin of varying thickness, which constitutes an *exoskeleton* or external supporting structure. Immediately underlying it is the deric epithelium or epidermis, from which the chitin is secreted layer by layer. Thus the exoskeleton of *Apus* is a continuous cuticular structure, exhibiting segmentation in virtue of the fact that, while comparatively thick and strong in places where no movement is required, it is thin and flexible in the intervening spaces, and thus allows of the movement of the harder parts upon one another.

The setæ, which occur on many parts of the body, and in particular fringe the appendages, are hollow offshoots of the chitinous cuticle, containing a protoplasmic core continuous with the epidermis. They thus differ fundamentally from the setæ of *Chætopods*, which are solid rods sunk in muscular sacs.

The **muscular system** is well developed (Fig. 431). Underlying the epidermis is a layer of connective-tissue, and beneath this is found, in the posterior or limbless part of the abdomen, a layer of longitudinal muscles encircling the body and attached by connective-tissue to each segment. In this way the muscular layer is itself segmented, being divided by the connective-tissue insertions into muscle-segments or *myomeres*. The action of these muscles is to approximate adjacent segments: according as the fibres on the

dorsal, ventral, or lateral regions contract, the abdomen will be raised, lowered, or turned sideways.

In the limb-bearing portion of the abdomen and in the thorax there is no longer a continuous muscular tube, but paired dorsal (*d.m.*) and ventral bands, which pass respectively above and below the origins of the limbs: the dorsal bands arise in front from the head-region, the ventral from a strong fibrous plate, the *cephalic apodeme* (*c. ap.*), lying just behind the gullet.

Each appendage is moved as a whole by muscles passing into it from the trunk: its various parts are acted upon by delicate muscular slips running to the various podomeres of the axis and to the endites, thus rendering them separately movable. The only example we have yet met with of appendages moved by definite muscular bands is that of the curious Rotifer *Pedalion* (p. 323). The muscles are all striped, a character which applies to the Arthropoda generally, with the exception of the Onychophora.

Digestive Organs.—

The *mouth* (Fig. 431, *mth.*) is situated on the ventral surface of the head, and is bounded in front by the labrum (*lbr.*), on each side by the mandibles, and behind by the paragnatha. The food appears to be pushed forwards towards the mouth by the toothed

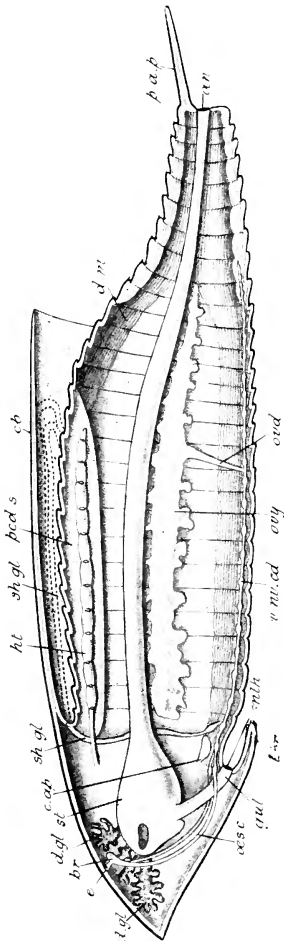

FIG. 431.—*Lepidurus kirckii*, sagittal section (semi-diagrammatic). *an.*, anus; *br.*, brain; *c. ap.*, cephalic apodeme; *cb.*, curapace; *d. gl.*, digestive gland; *d. m.*, dorsal muscles; *e.*, median eye; *gut.*, gullet; *ht.*, heart; *lbr.*, labrum; *mth.*, mouth; *ov.*, ovary; *pericardial sinus*; *ped. s.*, pedal sinus; *sh. gl.*, shell-gland; *st.*, stomach; *v. m.*, ventral muscle; *v. m.*, ventral nerve-cord.

bases of the thoracic feet, and is broken up by the mandibles, which work laterally. The maxillæ are probably functionless, or nearly so.

The mouth leads into a narrow *gullet* (*gul.*), which passes upwards and forwards into the head and enters a wide *stomach* (*st.*), from which a straight *intestine* (*int.*) is continued back to the terminal anus (*an.*) From each side of the stomach is given off a wide tube (*d.gl.*) which branches extensively, its ramifications finally ending in delicate *cæca*. The larger branches of these *digestive glands* contain food in process of digestion: their ultimate *cæca* secrete a digestive juice: the walls of the stomach itself are non-glandular. The walls of the enteric canal consist of an inner layer of epithelium and an outer layer of connective-tissue and muscle. In the gullet and in the posterior end of the intestine the epithelium secretes a thin cuticle, which thus comes to form the actual lining of the cavity. It is shown by development that the portion of the canal devoid of a chitinous lining is formed from the archenteron of the embryo: the gullet is developed from the stomodæum, the posterior end of the intestine from the proctodæum.

The **body-cavity** is divided into several parts by membranous partitions (Fig. 432): there is a large median cavity in which the enteric canal (*i*) lies, called the *intestinal sinus*: on each side of this are *lateral sinuses*

containing the muscles; and in the dorsal region is a median cavity, the *pericardial sinus*. All these spaces are devoid of an epithelial lining, and contain blood: as will become evident later, they do not correspond with the *cœlome* of the higher worms.

The central organ of the **circulatory system** is the *heart* (Fig. 431, *ht*, and Fig. 432, *h*), a narrow tube contained in the pericardial sinus. It is pierced laterally by several pairs of apertures or *ostia* provided with valves opening inwards, and is continued in front into a narrow tube, the *cephalic artery* (*e. art.*), which extends into the head and gives off near its origin a pair of arteries to the shell-glands (Fig. 429). When the heart contracts, the blood is driven through these arteries to the head and carapace: it then travels backwards in the intestinal sinus, passes to the limbs, and is returned to the pericardial sinus, finally re-entering the heart,

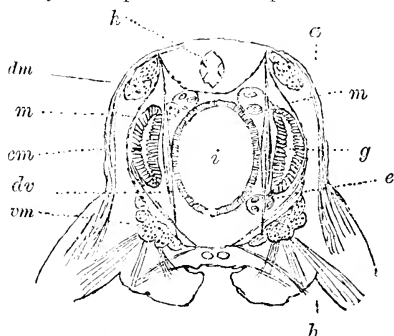

FIG. 432.—Transverse section of *Apus*. *cm*, muscles to feet; *dv*, dorso-ventral muscles; *e*, eggs; *dm*, dorsal muscles; *g*, ovary; *h*, heart; *i*, intestine; *m*, partition between intestinal and lateral sinus; *vm*, ventral muscles. (From Bernard.)

during its diastole, through the ostia. The plasma of the blood is coloured red by hæmoglobin, and contains amœboid corpuscles.

As already mentioned, the function of **respiration** is discharged by the flabella and bracts of the feet, which are abundantly supplied with blood and the movements of which ensure a constant renewal of the water in their neighbourhood. The **renal organ** or *shell-gland* (Fig. 433) consists of a coiled *urinary tube* (*uc.*) lying between the two layers of the carapace and lined by gland-cells. At one end the tube is connected with an *end-sac* (*ts.*), also lined with glandular epithelium; at the other it dilates into a small *bladder* (*b.*) which opens on the second maxilla (*m.*).

The **nervous system** (Fig. 434) is constructed on the annulate type. There is a squarish *brain* (*br.*) situated in the dorsal region

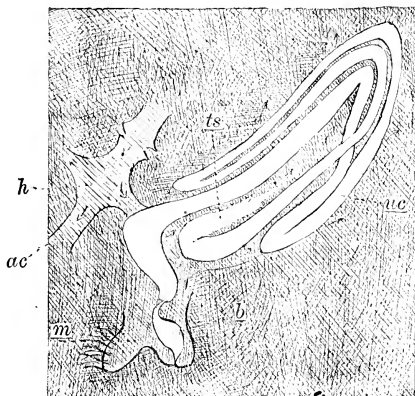

FIG. 433.—Shell-gland of *Apus*, diagrammatic. *ac.* cephalic artery; *b.* bladder; *h.* heart; *m.* second maxilla; *t.s.* end-sac; *uc.* urinary tube. (From Bernard.)

of the head, beneath the eyes. From it a pair of *œsophageal connectives* pass backwards and downwards to join the *ventral nerve-cord*, which consists of a double chain of ganglia (*gn. 1-4*) united by longitudinal connectives and transverse commissures so as to have a ladder-like appearance. The first pair of ganglia lies immediately behind the mouth, and sends off *visceral nerves* which join to form a ring round the gullet, swollen in front into a small *visceral ganglion*

(*v. gn.*). Passing backwards the nerve-chain diminishes in size, and comes to an end at about the level of the last pair of abdominal feet (Fig. 431). The origin of the nerves given off from the central nervous system presents many points of interest. From the fourth ganglion of the ventral cord backwards each pair of appendages has its own pair of ganglia, the metameric correspondence between the limbs and the nervous system being complete. The mandibles and the first maxillæ also receive nerves, each from their own pair of ganglia, their serial homology with the more typical appendages being thus confirmed. But the second maxillæ receive their nerves (*mx. 2*) from the connectives between the third and fourth ganglia :

the ganglion belonging to their segment may be assumed to have atrophied. The antenna is supplied by a nerve (*ant. 2*) which springs from the œsophageal connective, but which can be traced backwards to the first ganglion of the ventral chain: this fact may be taken as an indication that the antennæ are serially homologous with the jaws and feet—that they are, in fact, metameric or post-oral appendages which have shifted forwards, one on each side of the mouth, thus becoming pre-oral. The nerve of the antennule (*ant. 1*) also springs from the œsophageal connective, but is traceable forwards to the brain, where it is connected with a special group of nerve-cells. This has been explained by supposing that the antennule is a post-oral appendage the ganglion of which has moved forwards along the œsophageal connective and fused with the brain—a process which actually takes place with the ganglia of the antennæ in the higher Crustacea. But it is also possible to consider the antennules as pre-oral appendages, belonging, like the prostomial tentacles of Chætopods, to the prostomial region, and therefore receiving their nerves from the brain or prostomial ganglion. The median and paired eyes are also supplied by nerves from the brain.

Organs of Sense.—The setæ which occur on so many parts of the body, and especially as fringes to the limbs, are to be considered as *organs of touch*: the only other organs of special sense are the eyes. The *paired eyes* are, as we have seen, situated on the dorsal surface of the head, just over the brain: they are covered by transparent cuticle forming the *cornea*, beneath which is a narrow space or *water-sac*, communicating with the exterior by a pore, and therefore filled with water. The eye itself is made up of a large number of radially arranged elements called *ommatidia* (Fig. 435), each of which consists of an outer and an inner portion. The outer portion is a group of clear glassy cells (*cc.*) enclosing a transparent homogeneous *vitreous body* (*cr.*): the whole of this portion of the eye serves to refract the rays of light—it is the dioptric apparatus, like our own

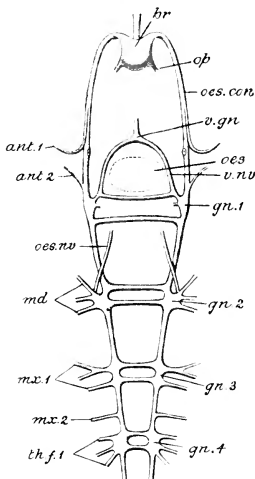

FIG. 434.—Nervous system of **Apus cancriformis**. *ant. 1* nerve to antennule; *ant. 2* to antenna; *br.* brain; *gn. 1-4*, first four ganglia of ventral nerve-cord; *md.* mandibular nerve; *mx. 1*, nerve of first maxilla; *mx. 2*, of second maxilla; *œs. con.*, œsophageal connective; *op.*, optic nerve; *th. f. 1*, nerve of first thoracic foot; *v. gn.* visceral ganglion. (After Lankester and Pelseneer.)

lens and vitreous humour. The inner portion is a group of sensory cells, constituting a *retinula* (*rc.*), and enclosing a refractive rod, the *rhabdome* (*rh.*): the retinula is the actual percipient part of the ommatidium, its cells being comparable to our own rods and cones. The retinulae of adjacent ommatidia are separated from one another by cells full of black pigment (*p.*), so that each ommatidium is in a state of optical isolation from its fellows, and the whole eye is what is called a *compound eye*. The optic nerve springing from the brain dilates into an *optic ganglion*, from which fibres pass to the retinulae.

The *median eye* is an ovoid body, and consists of four groups of large sensory cells enclosing a mass of pigmented tissue: it

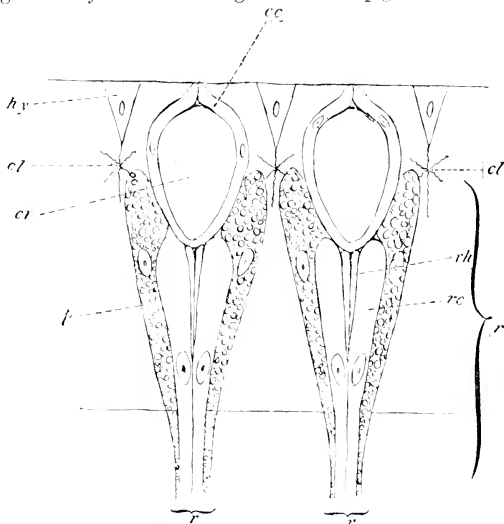

FIG. 435.—Diagram of two ommatidia from the paired eyes of *Apus*. *c.c.* vitreous cells; *cr.* vitreous body; *cl.* connective-tissue fibre; *hy.* epidermal cells; *p.* pigment cells; *r.* inner parts of ommatidia; *rc.* retinula; *rh.* rhabdome. (From Bernard.)

is in immediate contact with the brain, and receives a narrow canal from the water-sac beneath the cuticle of the paired eyes.

Reproductive Organs.—The large majority of individuals both of *Apus* and *Lepidurus* are females; males are of comparatively rare occurrence. The *ovary* (Fig. 431, *ovy.*) is a branched tube occupying a considerable portion of the body-cavity in sexually mature individuals. The walls of the tube are lined with epithelium, and give rise to ova, which pass into the lumen of the tube and thence to a duct (*ovd.*) opening on the eleventh or last thoracic

segment. As in Leeches (p. 503), there is reason for thinking that the cavity of the ovarian tube represents a shut-off portion of the cœlome, and the oviduct a nephridium. One species has been shown to be hermaphrodite: in others males are occasionally found, but reproduction appears to be, as a rule, parthenogenetic.

Development.—The eggs are *centrolecithal*, *i.e.*, have an accumulation of yolk in the centre surrounded by a superficial layer of protoplasm.

The embryo is hatched in the form shown in Fig. 436, *A*. The

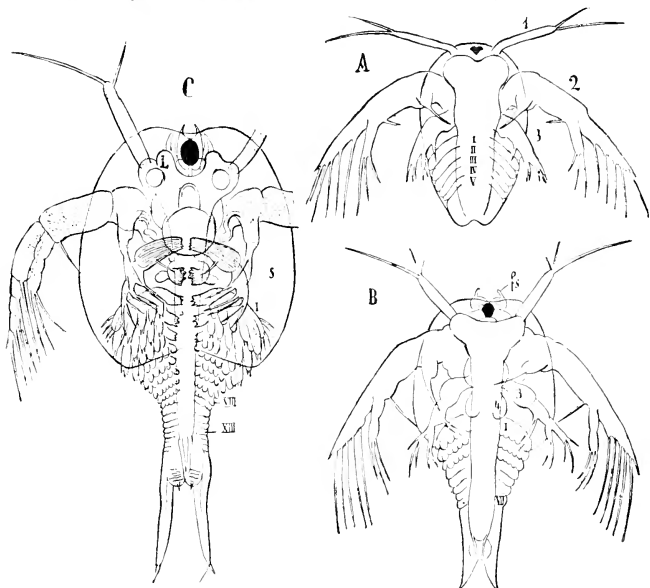

FIG. 436.—Three stages in the development of *Apus*. *fs.* frontal sensory organ; *L*, digestive gland; *s.* carapace; *1*—*4*, cephalic appendages; *1*—*XIII*, body-segments and appendages. (From Lang's *Comparative Anatomy*.)

body is oval, and is divisible into three regions—a large anterior or *head-region*; an intermediate *trunk-region*, the hinder part of which already shows signs of segmentation (*I*–*V*); and a posterior bilobed *anal region*. The head-region bears a single median eye, and a pair of small unjointed appendages (*1*), each with two large setæ at its extremity: these become the antennules of the adult. The trunk-region bears two pairs of appendages, the first of which (*2*) is very large and fringed with setæ, but is chiefly remarkable for being *biramous* or two-branched—being formed of a proximal

portion or stem, the *protopodite*; a small inner branch, the *endopodite*; and a large outer branch, the *exopodite*. This second appendage becomes the antenna of the adult, and may be called the *antennary foot*: it is the chief organ of locomotion of the larva. The second-trunk appendage is the *mandibular foot* (3), so called because it becomes converted into the mandible of the adult: it is also biramous. The only internal structure to be noted is the straight enteric canal with its dilated anterior end or stomach: the mouth opens between the bases of the antennary and mandibular feet, and is bounded in front by a large labrum: the anus is at the extremity of the anal region. This very peculiar and characteristic larval form is called a *nauplius*.¹

The nauplius swims freely, chiefly by vigorous strokes of the great antennary feet, and after a time undergoes a series of moults or *ecdyses*, the cuticle being cast off and the animal emerging in the form shown in Fig. 436, *B*. The trunk-region has elongated, new segments having been added, as in Chætopods, between those previously present and the anal region. The antennules have become shifted backwards, and rudiments of a fourth pair of appendages, the first maxillæ (4), have appeared. The carapace has grown out from the dorsal region of the head, and a peculiar paired sense-organ (*fs.*) has appeared on the head.

After two more ecdyses the larva has assumed the form shown in Fig. 436, *C*. Several new segments have been added, and the anterior of these all bear leaf-like thoracic feet. The antennary feet are still very large, and the bases of the mandibular feet have become enlarged and toothed so as to form biting jaws. The carapace (*s*) has increased greatly, and the caudal styles have attained a considerable size. Further moults occur, new segments are added with their appendages, the antennules and antennæ degenerate—the latter sometimes disappearing altogether, the mandibles become reduced to the enlarged basal segment, and the larva passes by almost insensible gradations into the adult form.

It will be seen that the development of *Apus* proves clearly that the antennæ and mandibles are ordinary trunk-appendages, homologous with the thoracic and abdominal feet: a comparison of the antennary and thoracic feet of the larva supports the view that the endopodite of the former corresponds with the fifth endite of the latter, and the exopodite with the sixth endite. The antennules are from the first unbranched or uniramous, and are originally situated quite at the anterior region of the body: they do not, therefore, show a complete correspondence with the remaining appendages, and, as was inferred from their nerve supply, may perhaps be considered as prostomial and not metameric appendages.

¹ More strictly *metanauplius*: the typical nauplius exhibits no segmentation of the trunk-region.

b. The Fresh-water Crayfish (*Astacus fluviatilis*).

Astacus fluviatilis is common in streams and rivers in England and the continent of Europe; allied species occur in Asia and

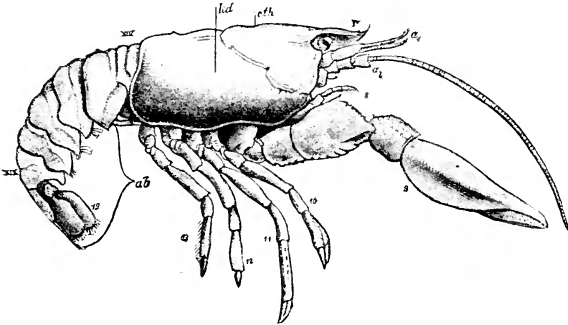

FIG. 437.—*Astacus fluviatilis*, side view of male, *a*¹, antennule; *a*², antenna; *ab*, abdomen; *cth*, cephalothorax; *ld*, gill-cover; *r*, rostrum; *s*, third maxillipede; *9*, first leg; *10-13*, remaining legs; *19*, uropod; *XIV*, first abdominal segment; *XIX*, sixth abdominal segment. (From Lang's *Comparative Anatomy*.)

North America; and fresh-water Crayfishes belonging to other genera, but agreeing with *Astacus* in all essential features, are found in America, Australia, and New Zealand.

External Characters.—The body of the Crayfish (Fig. 437) is divided into two regions—an anterior, the *cephalothorax* (*cth.*), which is unjointed, and is covered by a *carapace* resembling that of *Apus*, but of smaller proportional size; and a posterior, the *abdomen* (*ab*), which is divided into distinct segments, movable upon one another in a vertical plane. The cephalothorax is again divided into two

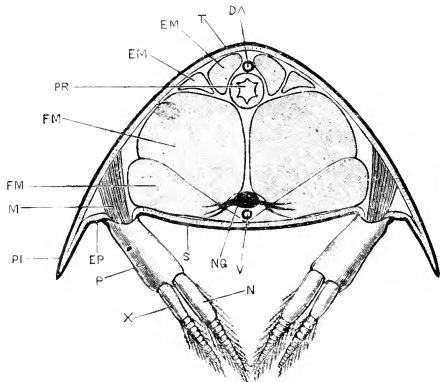

FIG. 438.—Transverse section of abdomen of **Crayfish**. *DA*, dorsal abdominal artery; *EM*, dorsal muscles of the abdomen; *EP*, space between the pleuron and the appendage; *FM*, ventral muscles of the abdomen; *M*, muscles of the appendage; *N*, endopodite; *NG*, nerve-ganglion; *P*, protopodite; *PL*, pleuron; *PR*, hind-gut; *S*, sternum; *T*, tergum; *V*, ventral abdominal artery; *X*, exopodite. (From Parker's *Practical Zoology*, after Marshall and Hurst.)

regions—an anterior, the *head*; and a posterior, the *thorax*—by a transverse depression, the *cervical groove*. The divisions of the body are thus the same as in *Apus*, but the abdomen alone is movably segmented, owing to the fact that the carapace, instead of being a purely cephalic structure continued backwards as a loose fold over the thorax, is developed from the dorsal and lateral regions of both head and thorax, and is free only at the sides of the thorax, where it forms a flap or *gill-cover* (*kd*) on each side, separated from the actual body-wall by a narrow space in which the gills are contained (Fig. 444). The carapace is made of chitin, strongly impregnated with carbonate of lime so as to be hard and but slightly elastic.

The **abdomen** is made up of six segments and a tail-piece or *telson*: the six segments (XIV–XIX) have a ring-like form, presenting a broad dorsal region or *tergum*, a narrow ventral region or *sternum*, and downwardly directed lateral processes, the *pleura*—the last quite unrepresented in *Apus*. The *telson* is flattened horizontally, and divided by a transverse groove into anterior and posterior portions. All the segments and the telson are calcified, and are united to one another by chitinous articular membranes: the first segment is similarly joined to the thorax. Thus the exoskeleton of *Astacus* resembles that of *Apus* in being a continuous cuticular structure, but differs from it in being discontinuously calcified, so as to have the character of a hard jointed armour.

It has been stated that the abdominal segments are movable upon one another in a vertical plane—*i.e.* the whole abdomen can be *extended* or *straightened*, and *flexed* or bent under the cephalothorax: the segments are incapable of movement from side to side. This is due to the fact that, while adjacent segments are connected dorsally and ventrally by flexible articular membranes, they present at each side a *hinge* (Fig. 442, *h*), placed at the junction of the tergum and pleuron, and formed by a little peg-like process of one segment fitting into a depression or socket in the other. A line drawn between the right and left hinges constitutes the *axis of articulation*, and the only possible movement is in a plane at right angles to this axis.

Owing to the presence of the carapace, the **thoracic region** is immovable, and shows no distinction into segments either on its dorsal (tergal) or lateral (pleural) aspect. But on the ventral surface the sterna of the thoracic segments are clearly marked off by transverse grooves, and the hindmost of them is slightly movable. Altogether eight thoracic segments can be counted.

The ventral and lateral regions of the thoracic exoskeleton are produced into the interior of the body in the form of a segmental series of calcified plates, so arranged as to form a row of lateral chambers in which the muscles of the limbs lie, and a median tunnel-like passage or *sternal canal*, containing the thoracic portion

of the nervous system. The entire *endophragmal system*, as it is called, constitutes a kind of internal skeleton: its anterior end is formed by a plate, the *cephalic apodeme*, having the same anatomical relations as the similarly named structure in *Apus*.

The **head** exhibits no segmentation: its sternal region is formed largely by a shield-shaped plate, the *epistoma*, nearly vertical in position. The ventral surface of the head is, in fact, bent so as to face forwards instead of downwards. The epistoma is bounded

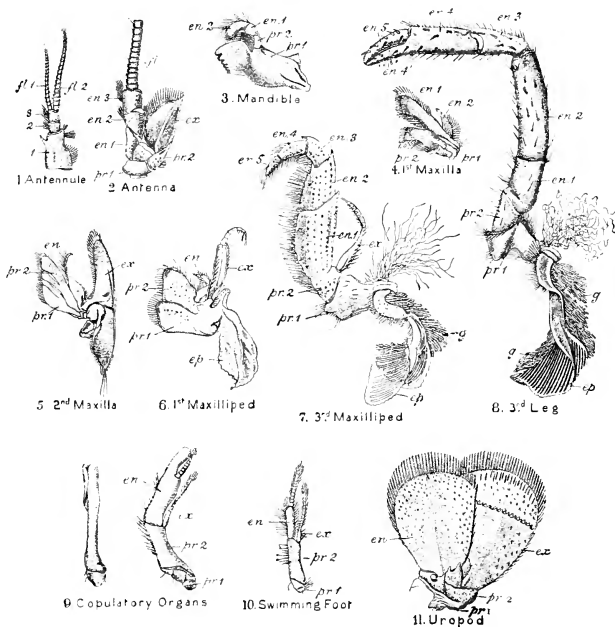

FIG. 439.—Typical appendages of *Astacus*. *en.* 1–5, podomeres of endopodite; *ep.* epipodite; *ex.* exopodite; *fl.* flagella; *g.* gill; *pr. 1, pr. 2,* podomeres of protopodite; 1–3 podomeres of axis of antennule. (After Huxley.)

laterally by the free edge of the carapace instead of passing insensibly into it like the sub-frontal area of *Apus*, with which, however, it agrees in having the *labrum* attached to the middle of its posterior border. The cephalic region of the carapace is produced in front into a large median spine, the *rostrum* (Fig. 437, *r*): immediately below it is a plate from which spring two movably

articulated cylindrical bodies, the *eye-stalks*, bearing the eyes at their ends.

The **appendages** are seen at a glance to differ from those of *Apus* in their vastly greater degree of differentiation: obvious at a glance are the long feelers (Fig. 437, *a. 1*, *a. 2*) attached to the head, the five pairs of legs (9-13) springing from the thorax, and the little fin-like bodies arising from the sterna of the abdomen. It will be convenient to begin with the last-named region.

The third, fourth, and fifth segments of the abdomen bear each a pair of small appendages, the swimming feet or *pleopods* (Fig. 439, *10*), the resemblance of which to the biramous limbs of the larval *Apus* is obvious. There is an axis or *protopodite* consisting of a very short proximal (*pr. 1*) and a long distal (*pr. 2*) podomere, and bearing at its free end two jointed plates, fringed with setæ, the *endopodite* (*en*) and *exopodite* (*ex*). These appendages act as fins, moving backwards and forwards with a regular swing, and probably aiding in the animal's forward movements.

In the female a similar appendage is borne on the second segment, while that of the first is more or less vestigial. In the male the first and second pleopods (9) are modified into incomplete tubes which act as copulatory organs, serving to transfer the spermatophores to the body of the female. The sixth pair of abdominal limbs (11) are alike in the two sexes: they are very large, both endopodite and exopodite having the form of broad flat plates: in the natural position of the parts they lie one on each side of the telson, forming with it a large five-lobed tail-fin capable of being spread out after the manner of a fan; they are therefore conveniently called *uropods* or tail-feet. The telson itself bears no appendages.

The thoracic appendages are very different. The four posterior segments bear long, slender, jointed *legs* (*l*), upon which the animal walks: in front of these is a pair of very large legs terminating in huge claws or *chelæ*, and hence called *chelipeds* (Fig. 437, *9*). The three anterior segments bear much smaller appendages more or less leg-like in form, but having their bases toothed to serve as jaws: they are distinguished as *maxillipeds* or foot-jaws (Fig. 439, *6*, *7*).

The structure of these appendages is best understood by a consideration of the *third maxilliped* (7). The main portion of the limb is formed of seven podomeres arranged in a single series, strongly calcified, and—with the exception of the second and third, which are fused—movably articulated with one another. The second podomere, counting from the proximal end, bears a many-jointed feeler-like organ (*ex*), and from the first springs a thin folded plate (*ep*) having a plume-like gill (*g*) attached to it. Obviously such an appendage is biramous, but with one of its branches greatly in excess of the other: the first two segments of the axis

(*pr. 1*, *pr. 2*) form the protopodite, its remaining five segments (*en. 1-5*) the endopodite, and the feeler, which is directed outwards, or away from the median plane, the exopodite (*ex*). The folded plate (*ep*) is called the *epipodite*: in the natural position of the parts it is directed upwards, and lies in the gill-cavity between the proper wall of the thorax and the gill-cover (Fig. 446). Its position is thus very similar to that of the flabellum of *Apus*, while the gill attached to it is comparable to the bract.

The five *legs* (*S*) differ from the third maxilliped in their greater size, and in having no exopodite: in the fifth or last the epipodite also is absent. The first three of them have undergone a curious modification, by which their ends are converted into pincers or *chela*: the fourth segment (*en. 4*) of the endopodite (sixth of the entire limb) is produced distally so as to form a claw-like projection (*en. 4*¹), against which the terminal segment (*en. 5*) bites. The first leg is much stouter than any of the others, and its chela is of immense size and forms an important weapon of offence and defence. The *second maxilliped* resembles the third, but is considerably smaller: the *first* (*6*) has its endopodite greatly reduced, the two segments of its protopodite large and leaf-like, and no gill is connected with the epipodite.

As in *Apus*, the head bears a pair of mandibles and two pairs of maxillæ in relation with the mouth, and in front of that aperture a pair of antennules and one of antennæ. The hindmost appendage of the head is the *second maxilla* (*5*), a markedly foliaceous appendage: its protopodite (*pr. 1*, *pr. 2*) is cut up into lobes comparable with the four proximal endites in the thoracic feet of *Apus*: its endopodite (*en*) corresponds with the fifth endite, while the sixth endite is represented by the exopodite (*ex*), modified into a boomerang-shaped plate, which, as we shall see, is an important accessory organ of respiration. The *first maxilla* (*4*) is a very small organ, having neither exopodite nor epipodite. The *mandible* (*3*) is a large strongly calcified body, toothed along its inner edge, and bearing on its anterior border a little three-jointed feeler-like body, the *palp*, the two distal segments (*en. 1*, *en. 2*) of which represent the endopodite, its proximal segment (*pr. 2*) together with the mandible proper (*pr. 1*), the protopodite.

The *antenna* (*2*) is of great size, being nearly as long as the whole body. It consists of an axis of five podomeres, the fifth or last of which bears a long, flexible, many-jointed structure, or *flagellum* (*fl*), while from the second segment springs a scale-like body or *squame* (*ex*). It is fairly obvious that the two proximal segments represent the protopodite, the remaining three, with the flagellum, the endopodite, and the squame the exopodite.

The *antennule* (*1*) has an axis of three podomeres (*1-3*) ending in two many-jointed flagella (*fl 1*, and *2*), which are sometimes considered as endopodite and exopodite. But in all the other limbs,

as we have seen, the exopodite springs from the second segment of the axis, and the probabilities are that there is no exact correspondence between the parts of the antennule and those of the remaining appendages.

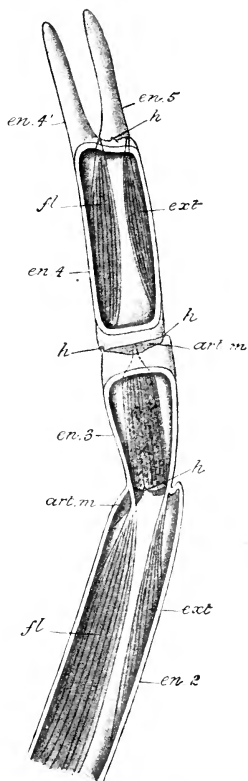

FIG. 440.—Portion of a leg of *Astacus*, with the exoskeleton partly removed, showing articulations and muscles. *art. m.* articular membrane; *en. 2-5*, podomeres of endopodite; *ext.* extensor muscles; *fl.* flexors; *h.* hinge.

is on the same plan as that of the abdominal segments (p. 528). The podomeres are, it must be remembered, rigid tubes: they are connected with one another by flexible *articular membranes* (Fig. 440, *art. m.*), but at two points the adjacent ends of the

The *eye-stalks*, already noticed, arise just above the antennules and are formed each of a small proximal and a large distal segment. They are sometimes counted as appendages serially homologous with the antennæ, legs, &c. But, as we have seen in the case of *Apus*, the appendages of Crustacea are always formed in regular order from before backwards; the eye-stalks, on the other hand, always appear later, both in individual development and in the Crustacean series, than the normal anterior appendages. They are therefore more properly to be looked upon as articulated processes of the prostomium, developed in connection with the need for an increased range of vision. Assuming this to be the case, it will be seen that the body of the Crayfish consists of a prostomium, nineteen metameres, and a telson. The prostomium bears eye-stalks: the first five metameres are fused with the prostomium to form the head, and bear the antennules, antennæ, mandibles, first maxillæ, and second maxillæ: the next eight metameres (6th-13th) constitute the thorax, and bear the three pairs of maxillipeds and the five pairs of legs: the remaining six metameres (14th-19th), together with the telson, constitute the abdomen, and bear five pairs of pleopods and one of uropods.

The **articulation** of the various podomeres of the appendages

tubes come into contact with one another and are articulated by peg-and-socket joints (*h.*), the two joints being at opposite ends of a diameter which forms the *axis of articulation*. The two podomeres can, therefore, be moved upon one another in a plane at right angles to the axis of articulation and in no other direction, the joints being pure hinge-joints. As a rule, the range of movement is from the perpendicular to a tolerably extensive flexion on one side—the articulations are single-jointed, like our own elbows and knees. The whole limb is, however, capable of universal movement, owing to the fact that the axes of articulation vary in direction in successive joints: the first joint of a limb bending, for instance, up and down, the next backwards and forwards, the next obliquely, and so on. In some cases, *e.g.* in the pleopods, peg-and-socket joints are absent, the articulation being formed merely by an annular articular membrane, and movement being therefore possible in any plane.

Body-wall.—The exoskeleton is produced into spines of varying form and size, and many parts of it bear tufts or fringes of setæ, which also exhibit a wide variation in size and form. It is composed of a thick laminated chitinous membrane (Fig. 441, *cu.*), more or less impregnated with lime-salts, and is shed periodically—once a year during adult life. Beneath it is the epidermis (*ep.*) composed of a single layer of cells from which the chitin is secreted, and underlain by a layer of connective-tissue (*c.t.*) to which the muscles are attached.

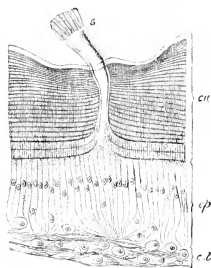

FIG. 441.—Vertical section of skin and exoskeleton of **Lobster**. *c.t.* connective-tissue; *cu.* cuticle; *ep.* epidermis; *s.* seta. (After Gerstaecker.)

The **muscular system**, like the exoskeleton, shows a great advance in complexity over that of *Apus*. In the abdomen (Fig. 442) the muscles are of great size, and are divisible into a smaller dorsal and a larger ventral set. The *dorsal muscles* (*d. m.*) are paired longitudinal bands, divided into myomeres, and inserted by connective-tissue into the anterior border of each segment: anteriorly they are traceable into the thorax, where they arise from the side-walls of that region. When these muscles contract, they draw the anterior edge of each tergum under the posterior edge of its predecessor, and thus extend or straighten the abdomen.

The *ventral muscles* are extraordinarily complex. Omitting details, there is on each side a wavy longitudinal band of muscle (*c. m.*), nearly circular in section, which sends off a slip (*ex.*) to be inserted into each segment above the hinge (*h.*): the contraction of this muscle must obviously tend to approximate the terga, and so aid the dorsal muscles in extending the abdomen. Around this *central*

muscle is wrapped, in each segment, a band of muscle (*env. m.*) in the form of a loop, the outer limb of which turns forwards and is inserted into a sternum, while the inner limb turns backwards and is inserted into another and more posterior sternum. The contraction of this *enveloping muscle* produces an approximation of the sterna, and thus flexes the abdomen, the central muscle always keeping the middle of the loop in place. The ventral muscles are, like the dorsal, traceable into the thorax, where they arise

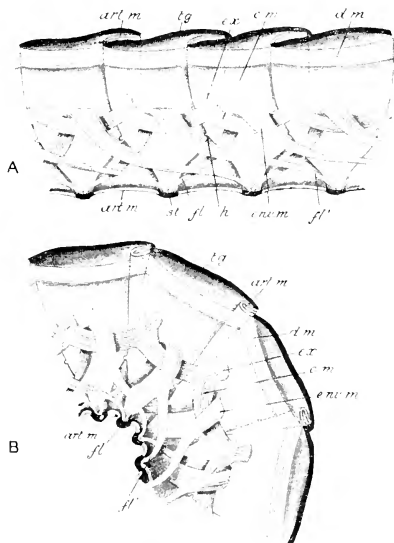

FIG. 442.—Four segments of abdomen of **Crayfish** in sagittal section with muscles (diagrammatic). *A*, extension; *B*, flexion; *art. m.*, *art. m.*, articular membranes; *c. m.*, central muscles; *d. m.*, dorsal muscle; *ex.*, extensor slip of central muscle; *env. m.*, enveloping muscle; *fl.*, *fl.*, flexor slips; *h.*, hinge; *st.*, sternum; *tg.*, tergum.

from the endophragmal system (p. 529): their various parts are connected by a complex system of fibres extending between the central and enveloping muscles, and connecting both with their fellows of the opposite side. The flexor muscles are immensely powerful, and produce, when acting together, a sudden and violent bending of the abdomen upon the cephalothorax, causing the Crayfish to dart backwards with great rapidity.

It will be seen that the body-muscles of the Crayfish cannot be said to form a layer of the body-wall, as in Chætopods, the abdomen of *Apus*, &c., but constitute

an immense fleshy mass, filling up the greater part of the body-cavity, and leaving a very small space around the enteric canal.

In the limbs (Fig. 440) each podomere is acted upon by two muscles situated in the next proximal podomere. These muscles are inserted, by chitinous and often calcified tendons, into the proximal edge of the segment to be moved, the smaller on the extensor (*ext.*), the larger on the flexor (*fl.*) side, in each case half-way between the two hinges, so that a line joining the two muscular insertions is at right angles to the axis of articulation.

The **digestive organs** are constructed on the same general plan as those of *Apus*, but present many striking differences (Fig. 443). The *mouth* lies in the middle ventral line of the head, and is bounded in front by the labrum, at the sides by the mandibles, and behind by a pair of delicate lobes, the *paragnatha*. It leads by a short wide *gullet* (*oe*) into a capacious *gizzard* (sometimes termed *stomach*), which occupies a great part of the interior of the head, and is divided into a large anterior division (*cs*), and a small posterior division (*ps*): the latter passes into a narrow and very short portion of the intestine, the *mid-gut* (*md*), from which the rest of the intestine (*hind-gut*, *hd*) extends to the *anus* (*an*), situated on the ventral surface of the telson.

The outer layer of the enteric canal consists of connective-tissue containing striped muscular fibres: within this is a single layer of columnar epithelial cells. In the gullet and gizzard, and in the hind-gut, the epithelium secretes a layer of chitin, which thus constitutes the innermost lining of those cavities. It is proved by development that the mid-gut, which has no chitinous lining, is the only part of the enteric canal developed from the mesenteron: the gullet and gizzard arise from the stomodæum, the hind-gut from the proctodæum. Thus a very small portion of the enteric epithelium is endodermal.

In the anterior division of the gizzard the chitinous lining is thickened and calcified in certain parts, so as to form a complex articulated framework, the "*gastric mill*," on which are borne a median and two lateral *teeth*, strongly calcified and projecting into the cavity of the gizzard. Two pairs of strong muscles arise from the carapace, and are inserted into the gizzard: when

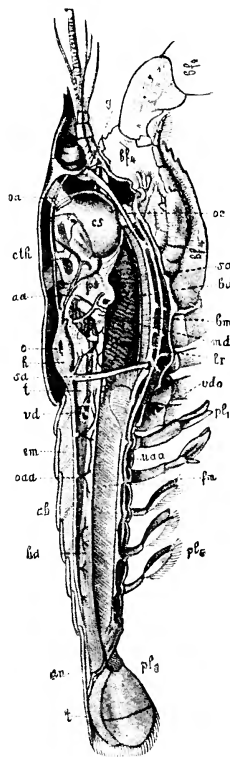

FIG. 443.—*Astacus fluviatilis*, dissection from the right side. *aa*, antennary artery; *ab*, abdomen; *an*, anus; *b, d*, aperture of duct of right digestive gland; *bj, f*, cheliped; *bm*, ventral nerve-cord; *cs*, anterior division of gizzard; *cth*, cephalothorax; *em*, dorsal muscles; *fm*, ventral muscles; *g*, brain; *h*, heart; *hd*, posterior part of intestine; *lr*, left digestive gland; *md*, mid-gut; *o*, ostium of heart; *oa*, right lateral (sternal) artery; *oaa*, dorsal abdominal artery; *oe*, gullet; *pl. 1-5*, pleopods; *pl. 6*, uropod; *ps*, posterior division of gizzard; *sa*, sternal artery; *t*, testis and telson; *uaa*, ventral abdominal artery; *vd*, vas deferens; *vdo*, male genital aperture. (From Lang, after Huxley.)

they contract they move the mill in such a way that the three teeth meet in the middle and complete the comminution of the food begun by the jaws. The separation of the teeth is effected partly by the elasticity of the mill, partly by delicate muscles in the walls of the gizzard. The posterior division of the gizzard

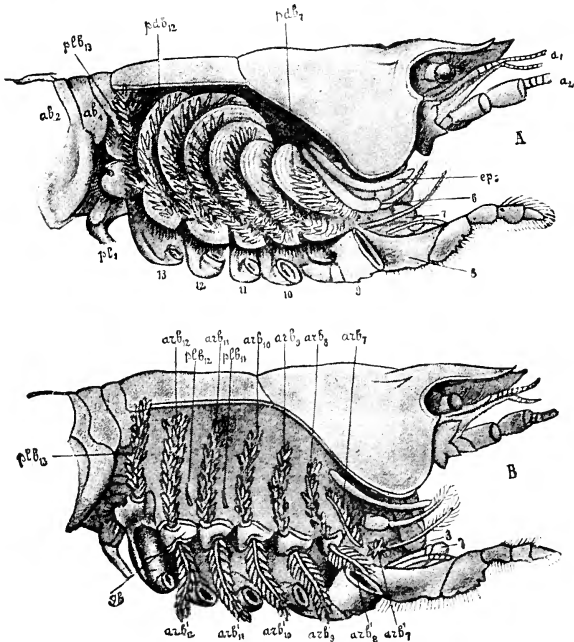

FIG. 444.—Respiratory organs of *Astacus fluviatilis*. In A the gill-cover is removed and the gills undisturbed; in B the podobranchiae are removed and the outer arthrobranchiae turned down. *a₁*, antenna; *a₂*, antenna; *ab₁*, first; *ab₂*, second abdominal segment; *arb₇*—*12*, inner arthrobranchiae; *arb₇*—*12*, outer arthrobranchiae; *ep*, 5, scaphognathite; *pl*, 11—13, pleurobranchiae; *pd*, 7—13, podobranchs; *pl*, 1, first pleopod; 6—13, thoracic appendages. (From Lang's *Comparative Anatomy*, after Huxley.)

forms a strainer: its walls are thickened and produced into numerous setæ, which extend quite across the narrow lumen and prevent the passage of any but finely divided particles into the intestine. Thus the gizzard has no digestive function, but is merely a masticating and straining apparatus. On each side of the anterior division is found at certain seasons of the year a plano-convex mass of calcareous matter, the *gastrolith*.

The digestion of the food and to some extent the absorption of the digested products are performed by a pair of large glands (*lr.*), lying one on each side of the gizzard and anterior end of the intestine. They are formed of finger-like sacs or *cæca*, which discharge into wide ducts opening into the mid-gut, and are lined with glandular epithelium derived from the endoderm of the embryo. The glands are often called livers, but as the yellow fluid they secrete digests proteids as well as fat, the name *hepato-pancreus* is often applied to them, or they may be called simply *digestive glands*. The Crayfish is carnivorous, its food consisting largely of decaying animal matter. Microscopic glands occur in the wall of the gullet.

The digestive organs and other viscera are surrounded by a *body-cavity*, which is in free communication with the blood-vessels and itself contains blood. As will be pointed out more particularly hereafter, this cavity is to be looked upon as an immense blood-sinus, and not as a true cœlome.

There are well-developed **respiratory organs**, in the form of *gills*, contained in a narrow branchial chamber, bounded internally by the proper wall of the thorax (Fig. 446. *ep*), externally by the gill-cover or pleural region of the carapace (*kd*). Each gill consists of a stem giving off numerous branchial filaments, so that the whole organ is plume-like. The filaments are hollow, and communicate with two parallel canals in the stem—an external, the *afferent branchial vein*, and an internal, the *efferent branchial vein*. The gill is to be considered as an out-pushing of the body-wall, and contains the same layers—a thin layer of chitin externally, then a single layer of epithelial cells, and beneath this connective-tissue, hollowed out for the blood channels and containing gland-cells, which will be referred to presently (p. 539).

According to their point of origin, the gills are divisible into three sets—first, *podobranchiæ* or foot-gills, springing from the epipodites of the thoracic appendages, from which they are only partially separable; secondly, *arthrobranchiæ* or joint-gills, springing from the articular membranes connecting the thoracic appendages with the trunk; and thirdly, *pleurobranchiæ*, or wall-gills, springing from the lateral walls of the thorax, above the attachment of the appendages. It is inferred from the study of other Crayfishes, that a typical thoracic segment bears four gills, one podobranch, two arthrobranches, and one pleurobranch. But in *Astacus* one or more of the gills in every segment are absent or vestigial, and the table, or “branchial formula,” on page 538 shows the actual number and arrangement of these organs, *ep* standing for epipodite, and *r* for the vestige of a gill.

By adding up the columns vertically we get the number of gills in each segment; by adding them horizontally, the number of each kind of gill; and by adding together the results obtained by both

methods, the total number of gills, viz., eighteen complete gills with two vestiges and seven epipodites.

THORACIC SEGMENTS.	I.	II.	III.	IV.	V.	VI.	VII.	VIII.	TOTAL.
Zodobranchiæ . .	0- <i>cp</i>	1+ <i>cp</i>	1+ <i>cp</i>	1+ <i>cp</i>	1+ <i>cp</i>	1- <i>cp</i>	1+ <i>cp</i>	0	6+7 <i>cp</i>
Arthrobranchiæ	0	1	2	2	2	2	2	0	11
Pleurobranchiæ	0	0	0	0	0	<i>r</i>	<i>r</i>	1	1-2 <i>r</i>
TOTAL . .	0+ <i>cp</i>	2+ <i>cp</i>	3+ <i>cp</i>	3+ <i>cp</i>	3+ <i>cp</i>	3+ <i>c+cp</i>	3+ <i>r+cp</i>	1	18-2 <i>r</i> -7 <i>cp</i>

The excretory organs differ both in position and in form

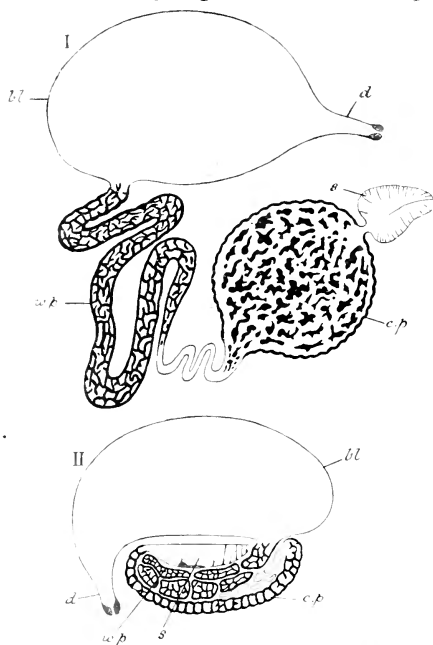

FIG. 445.—Diagram of kidney of *Astacus fluviatilis*. I, untraveled; II, the parts in their natural relations. *bl*, bladder; *c. p.*, cortical portion; *d*, duct; *s*, sacculus; *w. p.*, white portion. (After Marchal.)

from those of *Apus*. There are no shell-glands, but at the base of each antenna is an organ of a greenish colour, the *antennary* or *green gland*, by which the function of renal excretion is performed. The gland (Fig. 445) is cushion-shaped, and consists of three parts—(1) a central *sacculus* (*s.*) of a yellowish colour, occupying the mid-dorsal region, and consisting of a sac divided into numerous compartments by partitions, and communicating with (2) the outer or *cortical portion* (*c. p.*), of a green colour, consisting

of a glandular network formed of anastomosing canals, and communicating in its turn with (3) a *white portion (w. p.)*, formed of a single tube partly converted into a sponge-work by ingrowths of its walls. The whole organ is lined by glandular epithelium, and the white portion discharges into a thin-walled sac or *urinary bladder (bl.)* which opens by a *duct (d.)* on the proximal segment of the antenna. The glands already referred to as occurring in the gills are also supposed to have an excretory function.

The **circulatory organs** are in a high state of development. The *heart* (Figs. 443, 446. *h.*) is situated in the dorsal region of the thorax, and is a roughly

polygonal muscular organ pierced by three pairs of apertures or *ostia (o.)*, guarded by valves which open inwards. It is enclosed in a spacious *pericardial sinus* (Fig. 446. *pc.*), which contains blood. From the heart spring a number of narrow tubes, called *arteries*, which serve to convey the blood to various parts of the body. At the origin of each artery from the heart are valves which allow of the flow of blood in one direction only, viz., from the heart to the artery. From the anterior end of the heart arise five vessels—the median *ophthalmic artery* (Fig. 443. *oa.*), which passes forwards to the eyes; paired *antennary arteries (aa.)*, going to the antennules, antennæ, green glands, &c., and sending off branches to the gizzard; and paired *hepatic arteries*, going to the digestive glands.

The posterior end of the heart gives off two unpaired arteries practically united at their origin, the *dorsal abdominal artery (oaa.)*, which passes backwards above the intestine, sending branches to it and to the dorsal muscles; and the large *sternal artery (sa.)*, which extends directly downwards, indifferently to right or left of the intestine, passing between the connectives uniting the third and fourth thoracic ganglia, and then turns forwards and runs in the sternal canal, immediately beneath the nerve-cord, sending off branches

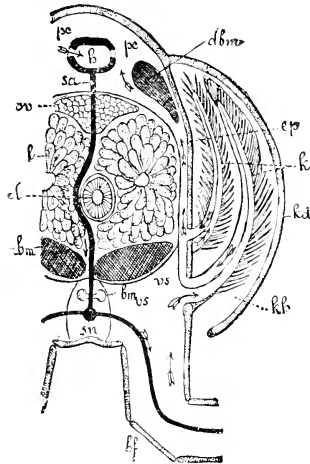

FIG. 446.—Transverse section of thorax of **Crayfish**, diagrammatic. *abm.* ventral abdominal muscles; *lf.* leg; *bm.* ventral nerve cord; *d.* intestine; *dbm.* dorsal muscles of abdomen; *ep.* wall of thorax; *h.* heart; *k.* gills; *kd.* gill-cover; *l.* digestive gland; *ov.* ovary; *pc.* pericardial sinus; *sa, sn.* sternal artery; *vs.* ventral sinus. The arrows show the direction of the blood-current. (From Lang's *Comparative Anatomy.*)

to the legs, jaws, &c. At the point where the sternal artery turns forwards it gives off the median *ventral abdominal artery* (*uaa.*), which passes backwards beneath the nerve-cord, and supplies the ventral muscles, pleopods, &c.

All these arteries branch extensively in the various organs they supply, becoming divided into smaller and smaller offshoots, which finally end in microscopic vessels called *capillaries*. These latter end by open mouths which communicate with the *blood-sinuses* (Fig. 447, *s.*), spacious cavities lying among the muscles and viscera,

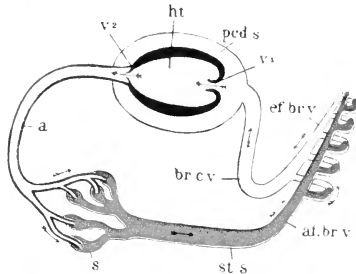

FIG. 447.—Diagram of the circulation in the **Crayfish**; heart and arteries scarlet, veins and sinuses containing non-aërated blood, blue; those containing aërated blood, pink. *a.* artery; *af.br.v.* afferent branchial vein; *br.c.v.* branchio-cardiac vein; *ef.br.v.* efferent branchial vein; *ht.* heart; *pcd.s.* pericardial sinus; *s.* sinus; *st.s.* sternal sinus; *v¹.* ostium with valves; *v².* arterial valves. The arrows show the direction of the current.

and all communicating, mediately or immediately, with the *sternal sinus* (*st.s.*), a great median canal running longitudinally along the thorax and abdomen, and containing the ventral nerve-cord and the sternal and ventral abdominal arteries. In the thorax the sternal sinus sends an offshoot to each gill in the form of a well-defined vessel, which passes up the outer side of the gill and is called the *afferent branchial vein* (*af.br.v.*; see also Fig. 446). Spaces in the gill-filaments place the afferent in communication with the *efferent branchial vein* (*ef.br.v.*), which occupies the inner side of the gill-stem. The eighteen efferent branchial veins open into six *branchiocardiac veins* (*br.c.v.*), which pass dorsally in close contact with the lateral wall of the thorax and open into the pericardial sinus (*pcd.s.*).

The whole of this system of cavities is full of blood, and the heart is rhythmically contractile. When it contracts, the blood contained in it is prevented from entering the pericardial sinus by the closure of the valves of the ostia, and therefore takes the only other course open to it, viz., into the arteries. When the heart relaxes, the blood in the arteries is prevented from regurgitating by the valves at their origins, and the pressure of blood in the pericardial sinus forces open the valves of the ostia and so fills

the heart. Thus in virtue of the successive contractions of the heart and of the disposition of the valves, the blood is kept constantly moving in one direction—viz., from the heart by the arteries to the various organs of the body, where it receives carbonic acid and other waste matters; thence by sinuses into the great sternal sinus; from the sternal sinus by afferent branchial veins to the gills, where it exchanges carbonic acid for oxygen; from the gills by efferent branchial veins to the branchiocardiac veins, thence into the pericardial sinus, and so to the heart once more.

It will be seen that the circulatory system of the Crayfish consists of three sections—(1) the *heart* or organ of propulsion; (2) a system of out-going channels, the *arteries*, which carry the blood from the heart to the body generally; and (3) a system of returning channels, some of them, the *sinuses*, mere irregular cavities; others, the *veins*, with definite walls, which return it from the various organs back to the heart. The respiratory organs, it should be observed, are interposed in the returning current, so that blood is taken both to and from the gills by veins.

Comparing the blood-vessels of *Astacus* with those of a *Chætopod*, it would seem that the ophthalmic artery, heart, and dorsal abdominal artery together answer to a dorsal vessel, part of which has become enlarged and muscular and discharges the whole function of propelling the blood. The horizontal portion of the sternal artery, together with the ventral abdominal, represent a ventral vessel; while the vertical portion of the sternal artery is a commissure, developed sometimes on the right, sometimes on the left side, its fellow being suppressed.

The blood when first drawn is colourless, but after exposure to the air takes on a bluish-grey tint. This is owing to the presence of a colouring matter called *hæmocyanin*, which becomes blue when combined with oxygen; it is a respiratory pigment, and serves, like hæmoglobin, as a carrier of oxygen from the external medium to the tissues. The hæmocyanin is contained in the plasma of the blood: the corpuscles are all colourless leucocytes.



FIG. 448.—Nervous system of *Astacus fluviatilis*. *bg.*, sub-oesophageal ganglion; *cg.*, commissural ganglion; *g.*, brain; *s.*, visceral nerve; *sc.*, oesophageal connective; *u.*, post-oesophageal commissure; IV—VIII, thoracic ganglia; 1-6, abdominal ganglia. (From Lang's *Comparative Anatomy*, after Vogt and Yung.)

The **nervous system** (Fig. 448) consists, like that of *Apus*, of a brain (*g*) and a ventral nerve-cord, united by œsophageal connectives (*sc*). But the right and left halves of the ventral cord have undergone partial fusion, so that the ganglia, and in the abdomen the connectives also, appear single instead of double. Moreover, the brain supplies not only the eyes and antennules, but the antennæ as well, and it is found by development that the two pairs of ganglia belonging to the antennular and antennary segments have fused with the brain proper. Hence we have to distinguish between a primary brain or *archi-cerebrum*, the ganglion of the prostomium, and a secondary brain or *syn-cerebrum* formed by the union of one or more pairs of ganglia of the ventral cord with the *archi-cerebrum*. A further case of condescence of ganglia is seen in the ventral nerve-cord, where the ganglia of the last three cephalic and first three thoracic segments have united to form a large compound *sub-œsophageal ganglion* (*bg*). All the remaining segments have their own ganglia, with the exception of the telson, which is supplied from the ganglion of the preceding segment. There is a *visceral system* of nerves (*s*) supplying the gizzard, originating in part from the brain and in part from the œsophageal connectives.

Sensory Organs.—The *eyes* have the same essential structure as the compound eye of *Apus*. The chitinous cuticle covering the distal end of the eye-stalk is transparent, is divided by delicate lines into square areas or *facets*, and constitutes the *cornea*. Beneath each facet of the cornea is an ommatidium, optically separated from its neighbours by black pigment, and consisting of an outer segment or *vitreous body*, and an inner segment or *retinula*, formed of sensory cells enclosing a rhabdome.

The antennules contain two sensory organs, to which have been assigned the functions of smell and hearing respectively. The *olfactory organ* is constituted by a number of extremely delicate *olfactory setæ*, borne on the external flagellum and supplied by branches of the antennular nerve. The so-called *auditory organ* is a sac formed by invagination of the dorsal surface of the proximal segment, and is in free communication with the surrounding water by a small aperture. The chitinous lining of the sac is produced into delicate feathered *auditory setæ*, supplied by branches of the antennular nerve; and in the water which fills the sac are minute sand-grains, which take the place of otoliths, but, instead of being formed by the animal itself, are taken in after each ecdysis, when the lining of the sac is shed. Probably the main function of these organs (*statocysts*) is connected with the equilibration of the body rather than with the sense of hearing. Many of the setæ on the body generally have a definite nerve-supply, and are probably *tactile organs*.

Reproduction.—The Crayfish is diœcious, and presents a very obvious sexual dimorphism. The abdomen of the female is much

broader than that of the male: the first and second pleopods of the male are modified into tubular or rather spout-like copulatory organs (Fig. 439, 9); and the reproductive aperture is situated in the male on the proximal podomere of the fifth leg, in the female on that of the third.

The *testis* (Fig. 449, *B*, *t*, *u*) lies in the thorax, just beneath the floor of the pericardial sinus, and consists of paired anterior lobes (*t*) and an unpaired posterior lobe (*u*). From each side goes off a convoluted *vas deferens* (*vd*), which opens on the proximal segment of the last leg. The *sperms* are curious amœboid bodies produced into a number of stiff processes or pseudopodia (Fig. 23, *f*): they are aggregated into vermicelli-like *spermatophores* by a secretion of the vas deferens.

The *ovary* (*A*, *ov*, *u*) is also a three-lobed body, and is similarly situated to the testis: from each side proceeds a thin-walled

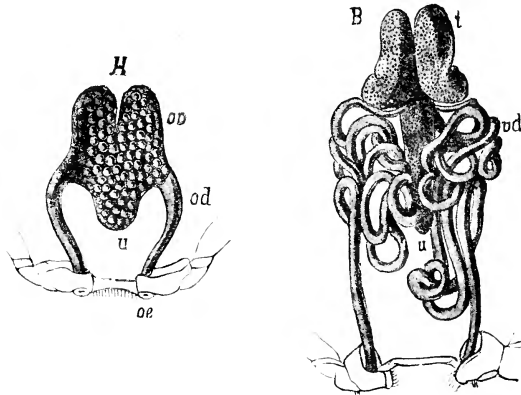

FIG. 449.—Reproductive organs of *Astacus fluviatilis*. *A*, female; *B*, male. *od*, oviduct; *oe*, its external opening; *ov*, ovary; *t*, testis; *u*, unpaired posterior portion of gonad; *vd*, vas deferens. (From Lang's *Comparative Anatomy*, after Huxley.)

oviduct (*od*), which passes downwards, without convolutions, to open on the proximal segment of the third or antepenultimate leg. The eggs are of considerable size and are centrolecithal.

As in *Apus*, both ovary and testis are hollow organs, discharging their products internally. The ova, when laid, are fastened to the setæ on the pleopods of the female by the sticky secretion of glands occurring both on those appendages and on the segments themselves: they are fertilised immediately after laying, the male depositing spermatophores on the ventral surface of the female's body just before oviposition.

Development.—The process of *segmentation of the oosperm* presents certain striking peculiarities. The nucleus (Fig. 450, *A*, *nu*) divides repeatedly, but no corresponding division of the protoplasm takes place, with the result that the morula-stage, instead of being

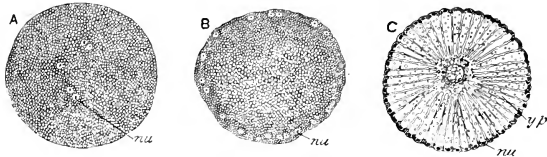

FIG. 450.—Three stages in the formation of the blastoderm of *Astacus fluviatilis*. *nu*, nuclei; *yp*, yolk-pyramids. (From Korschelt and Heider, after Morin and Reichenbach.)

a heap of cells, is multinucleate but non-cellular. Soon the nuclei thus formed retreat from the centre of the embryo, and arrange themselves in a single layer close to the surface (*B*): around each of these protoplasm accumulates, the central part of the embryo consisting entirely of yolk-material. We thus get a *superficial segmentation*, characterised by a central mass of yolk and a

superficial layer of cells collectively known as the *blastoderm* (*C*). Subsequently the yolk itself undergoes a process of segmentation, becoming divided into radiating *yolk pyramids* (*y.p.*), each with its base in contact with one of the cells of the blastoderm and its apex pointing to the centre of the egg: before long, however, these pyramids fuse into an undivided mass of yolk.

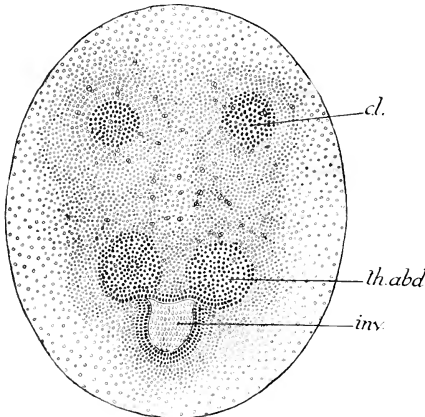

FIG. 451.—Ventral view of an embryo of *Astacus fluviatilis*, gastrula stage, in order to show the ventral plate. *cl.*, cephalic lobe; *inv.*, invaginated area of blastoderm (endoderm disc); *th. abd.*, thoraco-abdominal rudiments. (From MacBride, after Reichenbach.)

The first indications of the future Crayfish take the form of thickenings on what will become the ventral surface. There are at first five of these thickenings—two anterior, the *head-lobes*

(Fig. 451, *c. l.*), on which the eyes subsequently appear; two somewhat further back, the *thoracico-abdominal rudiments* (*th. abd*); and one, posterior and unpaired, the *endoderm-disc* (*inv*). On the latter an invagination of the blastoderm takes place, giving rise to a small sac, the *archenteron*, which communicates with the exterior by an aperture, the *blastopore*. By this process the embryo passes into the *gastrula-stage*, which, however, differs from the corresponding stage in the types previously studied in the immense quantity of food-yolk filling up the space (blastocœle) between ectoderm and endoderm. Very soon the embryo becomes triploblastic, or three-layered, by the budding off of cells from the endoderm in the neighbourhood of the blastopore: these accumulate between the ectoderm and endoderm, and constitute the mesoderm.

Before long the blastopore closes, converting the archenteron into a shut sac (Fig. 453, *A*): the thoracico-abdominal rudiments unite with one another, forming a well-marked oval elevation (Fig. 452, *th. abd*), and three pairs of elevations appear between it and the head-lobes. These are the rudiments of the first three

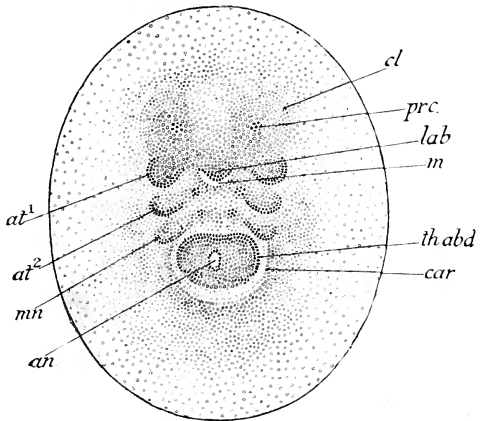

Fig. 452.—“Nauplius stage” in the development of *Astacus fluviatilis* viewed from the ventral side. *an*, anus; *at¹*, rudiment of antennule; *at²*, rudiment of antenna; *car*, ridge marking the first trace of the carapace; *cl*, cephalic lobe; *lab*, labrum; *m*, mouth; *mn*, rudiment of mandible; *prc*, protocerebrum; *th.abd*, thoracico-abdominal rudiment. (From MacBride, after Reichenbach.)

pairs of appendages, the antennules (*at¹*), antennæ (*at²*), and mandibles (*mn*): by their appearance the embryo passes into the *nauplius-stage*, which in this case is passed through in the egg, instead of being active and free-swimming as in *Apus*.

Between the bases of the antennules and antennæ a pit appears, which soon deepens and widens: this is the *stomodæum* (Fig. 453, *stdm.*), and its aperture the mouth. A similar but narrower and more cylindrical pit appears on the thoracico-abdominal rudiment: this is the *proctodæum* (*pcdm.*), and its aperture the anus. For a considerable time both stomodæum and proctodæum remain in the condition of blind sacs, but after a time they open into the

archenteron, a complete enteric canal being thus constituted. In the meantime the endoderm cells lining the archenteron grow outwards in a radial direction, ingesting the yolk as they do so, until they take the form of long columns, in contact by their outer ends with the ectoderm (Fig. 453, *B*).

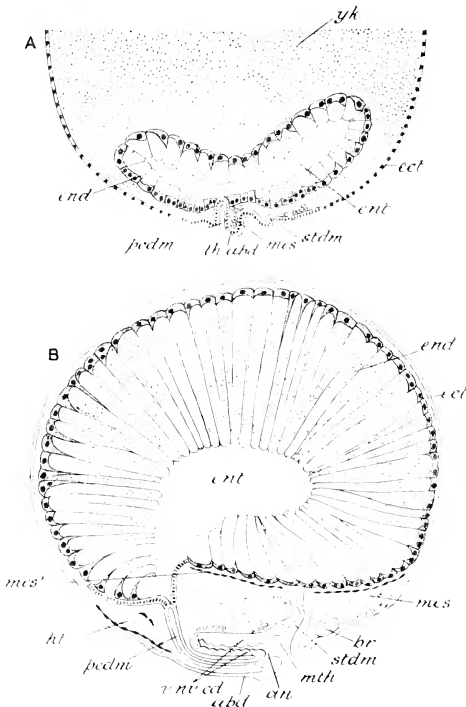

FIG. 453.—Sections of embryos of *Astacus*. *A*, Nauplius-stage (compare Fig. 452); *B*, after development of thoracic appendages (cf. Fig. 451). *abd.*, abdomen; *an.*, anus; *br.*, brain; *ect.*, ectoderm; *end.*, endoderm; *ent.*, enteron; *ht.*, heart; *mes.*, mesoderm; *mes'*, splanchnic layer of mesoderm; *mth.*, mouth; *pedm.*, proctodaeum; *stdm.*, stomodaeum; *th. abd.*, thoraco-abdominal rudiment; *v. n. c.*, ventral nerve-cord. (From Korschelt and Heider, after Reichenbach.)

The thoraco-abdominal rudiment soon begins to increase rapidly in length, but, being enclosed in the egg-membranes, it grows not backwards but forwards, being in fact folded upon the anterior part of the body in much the same way as the abdomen of the adult during extreme flexion.

In the meantime the post-mandibular appendages are formed in regular order from before backwards: the eye-stalks appear (Fig. 454, *oc*), as well as the labrum (*lab*), and a fold on each side of the thorax, which is the rudiment of the carapace (*car*), and this gradually extends dorsally until it meets with its fellow of the opposite side and covers in the cephalothorax. The embryo now consists of a nearly globular cephalothorax with a small abdomen and a nearly complete set of appendages, all tucked in under the cephalothorax and closely packed together within the egg-membranes. In this condition the embryo is hatched, and for some time clings to the pleopods of the mother or to the empty egg-shells by means of the peculiarly hooked chelæ of its first pair of legs, and is attached also by a bundle of threads secreted along the posterior border of the larval telson.

The development of the principal internal organs must be referred to very briefly. From the ectoderm

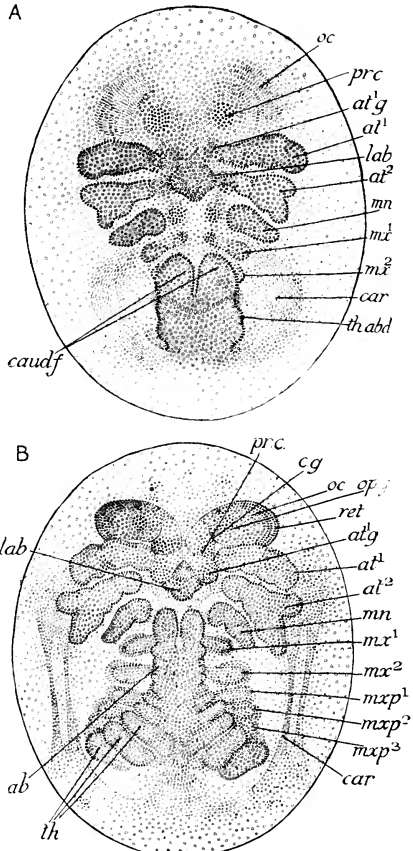

FIG. 454.—*Astacus fluviatilis*. Two views of eggs showing stages in the development of the appendages. *A*, stage in which the rudiments of maxillæ have appeared and in which the abdomen has become forked. *B*, stage in which the rudiments of thoracic appendages are appearing and in which the abdomen is segmented. *ab*, abdomen; *at*¹, antennule; *at*², antenna; *at*^{1g}, antennular ganglion; *car*, fold which becomes edge of the carapace; *caud. f.*, forked extremity of abdomen; *c.g.*, cerebral groove which gives rise to the optic ganglion; *lab*, labrum; *mn*, mandible; *mx*¹, first maxilla; *mx*², second maxilla; *mxp*¹, *mxp*², *mxp*³, maxillipedes; *oc*, eye-stalk; *op. g.*, optic ganglion; *pr. c.*, protocerebrum; *ret.*, retinule; *th.*, rudiments of thoracic appendages. (From MacBride, after Reichenbach.)

arise not only the epidermis of the adult, but the epithelium of the gullet and gizzard and of the hind-gut, the epithelium of the gills, the nervous system, the vitreous cells and retinulæ of the eyes, and the epithelium of the auditory sac. From the endoderm arises the epithelium of the mid-gut and of the digestive glands, the latter being formed as tubular branching outgrowths of the archenteron. The connective-tissues, the muscles, the vascular system, the gonads, and perhaps the kidneys, are all of mesodermal origin.

2. DISTINCTIVE CHARACTERS AND CLASSIFICATION.

The Crustacea are Arthropods in which the five anterior segments are fused with the prostomium to form the head, while the rest are usually divisible into two regions, the thorax and the abdomen. More or fewer of the thoracic segments may be fused with the head to form a cephalothorax. The head may bear a median eye, which frequently disappears in the adult, and a pair of compound eyes, both belonging to the prostomial region: the latter frequently become elevated on jointed eye-stalks. The appendages of the head are (1) the antennules, which are usually considered as belonging to the first metamere; (2) the antennæ, which are certainly post-oral or metameric appendages shifted forwards to a pre-oral position; (3) the mandibles or crushing jaws; (4) the first maxillæ; and (5) the second maxillæ. The thoracic and abdominal appendages are variously modified as jaws, legs, fins, or accessory reproductive organs. With the exception of the antennules, the appendages are typically biramous, consisting of a stem or protopodite bearing two branches, the endopodite and exopodite.

The body is covered externally by a chitinous cuticle, which becomes thickened and sometimes calcified in regions where no movement is required, forming a series of hard parts or *sclerites*, separated by flexible chitin: the whole chitinous cuticle thus constitutes an exoskeleton. Typically there is one sclerite to each metamere behind the head, and to each podomere in the appendages, but conrescence of sclerites frequently takes place. The exoskeleton is produced into setæ, which are hollow processes of the cuticle containing prolongations of the underlying epidermis.

Respiration takes place either by the general surface of the body or by gills, which are hollow offshoots of the thoracic wall or of the thoracic or abdominal limbs. The stomodæum and proctodæum form a considerable portion of the enteric canal, and are lined with chitin: the mesenteron gives rise to digestive glands. The body-cavity is divided into compartments, most of which contain blood and are portions of the vascular system: the true cœlome may be represented by compartments of the body-cavity not containing blood and by the cavities of the reproductive organs. There is a vascular system which nearly always includes a con-

tractile heart, formed as a muscular dilatation of a dorsal vessel, and communicating by valvular ostia with an enclosing pericardial sinus. The blood is taken from the heart to the various organs by arteries, and is returned to the pericardial sinus by sinuses and veins: the respiratory organs are interposed in the returning current. The renal organs are peculiarly modified nephridia, which may take the form either of shell-glands opening on the second maxillæ, or of antennary (green) glands opening on the antennæ.

The nervous system consists of a brain united by œsophageal connectives with a ventral nerve-cord, formed of a double chain of ganglia joined together by commissures and connectives. The first three pairs of embryonic ganglia commonly unite to form the brain, which is therefore a syn-cerebrum. The sexes are separate or united: sexual dimorphism is common: parthenogenesis frequently occurs. The sperms are either amœboid with radiating stiff processes or pseudopodia, or flagellate: the eggs are usually centrolecithal, but may be telolecithal, or almost alecithal. The muscles are striped, and there are no cilia.

Segmentation of the oosperm is usually superficial, but may be complete or discoid. The embryo very usually has a distinct nauplius-stage, which may be a free-swimming larva or may be passed through before hatching, and is characterised by the presence of three pairs of appendages which become the antennules, antennæ, and mandibles of the adult.

The Crustacea are classified as follows:—

Sub-class I.—Branchiopoda.

Crustacea with a varying number of body-segments, provided with appendages of a uniform character, usually foliaceous, rarely leg-like, the posterior region (abdomen) devoid of appendages and provided with a pair of many-jointed or unjointed caudal styles. A cephalic carapace is sometimes absent: when present it may be either shield-like or bivalve. Paired eyes are usually present. The antennules and the maxillæ are reduced or absent: the mandibles devoid of, or with a vestigial, palp. The larva is a nauplius or metanauplius.

ORDER I.—ANOSTRACA.

Branchiopoda in which a carapace is not developed. The eyes are stalked: the antennæ are prehensile in the male, reduced in the female. The appendages of the body-segments number 11 or 19 pairs. The caudal styles are not jointed.

This order includes *Branchipus* and *Artemia*.

ORDER 2.—NOTOSTRACA.

Branchiopoda in which there is a large dorsal shield-shaped carapace. The eyes are sessile. The antennæ are reduced. There are 40 to 63 pairs of trunk appendages. The caudal styles are many-jointed.

Including *Apus* and *Lepidurus*.

ORDER 3.—CONCHOSTRACA.

Branchiopoda with a carapace divided into two lateral portions or valves like the shell of a bivalve mollusc, and enclosing the entire animal. The antennæ are biramous and are used as swimming appendages. The eyes are sessile, coalescent. The appendages of the body-segments number 10 to 27 pairs. The caudal styles are in the form of unjointed, curved claws.

In this order are included *Estheria*, *Limnetis* (Fig. 455), and one or two other genera.

ORDER 4.—CLADOCERA.

Branchiopoda of small size with a bivalved carapace which encloses the trunk but not the head. The eyes are sessile and united together. The antennæ are biramous and used as swimming appendages. Only 4 to 6 trunk appendages; caudal styles unjointed, claw-like.

To this order belong *Daphnia*, *Polyphemus*, *Leptodora* (Fig. 456), etc.

Sub-Class II.—Ostracoda.

Crustacea with unsegmented or indistinctly segmented body, bearing not more than four pairs of appendages on the trunk, the limbless posterior part provided with a pair of caudal styles. There is a well-developed bivalved carapace. Paired eyes may be present or absent. Both antennules and antennæ are used in swimming; the latter are generally biramous. The mandibles have a palp. The young escapes from the egg as a nauplius.

In this sub-class are comprised *Cypris*, *Cythere*, etc. (Fig. 457).

Sub-class III.—Copepoda.

Crustacea with elongated, distinctly segmented body, bearing usually five pairs of limbs, the last four having the character of biramous swimming appendages, sometimes with a sixth pair which may be vestigial: the posterior region (abdomen) without appendages, provided with a pair of caudal styles. The cephalic dorsal shield is not extended backwards, but usually coalesces with the exoskeleton of the first (and sometimes also the second) body-segment. Paired eyes are absent except in the Branchiura. Both

antennules and antennæ are usually well developed, and the latter are sometimes biramous: they may both be used as swimming organs or for prehension. The mandibles may be provided with a palp. The young is a nauplius. In the parasitic forms more or fewer of these general characteristics may become lost in the adult.

ORDER 1.—EUCOPEPODA.

Free or parasitic Copepoda without paired compound eyes. The appendages of the body-segments are devoid of a flagellum. The genital apertures are situated on the seventh body-segment. In this group are included (a) free-swimming forms, such as *Cyclops* (Water-flea) (Fig. 458), and (b) parasitic forms or Fish-lice—e.g., *Ergasilus*, *Chondracanthus*, *Lernæa* (Fig. 459).

ORDER 2.—BRANCHIURA.

Parasitic Copepoda with compound eyes and a suctorial mouth. Some of the appendages of the body-segments are usually provided with peculiar appendages—the *flagella*. The genital apertures are situated on the fifth body-segment. This order includes the Carp-lice, *Argulus* (Fig. 460), and two other genera.

Sub-class IV.—Cirripedia.

Imperfectly segmented Crustacea, which are always fixed in the adult condition, and may be parasitic. There are usually six pairs of biramous cirriform appendages of the body region. The limbless posterior region (abdomen) is rudimentary, and is usually provided with a pair of caudal styles. The carapace forms a pair of folds, the mantle, completely enclosing the animal, and usually supported by a system of calcareous plates giving rise to a hard shell. Paired eyes are absent in the adult. The antennules of the larva give rise to organs of attachment and become vestigial in the adult: the antennæ usually disappear. The mandibles have no palp. The sexes are united in the great majority. The young animal is hatched in the nauplius form and passes later through a stage—the *cypris* stage—in which it is provided with a bivalved shell.

ORDER 1.—EUCIRRIPEDIA.

Cirripedia some of which are parasitic, while the rest are non-parasitic but are permanently fixed in the adult condition. There are usually six pairs of biramous trunk appendages.

In this order are included (a) fixed forms such as *Lepas* (Barnacle) (Fig. 461) and *Balanus* (Acorn-shell) (Fig. 462) and (b) parasites—e.g., *Petrarca*, *Alcippe*, *Proteolepas*.

ORDER 2.—RHIZOCEPHALA.

Parasitic Cirripedia in which the body has undergone extreme degeneration, and has lost all trace of appendages and of alimentary canal in the adult condition.

Including *Sacculina* (Fig. 463) and *Peltogaster*.

Sub-class V.—Malacostraca.

Crustacea in which the body is always distinctly segmented and is made up in all cases except the Leptostraca of an anterior region (thorax) of eight segments, and a posterior (abdomen) of six, with a terminal tail-piece or telson—the total number of segments, leaving the prostomium and the telson out of account, being always nineteen. The appendages of the thorax and abdomen are sharply marked off from one another. The abdomen is devoid of caudal styles. The exoskeleton of the head united with that of more or fewer of the thoracic segments to form a cephalothoracic carapace. Paired eyes are usually present and may be sessile or stalked. The antennules are biramous in most cases. The mandibles are provided with a palp. There is usually a metamorphosis, but a nauplius-stage rarely occurs.

Series I.—Leptostraca (Phyllocarida).

Malacostraca in which the abdomen contains seven segments and a telson—the last segment devoid of appendages, the telson bearing a pair of caudal styles. There is a large bivalved carapace with an adductor muscle, enclosing the greater part of the body. The thoracic appendages are foliaceous, the abdominal biramous.

Includes only one order, the Nebaliacea, with *Nebalia* (Fig. 464) and three allied genera.

Series II.—Eumalacostraca.

Malacostraca with six segments and a telson in the abdomen, the latter never provided with caudal styles. Carapace never bivalve. Thoracic appendages nearly always leg-like, but seldom all uniform: their protopodite always made up of two podomeres except in the Stomatopoda.

Division 1.—Syncarida.

Eumalacostraca devoid of carapace, with the first thoracic segment united with the head or marked off from it by a groove. Heart elongated, tubular.

ORDER ANASPIDACEA.

Syncarida in which the thoracic appendages are provided (except the last or the last two) with exopodites, and (except the last) with a double series of lamellar epipodites (gills). The abdominal

appendages, except the first two in the male and the last in both sexes, have the endopodite reduced or absent. The last pair of abdominal appendages (uropods) expanded, and forming with the telson a fan-like tail-fin. This, the only order of the Syncarida, comprises the genera *Anaspides*, *Koonunga*, and *Paranaspides* (Fig. 465). A related form is *Bathynella*, which, however, has only one pair of abdominal appendages and no tail-fin.

Division 2.—Peracarida.

Eumalacostraca in which the carapace, when present, leaves at least four of the thoracic segments free. Heart elongated, tubular.

ORDER 1.—MYSIDACEA.

Peracarida in which, though the carapace extends over the greater part of the thorax, it does not coalesce dorsally with more than the first three segments. The eyes, when present, are supported on movable stalks; the antennules are biramous, and the antennæ have a scale-like exopodite or squame. The first pair of thoracic appendages are specialised as maxillipedes. The thoracic appendages (except sometimes the first and second pairs) are biramous. The uropods with the telson form a broad fan-like tail-fin.

This order includes *Mysis* (Fig. 466), *Lophogaster*, and other genera.

ORDER 2.—CUMACEA.

Peracarida in which the carapace coalesces with the first three or four segments of the thorax, is produced on each side to enclose a branchial cavity, and in front is drawn out into a rostrum. The eyes usually coalesce into one, which is not borne on a movable stalk. The antennules are sometimes biramous; the antennæ have no exopodites. Some of the thoracic appendages are biramous. The telson may coalesce with the last segment of the abdomen. The uropods are styliform, and there is no fan-like tail-fin.

Includes *Cuma* (*Bodotria*), *Diastylis*, etc. (Fig. 467).

ORDER 3.—TANAIDACEA.

Peracarida in which the carapace coalesces with the first two thoracic segments and is produced on each side to enclose a branchial cavity. The eyes, when present, are usually supported on short stalks which are not movable. The antennules are sometimes biramous: the antennæ may possess small exopodites. The first pair of thoracic limbs are modified as maxillipedes. The second and third thoracic limbs sometimes have vestigial exopodites. The uropods are usually narrow.

This order includes *Apseudes*, *Tanais*, *Leptochelia*, etc.

ORDER 4.—ISOPODA.

Peracarida in which the dorsal exoskeleton of the head is not produced into a carapace, but in which the first and sometimes also the second segment of the thorax coalesce with the head. The eyes are sessile or borne on short processes which are not movable. The antennules are nearly always uniramous: the antennæ sometimes bear a minute exopodite. The thoracic limbs have no exopodites: the first pair are modified as maxillipedes; the rest are usually alike in character. The abdominal appendages are usually biramous; the rami function as branchiæ. The body is nearly always dorso-ventrally compressed. This is a large order including many families, *e.g.*—*Asellus*, *Phreatoicus*, *Anthura*, *Sphaeroma*, *Idotea*, *Oniscus*, *Bopyrus* (Figs. 469, 471).

ORDER 5.—AMPHIPODA.

Peracarida with the characters of the preceding order, except that (1) the body is nearly always laterally compressed; (2) the second and third pairs of thoracic appendages are nearly always modified as prehensile organs (gnathopods); (3) there are vesicular or lamellar branchiæ attached to the bases of more or fewer of the thoracic limbs; (4) the abdominal appendages are distinguishable into two sets, the three anterior pairs with many-jointed rami, the three posterior (including the uropods) with unjointed styliform rami.

Includes *Orchestia*, *Gammarus* (Fig. 468), *Hyperia*, *Caprella*, *Cyamus* (Fig. 470), and many other genera.

Division 3.—Eucarida.

Malacostraca in which the carapace coalesces with all the thoracic segments, forming a cephalothorax. The eyes are borne on movable stalks. The heart is short, sac-like, and situated in the thorax.

ORDER 1.—EUPHAUSIACEA.

Eucarida in which none of the thoracic limbs take the form of maxillipedes: with a single series of branchiæ (podobranchs) attached to the bases of the thoracic limbs. The larva is a nauplius.

This is a comparatively small order of pelagic Malacostraca, including *Euphausia* (Fig. 479), *Thysanopoda*, *Nyctiphanes*, and a few other genera.

ORDER 2.—DECAPODA.

Eucarida in which the first three pairs of thoracic appendages are modified as maxillipedes, with the branchiæ usually in several series—podobranchs, arthrobranchs, and pleurobranchs.

Sub-order 1.—Macrura.

Decapoda with well-developed, elongated abdomen, which is usually held in the extended position, and terminates in an expanded fan-like tail-fin composed of the telson and the uropods. The eyes are not enclosed in orbits. The antennules and antennæ are both large; the former are not sunk in pits, and the antennæ usually have a scale-like exopodite (squame).

Included among the Macrura are (a) swimming forms—*Penæus* and *Palæmon* (Prawns), *Crangon* (Shrimps), *Lucifer*, etc.; and (b) creeping forms—*Homarus* (Lobster), *Astacus*, *Astacopsis*, *Paranephrops*, *Cambarus* (Fresh-water Crayfishes), *Palinurus* (Rocklobsters), *Scyllarus*, etc. (Figs. 472, 473).

Sub-order 2.—Anomura.

Decapoda with the abdomen more or less reduced, usually held in a flexed position, and not provided with such a well-developed tail-fin as in the Macrura.

In most respects the Anomura are intermediate between the Macrura and the Brachyura. Examples are the Hermit-crabs—*Pagurus* (Fig. 474) and other genera, the Cocoa-nut crab—*Birgus*, *Galathea*, *Hippa*, *Porcellana*, etc.

Sub-order 3.—Brachyura.

Decapoda in which the abdomen is greatly reduced, shorter than the cephalothorax, and permanently flexed beneath it. The antennules and the eyes are both capable of being retracted into cavities. There is a metamorphosis comprising *zoæa* and *megalopa* stages.

Including the true Crabs such as *Cancer*, *Maia*, *Grapsus*, etc. (Figs. 475, 476).

Division 4.—Hoplocarida.

Malacostraca in which the carapace does not coalesce with at least the last four thoracic segments, so that the cephalothorax is relatively short. In front of the head proper are two movable segments, one bearing the stalked eyes, the other the antennules. The branchiæ are borne on the abdominal appendages. The heart is elongated. There is a metamorphosis, but a nauplius stage is not known to occur.

ORDER STOMATOPODA.

This, the only order of Hoplocarida, includes *Squilla* (Fig. 477), *Gonodactylus*, and other genera.

Systematic Position of the Examples.

The genera *Apus* and *Lepidurus* belong to the family *Apodidae* of the order *Notostraca* of the sub-class *Branchiopoda*.

The foliaceous character of the swimming-feet is alone sufficient to assign them to the Branchiopoda, and the large number of segments (considerably more than ten) and swimming-feet, together with the presence of the large shield-like carapace, decides their position among the Notostraca.

They are placed in the family Apodidæ in virtue of the elongated body with 40-60 pairs of swimming-feet, diminishing in size from before backwards and showing considerable differentiation; and of the elongated heart reaching to the twelfth post-cephalic segment.

Apus is distinguished by the absence of a post-anal plate, and by elongated flagella (endites) to the first pair of thoracic feet; in *Lepidurus* the post-anal plate is present, and the flagella of the first thoracic feet are short.

Astacus fluviatilis is one of several species of the genus *Astacus*, belonging to the family *Potamobiidæ*, tribe *Astacoidea*, sub-order *Macrura*, order *Decapoda*, and sub-class *Malacostraca*.

The possession of a thorax made up of eight segments and an abdomen of six places it among the Malacostraca: the presence of a cephalothorax formed by coalescence of head and thorax, together with that of movable eye-stalks, determines its position in the division Eucarida: the modification of the first three pairs of thoracic appendages as maxillipedes, and the arrangement of the branchiæ in three sets, place it in the Decapoda.

The possession of a squame to the antenna, and of legs having all seven podomeres distinct—the first three pairs chelate, and the first pair greatly enlarged—determine its position in the tribe Astacoidea, which includes all the fresh-water Crayfishes and the true Lobsters. The family Potamobiidæ is distinguished by having the podobranchiæ partly united to the epipodites, and by possessing appendages on the first abdominal segment of the male and usually on that of the female.

3. GENERAL ORGANISATION.

There is no class in the animal kingdom which presents so wide a range of organisation as the Crustacea, or in which the deviations in structure from the "type-form" are so striking and so interesting from their obvious adaptation to the mode of life.

The most interesting modifications are those connected with the **external characters** and the **structure of the appendages**. As we have seen, the body consists of a prostomium, a variable number of metameres, and an anal segment. The first five metameres fuse with the prostomium to form a head, which, as well as the anal segment, is homologous throughout the class. On the other hand, there is no strict homology between the various post-cephalic metameres in different forms until we come to the Malacostraca, in which their number is constant.

There is considerable diversity of form among the *Branchiopoda*. *Apus* has already been described. *Branchipus* (Fig. 455, 1) and *Artemia* (the Brine-shrimp) (*Anostraca*) are small shrimp-like forms, the former living in fresh-water lakes, the latter in brine-pools; they have no carapace, and the eyes are raised on unjointed stalks. In *Limnetis* (2), on the other hand, and in *Estheria* (3) the carapace takes the form of a *shell*, formed of two parts or *valves*, united in *Estheria* by a hinge, and resembling the shell of a cockle or other bivalved mollusc. The limbs have the same general structure as those of *Apus*, but the antennæ are often of considerable size, and are sometimes modified into prehensile organs.

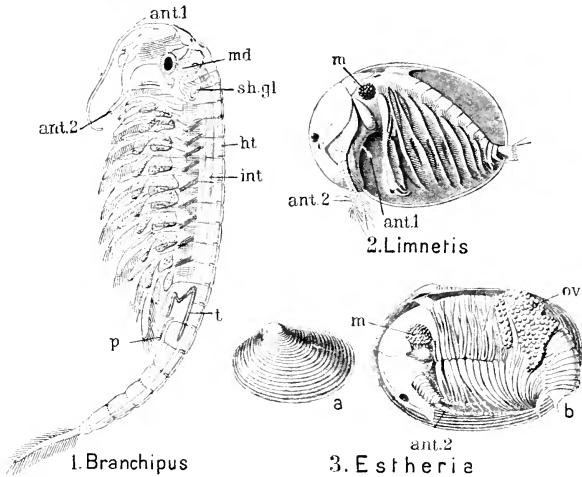

FIG. 455.—Three **Branchiopoda**. In 3, *a* is the shell; *b* the animal with one valve of the shell removed. *ant*¹, antennule; *ant*², antenna; *ht*, heart; *m*, adductor muscle; *md*, mandible; *ov*, ovary; *a*, unpaired process from head; *p*, copulatory appendages; *sh.gl*, shell-gland; *t*, testis. (After Gerstaecker.)

In the *Cladocera*, of which the common fresh-water *Daphnia* (Fig. 456, 1) is a good example, there is a great reduction in size (1–2 mm.), and a corresponding shortening of the body by a reduction in the number of metameres. Segmentation is very imperfect, and the whole body, but not the head, is covered by a large, folded carapace. The abdomen is turned downwards and is in constant movement, sweeping out any foreign particles which may have made their way among the feet. Between the abdomen of the female and the posterior part of the carapace is a large *brood-pouch* (*br.p.*), in which the eggs are stored. The

paired eyes (*E*) have fused into a single organ, which exhibits a constant trembling movement. The antennules (*ant. 1*) are small, the antennæ (*ant. 2*) very large, biramous, and constitute the chief organs of locomotion. The mandibles are large, the second maxillæ absent in the adult, and there are usually five pairs of leaf-like swimming-feet (*f*) on the thorax. The abdomen is devoid of appendages. Many of the Cladocera have an extraordinarily grotesque form (2, 3), owing to the peculiar shape of the head, the immense antennæ, and the great hump-like brood-pouch.

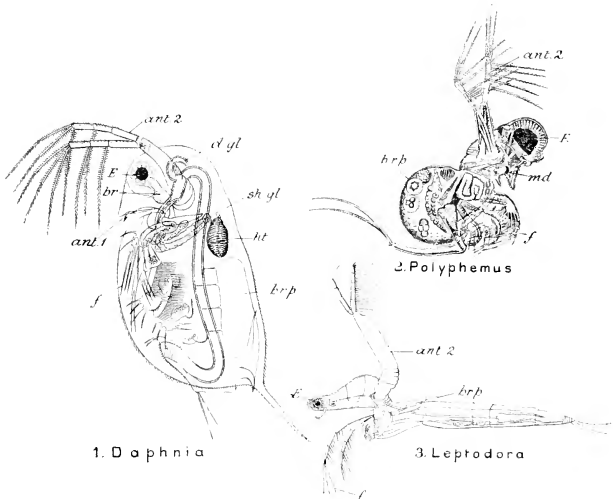

FIG. 456.—Three **Cladocera**. *ant. 1*, antennule; *ant. 2*, antenna; *br.* brain; *br. p.* brood-pouch; *E.* eye; *d. gl.* digestive gland; *f.* swimming feet; *ht.* heart; *md.* mandible; *sh. gl.* shell-gland. (1 after Claus, 2 and 3 after Gerstaecker.)

The *Ostracoda* are usually not more than 1-2 mm. in length, and are found both in fresh- and sea-water. One of the commonest genera is *Cypris*, which occurs in immense numbers in stagnant pools. *Cythere* is a common marine form.

The body (Fig. 457) is unsegmented, and is completely enclosed in a carapace (*A*), the right and left halves of which are articulated together along the dorsal edge so as to form a bivalved shell (*C*), which may be variously ornamented or sculptured. The valves are opened by the elasticity of a ligament, which passes from one to another at the hinge, and are closed by a large *adductor muscle* (*m.*), which extends transversely from valve to valve, its

insertions giving rise to markings on the shell (*A, m.*), often of systematic value.

At the anterior end is a median eye (*e*), and in some forms compound eyes are present as well. There are only seven pairs of appendages. The antennules (*ant. 1*) and antennae (*ant. 2*) are large, and the latter usually biramous. The mandible (*md.*) has a large leg-like palp and a flabellum-like offshoot. The first maxilla (*mx.1*) also bears a large plate resembling a flabellum of *Apus*. The last cephalic appendage (second maxilla, *mx.2*) is jaw-like in some forms (*Cypris*), leg-like in others (*Cythere*). The only thoracic appendages are two or four pairs of slender legs (*f.1, f.2*). The abdomen (*abd.*) is devoid of appendages, and is terminated by a pair of small caudal styles.

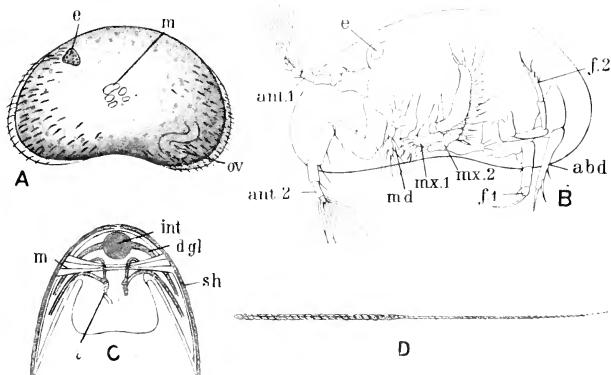

FIG. 457.—A, external view of *Cypris*; B, the same with the appendages exposed by the removal of the left valve of the shell; C, transverse section; D, a single sperm. *abd.*, abdomen; *ant.1*, antennule; *ant.2*, antenna; *d.gl.*, digestive gland; *e*, median eye; *f.1, f.2*, thoracic feet; *int.*, intestine; *m.*, adductor muscle; *md.*, mandible; *mx.1, mx.2*, maxillae; *ov.*, ovary; *sh.*, shell; *t.*, testis. (After Gerstaecker and Zenker.)

The diversity of form among the *Copepoda* is so great that it will be advisable to consider separately the *free-swimming Eucopepoda*, the *parasitic Eucopepoda*, and the *Branchiura*.

The *free-swimming Eucopepoda* are well represented by the common water-flea (*Cyclops*), found everywhere in fresh and brackish water, and easily recognisable, in spite of its minute size, by its elongated form, its rapid, jerky movements, and by the egg-sacs of the female.

Cyclops (Fig. 458, 1) has been compared in form to a split pear, the broad end being anterior, and the convex surface dorsal. The first thoracic segment is fused with the head, and the cephalothorax (*c. th.*) thus formed is covered with a carapace

produced in front into a short spine or *rostrum* (*r*), near the base of which, on the dorsal surface, is the median eye (*e*). There are five free thoracic segments: the last (*th. 6*) bears the genital aperture, and is fused in the female with the first abdominal

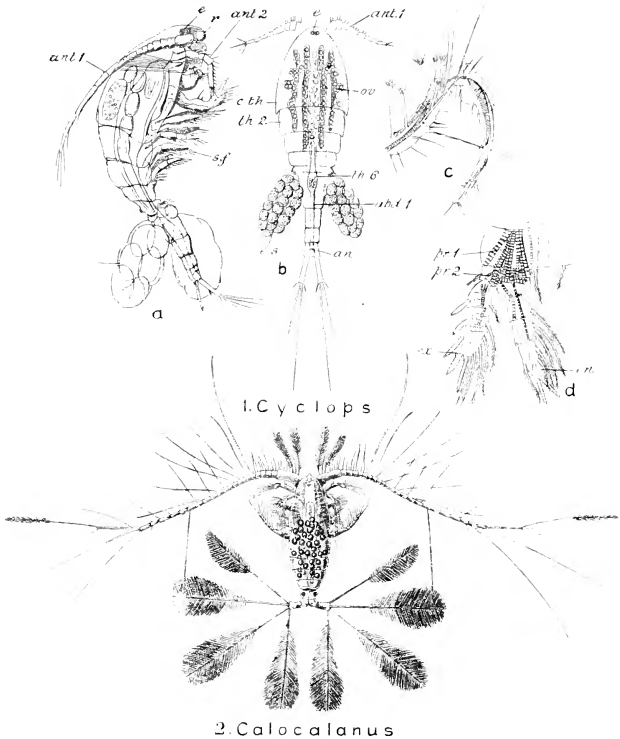

FIG. 458.—Free-swimming **Eucopepoda**. 1a, female **Cyclops**, from the right side; b, dorsal view; c, antenna of male; d, swimming-foot. *abd. 1*, first abdominal segment; *an*, anus; *ant. 1*, antennule; *ant. 2*, antenna; *c. th.*, cephalothorax; *e*, median eye; *en*, endopodite; *e. s.*, egg-sac; *ex*, exopodite; *ov*, ovary; *pr. 1*, *pr. 2*, protopodite; *r*, rostrum; *s. f.*, swimming-foot; *th. 2*, *th. 6*, thoracic segments. (After Huxley, Gerstaecker, Hartog, and Giesbrecht.)

segment (*abd. 1*). There are four abdominal segments: the last bears the dorsal anus (*an*), and a pair of caudal styles produced into plumed setae.

The antennules (*ant. 1*) are very large, and are the principal organs of locomotion. In the male they are modified (*c*)—by a

peculiar form of joint and long setae—as clasp ing organs, used for holding the female during copulation. The antennae (*ant. 2*) are comparatively short and uniramous. Mandibles and maxillae are present, and the first four thoracic segments bear biramous

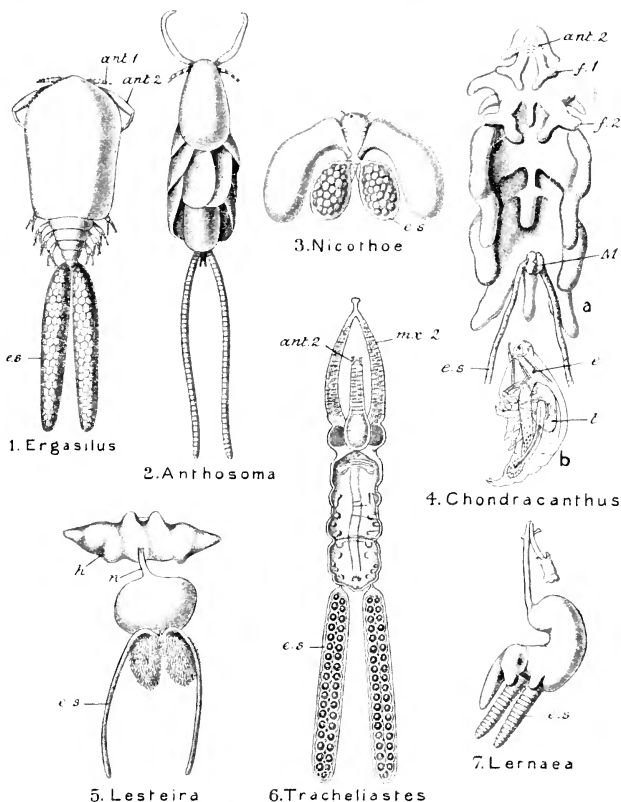

FIG. 459.—Various forms of parasitic **Eucopepoda**. 4a, female; 4b, male. *ant. 1*, antennule; *ant. 2*, antenna; *e*, median eye; *e.s.*, egg-sac; *f. 1*, *f. 2*, thoracic feet; *h*, head; *M*, male; *mx. 2*, second maxilla; *n*, "neck." (After Gerstaecker, Claus, Cuvier, and G. M. Thompson.)

swimming-feet (*1a, s.f.*), those of the right and left sides being connected by transverse plates or *couplers*. The fifth thoracic segment bears a pair of vestigial limbs: the abdominal segments are limbless.

Some of the pelagic marine Eucepoda (Fig. 458, 2) are remarkable for their brilliant colours and for the extraordinary development of their setæ, especially those of the caudal styles.

The *parasitic Eucepoda*, or Fish-lice, present a very interesting series of modifications, illustrating the degeneration of structure which so often accompanies parasitism. *Ergasilus* (Fig. 459, 1)

is found on the gills of the Bass (*Morone labrax*); it is readily recognisable as a Copepod, but the appendages are greatly reduced, the antennæ modified into hooks for holding on to the host, and the eyes absent. *Anthosoma* (2), found in the mouth of the Porbeagle Shark (*Lamna cornubica*), has recognisable appendages, but the form of the body is much modified by the development of curious overlapping lobes. *Nicthöc* (3), found on the gills of the Lobster, has antennæ and mouth-parts modified for suction: the abdomen is normal, but the thorax is produced into huge lobes, which give it a curiously deformed appearance. In *Chondracanthus* (4), the various species of which are parasites on the gills of Bony Fishes, there is, at the first glance, nothing to suggest that the animal is a Crustacean, except the characteristic copepod egg-sacs: the body is depressed, unsegmented, and produced into crinkled lobes, and it requires careful examination to discover that antennules, hooked antennæ (*ant.2*)—used for attachment—mandibles, maxillæ, and two pairs of legs (*f.1, f.2*) are present. The male (*b*) is of higher organisation than the female, but of minute size—about $\frac{1}{12}$ the length of its mate—and is permanently attached to her body,

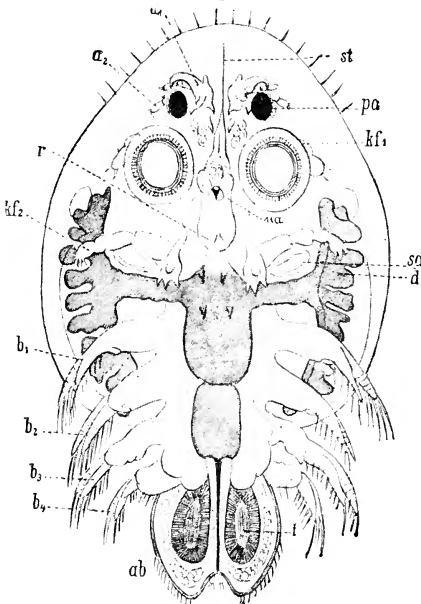

FIG. 460.—*Argulus foliaceus*, young male. *a*₁, antennule; *a*₂, antenna; *ab*, abdomen; *b*₁–*b*₄, thoracic feet; *d*, digestive glands connected with intestine; *kf1*, anterior or suctional feet; *kf2*, posterior or leg-like portion of second maxillæ; *pa*, paired eye; *r*, rostrum; *sd*, shell-gland; *st*, stylet; *ts*, testis; *ua*, median eye. (From Lang's *Comparative Anatomy*.)

Chondracanthus (4), the various species of which are parasites on the gills of Bony Fishes, there is, at the first glance, nothing to suggest that the animal is a Crustacean, except the characteristic copepod egg-sacs: the body is depressed, unsegmented, and produced into crinkled lobes, and it requires careful examination to discover that antennules, hooked antennæ (*ant.2*)—used for attachment—mandibles, maxillæ, and two pairs of legs (*f.1, f.2*) are present. The male (*b*) is of higher organisation than the female, but of minute size—about $\frac{1}{12}$ the length of its mate—and is permanently attached to her body,

close to the genital aperture (*a*, *M*). In *Lernæa* (7) and its allies the body is vermiform with a curiously lobed anterior end: the maxillæ are adapted for piercing the skin of the host and sucking its juices, and there are minute vestiges of feet. In *Lesteira* (5) the degradation is even more marked: the female reaches a large size—70 mm. in length, excluding the egg-sacs—and is found with the swollen head between the skin and flesh of a fish (*Genypterus blacodes*), and the rest of the body hanging freely into the water. Lastly, in *Tracheliastes* (6) the second maxillæ (*mx.2*) are greatly enlarged, and form a characteristic organ of attachment.

Argulus (Fig. 460) is the most familiar example of the *Branchiura*, or Carp-lice. It is an external parasite on fresh-water Fishes (Carp, Stickleback, &c.), not permanently attached like the degenerate forms just described, but crawling freely over the surface of the host. The body consists of an oval flattened cephalothorax, and a small bilobed abdomen (*ab.*). The mandibles and maxillæ are piercing organs enclosed in a sucking-tube or proboscis (*r.*), in front of which is a median tube ending in a spine (*st.*). The second maxillæ are divided into two portions, the anterior of which (*lf. I*) are modified into sucking-discs by which the parasite clings to the surface of its host, and there are four pairs of swimming-feet (*b.*—*b.*₄). Alone among the Copepoda the Branchiura have no egg-sacs, and they are exceptional also in the possession of compound eyes (*pa.*).

The most familiar examples of the *Eucirripedia* are the Barnacles found on ships' bottoms, piles, &c., and the Acorn-shells or Sessile Barnacles which occur in immense numbers on rocks between tide-marks in all parts of the world.

The common Barnacle (*Lepas anatifera*) is attached by a long stalk or peduncle (Fig. 461, *A*, *p*), covered with a wrinkled skin, and bearing at its distal end the body proper enclosed in a sort of bivalved carapace, formed by a fold of the skin, and strengthened by five calcareous plates. Of these one is median and dorsal, and is called the *carina* (*c*); two are lateral and proximal, the *scuta* (*s*); and two lateral and distal, the *terga* (*t*). During life the carapace is partly open, and from the ventrally placed aperture delicate setose filaments are protruded and keep up a constant grasping movement: these are the endo- and exopodites of the biramous thoracic feet, of which there are six pairs. Removal of the carapace shows the feet to arise from a vermiform unsegmented body (*B*), attached on the ventral aspect to the stalk and carapace by its anterior end, while its posterior end is free and terminates in a long filament, the penis (*p*), immediately dorsal to which is the anus. The mouth is ventral and anterior, and is provided with a pair of mandibles and two pairs of maxillæ. There are no antennæ; at first sight the antennules appear to be absent, but a careful examination shows the presence of a pair of minute structures (*a'*) on the proximal or attached surface of the stalk, and embedded in the cement by which the animal is fixed to its

support; these are the antennules, and their position relatively to the mandibles shows that the stalk is formed by an elongation of the anterior region of the head.

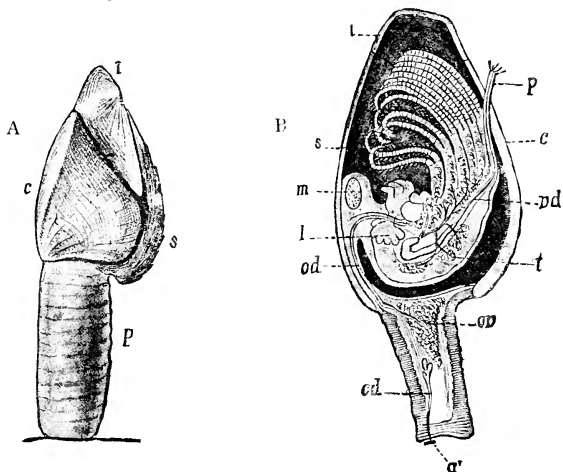

FIG. 461.—*Lepas anatifera*. *A*, the entire animal; *B*, anatomy. a_1 , antennule; *c*, carina; *cd*, cement-gland; *l*, digestive gland; *m*, adductor muscle; *od*, oviduct; *ov*, ovary; *p*, (in *B*) penis and (in *A*) peduncle; *s*, scutum; *t*, tergum and testis; *vd*, vas deferens. (From Lang's *Comparative Anatomy*, after Darwin and Claus.)

The Sessile Barnacles or Acorn-shells (*Balanus*) have no stalk (Fig. 462), the head-region being short and broad. The scuta (*s*)

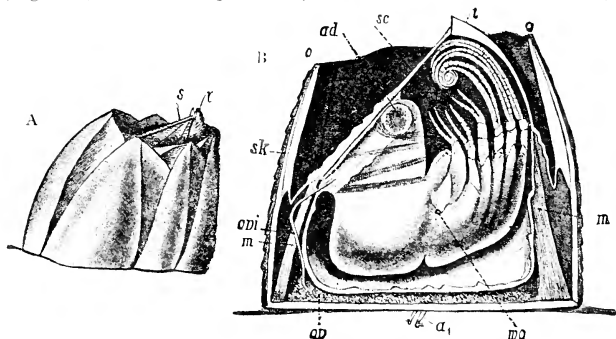

FIG. 462.—*Balanus*. *A*, external view; *B*, anatomy. a_1 , antennules; *ad*, adductor muscle; *m*, muscles of scuta and terga; *o*, edge of parapet; *ov*, ovary; *ovi*, oviduct; *s*, scutum; *sk*, parapet; *t*, tergum; *wo*, female aperture. (From Lang's *Comparative Anatomy*, after Darwin.)

and terga (*t*) support a valvular carapace, through the opening of which the feet are protruded, and the whole animal is surrounded by a sort of parapet (*sk*) formed of six calcareous pieces. One of these, dorsal in position, is the carina, the others appear to be represented by small calcifications developed on the peduncle of certain stalked forms such as *Pollicipes*.

Many of the Eucirripedia are parasitic. Some of these (*Petrarca*, &c.), parasitic in Actinozoa, resemble the attached forms in essential respects; others (*Alcippe*), parasitic in the shells of Molluscs and Cirripedes, have abdominal but no thoracic feet. *Proteolepas*, also parasitic on other Cirripedes, has a maggot-like, segmented, limbless body, and a suctorial mouth.

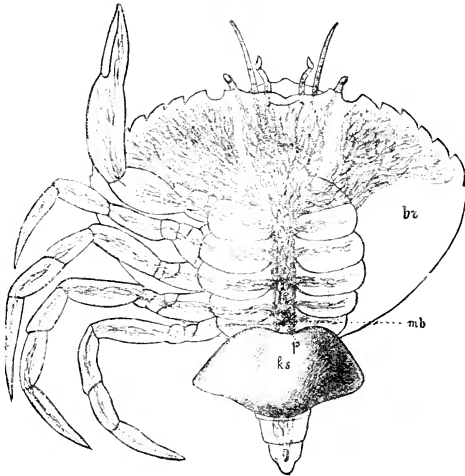

FIG. 463.—*Sacculina carcini*, on abdomen of crab. *br*, branchial region of crab; *t*, hepatic region; *d*, intestinal region; *ks*, body of parasite; *p*, peduncle; *mb*, basilar membrane, giving off root-like processes which are seen extending through the body of the host. (From Lang's *Comparative Anatomy*, after Delage.)

The *Rhizocephala* are represented by *Sacculina* (Fig. 463), parasitic on Crabs, and *Peltogaster* on Hermit-Crabs. Both genera have the appearance of an immense tumour (*ks*) on the abdomen of the host, showing no sign of segmentation, no appendages, no mouth or anus. From the attached end go off a number of delicate root-like filaments, which extend through the body of the host and absorb nutriment. Obviously degeneration is here as complete as it can well be, and nothing but the developmental history of the parasite (p. 583) would justify its inclusion among the Crustacea.

The most striking general character in the external features of the *Malacostraca* is the limitation in the number of segments. The head has the same composition as in the Entomostraca, but the thorax is invariably formed of eight segments, and, except in the Phyllocarida, the abdomen of six segments and a telson. The limbs are strikingly modified for the performance of various functions.

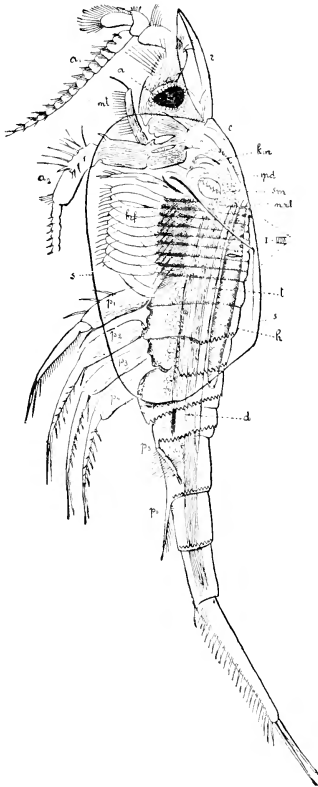

FIG. 464.—*Nebalia geoffroyi*, male. *a*, eye; *a*₁, antennule; *a*₂, antenna; *c*, head; *brf.* thoracic feet; *d*, intestine; *h*, heart; *km*, gizzard; *md.* mandible; *mt*, mandibular palp; *mxt.* exopodite of second maxilla; *p*₁–*p*₄, pleopods; *r*, rostrum; *s*, carapace; *sm*, adductor muscle; *t*, testis; I–VIII, thoracic segments. (From Lang's *Comparative Anatomy*, after Claus.)

The *Phyllocarida* are interesting from the fact that they are annectent or linking forms between the Branchiopoda and the Copepoda on the one hand, and the higher Crustacea, particularly the Schizopoda and Decapoda, on the other. The order contains only three genera, the commonest of which, *Nebalia* (Fig. 464), is a little shrimp-like marine Crustacean about 6–8 mm. in length. The body is divisible into head, thorax, and abdomen, all having the normal malacostracan number of segments except the abdomen, which is formed of eight segments, the last bearing caudal styles—structures not found elsewhere in the subclass. There is a bivalved cephalic carapace (*s*), closed by an adductor muscle (*sm*) and extending backwards to the fourth abdominal segment: it is terminated in front by a movable rostrum (*r*).

The eyes (*a*) are large, compound, and raised on movably articulated stalks.

The antennules (*a*₁) and antennæ (*a*₂) are large, the mandibles (*md.*) have palps (*mt*), and the exopodite of the second maxilla (*mxt.*) has the form of a slender filament which acts as a "cleaning-

foot" to keep the cavity of the carapace free from foreign bodies. There are eight thoracic appendages (*brf*), all of them leaf-like, and recalling those of *Apus*. The first four abdominal appendages (p_1-p_4) are large biramous swimming-feet, like those of Copepods; the fifth and sixth (p_5, p_6) are small and uniramous.

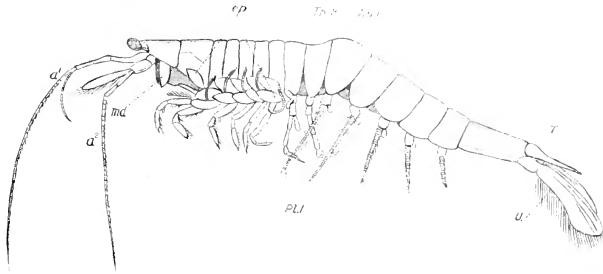

FIG. 465.—**Paranaspides lacustris**, ♀. *a*¹, antennules; *a*², antenna; *Ab. 1*, first abdominal segment; *ep*, epipodites or gills on the thoracic legs; *md*, mandible; *PL. 1*, first abdominal appendage; *T*, telson; *Th. 8*, eighth free thoracic segment; *U*, uropod. (After Geoffrey Smith.)

The Syncarida (*Anaspidacea*) (Fig. 465) are small, shrimp-like, fresh-water Crustaceans, which, though resembling the rest of the Malacostraca (Eumalacostraca) in the presence of only six segments in the abdomen and the absence of caudal styles, differ from them in

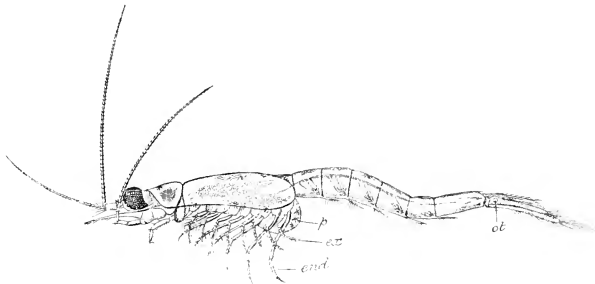

FIG. 466.—**Mysis oculata**. *end*, endopodite; *ex*, exopodite; *ot*, otcyst; *p*, brood-pouch. (After Gerstaecker.)

the possession of a combination of features which connect them more closely with certain fossil forms of Carboniferous age. Thus there is no carapace, the thoracic appendages are provided with slender respiratory exopodites, and bear a double series of epipodites or

branchiæ; there are stalked eyes and a fan-like tail-fin formed of the telson and the expanded uropods.

The *Mysidacea* (Fig. 466) are small, transparent, shrimp-like forms, mostly from 2—6 mm. in length. They agree with the Crayfish in the general form of the body, in the union of the head and thorax, in the presence of a carapace—which leaves some of the posterior thoracic segments free—and in the number both of segments and appendages, but present several interesting characters indicating a lower grade of organisation. One of the most notable of these is the absence of differentiation in the thoracic appendages, which, though they have a leg-like and not a leaf-like form, are all alike, none of them being modified into maxillipedes, except to a very slight degree in some forms. Moreover, the legs all possess exopodites (*ex*), thus retaining the primitive biramous or “split-footed” form which is lost in the Decapoda. The first five pleopods are large in the male, small in the female: the sixth is a uropod, *i.e.*, assists the telson in the formation of the characteristic malacostracan tail-fin: there is no trace of the entomostracan caudal styles.

The *Cumacea* are also a very small group: *Diastylis* (Fig. 467) is a good example. They are little shrimp-like animals, differing from all the Malacostraca previously considered in having poorly developed sessile eyes, sometimes fused together, and in some genera altogether absent. The carapace (*cth*) is so small as to leave the five posterior segments (*th IV—VIII*) uncovered. The first two pairs of thoracic limbs are maxillipedes, the last six legs: of these two or three pairs have exopodites (*ex*).

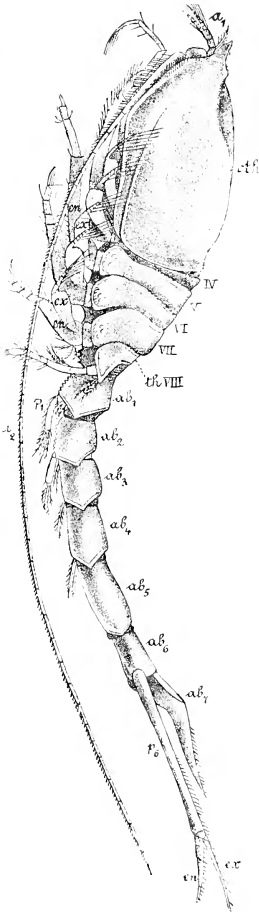

FIG. 467.—*Diastylis stygia*. *a*₁, antennule; *a*₂, antenna; *ab*₁—*ab*₇, abdominal segments; *cth*, cephalothorax; *en*, endopodite; *ex*, exopodite; *p*₁, *p*₂, *p*₃, *p*₄, *p*₅, *p*₆, pleopods; *th IV*, *th VII*, *th VIII*, free thoracic segments. (From Lang's *Comparative Anatomy*, after Sars.)

The *Tanaidacea*, the *Isopoda*, and the *Amphipoda* are often grouped together under the heading of *Arthrostraci*. These orders, particularly the two last, comprise a great number of genera and species, many of them strangely modified in correspondence with special habits of life. The best known examples of the *Amphipoda* are the little Fresh-water Shrimp (*Gammarus*, Fig. 468) and the Sandhoppers (*Talitrus*, *Orchestia*) so common on the sea-shore. Of the *Isopoda* very convenient examples are *Asellus* (Fig. 469), common in fresh-water, and the well-known Wood-lice or Slaters (*Oniscus*, Fig. 471, 1), found under almost any piece of wood, stone, &c., which has lain undisturbed on the ground for a few weeks.

The body is usually compressed or flattened from side to side in

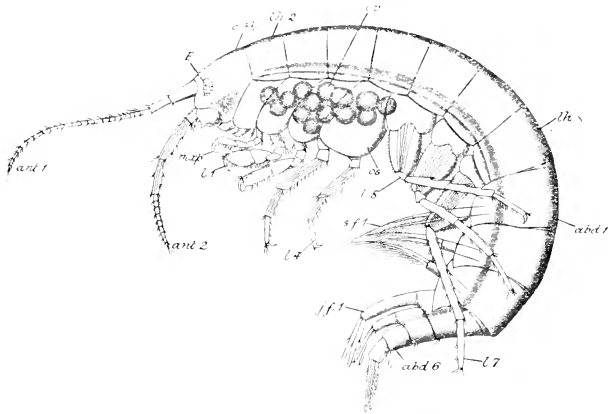

FIG. 468.—*Gammarus neglectus*. *abd. 1—abd. 6*, abdominal segments; *ant. 1*, antennule; *ant. 2*, antenna; *cth.*, cephalothorax; *E.*, eye; *j. f. 1*, first jumping-foot; *l. 1—l. 7*, legs; *m. xp.*, maxillipede; *os.*, oostegite; *ov.*, ova; *s. f. 1*, first swimming-foot; *th. 2—th. 8*, free thoracic segments. (After Gerstaecker.)

Amphipods (Fig. 468), depressed or flattened from above downwards in Isopods (Fig. 469). The normal malacostracan number of segments is present, but the first thoracic segment is always united with the head, so that the apparent head is really an incomplete or partial cephalothorax (*c.th.*). In the Tanaidacea (*Tanais*, &c.) the second segment of the thorax also unites with the head, and such forms—sometimes included under a distinct sub-order, *Anisopoda*—form a transition to the other Malacostraca, and especially the Cumacea. In the Amphipoda and Isopoda the posterior seven thoracic segments (*th. 2—th. 8*) are free, and those of the short abdomen are usually free in Amphipods (Fig. 468, *abd. 1—6*), often more or less fused in Isopods (Fig. 469, *abd.*). In some

Isopoda the thoracic segments are produced laterally into large and prominent pleura.

The eyes (*E*) are compound and usually sessile: they are, however, stalked in some of the less specialised members of the order, a circumstance which lends support to the view that the sessile eyes have, in this particular group, arisen by the atrophy of eye-stalks. The antennæ (*ant.2*) as well as the antennules (*ant.1*) are uniramous, or the former bear a minute exopodite. The first pair of thoracic appendages (*mxp*) are modified to form maxillipedes,

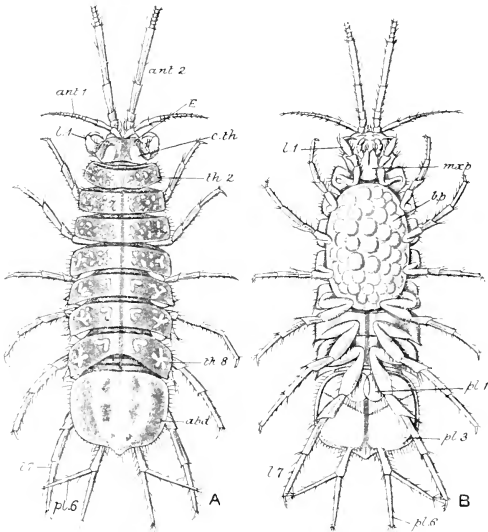

FIG. 469.—*Asellus aquaticus*. *A*, dorsal; *B*, ventral view. *abd.*, abdomen; *ant.1*, antennule; *ant.2*, antenna; *lb*, brood-pouch; *c.th.*, cephalothorax; *E*, eye; *l.1*—*l.7*, legs; *pl.1*—*pl.6*, pleopods; *th.2*—*th.8*, free thoracic segments. (After Gerstaecker.)

which are sometimes united together in the middle line so as to form a sort of lower lip. The remaining seven thoracic appendages take the form of legs (*l.1*—*l.7*) which are usually arranged in two groups, four of them directed forwards and three backwards, or *vice versa*. The legs end either in simple claws or in large subchelæ (p. 578): vestigial exopodites are present in some Tanaidacea. In the female, certain of the legs bear flat plates, the *oostegites* (Fig. 468, *os*), probably modified epipodites, which enclose a brood-pouch for the reception of the eggs. In Amphipods the gills are also borne on the legs.

The abdominal appendages are very different in the two orders. In Amphipoda the first three are biramous swimming-feet (Fig. 468, *s.f.*), the last three peculiar stiff processes used for jumping (*j.f.*). In Isopods more or fewer of the pleopods have broad plate-like endo- and exopodites (Fig. 469, *pl.3*), the former thin and vascular and acting as gills: the sixth pair (*pl.6*) are either leg-like or aid in the formation of a tail-fin.

Interesting modifications occur in both sub-orders. Among the Amphipoda, *Phronima* (Fig. 470, 1) is a marine form of glassy

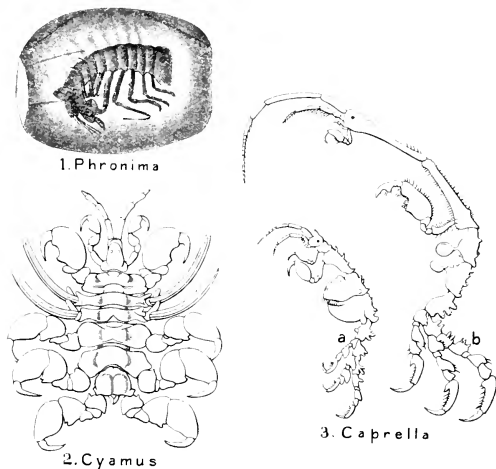

FIG. 470.—**Amphipoda.** 3, *a*, male; *b*, female. (After Gerstaecker, and Bate and Westwood.)

transparency, the female of which inhabits a transparent barrel-like structure—the test of a pelagic Tunicate—in which she brings up her young. *Caprella* (3) is a singular creature in which the abdomen is quite vestigial, and the rest of the body, as well as the appendages, extremely slender. It creeps about on colonies of Hydrozoa and Polyzoa, to the branches of which its own form and colour are so closely assimilated as to render it difficult of detection. The allied *Cyamus* (Whale-louse) (2) is parasitic on the skin of whales: it also has a vestigial abdomen, but the body—exceptionally among Amphipods—is broad and depressed, and the legs are curiously swollen.

Among the Isopoda, one of the most interesting forms is the common Wood-louse (Fig. 471, 1), which is almost unique among Crustacea for its perfect adaptation to terrestrial life. The allied

“ Pill-bugs ” (*Armadillidium*, 2) have the habit of rolling themselves up into a ball when disturbed. *Cymothoa* and its allies are large species (6–8 cm. in length) parasitic in the mouths of Fishes, where they hold on to the mucous membrane with their short, clawed legs: their mouth-parts are often modified for sucking. In the *Bopyrini*, found in the gill-cavities of various Crustacea, parasitism is accompanied by great degeneration and asymmetry, as well as by a notable degree of sexual dimorphism, the males (3 *b, m*) being very small and permanently attached to the bodies of the females. Lastly, in *Cryptoniscus*, parasitic on Crabs, the adult female (4 *b*) has no trace of crustacean organisation, and it is only by the study of development that its true systematic position can be guessed.

In the division Eucarida, the *Euphausiacea* (Fig. 479) are pelagic forms in which none of the thoracic appendages are modified so as to take the form of maxillipedes, and in which there is only

2. *Armadillidium*.3. *Gyge*.4. *Cryptoniscus*.

FIG. 471.—**Isopoda.** 3, *a*, entire animal; *b*, posterior end with attached male (*m*): 4, *a*, larva; *b*, adult female. (After Cuvier, Claus, and Gerstaecker.)

a single series of branchiæ (podo-branches).

Amongst the *Decapoda* are included nearly all the largest and most familiar Crustacea—the Prawns and Shrimps, Lobsters, Crayfishes, and Crabs. The cephalothorax is always completely covered

by the carapace. The three anterior pairs of thoracic appendages are modified into maxillipedes, which retain the original biramous character, but the five posterior pairs are enlarged, and form legs, which are always—except as an individual variation—devoid of exopodites in the adult.

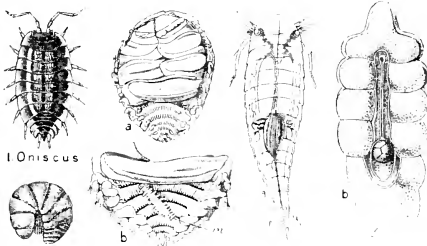
In the Shrimps and Prawns (Fig. 472) the body is compressed, and the exoskeleton is not calcified. The abdomen is very large in proportion to the cephalothorax, and has a peculiar bend close to its junction with the thorax. The legs are very slender, are used for swimming, not walking, and sometimes one pair, sometimes another, is enlarged to form the chelipeds. The rostrum is large—sometimes longer than the rest of the carapace—and the eye-stalks, antennæ, and legs may attain extraordinary dimensions.

The Lobsters and fresh-water Crayfishes agree with *Astacus* in all essential details, but the sea-Crayfishes (*Palinurus*) present some

striking modifications. There are no chelæ, the legs all ending in simple claws: the antennæ are of immense size, and their proximal segments are fused with one another and with the carapace, quite

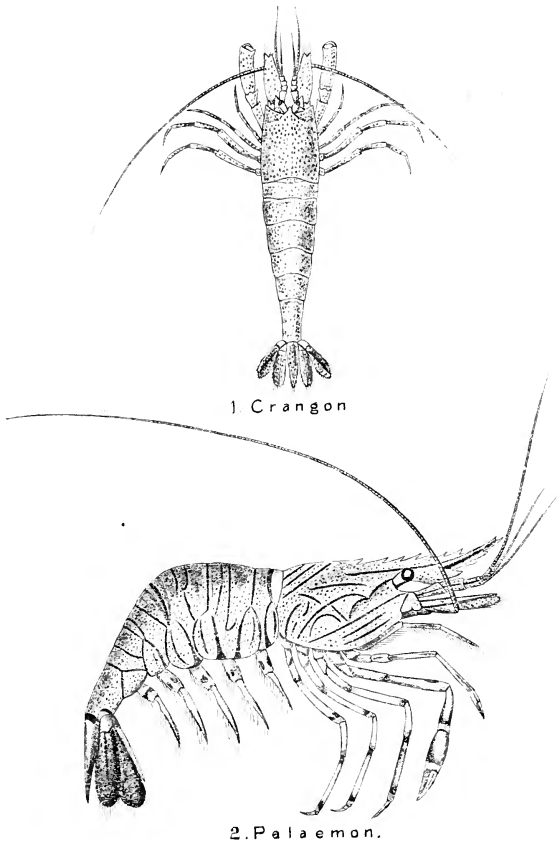

FIG. 472.—**Shrimp** (dorsal view) and **Prawn** (side view). (After Cuvier.)

crowding out the epistoma: the rostrum is reduced, or even vestigial, and the pleopods are very broad and fin-like. In *Scyllarus* (Fig. 473) and its allies the body is broad and depressed, the bases of the legs widely separated from one another by the broad

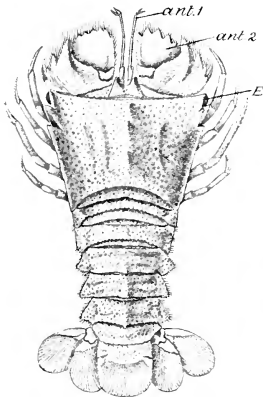

FIG. 473.—*Scyllarus arctus*.
ant. 1, antennule; ant. 2, antenna;
E, eye. (After Cuvier.)

its appendages are more or less atrophied except the sixth pair (*up*), which take the form of a pair of hooks, and are used to hold on to the columella of the shell. The fifth pair of legs (*l.5*) are much reduced, and in some species one of the chelipeds is greatly enlarged and its chela (*ch*) acts as an operculum, completely closing the mouth of the shell when the animal is retracted, or both chelipeds are enlarged to perform this function. As the Hermit-Crab grows it takes up its abode in larger and larger shells, sometimes killing and removing piecemeal the original inhabitant.

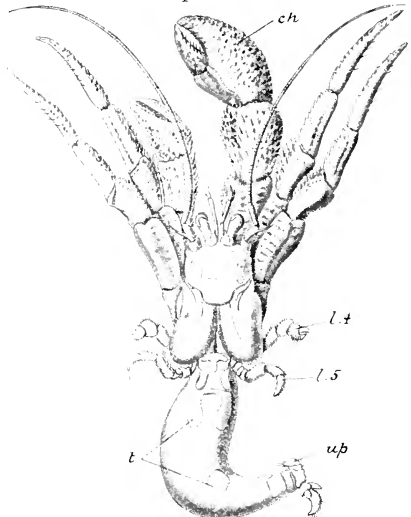

FIG. 474.—*Pagurus bernhardus*. *ch*, chela of first right leg; *l.4*, *l.5*, fourth and fifth legs; *t*, abdominal terga; *up*, uropods. (After Bell.)

sterna, the antennæ (*ant. 2*) short and plate-like, and the eye-stalks (*E*) enclosed in socket-like grooves of the carapace. Most of these characters show an approximation to what is found in the Crabs.

Of the *Anomura*, the Hermit-Crabs (*Pagurus*, &c., Fig. 474) are very strangely modified in relation with their peculiar mode of life. They are always found inhabiting the empty shells of Gastropods (Whelks, Periwinkles, &c.), the abdomen, which has become spirally twisted, completely enclosed within the shell and only the cephalothorax protruding. In correspondence with this mode of protection, the abdomen is soft, having only vestiges of terga (*t*) on the dorsal side, and

Other Anomura, such as the Cocoa-nut Crab (*Birgus*), *Hippa*, &c., approach the Brachyura in the short, more or less permanently flexed abdomen, but are clearly separated from them by the structure of the head and its appendages.

In the *Brachyura*, or true Crabs, we reach the highest degree of specialisation known among the Crustacea. The cephalothorax

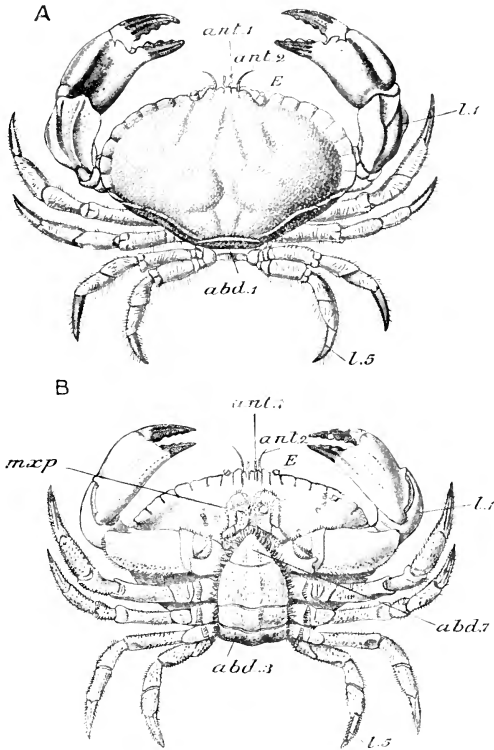

FIG. 475.—*Cancer pagurus*. A, dorsal, B, ventral aspect. *ant.1*, antennule; *ant.2*, antenna; *abd.1*, *abd.3*, *abd.7*, abdominal segments; *E*, eye-stalk; *l.1*, *l.5*, legs; *mxp.3*, third maxillipedes. (After Bell.)

(Fig. 475) is always of great proportional breadth, and is frequently much broader than long. The abdomen, on the other hand, is greatly reduced, its sternal region is uncalcified, and it lies permanently flexed in a groove on the very broad thoracic sternum, so

as to be often quite hidden in a view from above. In correspondence with this the pleopods are much reduced, the male retaining only two pairs as copulatory organs, the female four pairs for the attachment

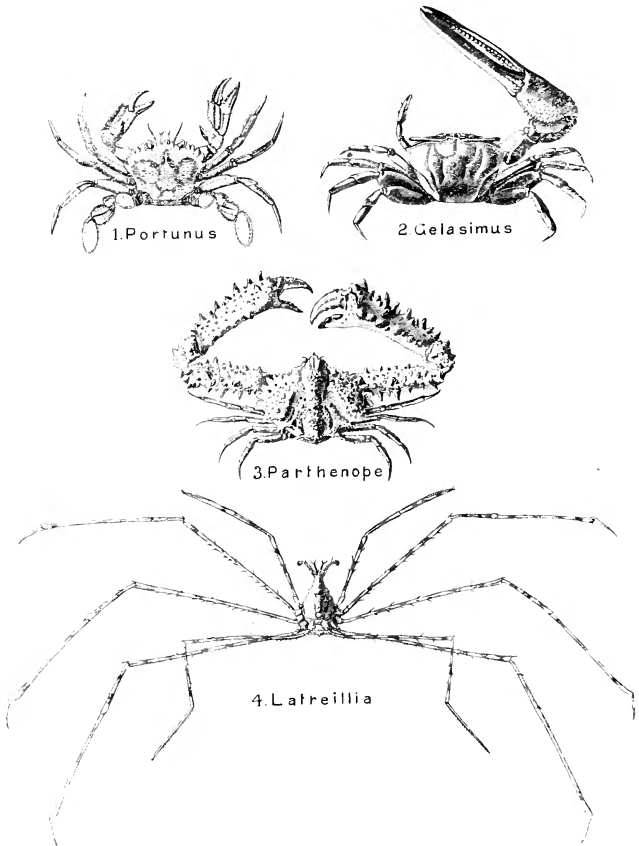

FIG. 176.—Typical **Brachyura**. (After Bell and de Haan.)

of the eggs. The uropods are absent, so that there is no tail-fin. The eye-stalks (*E*) are contained in *orbits* or sockets of the carapace, which are so prolonged that the eyes appear to arise behind the antennules and antennæ. Both pairs of feelers are small, and the

bases of the antennules are contained in sockets or *fossettes*. The third maxillipedes (*m.x.p.*) are broad, flat, and valve-like, not leg-like as in the *Macrura*. The first legs (*l.1*) form chelipeds often of great size: the remaining legs generally end in simple claws, but in the Swimming-crabs (Fig. 476, 1) the distal segment in the fifth pair is flattened and forms a fin. The range of variation in form, proportions, colour, markings, &c., among Crabs is very great (Fig. 476).

Unlike the Decapoda, the *Stomatopoda* form a very small order, comprising a few genera varying from the size of a Shrimp to that of a Lobster. *Squilla* (Fig. 477) is the best known genus.

The abdomen (a_1 — a_7) is very large in proportion to the cephalothorax, and the carapace (*cth*), which is thin and uncalcified, leaves the last three thoracic segments (*VI—VIII*) uncovered. The rostrum is movably articulated, and covers the anterior head-

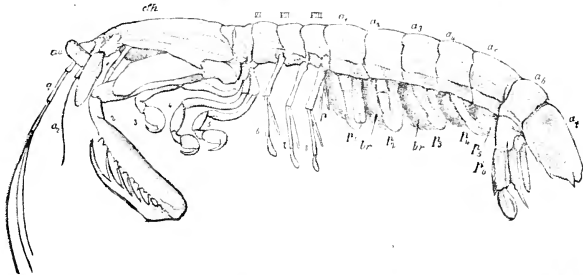

FIG. 477.—*Squilla*. a_1 , antennule; a_2 , antenna; a_1 — a_7 , abdominal segments; *br*, gills; *cth*, cephalothorax; *p*, copulatory organ; p_1 — p_3 , pleopods; p_6 , uropods; *VI—VIII*, three thoracic segments; *l*—*8*, thoracic appendages. (From Lang's *Comparative Anatomy*.)

region, which is divided into two distinct segments, the first bearing the large stalked eyes, the second the antennules. This arrangement appears to support the view that the antennulary region is a metamere distinct from the prostomium; but the division in question is absent in the larva, and does not appear till the proper segmentation of the body is established: probably it has a physiological meaning, and is connected with the necessity of extreme mobility of the eyes and olfactory organs in an animal which lives in a burrow with only the anterior end of the head exposed.

The antennule (a_1) has three flagella; the antenna (a_2) a single flagellum and a very large exopodite. The first five pairs of thoracic limbs (*l*—*5*) are turned forwards towards the mouth, and act as maxillipedes; the second of these—corresponding with the second maxillipede of *Astacus*—is very large (2), and its distal segment is turned back and articulated to the penultimate segment like the blade of a pocket-knife to the handle. In this way a very

efficient weapon called a *sub-chela* is produced, both the segments of which are produced into strong spines. The remaining three thoracic appendages (6—8) are slender legs provided with exopodites: the last of them has a styliform copulatory organ (*p*) developed from its proximal segment. The pleopods are large and biramous: the first five (p_1 — p_5) have gill-filaments (*br*) attached to their plate-like exopodites: the sixth (p_6) form large uropods or lateral tail-lobes, as in *Astacus*.

With regard to the **texture of the exoskeleton**, there is every graduation from the delicate polished cuticle of most Branchiopoda, Ostracoda, Copepoda, &c., through the calcified but still flexible cuticle of *Astacus*, to the thick, tuberculated, stony armour of many Crabs (Fig. 476, 3), or the shelly pieces of Cirripedes. The exoskeleton is secreted from a single-layered ectoderm, and undergoes periodical moults or ecdyses. There is no transverse layer of **muscle**, and the longitudinal layer is broken up into paired dorsal and ventral bands. As a rule, each limb-segment is acted upon by two muscles: the joints are nearly always hinge-joints.

The **body-cavity** consists of several chambers separated from one another by partitions. In *Palæmonetes*, one of the Prawns, there is a median dorsal chamber enclosing the ophthalmic artery, and not containing blood: it is probably a portion of the cœlome in the strict sense of the word. The cavities of the gonads are also cœlomic, and the ducts by which they communicate with the exterior are probably modified cœlomoduets. In addition to these cavities there is a large central space, in which the enteric canal, digestive glands, gonads, &c., lie; paired lateral spaces containing portions of the shell-gland; spaces in the limbs; and the pericardial sinus, in which the heart lies. All these cavities contain blood, and constitute a kind of secondary body-cavity, formed by the enlargement of blood-vessels, which have largely replaced the true cœlome. Such a secondary or blood-containing body-cavity is called a *hæmocœle*.

The **enteric canal** consists of a vertical gullet, an expanded "stomach," and a nearly straight horizontal intestine. In some of the Cladocera the intestine is coiled, but this is quite exceptional. In the lower Crustacea, part or the whole of the "stomach" is formed from the mesenteron, but in Malacostraca both gullet and "stomach" (gizzard) are developed from the stomodæum. A "gastric mill" is present in Malacostraca, and a rudiment of such an apparatus occurs in Ostracoda. The digestive glands are usually branched cæca formed as offshoots of the mesenteron: in the Isopoda and Amphipoda (Fig. 478, *l*) they are unbranched cæca extending into the abdomen: in Stomatopoda they consist of ten metamericly arranged organs opening into the intestine. In Amphipods there is an unpaired intestinal cæcum (*ud*) or a pair of cæca which may have an excretory function (*hd*). So-called

salivary glands, opening on the labrum, have been found in several genera.

In most of the Branchiopoda, Ostracoda, Copepoda, and Cirripedia, respiration takes place by the general surface of the body, and the only respiratory organs are specially modified parts of the appendages. In the stalked Barnacles, however, there are delicate processes attached to the feet, which are supposed to be rudimentary gills. Amongst the Malacostraca also, the Phyllocarida, many Mysidacea, and the Cumacea have no specialised respiratory organs, but the Euphausiacea possess tufted podobranchiæ (Fig. 479) quite uncovered by the carapace. In the Decapoda the gills may be either plume-like, as in *Astacus* and its allies, or the soft cylindrical gill-filaments may be replaced by flat plates, as in Crabs and many Prawns. It is in this order

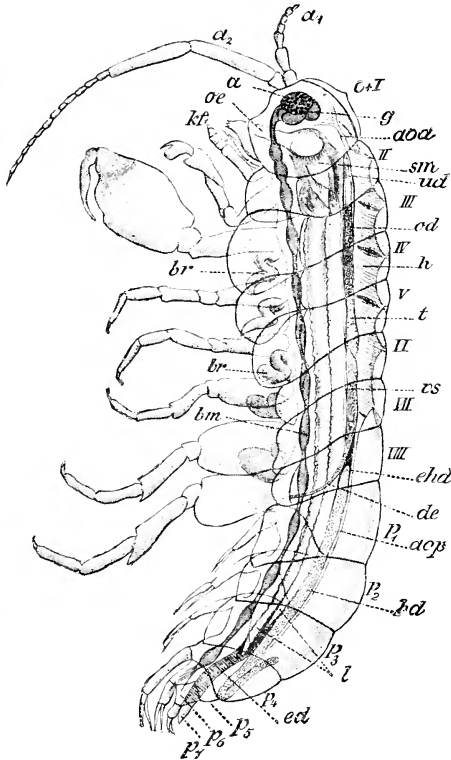

FIG. 478.—*Orchestia cavimana*, male. *a*, eye; *a*₁, antennule; *a*₂, antenna; *aea*, anterior aorta; *aop*, posterior aorta; *bm*, ventral nerve-cord; *br*, gills; *C+T*, cephalothorax; *de*, vas deferens; *cd*, rectum; *ehd*, entrance of excretory caecum into intestine; *g*, brain; *h*, heart; *hd*, excretory caecum; *kf*, maxillipede; *l*, digestive glands; *od*, anterior part of gonad in which small ova are often found in young males; *oe*, gullet; *p*₁—*p*₇, abdominal segments; *sm*, "stomach"; *ul*, intestinal caecum; *vs*, vesicula seminalis; *t*, testis; *II*—*VIII*, thoracic segments. (From Lang's *Comparative Anatomy*, after Nebesky.)

only that we find the three types of gill described in *Astacus*, and the examination of numerous forms leads to the conclusion that the typical or theoretical branchial formula for the group is as shown in the table on page 580.

Actually, however, this formula never occurs, as there is always more or less reduction in the number of gills. *Palinurus* has the highest number known, viz., twenty-one, and in the Common Crab the total number is only nine.

THORACIC SEGMENTS.	I.	II.	III.	IV.	V.	VI.	VII.	VIII.	TOTAL.
Podobranchiæ	1+cp	1+cp	1+cp	1+cp	1+cp	1+cp	1+cp	1+cp	8+8cp
Arthrobranchiæ	2	2	2	2	2	2	2	2	16
Pleurobranchiæ	1	1	1	1	1	1	1	1	8
TOTAL	4+cp	4+cp	4+cp	4+cp	4+cp	4+cp	4+cp	4+cp	32+8cp

Many Crabs live on land, and the gills are enabled to discharge their function in virtue of the moisture retained in the nearly closed gill-chamber. In the Cocoa-nut Crab (*Birgus*) the upper part of the gill-chamber is separated from the rest and forms an almost closed cavity into which vascular tufts project: it thus functions as a true lung. Probably the inner surface of the gill-cover or branchiostegite performs a respiratory function in the Crayfishes.

In Amphipoda, also, the gills (Fig. 478, *br*) are outgrowths of the thoracic limbs: in Isopods they are the modified endopodites of the second to the fifth pleopods; in some of the terrestrial

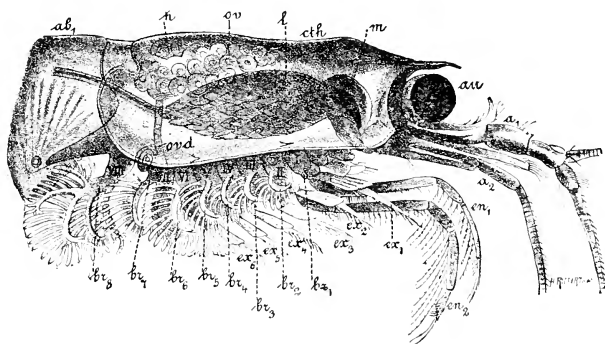

FIG. 479.—Anterior portion of *Euphausia pellucida*. *a1*, antennule; *a2*, antenna; *ab1*, first abdominal segment; *au*, eye; *br1*–*br6*, podobranchiæ; *cth*, cephalothorax; *en1*, *en2*, endopodites of first two thoracic limbs; *ex1*–*ex6*, exopodites of first six thoracic limbs; *h*, heart; *l*, digestive gland; *m*, "stomach"; *ov*, ovary; *ovd*, oviduct; *I*–*VIII*, proto-podites of thoracic limbs. (From Lang's *Comparative Anatomy*.)

forms, in adaptation to aërial respiration, a system of air-tubes is developed in the exopodites; in Stomatopoda, gill-filaments (Fig. 477, *br*) spring from the exopodites of the first to the fifth pleopods. Moreover many Crustacea perform rhythmical contractions of the intestine, taking in and expelling water: such *anal respiration* is common among the lower groups, and is especially noticeable in Cyclops.

The **heart** is absent in many Copepods (including Cyclops), in some Ostracoda (including Cypris), and in Cirripedia: it is an elongated tube with several pairs of ostia in Euphyllopoda, Leptostraca, Stomatopoda, Anaspidacea, Tanaidacea, Isopoda, and Amphipoda (Fig. 478, *h*); in Cladocera and Decapoda it is shortened to an ovoid sac with one or more pairs of ostia.

Excretory Organs.—In many larval Crustacea two pairs of modified mesonephridia are present—the *antennary glands* opening on the bases of the antennæ, and the *maxillary* or *shell-glands* opening on the bases of the second maxillæ. But as development proceeds one pair nearly always atrophies, the maxillary gland alone being usually retained in the Branchiopoda, Ostracoda, Copepoda and Cirripedia, the antennary gland in the Malacostraca. In the Stomatopoda, however, there is no antennary gland, and the function of renal excretion may be discharged by a pair of glandular tubes opening into the rectum; and in Amphipoda, though antennary glands are present, an excretory function is also assigned to a cæcum or a pair of cæca opening into the posterior end of the mesenteron. In some of the Cirripedia the maxillary gland is described as opening into one of the compartments of the body-cavity like a typical nephridium.

The **nervous system** is always formed on the ordinary arthropod type, as described in Apus and Astacus, and the chief variations it presents are connected with the greater or less amount of condescence of ganglia. In the sessile Barnacles and in the Crabs (Fig. 480) this process reaches its limit, the whole ventral nerve-cord being represented by a single immense thoracic ganglion (*bg*).

The **sense-organs** are mostly of the same character as those of the two examples. The median or nauplius-eye always occurs in the larva, and can frequently be shown to exist in the adult of even the higher groups (Decapoda). The Cirripedia and many parasitic Copepods are eyeless in the adult, as also are certain



FIG. 480.—Nervous system of a Crab (*Maia squinado*). *bg*. thoracic ganglion; *cg*. commissural ganglion; *br*. brain; *m*. gizzard; *sc*. oesophageal connective; *sg*. visceral nerves; *v*. post-oesophageal connective. (From Lang's *Comparative Anatomy*, after Milne-Edwards.)

subterranean Malacostraca. Olfactory setæ occur, as a rule, on the antennules, and the auditory organs (or statocysts) of Decapoda are open sacs in the basal segment of the same appendages, but in Mysidacea they occur as closed cysts (Fig. 466, *ot*) in the endopodites of the uropods.

Reproduction.—In most Crustacea the sexes are separate, but hermaphroditism occurs in some Branchiopods, in nearly all Cirripedes, and in certain parasitic Isopods (*Cymothoa*). In the latter case the animals are protandrous, male organs being developed first, and female organs at a later stage. In many Cirripedia minute *complemental males* are found attached, like parasites, to the body of the ordinary or hermaphrodite individual, the male organs of which appear to be inadequate for the full discharge of the fertilising function. Sexual dimorphism is almost universal, and reaches its maximum in the parasitic Copepods and Isopods already referred to.

The *gonads* are always a single pair of hollow organs discharging their products into a central cavity or lumen, whence they pass directly into the gonoducts and so to the exterior. The gonads may be simple or branched, and frequently there is more or less concrescence between those of the right and left sides, as in *Astacus* and *Cyclops*. The sperms vary greatly in form, and are usually motionless: in Cirripedia, however, they are motile, and in Ostracoda they perform movements after reaching the female ducts. In some Ostracoda they are about three times as long as the animal itself (Fig. 457, *D*). In many Branchiopoda and Ostracoda reproduction is parthenogenetic. In *Daphnia*, for instance, the animal reproduces throughout the summer by parthenogenetic *summer eggs* which develop rapidly in the brood-pouch (Fig. 456, 1, *br. p.*). In the autumn *winter eggs* are produced, which are fertilised by the males: they pass into the brood-pouch, a portion of which becomes specially modified and forms the *ephippium* or saddle. At the next moult the ephippium is detached and forms a sort of bivalved capsule in which the eggs remain in an inactive state during the winter, developing in the following spring.

Development.—In some Crustacea (*Lucifer*, *Euphausia*, and others) segmentation is complete, and a hollow blastula is formed: in others division of the nucleus into a number of daughter nuclei is followed by their migration towards the surface, where, each becoming surrounded by protoplasm, they form a layer of cells (blastoderm) enclosing a central mass of yolk (centrolecithal egg with superficial blastoderm): in others, again, the egg is telolecithal, and the protoplasm, accumulated at one pole, divides so as to form a disc of cells which afterwards spreads over the whole yolk.

Development is always accompanied by more or less metamorphosis. In most Branchiopoda the young is hatched in the form of a nauplius (Fig. 436, *A*), and further changes are of the same char-

acter as in *Apus*. In Cladocera development is direct, the nauplius-stage being passed through in the egg, and the young hatched in a form closely resembling the adult. In one of the Cladocera, however, *Leptodora* (Fig. 456, 3), while development of the summer eggs is direct, the winter eggs give rise to free nauplii. In the Ostracoda the nauplius is peculiar in having a bivalved shell and all three pairs of appendages uniramous. In all the Copepoda there is a free nauplius, which, in the parasitic forms, leads a free existence for a time, and then attaches itself to its particular host and undergoes retrograde metamorphosis.

In the Cirripedia, also, there is a free nauplius, the body of which is often produced into long spines. After several moults, the nauplius passes into a form called the *Cypris-stage* (Fig. 481), characterised by the presence of a bivalved shell, like that of an Ostracod: the antennules (*at*.¹) have become modified into organs

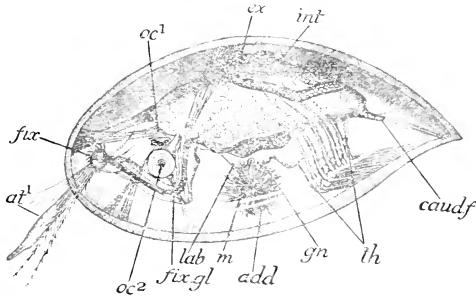

FIG. 481.—Cypris-stage of *Lepas fascicularis*. *add*, adductor muscle of carapace; *at*.¹, antennules; *caud.f.* caudal styles; *ex*, excretory organ (shell-gland); *fix*, disc for fixation; *fix. gl.* fixing gland; *gn*, jaws; *int*, intestine; *lab*, labrum; *m*, mouth; *oc*.¹, simple eye; *oc*.², compound eye; *th*, thoracic legs. (From MacBride, after Willemoes-Suhm.)

of adhesion by the development of the penultimate segment into a disc, the antennæ have disappeared, and six pairs of swimming-feet like those of a Copepod have made their appearance: there are paired compound eyes, and the shell is closed by an adductor muscle. After leading a free existence for a time, the Cypris-larva attaches itself by its antennules, aided by the secretion of cement-glands, and becomes a *pupa*: the carina, terga, and scuta appear beneath the shell, and within the skin of the mouth-parts and legs of the pupa appear the corresponding appendages of the adult. In *Lepas* the anterior region of the head grows out into a peduncle. The pupal integument is then thrown off, the paired eyes disappear, and the adult form is assumed.

In *Sacculina* a still more extraordinary metamorphosis takes place. The young is hatched as a nauplius, but without alimentary canal, and passes into a Cypris-stage. In this condition, after a

brief free existence, it attaches itself to the body of a young Crab, near the base of a seta, by means of its antennæ. The thorax with its appendages is thrown off, and the rest of the body is converted into a rounded mass of cells. The antennæ perforate the cuticle of the host, and, through the communication thus formed, the mass of cells passes into the interior of the Crab, and is carried by the movement of the blood until it comes to rest in the thorax. The Sacculina now sends out root-like processes, grows immensely, and, pressing upon the body-wall of the Crab, causes atrophy of the tissues: this allows the now greatly-swollen parasite to project on the exterior as the tumour-like adult described above (p. 565).

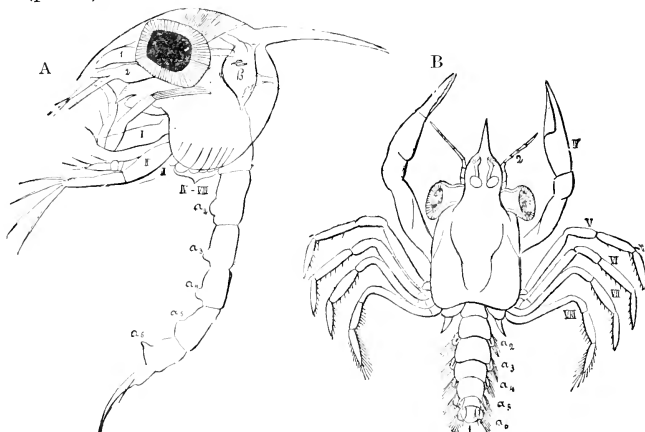

FIG. 482.—Larvæ of Crabs. *A*, Zoëa-stage of *Maia*; *B*, Megalopa-stage of *Portunus*. *h*, heart; *a*₁—*a*₆, abdominal segments; *1*, antennule; *2*, antenna; *I*—*VIII*, thoracic appendages. (From Lang's *Comparative Anatomy*, after Claus.)

The embryo of *Euphausia* leaves the egg as a typical free-swimming nauplius; this passes into what is called the *protozoëa-stage*, distinguished by the possession of an elongated, unsegmented abdomen without appendages. After successive moults, the rest of the appendages appear, and the adult form is assumed. In *Mysis* (Fig. 466) the nauplius is maggot-like, and undergoes development in the brood-pouch, emerging in a condition closely resembling the adult.

The development of the Decapoda presents a very interesting series of modifications. In two genera of prawns (*Penæus* and *Lucifer*) the embryo leaves the egg as a nauplius, and passes by successive moults through a protozoëa stage, a zoëa-stage, with segmented but limbless abdomen, and a *mysis* or *schizopod-stage*

in which it resembles an adult Mysis, having exopodites to all the thoracic limbs.

In the Crabs the nauplius stage is passed through in the egg, and the young is hatched in the form of a peculiarly modified zoëa (Fig. 482, *A*), with an immense cephalothorax produced into spines, large stalked eyes, and a slender abdomen. This passes by successive moults into the *megalopa-stage* (*B*), which resembles an adult Macruran, having an extended abdomen with well-developed pleopods. The megalopa passes by successive moults into the adult form.

In the Lobster (*Homarus*) both nauplius and zoëa-stages are passed through in the egg, and the embryo is hatched in the mysis-stage with exopodites to all the thoracic limbs. In the Rock-lobster (*Palinurus*), and its allies, the newly hatched young is a strangely modified mysis-form called a Glass-Crab or *Phyllosoma*: it has broad, depressed cephalic and thoracic shields of glassy transparency: the abdomen is very small and the legs extremely long and biramous. Lastly, in the Fresh-water Crayfish the young resemble the adult in all but proportions and certain unimportant details of structure. Thus in the series of Decapoda we get a gradual abbreviation in development, stages which are free larval forms in the lower types being hurried through before hatching in the higher.

The larvæ of Stomatopoda are grotesque little creatures with a very large spiny carapace. In Amphipoda there is no free larval form, but in Isopoda the young leave the egg in the form of a curious maggot-like modification of the nauplius, which remains in the brood-pouch until it has attained the adult form.

Ethology.—The Crustacea are remarkable for their very perfect adaptation to the most various conditions of life: they occur in fresh-water, in the sea, in brine-pools, in subterranean caves, and on land: of the marine forms some are littoral, some pelagic, some abyssal, descending to over 3,000 fathoms. One species of Copepod, *Pontellina mediterranea*, may almost be considered as aerial: it is described as taking long flying leaps out of the water, after the manner of a Flying-fish. Some, like Lobsters, Crayfishes, &c., are solitary; others, like Shrimps, are gregarious, occurring in immense shoals. Most of them either prey on living animals or devour carrion, but, as we have seen, the Barnacles are fixed, and feed on minute particles after the fashion of many of the lower animals, and the members of more than one order are parasites remarkable for their deviation from the typical structure of the class and their adaptation to their peculiar mode of life. In size they present almost every gradation from microscopic Water-fleas to Crabs two feet across the carapace, or four feet from tip to tip of the legs.

As to geographical distribution, all the chief groups are cosmopolitan, and it is only among the families, genera, and species that matters of interest from this point of view are met with. Fossil remains are known from very ancient periods. The oldest forms are usually referred to the Phyllocarida, and occur from the Cambrian to the Trias. The shells of Ostracoda are also known from the Cambrian upwards, and those of Cirripedia from the Silurian. Peracarida are known from Palæozoic times, but are rare as fossils: the earliest Macruran is a shrimp-like form from the Devonian, while the highly differentiated Brachyura are not known with absolute certainty until the Cretaceous period.

It was in the Crustacea that the recapitulation theory so often alluded to was first worked out in detail. Embryology shows that all Crustacea may be traced back in individual development to the nauplius, upon which follows some kind of zoæa-stage, many of the lower forms progressing no further. But in Malacostraca the zoæa is followed by the mysis stage, which is permanent in Schizopods, transient in Decapods. It was certainly a tempting hypothesis that this series of forms represented as many ancestral stages in the evolution of the class. But we have to remember that all such free larvæ are subject to the action of the struggle for existence, and have no doubt been modified in accordance with their own special needs and without exclusive reference to their ancestors or to the adult species into which they finally change.

Many Crustacea present instances of *protective* and *aggressive characters*, *i.e.*, modifications in form, colour, &c., which serve to conceal them from their enemies or from their prey. Probably the most striking example is that of certain crabs (*Paramithrax*), which deliberately plant Sea-weeds, Sponges, Alcyonarians, Zoo-phytes, &c., all over the carapace, and are thus perfectly concealed except when in motion. Another Crab, a species of *Dromia*, carries a relatively immense Ascidian or Sea-squirt on its back, and in another member of the same family the hinder legs are used to hold umbrella-wise over the back a single valve of a bivalve shell.

Several instances of *commensalism* occur in the class. The association of Hermit-crabs with sea-anemones, has already been referred to (p. 205): another interesting example is the occurrence of the little Pea-crab (*Pinnotheres*) in the mantle-cavity of Mussels. Other Decapods are found in the intestines of Sea-urchins and Holothurians, and one genus of Crab lives in a cavity in a Coral, the aperture being only just sufficient to allow of a due supply of food and water.

It is in Crustacea that we find the first indication of characters the purpose of which appears to be their attractiveness to the opposite sex. The immensely enlarged and highly coloured chelæ of some male crabs (*Gelasimus*, Fig. 476, 2) are said to be used for attracting the female as well as for fighting. The sound-producing

organs of some Decapoda have probably also a sexual significance. The Rock-lobster (*Palinurus vulgaris*) has a soft chitinous pad on the antenna, which it rubs against a projecting keel on the sternal region of the head, producing a peculiar creaking sound; and *Alpheus*, another Macruran, makes noises by clapping together the fixed and movable fingers of its large chele. The fact that these sounds can be produced at the will of the animals seems to show that the latter undoubtedly possess a sense of hearing, and that the auditory sac is not merely an organ of the sense of direction.

Affinities and Mutual Relationships.—That the Crustacea belong to the same general type of organisation as the articulated worms is clear enough. The advance in structure is shown in the reduction in number and in the differentiation of the segments, and in the conerescence of those at the anterior end to form a head; in the hardening of the cuticle into sclerites so as to form a jointed armour; in the jointing and mobility of the limbs; and in the differentiation of the dorsal vessel into a heart by which the propulsion of the blood is alone performed. The resemblance of the foliaceous limbs of Phyllopods to the parapodia of the higher worms is so striking that one can hardly believe it to be without significance. On the other hand, the absence of transverse muscles and of cilia, and the replacement of the coelome by blood-spaces, are fundamental points of difference from any known Chætopod.

As to the mutual relations of the various orders, the Branchiopoda, with their very generalised structure and parapod-like limbs, may be taken as the base of the series. The Ostracoda, Copepoda, and Cirripedia are best conceived as derivatives, along separate lines, of an ancestral form common to them and the Branchiopoda. By a differentiation of the post-cephalic limbs, and a reduction in the number of segments, the branchiopod type easily passes into that of the Phyllocarida, which, though they nearly conform to the malacostracan type of segmentation, have still marked traces of relationship with lower groups in the presence of caudal styles and in their bivalved carapace and foliaceous thoracic appendages. Next to these in ascending order would come the Cumacea with their cephalic carapace coalescent with the first three or four thoracic segments and bounding branchial cavities at the sides of the thorax, but with—as more primitive features—a biramous character in some of the thoracic appendages and the absence of the fan-like tail-fin. Then a little higher, the Arthrostraca (Tanaidacea, Isopoda and Amphipoda) and the Anaspidacea may be supposed to have branched off from the main trunk at about the same level, and may be regarded, on account of a number of resemblances, as having had a common origin from it. Probably the Anaspidacea are to be looked upon as more

primitive than the other two groups in view of the less advanced coalescence of the first thoracic segment with the head, the absence of specialised maxillipedes, and the biramous character of the thoracic limbs ; but, on the other hand, they show a higher development in the possession of the fan-like tail-fin and the stalked movable eyes such as characterise the Decapoda.

A stage nearer the latter group are the Mysidacea, with their single pair of maxillipedes, their stalked eyes, their rudimentary

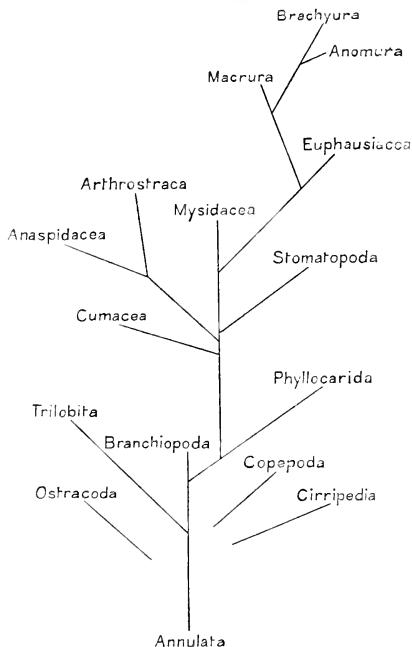

FIG. 483.—Diagram illustrating the mutual relationships of the orders of Crustacea.

podobranchiæ and their fan-like tail-fin ; but these still show some primitive features, more especially in their incomplete cephalothorax and their biramous thoracic appendages. But without doubt it is in the Euphausiacea that we find the nearest connections with the Decapoda. This is shown, in spite of the absence of maxillipedes, in their completed cephalothorax, their series of podobranchiæ, and sac-like heart, in addition to their stalked eyes and fan-like tail-fin.

From the Euphausiacea the Macrura are derivable by the differentiation of three pairs of foot-jaws and the disappearance of the exopodites of the legs. In the series of the Macrura we find, on passing from the Prawns through such forms as *Astacus*, *Palinurus*, and *Scyllarus*, a gradual shortening of the abdomen, accompanied by a broadening and flattening of the whole body. In *Birgus*, *Hippa*, &c., this process goes a step further, and the abdomen becomes permanently flexed under the cephalothorax, thus leading to the high degree of specialisation found in the Crabs.

These relationships are expressed in the diagram on page 588.

APPENDIX TO CRUSTACEA.

Class TRILOBITA.

The Trilobita are extinct Arthropods peculiar to, and characteristic of, the Palæozoic rocks: they are specially abundant from the upper Cambrian to the Carboniferous. They are often found in a wonderfully good state of preservation, owing to the hard exoskeleton covering the dorsal surface: the

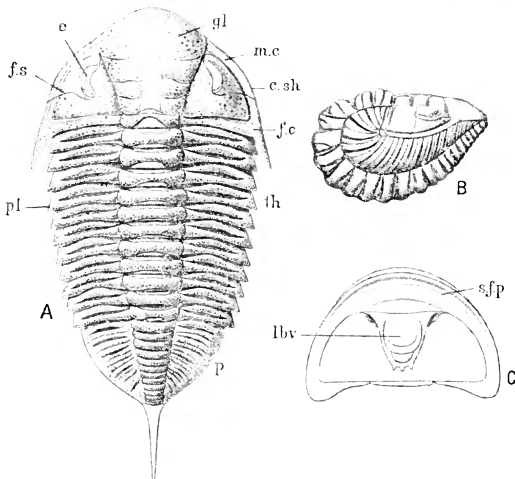

FIG. 484.—*Dalmanites socialis*, dorsal aspect; *B*, the same rolled up; *C*, under-side of head of *Phacops fecundus*. *c.sh.* cephalic shield; *e.* eye; *f.c.* fixed cheek; *f.s.* frontal suture; *gl.* glabella; *lbv.* labrum; *m.c.* movable cheek; *p.* pygidium; *pl.* pleura; *s.f.p.* sub-frontal plate; *th.* thorax. (After Gerstaecker.)

greater part of the ventral region and the appendages were, however, very delicate, and are preserved only in exceptionally favourable cases.

The body is depressed, more or less oval in outline, and divided into three regions, the head (Fig. 484, *c.sh.*), the thorax (*th.*), and the abdomen (*p.*), all of which usually present an elevated median ridge and depressed lateral portions,

whence the trilobation generally characteristic of the group. The head is covered by a carapace or *cephalic shield* (*c.sh*), the elevated median region of which, known as the *glabella* (*gl*), usually presents three or four transverse grooves, probably indicating the presence of four or five segments. The lateral

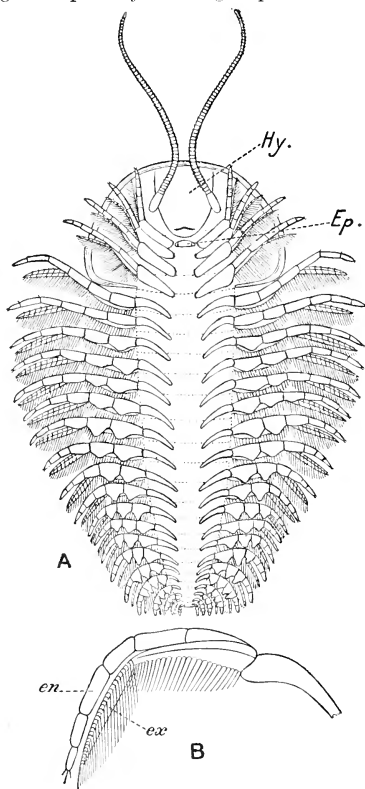

FIG. 485.—*Triarthrus becki*, 21. A, ventral surface with appendages; *Ep*, metastome; *Hy*, hypostome. B, second thoracic appendage. *en*, endopodite; *ex*, exopodite $\times 12$. (From the *Cambridge Natural History*, after Beecher.)

regions of the carapace are divided by an oblique line of separation, the *frontal* or *facial suture* (*f.s.*), into an inner or mesial portion, the *fixed cheek* (*f.c.*), continuous with the glabella, and an outer free portion, the *movable cheek* (*m.c.*); the latter bears the large paired compound eye (*e*). In some cases there is an indication of a dorsal organ, like that of *Apus*, on the last cephalic segment. Ventrally the carapace is continued, as in *Apus*, into a sub-frontal plate (*C, s.f.p.*), to the posterior edge of which is attached a large labrum or hypostome (*lv*). In many Trilobites the hypostome bears a pair of small compound eyes. The posterior angles of the carapace are often produced into spines.

The thorax (*th*) is composed of a variable number (2-29) of movably articulated segments, which are commonly trilobed, consisting of a median region or *axis*, and of lateral *pleura* (*pl*) often produced backwards and downwards into spines. The abdomen is covered by a *caudal shield* or *pygidium* (*p*), formed of a variable number of fused segments. Owing to the mobility of the thorax, the Trilobites were able in many cases to roll themselves up like Wood-lice (*B*). Each of the segments, with the sole exception of the last or anal, bore a pair of appendages.

The appendages are known only in a few cases. Quite recently a single pair of antennæ (Fig. 485) has been shown to exist in one species, probably attached to the sub-frontal plate. There are no true jaws. Four pairs of biramous leg-like cephalic appendages have been demonstrated, and the thorax bears slender biramous legs with endo- and exopodites, and bearing spiral gills. Similar limbs are present on the abdomen.

The larvæ of several species of Trilobites have been found in the fossil state. In some of these stages the body consists only of carapace and pygidium in the youngest, and the thoracic segments are subsequently intercalated in regular order. In other species the earliest stage has the form of a rounded plate, the posterior portion of which elongates and segments to form the thorax and abdomen. Nothing is known of the larval appendages, and none of the stages hitherto discovered can be considered as nauplii.

The precise systematic position of the Trilobites is uncertain, but their nearest affinities seem to be, on the whole, with such Branchiopoda as *Apus*; the relationship is, however, by no means a close one.

CLASS II.—ONYCHOPHORA.

The class Onychophora comprises only the aberrant arthropod *Peripatus*, with several sub-genera (or closely allied genera), which differs very widely in certain important features of its organisation from all the rest of the Arthropoda, and in some respects enables us to bridge over the interval between the latter and some of the lower phyla, more particularly the Annulata.

General external features.—*Peripatus* (Fig. 486) is a caterpillar-like animal of approximately cylindrical form, and not divided

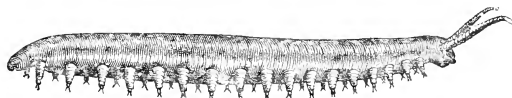

FIG. 486.—*Peripatus (Peripatopsis) capensis*, lateral view. (From Balfour.)

into segments; it has a fairly well-marked head, and a series (14—42, according to the species) of pairs of short stumpy appendages. The integument is thrown into a number of fine transverse wrinkles, and is beset with numerous conical papillæ, each capped with a little chitinous spine. The head (Fig. 487) bears a pair of antennæ, a pair of eyes, a pair of jaws, and a pair of short processes known as the *oral papillæ*. The antennæ are made up of a number of short rings bearing minute spines. The eyes are constructed somewhat after the model of the chætopod eye as described on p. 437. On the surface of the oral papillæ are situated the apertures of a pair of glands—the *slime-glands*. Each *jaw* is composed of two curved, falciform, pointed, chitinous plates, the inner toothed on its posterior concave edge; they lie at the sides of the mouth enclosed by a circular lip. The jaws, as well as the oral papillæ, are developed as modified limbs.

The *legs* are not jointed, but rows of papillæ give them a ringed appearance; each consists of a conical proximal part and a small distal part or *foot*, the latter terminating in a pair of horny claws.

The ventral surface is reddish in colour, the dorsal darker: the latter presents an elaborate pattern—which varies greatly in different individuals—produced by minute mottlings of various

colours and tints, green, red, and brown, and the arrangement of these in stripes and bands.

Body-wall and body-cavity.—The wall of the body consists of a cuticle, a layer of deric epithelium with an underlying layer of fine fibres, a layer of circular muscular fibres, and one of longitudinal muscular fibres divided into a series of bundles. A layer of epithelium lines the wall of the body-cavity and invests the contained organs. Incomplete muscular partitions divide the cavity into a median and two lateral compartments, in addition to the pericardium, or space in which the heart is lodged; the lateral compartments send prolongations into the legs. The body-cavity

is not a cœlome, but, as shown by its development, a hæmocœle—an extension of the blood-vascular system—as in the Crustacea.

The **enteric canal** (Fig. 488) begins with a small *buccal cavity*, formed secondarily by the union of a ring of papillæ and folds surrounding the true mouth into a circular lip: it encloses the bases of the jaws and bears on its roof a slight prominence, the *tongue*, with a row of small spines or teeth. This is

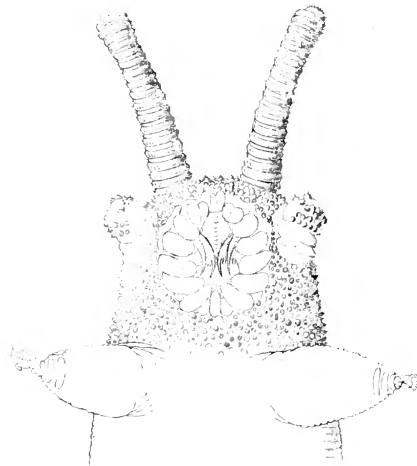

FIG. 487.—Ventral view of head of *Peripatus (Peripatopsis) capensis*, with antennæ, jaws, oral papillæ, and first pair of legs. (After Balfour.)

followed by a thick-walled *pharynx (phar.)* leading to a narrow *œsophagus*. The part which follows, the *mesenteron* or stomach-intestine, a wide somewhat thin-walled tube, extends nearly to the posterior end of the body. The narrower *rectum* leads to an anal aperture situated on the last segment of the body. A diverticulum leading backwards from the buccal cavity, where it passes into the pharynx, receives the secretion of two long, narrow, tubular *salivary glands (sal. gland.)*.

Circulatory system.—The *heart* is an elongated tube running through nearly the entire length of the body. It presents a number of pairs of valvular ostia arranged segmentally—*i.e.*, one opposite each pair of legs. It is enclosed in a pericardial sinus

imperfectly cut off from the general body-cavity by a longitudinal partition.

The organs of respiration (Fig. 489) are delicate, unbranched or rarely branched, *tracheal tubes*, lined with a thin chitinous layer exhibiting fine transverse striations. Groups of these open in little depressions of the integument, the tracheal pits (*tr.p.*), the external openings of which are known as the *stigmata* (*tr.o.*). The stigmata are usually distributed irregularly over the surface, with a tendency to arrangement in rows in *P. capensis*. By means of these tubes air is conveyed to all parts of the body.

A series of pairs of glands, the **coxal or crural glands** (Fig. 488, *cox. gland.*), lie in the lateral compartments of the body-cavity, and their ducts open on the lower surfaces of the legs just outside the nephridial apertures. They are absent in the female except

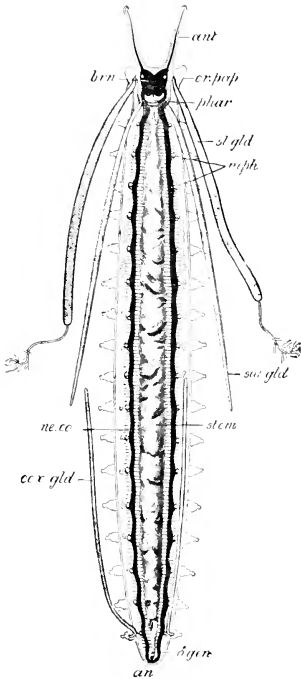

FIG. 488.—Dorsal view of the internal organs of *Peripatus*. *an.* anus; *ant.* antennæ; *brn.* brain; *cox. gland.* coxal gland of the seventeenth leg; *♂ gen.* male genital aperture; *ne. co.* nerve-cord; *neph.* nephridia; *or. pap.* oral papillæ; *phar.* pharynx; *sal. gland.* salivary gland; *sl. gland.* slime gland; *stom.* stomach. (Combined from Balfour.)

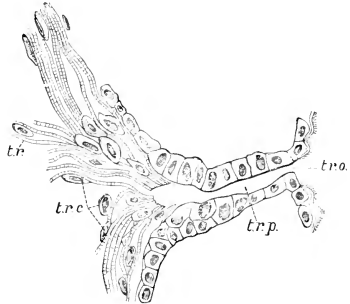

FIG. 489.—Section through a tracheal pit and diverging bundles of tracheal tubes of *Peripatus*. *tr.* tracheæ; *tr. c.* cells in walls of tracheæ; *tr. o.* tracheal stigma; *tr. p.* tracheal pit. (From *Camb. Nat. Hist.*, after Balfour.)

in *P. capensis*, and their number and arrangement differ in the males of the various species. Also opening on the ventral surfaces of the legs are a series of thin-walled vesicles—the **coxal organs**: these occur in both sexes and are capable of eversion and retraction. A pair of large glands—the **slime-glands** (*sl. gland.*)—opening at

the extremities of the oral papillæ, may be modified coxal glands : the secretion of these is discharged in the form of a number of fine viscid threads when the animal is irritated, and appears to serve a defensive purpose.

The **nervous system** consists of a *brain* (*brn.*) situated in the head, and of two *longitudinal nerve cords* (*ne. co.*) which run parallel with one another throughout the body to the posterior end, where they join together behind the anal aperture. A number of very fine transverse commissures, more numerous than the segments (*i.e.*, than the pairs of limbs), connect the two cords together to form a ladder-like nervous system comparable to that of some of the Flat Worms. The cords are very slightly swollen opposite each pair of limbs : nerve-cells cover them uniformly throughout their entire length. The brain gives off nerves to the antennæ.

The nerves to the jaws are given off just where the brain passes into the longitudinal nerve cords.

The excretory organs are **nephridia** (Fig. 490) of the type of those of the Annelata, situated in pairs in the lateral compartments of the body-cavity, and opening on the lower surfaces of the legs at their bases. Each nephridium consists of a thin-walled closed internal vesicle, representing a section of the cœlome, into which by a funnel-shaped aperture leads

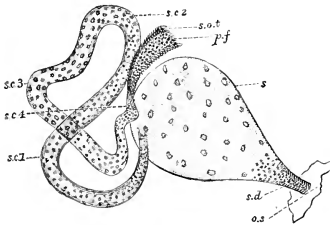

FIG. 490.—*Peripatus capensis*, nephridium from the ninth pair of legs. *o.s.*, external opening ; *p.f.*, internal opening into the lateral compartment of the body-cavity ; *s.*, vesicle of nephridium ; *s.c. 1*, *s.c. 2*, *s.c. 3*, *s.c. 4*, successive regions of coiled portion ; *s.o.t.*, third portion of nephridium broken off at *p.f.* from the internal vesicle, which is not shown. (From the *Camb. Nat. Hist.*, after Balfour.)

a looped tube (*s.c.*), and a dilated *terminal vesicle* (*s.*), situated close to the external opening. The salivary glands are, as shown by the study of their development, specially modified nephridia, as apparently also are a pair of glands—the *anal glands*—opening close to the anus.

Reproductive organs.—*Peripatus* has the sexes distinct. In the female there are two tubular *ovaries*, a pair of *oviducts*, and two *uteri*, the latter in the form of long curved tubes which unite behind in a median vagina opening on the exterior on the ventral surface, between the legs of the last pair or behind them. In the oviparous forms the opening is situated at the end of a long cylindrical process—the *ovipositor*. In some species, connected with each uterus where it leaves the ovary, are two diverticula—the *receptaculum seminis* and *receptaculum ovarum*. In certain species one or other of these may be absent.

In the male there are two tubular *testes*, each with a narrow *vas efferens* opening by a funnel-like aperture into a *vesicula seminalis* ;

this is followed by a long, narrow, coiled *vas deferens*. The two *vasa deferentia* unite together to form a median tube—the *ductus ejaculatorius*—opening on the exterior, in the same position as the vagina of the female. The wall of the proximal part of the ejaculatory duct is glandular, and secretes a substance forming complicated cases which enclose masses of sperms to form spermatophores.

Development.—The differences between the species of *Peripatus* as regards the segmentation of the egg and the formation of the germinal layers as described by various observers are very considerable. Nearly all the species are viviparous, but in some the egg, before the completion of embryonic development, is enclosed in a well-formed shell, and in certain species the eggs pass out to the exterior before the emergence of the embryo. In some species

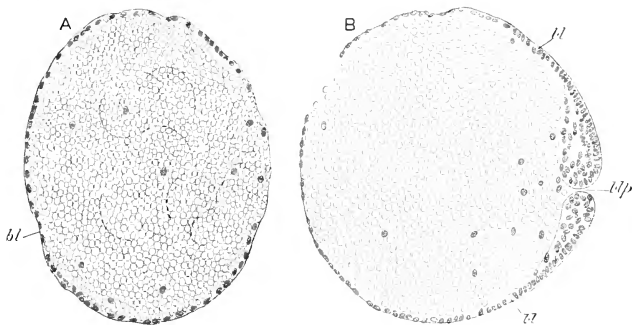

FIG. 491.—Two early stages in the development of *Peripatus novae-zealandiae*. *A*, transverse section of an ovum in which the yolk is nearly covered by the blastoderm (*bl*); *B*, transverse section of an ovum in which the blastopore (*blp*) is formed. (After Sheldon.)

the egg encloses a considerable amount of food-yolk, in others the quantity of food-yolk is small, and nutriment is obtained from the parent.

In *P. novae-zealandiae* there is a superficial segmentation. The first segmentation-nucleus is itself superficial, and segmentation results in the development of a number of nuclei, each with its island of protoplasm, which arrange themselves on what is destined to become the dorsal side (Fig. 491, *A*), opposite the site of the future blastopore, while some pass inwards to the central part of the ovum. The peripheral nuclei multiply rapidly and grow round the yolk so as completely to enclose it except on a small space (blastopore) in the middle of the ventral side (*B*). There a thickening takes place, and an involution of the lips of the blastopore results in a sort of invagination, the floor of the invagination-cavity being formed of yolk with scattered nuclei.

In another species—*Peripatopsis capensis*—the segmentation is total. A peripheral ectodermal layer becomes formed, enclosing a central mass of cells—the endoderm—except at one point where a small area, the blastopore, is uncovered.

In accordance with the smaller size of the ova and the relationship of the embryo with the wall of the uterus, the South American

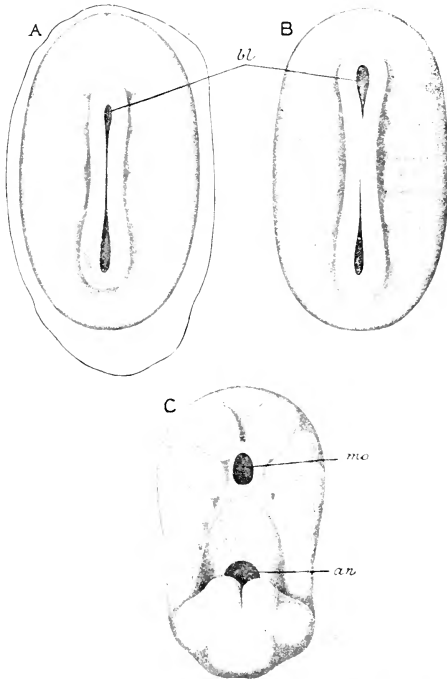

FIG. 492.—Three somewhat later stages in the development of *Peripatus capensis*, showing the mode of closure of the blastopore and the appearance of the primitive segments. *A*, stage in which the blastopore (*bl.*) has the form of an elongated slit; *B*, stage in which the blastopore is closing up in its middle part; *C*, stage in which the blastopore has become closed up except the anterior part which has gone to form the mouth (*mo.*), and the posterior part which has formed the anus (*an.*); the whole embryo has now become strongly curved towards the dorsal side. (After Balfour.)

species show a totally different mode of development. The eggs, which are almost entirely devoid of yolk, undergo a total and tolerably equal process of segmentation. Even at this stage the embryo, which increases considerably in size, appears to receive nutrient lymph from the uterine wall. Later an intimate connection

is established between the embryo and a modified area of the uterine epithelium, the *placenta* thus formed evidently providing, like the placenta of Mammals, for the nourishment of the embryo.

In *P. capensis* (Fig. 492) proliferation of cells gives rise to an oval thickening behind the elongated blastopore. The mesoderm takes its origin at this point and extends forwards in the form of two *germinal bands*, one on the right of the blastopore and the other on the left. These bands undergo a division into rudiments of segments—the division beginning in front. The lips of the blastopore meanwhile become approximated, and fuse throughout the greater part of their length, leaving only an anterior and a posterior opening; these go to form the mouth and the anus respectively. The division into segments soon becomes well marked. The cavities in the mesoderm of the segments give rise only to the internal vesicles of the nephridia and the generative ducts, which thus alone represent the coelome. The nephridia themselves are developed as ingrowths of the ectoderm. At the anterior end the head lobes become distinguishable. The body elongates, and the head and trunk become differentiated. The limbs now arise as ventro-lateral outgrowths which are developed from before backwards. The jaws originate in the same manner as the limbs, as external projections, and only later become enclosed by folds that give rise to the buccal cavity of the adult.

Distribution.—The various species of *Peripatus* are all terrestrial, and are found in damp localities, under bark, or dead timber, or stones. Some twenty-nine species occur in the Neotropical region; one in South America; eight in Africa; four in Malaya; one in New Britain, and eight in Australasia.

Relationships.—*Peripatus* is the most primitive of existing Arthropods, and presents some striking points of resemblance to the Chætopoda. The development is in the main arthropodan, especially as regards the mode of segmentation (at least in the forms with much food-yolk, which are probably the more primitive), the mode of closure of the blastopore, and of the development of the germinal bands. Arthropodan also are the relatively large size of the brain and the presence of tracheæ, the character of the heart with its pairs of ostia, together with the clawed appendages, and the jaws in the form of modified limbs. The nephridia, on the other hand, and their modification in certain segments to form the gonoducts, which are ciliated internally, are annulate in character; and in all probability the slime glands and coxal glands correspond to the setigerous sacs of the Chætopoda. The nervous system is peculiar, and is most nearly paralleled among the Platyhelminthes and the Mollusca. Also peculiar, and serving to distinguish *Peripatus* from the rest of the Arthropoda, are the large number of stigmata and their irregular arrangement, the presence of only a single pair of jaws, and the nature of the cuticle.

CLASS III.—MYRIAPODA.¹

The class Myriapoda, including the Centipedes and the Millipedes, consists of tracheate Arthropoda, which present many features of resemblance to the Insects. There is a distinct head, bearing many-jointed antennæ, a pair of eyes, and two or three pairs of jaws; the body is not distinguishable into regions, but consists of a number of similar segments, each bearing either one pair of legs or two pairs. A system of air-tubes or tracheæ, similar to those of *Peripatus* and the Insects, opens by a series of stigmata, usually in considerable numbers, on the sides or lower surfaces of the segments.

A.—DISTINCTIVE CHARACTERS AND CLASSIFICATION.

The Myriapoda are tracheate Arthropoda in which there is a head, bearing antennæ and jaws, and a trunk made up of a number of similar segments, provided with leg-like appendages. Groups of ocelli are present on the head.

Sub-Class I.—PROGONEATA.

Myriapoda in which the genital apertures are situated far forwards towards the anterior end of the body.

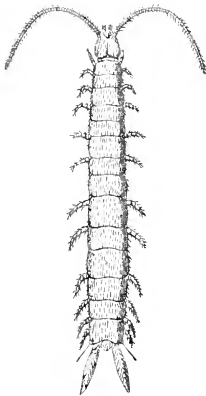

FIG. 493. — *Scolopendrella immaculata*. (From Leuckart, after Latzel.)

ORDER 1.—PAUROPODA.

Progoneata with ten trunk-segments and nine pairs of legs, one pair to each segment except the first. Antennæ with several flagella. Tracheæ not known. The order includes only the two genera *Pauropus* (Fig. 496) and *Eurypauropus*.

ORDER 2.—DIPLOPODA (CHILOGNATHA).

Progoneata with a body composed of a considerable number of apparent segments, each of which, with the exception of the first three, bears two pairs of legs and represents two true segments united. There are no maxillipedes.

This order includes the Millipedes.

¹ As will appear subsequently, the class Myriapoda, as formerly understood, comprises two groups which are separated from one another by such important differences that they might very well be looked upon as constituting two distinct and independent classes. The old class Myriapoda is retained here as a matter of convenience, and the two constituent groups are ranked as sub-classes.

ORDER 3.—SYMPHYLA.

Progoneata in which there are not more than twelve leg-bearing segments, and in which there is only a single pair of branching tracheæ, the two external apertures of which are situated in the head. Not more than three pairs of jaws. Feet with two claws.

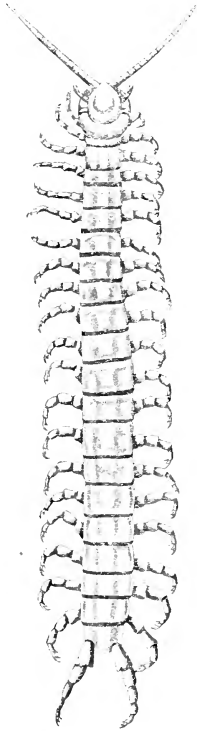

FIG. 494.—*Scolopendra*. (From Cuvier's *Animal Kingdom*.)

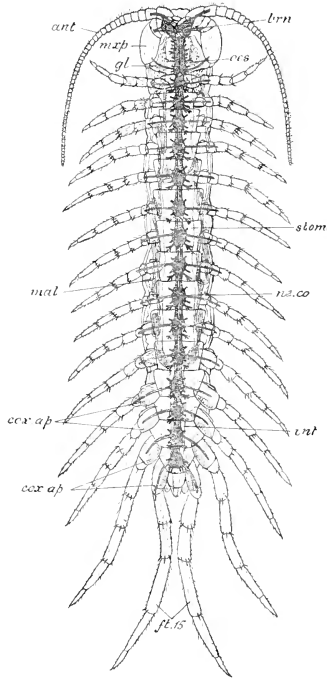

FIG. 495.—*Lithobius forficatus* seen from the ventral side. *ant.* antennæ; *brn.* brain; *cox. ap.* coxæ of appendages; *fl. 15.* fifteenth pair of legs; *int.* intestine; *mal.* Malpighian tubes; *mxp.* maxillipedes; *ne. co.* nerve cord; *æs.* œsophagus; *stom.* stomach. (From Leuckart.)

This order includes only the two genera *Scolopendrella* (Fig. 493) and *Scutigera*.

Sub-Class II.—OPISTHOGONEATA.

Myriapoda in which the genital apertures are situated at the posterior extremity of the body.

ORDER 1.—CHILOPODA (SYNGNATHA).

Opisthgoneata with numerous (15—173) trunk-segments, each bearing a single pair of legs. Numerous tracheæ opening in pairs of stigmata on the sides of a number of the segments. Four pairs of jaws, including a pair of poison-jaws. Feet with a single claw.

This order includes the Centipedes (Fig. 494) and *Scutigera*.

GENERAL ORGANISATION.

External Features.—The *head* in the Myriapoda is as well marked off as in an Insect; it appears to be composed of about four fused segments. The *antennæ* consist sometimes of many, sometimes of comparatively few segments; in *Pauropus* they are branched. A pair of *eyes*, situated on the dorsal surface of the head, consist of aggregations of ocelli except in *Scutigera*, in which there are compound eyes, differing, however, in their structure from those of Insects. There are a movable *labrum*, a pair of *mandibles*, and two pairs of *maxillæ*. The mandibles have no palps; one or both pairs of maxillæ usually possess palps; the second pair of maxillæ are in some groups more or less united together. In the Chilopoda the first pair of legs of the trunk are specially modified to act as poison-jaws (maxillipedes), by means of which the Centipede inflicts its poisonous bite.

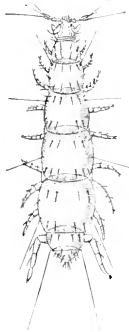

FIG. 496.—*Pauropus huxleyi*. (From Leuckart, after Latzel.)

The number of segments in the body varies from 10 to 173. In the Millipedes the dorsal walls of the segments are very strongly arched; in the Centipedes the segments are all dorso-ventrally compressed, with distinct tergal and sternal shields separated laterally by intervals of comparatively soft skin on which the stigmata open. In the Chilopoda each segment bears a pair of jointed legs; of these the most anterior pair is extended forwards, as already stated, to form a pair of poison-jaws (*maxillipedes*), at the extremity of the pointed terminal joint of which opens the duct of a poison-gland. In the Diplopoda each segment behind the fourth or fifth bears two pairs of legs, the four or five most anterior having only one pair each. In most of the Diplopoda the appendages of the seventh segment are modified in the male to form copulatory organs.

The **integument** and **body-wall** do not differ widely from those of Insects (see p. 621). The exoskeleton is a thickened chitinous cuticle which is calcified in Diplopoda. Odoriferous glands are present in most Diplopoda on some of the body-segments, and open on the dorsal surface. *Scolopendrella* possesses spinning glands.

The **alimentary canal** is straight, and is much simpler in character than that of the Insecta. There is a pair of salivary glands; and one or two pairs of *Malpighian tubes*, having a renal function, open into the beginning of the hind-gut.

The **heart** is a greatly elongated tube, divided into a number of chambers.

The **respiratory system** resembles that of Insects, which will be fully dealt with later, consisting of air-tubes or *tracheæ*. There is one pair of stigmata in each true segment in the Diplopoda (two pairs in each apparent segment). Each stigma leads into an air-chamber from which a large number of tracheæ are given off. In some Diplopoda the tracheæ are branched, in others unbranched: the tracheæ of one group do not anastomose with those of other groups. In the Chilopoda the number of stigmata is in most cases less than the number of segments, and the tracheæ anastomose, often forming longitudinal trunks which may extend throughout the body. In *Scutigera* the stigmata are unpaired and dorsal, and each leads into a large air-chamber which gives off on either side a large number of radially arranged short air-tubes—the whole forming a sort of lung.

In the Symphyla there are only two stigmata, and these are situated on the head.

The **nervous system** is, in accordance with the form of the body, much less concentrated than in the Insecta (see p. 628). There is a brain, a pair of œsophageal connectives, and a ventral nerve-cord consisting of a series of double nerve-ganglia, one in each segment, with double connectives between them. The double character of the ventral cord is much more distinctly marked in the Chilopoda than in the Diplopoda, the ganglia are more distinct, and the first three are intimately united together into an infra-œsophageal mass. A sympathetic or visceral nervous system is present, at least in the Diplopoda.

The **sexes** are always separate. There is usually an unpaired gonad with paired ducts. In the Chilopoda the single genital aperture is situated at the posterior end of the body: in the Diplopoda and Paurpoda the two apertures are placed far forwards towards the anterior end.

The **ovum**, as in most Arthropods, contains a large quantity of food-yolk. The centrally-placed segmentation-nucleus divides so as to give rise to a number of nuclei, this division being accompanied by a partial division of the yolk into a number of masses. The nuclei then, for the most part, migrate to the surface, some being left behind in the yolk. Those that reach the surface, surrounded each by its little clump of protoplasm, become arranged into a continuous superficial layer of cells—the *blastoderm*. On the surface of this appears a thickening—the *ventral plate*—and along the thickening is formed a groove which may perhaps repre-

sent the blastopore, though the endoderm is formed by direct modification of the cells in the interior of the yolk. Stomodæum and proctodæum are developed as invaginations of the surface layer. The thickening of the blastoderm gives rise to a pair of germinal bands in which rudiments of the segments soon become recognisable. Larval membranes do not occur.

In some of the Diplopoda there is a metamorphosis, such as will shortly be described in the embryo Insect, and the larva (Fig. 497, *B*) has a singular superficial resemblance to an Insect, owing to the presence at first of only three pairs of appendages on the anterior trunk region.

Fossil remains of Myriapoda have been found in strata as far back as the Devonian. The more ancient fossil forms are not

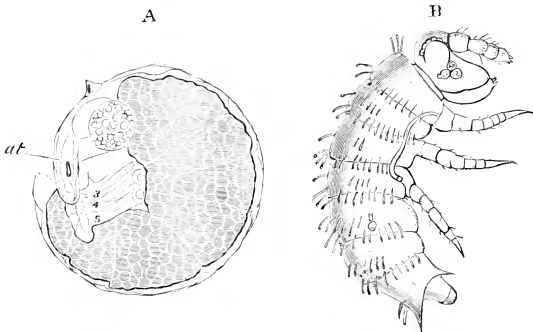

FIG. 497.—Two stages in the development of **Strongylostoma**, one of the Diplopoda. *A*, early stage in the formation of the larva, which already exhibits distinct segments; *at*, antennæ. *B*, larva immediately after hatching. (From Balfour, after Metschnikoff.)

capable of being grouped in the same orders as the living representatives of the class, and are looked upon as constituting at least two orders, the members of which are all extinct. While the Progoneata, and, more especially, the Symphyla, show marked resemblances to the Insecta—more particularly to some of the members of the order Aptera, the Opisthgoneata have features connecting them through the Onychophora with the Annulata.

CLASS IV.—INSECTA.

The class of Insects (comprising the Cockroaches, Grasshoppers, Dragon-flies, House-flies, Butterflies, Beetles and Bees, with their many allies), though it is a very extensive one—including as it does a larger number of species than any of the other classes of the Arthropoda—is yet characterised by a remarkable degree of uniformity, no such extremes of modification occurring as are observable within the class Crustacea.

Characteristic of all the members of the class is the presence of three clearly-defined regions—the head, thorax, and abdomen. There are present on the head, antennæ, mandibles, and two pairs of maxillæ, the jaws being variously modified in the different orders. All Insects have three pairs of thoracic legs, and most have either one or two pairs of wings likewise borne on the thorax; the abdomen is not provided with paired appendages.

The organs of respiration are tracheæ similar to those of the Myriapoda.

The various systems of internal organs attain a very high grade of structure in all the higher groups of Insects. In most the development is complicated by the occurrence of a strongly-marked metamorphosis. Insects are terrestrial or aerial, only a few groups living on the surface of, or immersed in, fresh or salt water; but many are aquatic throughout their larval condition.

Many groups of Insects are remarkable for the high grade of their intelligence as compared with the members of other classes of the animal kingdom. This manifests itself mainly in a number of instincts, often of a remarkable character, having to do with the protection and rearing of the young; and in some cases leading to the formation of communities consisting of individuals of various different kinds (workers, soldiers, sexual individuals) for mutual support and protection.

1. EXAMPLE OF THE CLASS—THE COCKROACH (*Periplaneta orientalis* or *P. americana*).

The Cockroach, familiarly known by the misleading title of "Black Beetle," is a common pest of kitchens, bakeries, and store-rooms. It is nocturnal in its habits, rarely coming out of its lurking-places in the daytime, and is almost omnivorous in its diet. It is a good example of the Insecta, not only on account of its large size, which renders it convenient for dissection, but also because of its generalised structure, which makes it a fairly central member of the class, devoid of any extreme modifications.

Three regions are very distinctly recognisable in the body of the Cockroach (Fig. 498). In front is the *head*, elongated vertically, bearing the very long, slender *feelers* or *antennæ* and the large *eyes*, and contracted behind to form a narrow *neck*. In the middle is the *thorax*, consisting of three segments, bearing the three pairs of *legs* and the two pairs of *wings*. Behind is the *abdomen*, consisting of ten segments covered over above by the wings in the male. The entire surface is invested by a chitinous cuticle, which is especially thickened on the head, on certain parts of the thorax, and on the anterior pair of wings.

The **head** consists of four parts—the *epicranium* behind, comprising the region between and behind the eyes; the *clypeus*,

or portion extending vertically downwards; and two lateral parts, the *genæ*, in front. The eyes are a pair of reniform black patches on the sides of the head; each is seen when examined with a lens to be divided into a number of minute hexagonal areas or *facets*, like those in the eye of the Crayfish. Borne in sockets just below the eyes are the long, slender, highly mobile feelers or *antennæ*, each made up of a large number of small segments, the first three being larger than the others. Internal to the base of each antenna is a rounded white space—the *fenestra*—the nature of which is not

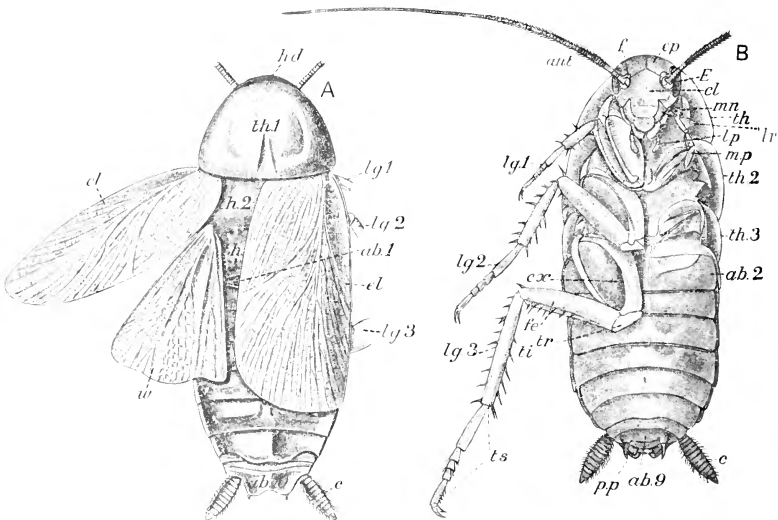

FIG. 498.—*Periplaneta orientalis*, male. *A*, dorsal view. *B*, ventral view $\times 2$. *ab.1*, *ab.2*, *ab.9*, *ab.10*, first, second, ninth, and tenth segments of abdomen; *ant*, antennæ; *c*, cerci; *cl*, clypeus; *cx*, coxa of third leg; *E*, eye; *cl*, elytra; *ep*, epiceranium; *f*, fenestra; *fe*, femur of third leg; *hd*, head; *lg.1*, *lg.2*, *lg.3*, legs; *l.p.*, labial palp; *tr*, labrum; *mn*, mandible; *m.p.*, maxillary palp; *p.p.*, style on ninth abdominal segment, internally to which a podical plate is seen; *th.1* (*th.* in *B*), *th.2*, *th.3*, segments of thorax; *ti*, tibia; *tr*, trochanter; *ts*, tarsus; *w*, posterior wing.

known, but which may be an abortive representative of the simple eyes or *ocelli* found in most Insects.

Movably articulated with the lower or ventral end of the clypeus is a broad plate, the *labrum* or upper lip (Fig. 499, *lbr.*) overhanging the aperture of the mouth. Below the *genæ* and articulating with the sides both of the epiceranium and of the clypeus are a pair of stout *mandibles* (Fig. 499, *md.*, and 500, *man.*) which work horizontally like those of the Crayfish; their inner edges are divided into a number of teeth. Behind the mandibles are a more flexible

pair of jaws—the first pair of *maxillæ* (*mx.*₁, *mx.*¹). Each maxilla exhibits a structure comparable to the fundamental type of the appendages of the Crayfish:—a basal part or *protopodite*, consisting of two segments (podomeres), supporting an internal ramus or *endopodite*, and an external ramus or *exopodite*. The former consists of two parts: an inner, pointed, hard blade—the *lacinia* (*mi.*), and an outer, softer, more elongated—the *galea* (*me.*). The exopodite forms a palp, the *maxillary palp* (*pm.*), consisting of five podomeres. Behind these are the second maxillæ, which are reducible to the same type, but which have their two basal segments (those of the protopodites) united together in the middle line to form two median

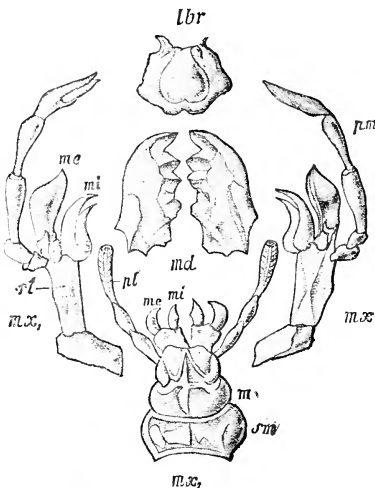

FIG. 499.—Mouth parts of the **Cockroach**. *lbr*, labrum; *m*, mentum; *md*, mandible; *mx*₁, anterior pair of maxillæ; *me*, and *mi*, outer and inner divisions of the first and second pair of maxillæ; *mx*₂, second maxillæ; *pl*, labial palp; *pm*, maxillary palp; *st*, stipes; *sm*, submentum. (From Lang's *Comparative Anatomy*.)

sclerites, known respectively as *mentum* (*m.*) and *submentum* (*sm.*), so that the two appendages

form a sort of lower lip called the *labium*. The endopodites taken together constitute what is termed the *ligula*; each is divided into two parts like the endopodite of the first maxillæ. The exopodites form three-jointed palps, the *labial palps* (*pl*). A soft pear-shaped median process—the *tongue*, *lingua* or *hypopharynx*, is attached to the upper side of the mentum: just behind it is a median slit supported by two chitinous pieces—the entrance to the pharynx.

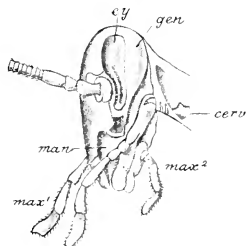

FIG. 500.—**Periplaneta americana**. Lateral view of the head and its appendages. *cerv*, one of the cervical sclerites; *ey*, eye; *gen*, gena; *max*₁, mandible; *max*₁, first pair of maxillæ; *max*₂, second pair of maxillæ (labium).

The *neck*, or narrow region between the head proper and the thorax, is covered for the most part

by a thin flexible cuticle, but supporting it are eight thickened and hardened patches—the *cervical sclerites* (*cerv.*).

Each of the three segments of the **thorax**—known respectively as *prothorax*, *mesothorax*, and *metathorax*—is covered over dorsally by a chitinous plate—the *tergum*, and ventrally by another—the *sternum*. The tergum and sternum of each segment are distinct from one another, not united into a continuous sclerite as in the Crayfish. The tergum of the prothorax is larger than that of the other two segments, and overlaps the neck above. Attached to the anterior border of the tergum of the mesothorax in the male are the anterior wings or *elytra*—a pair of thick opaque plates, which, in their ordinary position, extend backwards over the abdomen to some little distance beyond its extremity. Articulating with the tergum of the metathorax are the *posterior wings*—a pair of extremely delicate membranous expansions, which, when at rest, are folded up longitudinally, like a fan, under the elytra. In the female of *P. orientalis* the wings are only represented by small vestiges. Attached to the sternum of each segment of the thorax is a pair of legs. Each leg consists of a stout flattened proximal podomere or *coxa*; a small second, or *trochanter*; a third, the *femur*, similar to the coxa but narrower; a fourth slender and spinose, the *tibia*; and finally the *tarsus* or *foot*, composed of six very short segments provided ventrally with patches of setæ to give adhesive power; the last segment (*pulvillus*) is armed in addition with a pair of claws (Fig. 498).

Of the segments of the **abdomen** the most posterior are overlapped by those just in front. Each is enclosed in a dorsal *tergum* and a ventral *sternum*, both of which are thinnish and flexible—the terga and sterna of successive segments overlapping one another from before backwards. The eighth and ninth terga are hidden from view by being overlapped by the seventh. The tenth is produced backwards into a thin flexible plate, the posterior border of which presents a deep notch; below this is the opening of the anus, at the sides of which are a pair of small hard plates—the *podical plates*; at the sides of the tergum are a pair of many-jointed palp-like bodies—the *cerci*. The sternum of the first abdominal segment is rudimentary. In the male that of the ninth bears a pair of short styles. In the female the sternum of the seventh is very much more prominent than in the male. The genital aperture is situated on the ventral aspect of the posterior extremity of the abdomen beneath the anal opening.

When compared with the Crayfish, as regards the external anatomy, the Cockroach is found to differ (1) in the arrangement of the segments into regions; (2) in the form and position of the appendages. The head and thorax together correspond to the cephalothorax of the Crayfish, but comprise fewer segments; the abdomen contains a larger number of segments. The single pair

of antennæ probably correspond to the antennules of the Crayfish—the antennæ of the latter not being represented. On this view the homologies of the anterior appendages in the two animals may be expressed in the following table :—

CRAYFISH.	COCKROACH.
Antennules.	Antennæ.
Antennæ.	Absent.
Mandibles.	Mandibles.
First maxillæ.	First maxillæ.
Second maxillæ.	Second maxillæ (labium).
First maxillipedes.	First legs.
Second maxillipedes.	Second legs.
Third maxillipedes.	Third legs.

Representatives of the five pairs of thoracic legs of the Crayfish would thus appear to be absent in the Cockroach, and evanescent rudiments, no traces of which remain in the adult, alone represent in the latter the well-developed abdominal appendages of the former.

In the living Cockroach **respiratory movements** are to be observed, in which the abdomen becomes alternately expanded and contracted; these movements bring about the alternate inhalation and exhalation of air through certain apertures—the *stigmata*—at the sides of the body. Two of these are situated on each side of the thorax, one between the prothorax and mesothorax, and the other between the mesothorax and the metathorax. Eight occur on either side in the abdomen between the terga and sterna of the segments. Just internal to each spiracle the main air-tube or trachea into which it leads presents an elastic ring or spiral, acting as a valve for closing the passage.

The principal sets of **muscles** of the trunk of the Cockroach are (1) the *longitudinal sternal muscles* (Fig. 501, *long. stern.*), which form a transversely segmented sheet, extending between adjoining sterna of the thorax and abdomen; (2) *oblique sternal muscles* (*obl. stern.*), confined to the abdomen;

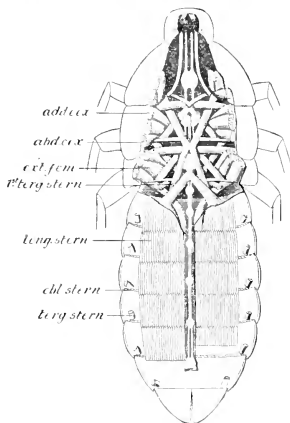

FIG. 501.—Ventral portion of the muscular system of the **Cockroach**. *abd.cox.*, abductor of coxa; *abd.cox.*, abductor of coxa; *ext.fem.*, extensor of femur; *1st terg.stern.*, first tergo-sternal; *long.stern.*, longitudinal sternal; *obl.stern.*, oblique sternal. (After Miall and Denny.)

and (3) *longitudinal tergal muscles*, best developed in the abdomen. The various segments of the limbs are capable of being flexed or extended on one another, as in the Crayfish, by the contractions of special muscles. The wings are little used, the female Cockroach being incapable of flight, and the male not a strong flier: accordingly the wing muscles are not very strongly developed.

Between the body-wall and the alimentary canal is a cavity taking the place of the cœlome, but in reality forming a specially developed part of the blood-vascular system (*hæmocœle*). This is bounded externally by an irregular wall, formed of a mass of polygonal cells constituting the *fat-body*.

Digestive system.—The *mouth* opens into a *buccal cavity* or *pharynx*, which receives the ducts of the *salivary glands* (Fig. 502,

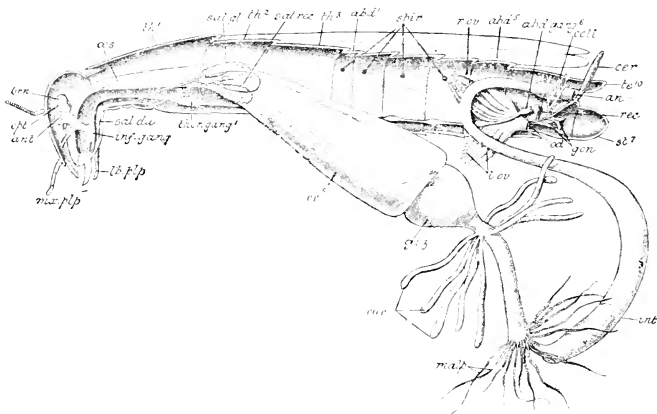

FIG. 502.—Semi-diagrammatic view of the internal organs of female **Cockroach**, dissected from the left side. The heart is not represented. *abd.1*, *abd.5*, first and fifth abdominal segments; *abd. gang.5*, sixth abdominal ganglion; *an.*, anus; *ant.*, antennary nerve; *brn.*, brain; *cer.*, cercus; *cæc.*, cæca; *coll.*, colleterial glands; *cr.*, crop; *gizz.*, gizzard; *gon.*, gonapophyses; *inf. gang.*, sub-oesophageal ganglion; *int.*, intestine; *lb. plp.*, labial palp; *l. ov.*, left ovary; *malp.*, Malpighian tubes; *mx. plp.*, maxillary palp; *od.*, points to the external opening of the median oviduct (vagina); *œs.*, œsophagus; *opt.*, optic nerve; *rec.*, rectum; *r. ov.*, right ovary; *sal. gld.*, salivary glands; *sal. rec.*, salivary receptacle (left); *sal. du.*, salivary ducts, indicating the point at which the median duct of the salivary glands unites with the median duct of the salivary receptacles; *spr.*, stigmata; *st. 7*, sternum of the seventh segment; *tc. 10*, tergum of the tenth segment; *th.1*, *th.2*, *th.3*, first, second, and third segments of the thorax; *thor. gang.1*, first thoracic ganglion.

sal. gld.). Each gland is divided into two lobes, made up of numerous ramifications. In close relation to each gland is an elongated thin-walled sac—the *salivary receptacle* (*sal. rec.*). The duct given off from the salivary receptacle joins that of the opposite side and the median duct thus formed is joined by a single duct (*sal. du.*), formed by the union of the two ducts of the salivary

glands; the common duct thus formed opens into the buccal cavity (Fig. 503).

From the buccal cavity there proceeds backwards a narrow *œsophagus* (*œs.*), which leads to an elongated dilatible sac—the *crop* (*cr.*). On this there follows the *proventriculus* or *gizzard* (*gizz.*)—a pear-shaped chamber with the broad end directed forwards, its chitinous internal lining raised up into a number of teeth. A narrow passage leads from this to the *stomach* or *mesenteron*—a wide tube with glandular walls; from its anterior end are given off eight tubular *hepatic cæca* (*hep. cæ.*)—blind tubes somewhat narrower than the stomach. The point of junction of the stomach with the intestine is marked by the presence of very numerous thread-like yellow appendages—the *Malpighian tubes* (*malp.*)—which are the **renal organs** of the animal. The *intestine* (*int.*) terminates in a dilated portion—the *rectum* (*rect.*)—the walls of which are longitudinally folded. Of the entire alimentary canal only a small part—the stomach—with the appended hepatic cæca, is of the nature of a mesenteron, the region in front being a stomodæum, and that behind a proctodæum.

The **heart**, with the aorta into which it is continued in front, is the only part of the blood-system with definite walls. It is an elongated tube, closed behind, open in front, running along the middle line of the abdomen and thorax immediately beneath the terga, enclosed in a pericardial sinus which, as in the Crayfish, is part of the hæmocœle. Internally the tube is divided by valves opening forwards into a number of chambers; its walls are perforated by a series of pairs of valvular apertures or *ostia*. Running from the wall of the heart to the terga are a series of segmentally-arranged fan-shaped bundles of muscles—the *alary muscles* (Fig. 533, *m.*). These fibres are partly inserted into the wall of the heart, the lumen of which they dilate, partly into a membrane underlying the pericardial sinus.

Respiration takes place through the instrumentality of a system of air-tubes or *tracheæ* (Figs. 504 and 505), opening on the surface at the *stigmata*, to which reference has already been made. These tracheæ form a richly ramifying system extending to all parts of the body. They possess a chitinous internal lining, supported by means of a spirally-wound, fibre-like thickening. By means of this system of air-tubes air is conveyed throughout the body to all parts, and there is thus ensured the rapid and



FIG. 503.—Right salivary gland and salivary receptacle of **Cockroach**. (After Miall and Denny.)

complete oxygenation which the functional activity of the Insect requires.

The **nervous system** consists of a *brain* (Fig. 502, *brn.*, and 506, *br.*), a *sub-oesophageal* pair of ganglia (*infr. gang.*), three *thoracic* (Fig. 506, *thor. 1, 2, and 3*) and six *abdominal* pairs of ganglia (the members of each pair being united), a system of *connectives* uniting the ganglia together, and a series of *nerves* given off to the various parts of the body. The brain consists of a bilobed mass of nerve-matter situated in the head, and divisible into two parts, anterior and posterior. From the anterior part is given off on each side the

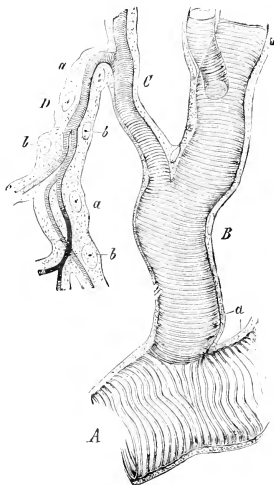

FIG. 504.—Portion of a trachea of a **Caterpillar**. *B, C, D*, branches; *a*, cellular layer; *b*, nuclei. (From Gegenbaur.)

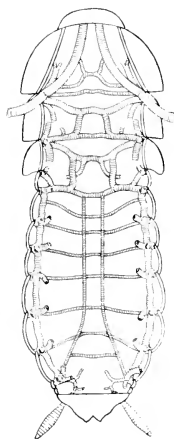

FIG. 505.—**Cockroach**. View of the arrangement of the principal trunks of the tracheal system. (After Miall and Denny.)

optic nerve passing to the eye to become expanded into an optic ganglion, and from the posterior part the nerves to the antennæ. It is supported by a chitinous framework—the *tentorium*. From the brain there run backwards a pair of *oesophageal connectives* (*conn.*), passing, one on each side of the *oesophagus*, downwards and backwards to the *sub-oesophageal ganglia*. The latter, which are situated between the *submentum* and *oesophagus*, give off a pair of connectives, passing backwards to the first *thoracic ganglia*. From the *sub-oesophageal ganglia* are given off the nerves to the *labrum*, the *mandibles*, and both pairs of *maxillæ*. The three pairs of *thoracic* and six of *abdominal ganglia* are connected together

into a chain by a series of double connectives; the last pair of abdominal ganglia, situated in the sixth segment of the abdomen (*abd6*), are larger than the others, and supply the segments behind. A *visceral nervous system*, ramifying on the anterior part of the alimentary canal, is connected with the two œsophageal connectives by two nerves, which join above the œsophagus to form a median *frontal ganglion*.

The organs of special sense are the eyes, the antennæ, and the palpi. The *eyes* are compound—each being made up of a large number of simple elements similar to those that go to make up the eye of *Apus* (see p. 523). The antennæ and palpi, together with the anal cerci, act as organs of touch. In addition, certain setæ on the antennæ appear to have an *olfactory* function.

Reproductive organs.—In the male the *testes* (Fig. 507, *test.*) are a pair of small bodies which lie in the fourth and fifth segments of the abdomen immediately below the terga. From these a pair of delicate tubes, the *vasa deferentia*, lead to the *vesiculæ seminales*, two tufts of whitish cæca, which together constitute what is known as the “mushroom-shaped gland”; these open into the anterior end of the *ejaculatory duct* (*duct. ej.*), an unpaired tube

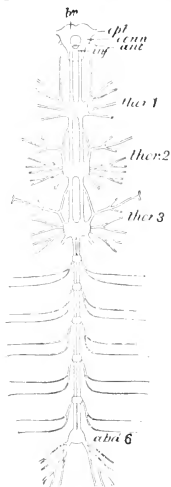

FIG. 506.—**Cockroach.** General view of the nervous system. *abd6*, sixth abdominal ganglion; *ant.* antennary nerve; *br.* brain; *conn.* œsophageal connective; *inf.* sub-oesophageal ganglion; *opt.* optic nerve; *thor.1, thor.2, thor.3*, first, second, and third thoracic ganglia. (After Miall and Denny.)

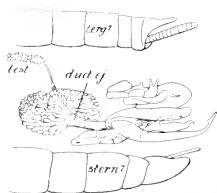

FIG. 507.—**Cockroach.** Male reproductive organs, lateral view. *duct. ej.* ductus ejaculatorius with mushroom-shaped gland; *stern. 7*, sternum of seventh segment of abdomen; *terg. 7*, tergum of the same segment; *test.* testis. (After Miall and Denny.)

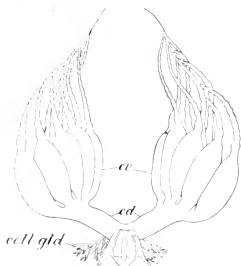

FIG. 508.—**Cockroach.** Female reproductive organs. *coll. gland.* colleterial glands; *od.* oviducts; *ov.* ovaries. (After Miall and Denny.)

with muscular walls opening on the exterior immediately below the anus. Around the genital aperture are a series of chitinous processes, the *gonapophyses*, which subservise copulation.

In the female there are two groups of *ovarian tubes* or *ovarioles*, each group or *ovary* (Fig. 508, *ov.*) consisting of eight. The ovarioles of each group are united together anteriorly, where they are connected by a ligament to the dorsal body-wall. Posteriorly each group is connected with a lateral *oviduct* (*od.*). Each ovarian tube has a beaded appearance, owing to its containing a row of ova, which increase in size posteriorly. The two oviducts unite to open by a median aperture on the sternal surface of the eighth segment of the abdomen. A pair of unsymmetrical sacs opening together in the middle of the sternum of the ninth segment constitute the *spermotheca* or *receptaculum seminis*. A pair of ramifying glandular tubules, the *colleterial glands* (*coll. gland.*), open behind the spermotheca. A series of chitinous *gonapophyses*, which aid in carrying the eggs, are situated between the female genital aperture and the anus.

Development.—The eggs are enclosed about sixteen together in chitinous capsules, the substance of which is secreted by the colleterial glands. They are laterally compressed, concave on one side (the future ventral side), convex on the other (the future dorsal side).

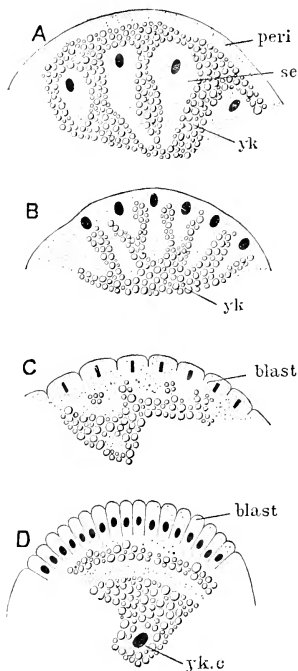

FIG. 509.—A—D, successive stages in the segmentation of the ovum of an **Insect**; *blast.* blastoderm; *peri.* peripheral protoplasm; *seg.* segmentation cells; *yk.* yolk; *y.k.c.* yolk-cells. (From Korscheil and Heider, after Blochmann.)

The mature egg in the lower part of the ovary is enclosed in a follicle composed of a single layer of cells, within which is the thin chitinous egg-shell or *chorion* perforated by a number of micropylar apertures. After the processes of maturation and fertilisation, the segmentation-nucleus undergoes division, the result being the formation of a number of irregular amœboid cells, which are

distributed through a considerable portion of the yolk. These (Fig. 509) all migrate to the surface, where they multiply rapidly and form a layer, the *blastoderm*, which becomes thickened along the ventral surface by the cells being elongated in a vertical direction. From the blastoderm a number of cells pass inwards into the substance of the yolk, where their function is to convert the yolk-material into various soluble substances for the nourishment of the blastoderm. The ventral thickening of the latter is the *ventral plate*: its cells proliferate, and the plate comes to be several cells thick: in front it becomes broader—an indication of the position of the future head-lobes. At the opposite end there is a specially thickened area of the ventral plate with a slight depression on its surface; the depression perhaps represents the blastopore, since it is from this point forwards that the formation of the mesoderm proceeds. The latter is formed as a longitudinal band which bifurcates in front in the position of the head-lobes.

The mode of origin of the endoderm in the Cockroach is not known with certainty. It appears beneath the mesoderm, in two separate portions, as a thin layer of cells—one portion, the anterior, coming into relation with the beginnings of the stomodæum, which arises as an invagination from the surface in the region of the head-lobes, and the other, the posterior, uniting with the proctodæum, a similar ectodermal invagination at the posterior end of the ventral plate. These two rudiments of the endoderm grow towards one another, and eventually meet to form a continuous layer destined to form the wall of the mesenteron. The ventral plate early becomes divided by a number of narrow transverse lines which indicate the boundaries of the future segments.

Rudiments of appendages (Figs. 510, 511) appear on the head and thorax, and a series also appears on the abdomen; all of the latter, however, subsequently disappear with the exception of the last pair, which give rise to the cerci. The segment on which the rudiments of the antennæ appear is at first post-oral in position, but subsequently becomes fused with a pre-oral segment (*prostomium*), so that the antennæ acquire their permanent pre-oral position only secondarily. The prostomial segment, the antennary segment, a segment devoid of appendages, the segment bearing the rudimentary mandibles, and those bearing the two pairs of maxillæ—six segments in all—unite to form the *head* of the adult.

Then follows the appearance of the *larval membranes*. On either side arises a fold of the blastoderm; and the two folds grow inwards and eventually unite over the body of the embryo, forming a complete two-layered covering for it. The outer layer is termed *serosa*, the inner *amnion*.¹

¹ This term is derived from one used in the Vertebrata, in which there is an analogous membrane, occupying, however, a dorsal instead of a ventral position as regards the body of the embryo.

Each of the two mesoderm bands undergoes transverse division into a series of segments (somites), which become hollow and are then closely applied to one another, eventually coalescing, so that the cavities of all of them unite to form the *coelome*, the outer walls becoming applied to the ectoderm to form a *somatopleure*, or lamina consisting of somatic layer of mesoderm and of ectoderm; the inner being applied to the endoderm to form a *splanchnopleure*, or lamina consisting of splanchnic layer of mesoderm and endoderm. When the two rows of somites, right and left, become approximated

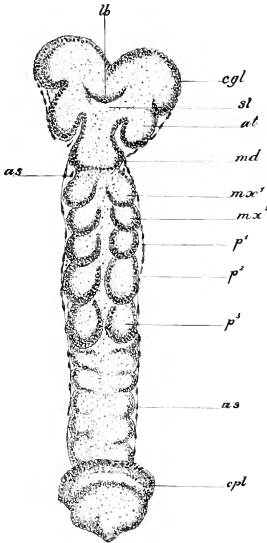

FIG. 510.—Ventral plate of embryo **Cockroach** (*Blatta germanica*), isolated from the yolk. *as*, amnion and serosa; *at*, antennary lobe; *cgl*, brain; *cpl*, caudal plate; *lb*, labrum; *md*, mandible; *mx*¹, *mx*², first and second maxillae; *p*¹, *p*², *p*³, legs. (After Wheeler.)

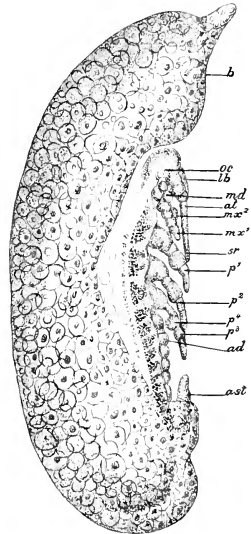

FIG. 511.—Embryo **Cockroach** just after the rupture of the amnion and serosa, lateral view of entire egg. Letters as in preceding figure. In addition, *at*, fatty body; *ast*, caudal styles; *b*, cephalic end of yolk; *oc*, eye. (After Wheeler.)

dorsally, special cells—the *cardioblasts*—separated off from them combine to form the wall of the tubular heart. Long before this is formed, however, the sides of the embryo are observed to undergo regular pulsations. The original *coelome*—the space between the *somatopleure* and *splanchnopleure*—has become converted into, or replaced by, a blood-sinus (*hæmocœle*), divided up into a number of smaller lacunæ containing plasma by films of connective tissue.

The ventral plate gradually grows upwards at the sides, and

eventually its borders meet and unite along the dorsal middle line, the entire yolk thus becoming enclosed by it.

The ventral nerve-chain is developed from a groove of the ectoderm, bounded by thickenings which become detached from the surface-ectoderm and form the chain of ganglia. The brain is developed from a pair of ectodermal thickenings. That part which is developed in the prostomial region—the *archicerebrum*—becomes united with that developed in the following two segments to form the completed brain or *syncerebrum*.

It can hardly be said that the Cockroach undergoes a metamorphosis, the young Insect when it escapes from the egg differing from the adult only in its smaller size and in the absence of wings, which grow out subsequently from the terga of the meso- and metathorax. Between its hatching and its complete development the young Cockroach undergoes no fewer than seven "moult" or *ecdyses*, in which all the chitinous parts become thrown off and renewed.

2. DISTINCTIVE CHARACTERS AND CLASSIFICATION.

The Insecta are air-breathing Arthropoda in which the body consists of three well-marked regions—head, thorax, and abdomen; the head devoid of external segmentation, nearly always bearing compound eyes, with a pair of antennæ situated on the prostomium, mandibles, and two pairs of maxillæ; the thorax of three segments each bearing a pair of legs, and the second and third usually bearing wings; the abdomen composed of a varying number of segments (7—11), which are devoid of appendages in the adult condition. A liver is absent, but salivary glands are always present. There is an elongated tubular heart, divided into eight chambers, situated in the abdomen; the vessels themselves are not highly developed. The Insecta are, almost without exception, air-breathers, and the organs of respiration take the form of branching tubes, the tracheæ, by means of which air is conveyed to all parts of the body. The nervous system and sense-organs reach a high level of complexity. The excretory organs are a number of blind tubes, the Malpighian tubes, appended to the intestine. The sexes are separate; development is sometimes direct, more usually complicated by metamorphosis.

Sub-Class I.—APTERYGOTA.

Insecta which are completely devoid of wings and pass through no metamorphosis.

ORDER 1.—THYSANURA.

Wingless Insecta with an abdomen of ten segments, more or fewer of which bear small appendages, and with two or three slender,

many-jointed cerci on the anal segment. Compound eyes and ocelli are sometimes present, sometimes absent. This order includes the "Silver-fish" (*Lepisma*, Fig. 512), and other genera—*Japyx*, *Machilis*, *Campodea*.

ORDER 2.—COLLEMBOLA.

Wingless Insecta with an abdomen of six or fewer segments, without paired appendages, but, in most cases, with a peculiar springing apparatus on the last or penultimate segment. Compound eyes never present. This order includes the Spring-tails (*Podura*, Fig. 513) and others.

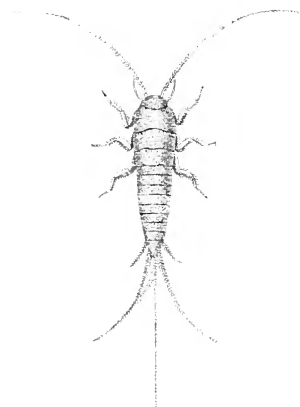

FIG. 512.—*Lepisma*. (After Guérin and Percheron.)



FIG. 513.—*Podura*. (After Guérin and Percheron.)

Sub-Class II.—PTERYGOTA.

Insects the great majority of which have wings in one or both sexes in the adult condition. A complete or incomplete metamorphosis.

ORDER 3.—ORTHOPTEROIDEA.

Insects with incomplete metamorphosis, with biting jaws, and with cerci of varying character at the extremity of the abdomen.

Sub-order 1.—Orthoptera.

Orthopteroidea in which there are two pairs of wings of which in most cases the anterior pair are harder and more opaque, the posterior pair more delicate and capable of being folded up like a fan beneath the anterior pair. The metamorphosis is incomplete.

In this sub-order are included a large number of families capable of being arranged in three main groups, viz.—(1) the *Saltatoria* or Leapers (Grasshoppers, Locusts, Fig. 514, and Crickets); (2) the

Gressoria or Walkers (Stick-and-Leaf Insects, Praying Insects); and (3) the *Cursoria* or Runners (Earwigs, Cockroaches).

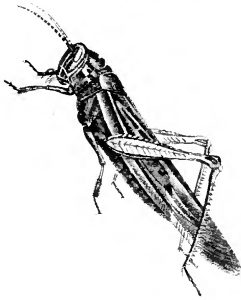

FIG. 514.—**Locusta**. (From Cuvier's *Animal Kingdom*.)

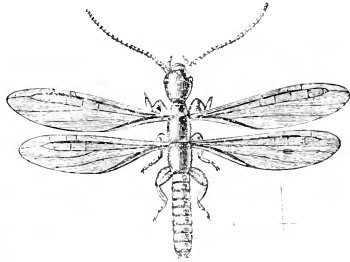

FIG. 515.—An **Embiid** (*Oligotoma michaelsi*) magnified. (From the *Cambridge Natural History*, after McLachlan.)

Sub-order 2.—Isoptera.

Orthopteroidea which form organised communities composed of soldiers, workers, and male and female sexual individuals. Membranous anterior and posterior wings are developed in the sexual individuals, but are soon thrown off.

This sub-order comprises only the Termites or "White Ants."

Sub-order 3.—Embiida.

Minute Orthopteroidea with rather long and narrow bodies (Fig. 515); winged or wingless—the wings when present membranous, not caducous but persistent. Communities are not formed.

Sub-order 4.—Psocida.

Minute Orthopteroidea with comparatively short thick bodies, slender antennæ, and usually with delicate membranous wings, the anterior pair the larger.

This sub-order (Fig. 516) includes Book-lice and Death-watches.



FIG. 516.—A winged Psocid (**Psocus fasciatus**), magnified. (From the *Cambridge Natural History*, after McLachlan.)



FIG. 517.—One of the **Mallophaga** inhabiting the common fowl. (From the *Cambridge Natural History*, after Piaget.)

Sub-order 5.—Mallophaga.

Small, flat, wingless Orthopteroidea with very slight metamorphosis, with biting mouth-parts.

This sub-order comprises only the Biting Lice or Bird Lice (Fig. 517), which are external parasites of birds and mammals.



FIG. 518.—*Ephemera* (May-fly) and larva. (After Guérin and Percheron.)

ORDER 4.—NEUROPTERA.

Pterygota with two pairs of membranous wings. The larvæ live in water.

This sub-order includes the Perlidæ, the Dragon-flies (*Odonata*), the May-flies (Fig. 518), the Ant-lions and the Caddis-flies.

ORDER 5.—THYSANOPTERA.

Insects with slight metamorphosis, with sucking mouth-parts, and usually with four narrow fringed wings.

This order comprises the insects, usually of very small size, known as Thrips.

ORDER 6.—HEMIPTERA (RHYNCHOTA).

Insects in which wings are usually present, sometimes similar, sometimes dissimilar, and in which there is a jointed suctorial

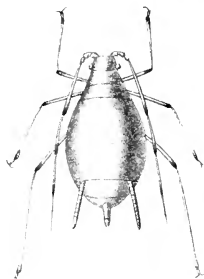

FIG. 519.—*Aphis rosæ* and larva. (From Cuvier's *Animal Kingdom*.)

rostrum formed from the labium, enclosing the jaws in the form of piercing organs. The prothorax is free from the other segments of the thorax. The metamorphosis is incomplete.

This order includes Bugs, Water-bugs, Scale-insects, Plant-lice (Fig. 519), and Cicadas (Fig. 520). Lice (*Anoplura*), wingless parasites of mammals, are usually looked upon as degenerated members of the Hemiptera.



Fig. 520.—**Cicada**. (After Guérin and Percheron.)

ORDER 7.—DIPTERA.

Insects provided (except in the Fleas) with a single pair of transparent membranous wings, representing the anterior pair of other orders. The mouth-parts are

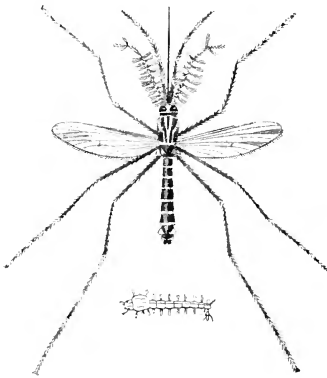

Fig. 521.—**Culex** (mosquito) and larva. (After Guérin and Percheron.)

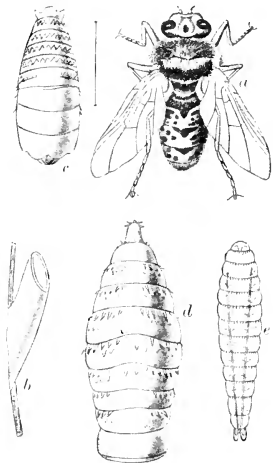

Fig. 522.—Bot-fly of the horse (**Gastrophilus equi**). *a*, mature insect; *b*, egg attached to a hair; *c*, *d*, and *e*, stages in the larval development. (After Brehm.)

adapted for piercing and sucking. The prothorax is fused with the other segments of the thorax. There is a complete metamorphosis.

This order includes Gnats and Mosquitoes (Fig. 521), House-flies

and Blow-flies, Bot-flies (Fig. 522), Crane-flies, and "Daddy-long-legs," to which may be added the greatly modified, wingless, parasitic group, the Fleas.

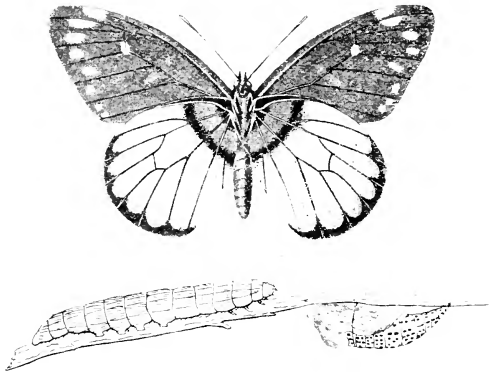

FIG. 523.—Butterfly (*Pieris*), with caterpillar and chrysalis stages. (After Guérin and Percheron.)

ORDER 8.—LEPIDOPTERA.

Insects with both pairs of wings well developed and covered with scales (modified hairs). The maxillæ are modified to form an elongated sucking tube, which can be rolled up spirally; the other parts of the mouth are rudimentary, with the exception of the labial palpi. The prothorax is fused with the mesothorax. The metamorphosis is complete.

This order includes Butterflies (Fig. 523) and Moths.



FIG. 524.—Beetle (*Crioceris*), with larva. (After Guérin and Percheron.)



ORDER 9.—COLEOPTERA.

Insects in which the anterior pair of wings take the form of hard horny wing-cases, or *elytra*, which, when at rest, are folded up along the back and cover over the folded-up membranous posterior wings. The prothorax is movable on the other segments. The jaws are fully developed, and adapted for biting and chewing. The metamorphosis is complete.

This order includes the true Beetles (Fig. 524).

ORDER 10.—MECOPTERA.

Insects with four elongated membranous wings (sometimes rudimentary or absent). The mouth-parts are adapted for biting and are borne at the end of a deflexed rostrum. The larvæ are caterpillar-like with numerous pro-legs and are carnivorous.

This order includes the Scorpion-flies (Fig. 525).

ORDER 11.—HYMENOPTERA.

Insects in which both pairs of wings are present and membranous. The mouth-parts are adapted both for biting and licking. The prothorax is united with the other segments of the thorax. There is a complete metamorphosis.

Included in this order are Bees (Fig. 541) and Wasps, Ants (Fig. 542), Gall-flies, and Ichneumons.

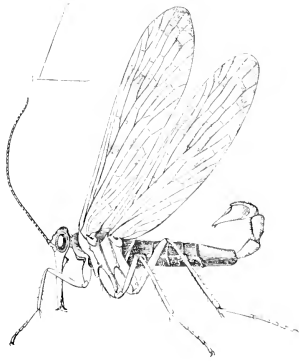

FIG. 525.—A Scorpion Fly (*Panorpa communis*), male. (After Sharp.)

Systematic Position of the Example.

The Cockroach is a member of the order *Orthoptera*, of which there are three divisions, the *Cursoria*, to which the Cockroaches belong; the *Gressoria*, comprising the *Mantida* and *Phasmida*, or Stick-and-Leaf insects and their allies; and the *Saltatoria*, including the Grasshoppers, Locusts, and Crickets. The division *Cursoria* comprises, in addition to the Earwigs, the single family of the Cockroaches (*Blattida*), characterised by the deflexed head, the flat oval body, the large prothoracic tergum, the long antennæ, the three pairs of legs similar, with large coxæ entirely covering the sternal surface of the thorax, the five-jointed tarsi, and the presence of anal cerci. *Periplaneta* belongs to a section of the family distinguished from the rest by the femora being spiny underneath, and by the valvular character of the last sternum in the female.

3. GENERAL ORGANISATION.

The **exoskeleton** of the Insecta (Fig. 526) consists of a chitinous cuticle (*cut.*), which varies in hardness and thickness in different Insects and in different parts of the body of the same Insect, but is very rarely calcified. Frequently it presents hexagonal markings; sometimes it is perforated by numerous pores; sometimes it is

covered with thin scales; in many cases it is developed into *tactile hairs* or *setæ*, which may be scattered over the body, or may be located only on certain of the appendages—the antennæ, the maxillary and labial palpi, and the tarsi of the legs. In some, *glands* are present in the integument—odoriferous, honey-secreting, or wax-forming glands; poison glands are present in connection with an abdominal sting in certain Insects; spinning glands, forming a silky material, are confined to the larvæ.

FIG. 526.—Section through the integument of an Insect. *base*, basement membrane; *cut.*, layers of the cuticle; *epi.*, epidermis; *set.*, seta. (After Miall and Denny.)

The head presents no trace of segmentation, but the history of its development indicates that it may be looked upon as composed of a prostomium and about five segments, intimately united together. It varies a good deal in shape, but always presents the regions that have already been described in the case of the Cockroach. Of these the *epicranium* is the most extensive; the *clypeus*, situated in front of it, supports the labrum; the *genæ* are situated laterally, and a median piece, the *gula*, occupies the middle of the ventral surface. Sometimes the head is sunk within the anterior part of the thorax; sometimes it is free from the latter; and there may be, as in the Cockroach, a short narrow region or *neck*, covered with soft skin, supported only by isolated *cervical sclerites*, on the ventral aspect.

The three segments of the **thorax**—*pro-*, *meso-*, and *metathorax*—are usually firmly united together; but in some Insects the prothorax is movable upon the other segments: it is usually the smallest of the three segments. In each the

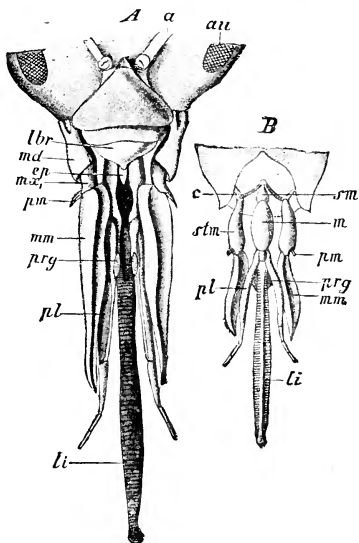

FIG. 527.—A, mouth-parts of the Honey-bee (*Apis mellifica*); B, the two pairs of maxillæ. *au.*, eye; *a.*, antenna; *c.*, cardo; *ep.*, epipharynx; *lbr.*, labrum; *li.*, ligula; *m.*, mentum; *mm.*, *mx.*, first pair of maxillæ; *md.*, mandible; *pl.*, labial palpi; *pm.*, palp of the first pair of maxillæ; *prg.*, paraglossa; *sm.*, submentum; *stm.*, stipes of the first maxillæ. (From Lang.)

exoskeleton consists of *dorsal* or *tergal* and *ventral* or *sternal* elements, sometimes separate from one another laterally, sometimes united together in such a way as to form complete rings round the segments. Laterally projecting processes or *pleura* are sometimes developed.

The **abdomen** contains from seven to eleven segments, enclosed in tergal and sternal shields. In some Insects the first abdominal segment is united with the thorax so as to appear to belong to the latter region.

The **appendages of the head** are four pairs, as in the Cockroach; but a considerable variation is observable in the different

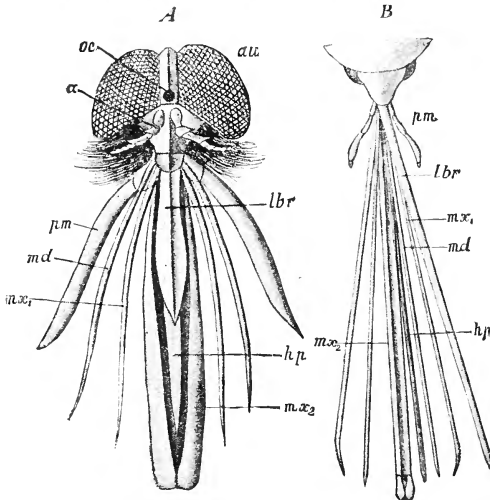

FIG. 528.—Mouth-parts of the Diptera. A, of **Tabanus**; B, of **Culex**. Lettering as in preceding figure: *hp*, hypopharynx; *oc*, ocellus. (From Lang.)

orders, especially as regards the jaws. In certain of the Aptera an additional pair—the so-called *maxillulæ*—occur between the mandibles and first maxillæ. In a few eyes are absent. Most have large compound or faceted eyes, and many have simple eyes or ocelli as well; in a few groups the latter are alone present. The antennæ vary in shape in different groups and sometimes even in the sexes of the same species. They may be tapering, moniliform, club-shaped, pectinate, or plume-like. In addition to functioning as tactile appendages they bear the olfactory setæ, and there seems reason to believe that they act also as organs concerned in the maintenance of the equilibrium of the body. The

mandibles are always one-jointed, and differ from those of the Crustacea in never being provided with a palp. An arrangement of the mouth-parts adapted for biting or chewing has already been described in the case of the Cockroach: this type is characteristic of the order Orthoptera, to which the Cockroach belongs, and a very similar type characterises the Coleoptera. In the Hymenoptera (Fig. 527) the mouth-parts are adapted both for biting and for licking; the mandibles (*md.*) and maxillæ (*mx.*₁) are sharp and lancet-like; the middle part of the labium is produced into a long median tongue (*ligula*, *li.*) at the sides of which are a pair of

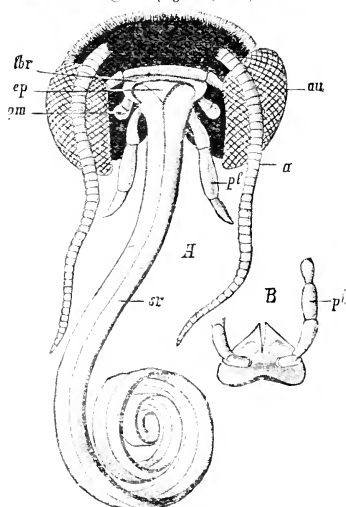

FIG. 529.—Mouth-parts of the **Lepidoptera**. *B*, the second maxillæ. Lettering as in preceding figures: *pl*, labial palp; *pm*, palp of the anterior maxillæ; *sr*, sucking tube. (From Lang.)

accessory tongues or *paraglossæ* (*prg.*). In the Hemiptera there is a proboscis formed from the labium and enclosing the stylet-like mandibles and maxillæ. In the Diptera (Fig. 528) the mandibles (*md.*), usually not developed in the males, are biting or piercing organs, while the basal parts of the labium form a proboscis (*mx.*₂) enclosing a spine or seta (*hp.*)—which is a process from the *hypopharynx*—and sometimes stylet-like maxillæ (*mx.*₁). In the Lepidoptera (Fig. 529) the mandibles are aborted in the adult, and the maxillæ are developed into elongated half-tubes, which when applied together form a complete tube (*sr.*) capable of being coiled up in a spiral manner under the head, the

extremity provided with hooks or spines for rupturing the nectaries of flowers.

Appendages of the thorax.—Each of the segments of the thorax bears a pair of five-jointed legs; the terminal section or tarsus being made up of a number of short segments, usually five, and ending in a pair of claws, often with an adhesive pad or sucking disc between them, or in a single claw. In accordance with variations in the uses to which they are put, considerable differences are observable in the form of the legs in different groups of Insects. In most they are adapted for walking, and are long and slender; in some they are expanded to enable them to act as swimming

paddles; in some the first pair are prehensile, and develop a subchelate extremity; in others, again, the legs, or the first pair of them, are stout and adapted for burrowing. In addition to the legs the meso- and metathorax may each bear a pair of *wings*. The wings are thin transparent expansions of the integument of the body, supported by a system of branching ribs or *nervures* consisting of chitinous material with branches of the trachea, nerves, and tubular diverticula of the body-cavity. In most Lepidoptera the wings are opaque, owing to their being covered with numerous overlapping microscopic scales, to which the various colours of the wing are due. In some insects—*e.g.*, Beetles and Orthoptera—the posterior wings alone are delicate and membranous, the anterior pair being converted into hard or tough cases—the *elytra*—which when folded up cover over and protect the delicate posterior wings. In some Beetles the elytra are permanently united together along the back of the Insect. In some Insects (Bugs) the anterior wings are chitinous at the bases only. In the Diptera the anterior wings alone are developed, the posterior being represented by vestiges—the *halteres* or balancers. In the Strepsiptera, or Bee-parasites, an aberrant group of Neuroptera, on the other hand, it is the anterior pair that are vestigial. In some Insects (Spring-tails, Lice, Fleas) wings are entirely absent in all stages. In others again they are present in one sex—usually the male—and absent or vestigial in the other. In the Aptera there is no vestige whatever of wings at any stage, and this, taken in connection with the simplicity of the structure in other respects, seems to indicate that in these Insects we have to do with the descendants of a primitive group in which wings had not yet become developed.

The segments of the **abdomen** are mostly devoid of paired appendages in the adult condition (except in the Thysanura), though vestiges of them may be present in the young at an early stage. Each segment is enclosed in dorsal *tergal* and ventral *sternal* plates, which usually remain separate laterally, but may be united. At the extremity of the abdomen there are frequently appendages which are perhaps of the nature of limbs, having the function of stings, ovipositors, and genital processes.

Hæmocœle.—The cavity intervening in an Insect between the body-wall and the various internal organs does not correspond, as already explained (p. 578), to the cœlome of other groups, but is found, when we study its mode of development, to be a *hæmocœle*—an extended part of the blood-vascular system. The cœlome is apparently represented only by the lumen of the reproductive organs.

A **fat-body** is always present, either in the larval condition or throughout life. It consists of a mass of polygonal cells bounding the hæmocœle externally. When young the cells are nucleated and possess a protoplasmic body. At a later stage a fluid loaded with minute granules takes the place of the protoplasm, and

crystals containing uric acid are formed. These crystals afterwards become absorbed; their appearance and subsequent absorption would seem to point to the probability that the fat-body is concerned in separating out nitrogenous waste matters, which subsequently reach the exterior through the Malpighian tubes. Its chief function is to serve as a reserve-store of nutrient material.

Digestive system.—Some Insects do not feed in the adult condition, and when this is the case the mouth may be absent,

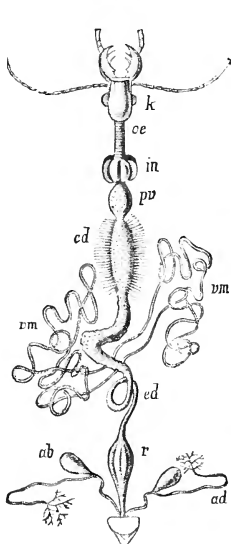

FIG. 530.—Digestive apparatus of a Beetle (*Carabus auratus*). *ad*, anal glands; *ab*, their muscular appendages; *cd*, stomach; *ed*, hind gut; *in*, crop; *k*, head with mouth-parts; *ae*, oesophagus; *pv*, proventriculus; *vm*, Malpighian tubes. (From Lang, after Dufour.)

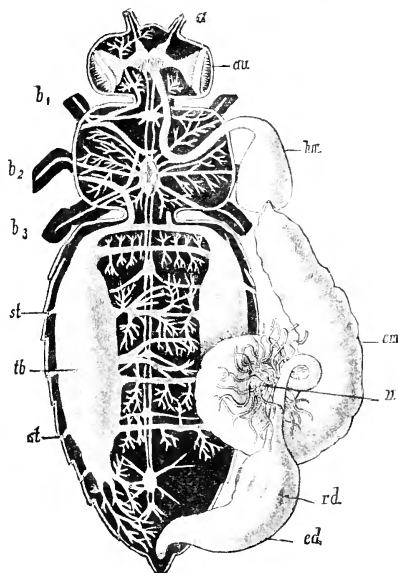

FIG. 531.—Nervous, tracheal, and digestive systems of the Honey-bee. *a*, antenna; *au*, compound eye; *b*₁, *b*₂, *b*₃, the three pairs of legs; *cm*, stomach; *ed*, hind gut; *hm*, honey stomach (crop); *rd*, rectal glands; *st*, stigmata; *tb*, vesicle of tracheal system; *vm*, Malpighian vessels. (From Lang's *Comparative Anatomy*.)

as, for example, is the case in the Day-flies (*Ephemera*). When a mouth is developed, as it is in the vast majority of Insects, it is situated on the lower aspect of the head, bounded in front by the labrum, and behind by the labium. It leads into the buccal cavity or pharynx, into which open the ducts of a pair of *salivary glands*, each of which often has associated with it a thin-walled sac or *salivary receptacle*. Also in the neighbourhood of the mouth in such larval Insects as spin a cocoon, the ducts of a pair of

spinning glands open. A projection of the roof of the mouth-cavity (*epipharynx*) is present in some Insects; in others it is replaced by a projection from the floor, the *hypopharynx* or *lingua*.

The alimentary canal is nearly always considerably longer than the body; it is longer in vegetable-feeding than in carnivorous forms. The pharynx leads into a long, narrow passage—the *œsophagus* (Figs. 530 and 531 *æ.*)—which dilates behind into a *crop* (*in*) for the storage of food. The place of this in sucking Insects is taken by a stalked sac, usually termed the *sucking stomach*. The essential processes of digestion are carried on in an elongated chamber with glandular walls—the *stomach* (*cd*)—which may be divided into several parts. Sometimes between the crop and stomach is intercalated a muscular-walled chamber, frequently containing chitinous teeth, the *proventriculus* or *gizzard* (*pv*). Appended to the stomach at its anterior end are, in many Insects, a varying number of tubular blind pouches, the *hepatic cæca*. At its junction with the small intestine there open a number (from 2 to over 100) of narrow tubular appendages, the *Malpighian tubes* (*vm*), which are the organs of renal excretion. In the cases in which the development of the alimentary canal has been traced, it has been found that the Malpighian tubes mark the point where the mesenteron passes into the proctodæum, and it is assumed that this holds good generally. The lumen of the tubes is sometimes filled up with cells. In some insects, the Malpighian tubes open into a paired or unpaired sac—the *urinary bladder*. The intestine is usually elongated, and its posterior portion (*ed.*) is dilated to form a wide *rectum* (*r.*), which opens on the exterior by an anal aperture situated on the ventral side of the last segment of the abdomen. *Anal glands* (*ad.*), producing an odoriferous secretion, often open into the rectum.

The **tracheal system** (Fig. 531) communicates with the exterior through a number of apertures—the *stigmata* (*st*)—which vary in the details of their arrangement in the different orders. They are always protected against the entry of foreign particles by some means—either by being surrounded by special bundles of hairs, or by being provided with a special sieve-like membrane. In most cases they are capable of being closed by muscular action. In some Insects, mainly those adapted for active flight, such as the Hymenoptera, the tracheal system is dilated in certain parts of the body to form comparatively large *air-sacs* or *air-reservoirs* (*tb*). In the aquatic larvæ of some Insects there is a series of soft external, simple or divided, processes—the *tracheal gills* (Fig. 532)—attached to the abdominal segments and richly supplied with tracheæ, which have no communication with the exterior; in others *rectal gills* are developed—soft lamellæ on the inner surface of the rectum.

The **blood-vascular** system is, in comparison with the other systems of organs, not very highly developed, the need of an

elaborate system of vessels being greatly diminished by the way in which all the tissues and organs are supplied with oxygen through the system of tracheæ. The blood is colourless or faintly yellowish or greenish, and contains colourless corpuscles. A contractile *dorsal vessel* or *heart* (Fig. 533) extends through the abdomen—and sometimes the thorax—immediately below the terga. Its cavity is divided internally into a series of chambers by a system of valves. In its walls are a series of slits or *ostia*, by which a communication is effected between the internal cavity and a surrounding *pericardial sinus*. Alary muscles, fan-shaped bundles of fibres, arise from the terga and are in part inserted into the heart, causing or assisting in causing its dilatation and the opening of the *ostia*. In front the heart gives origin to a main vessel, or *aorta* (a).

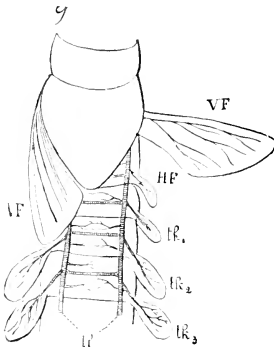

FIG. 532.—Thorax and anterior abdominal segments of a larval **Ephemeroptera** with tracheal gills. *HF*, hind-wings; *tk₁*, *tk₂*, *tk₃*, tracheal gills; *lt*, longitudinal tracheal trunks; *VF*, fore-wings. (From Lang's *Comparative Anatomy*.)

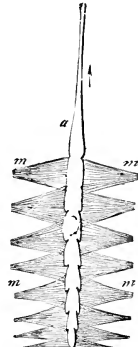

FIG. 533.—Heart of Cockchafer (**Melolontha**). *a*, aorta; *m*, *m*, alary muscles. (From Gegenbaur.)

The **nervous system** (Figs. 531 and 534) is on the same general plan as in the Crustacea. There is a double *supra-oesophageal ganglion* or *brain*, a *sub-oesophageal ganglion*, also double, and a series of *thoracic* and *abdominal pairs of ganglia*, which are closely united together in the middle line. The brain is relatively large in the higher Insects, and is divided into several lobes. It gives off nerves to the antennæ, the ocelli and the labrum, and on each side arises a large lobe—the *optic ganglion*—on which the compound eye rests. A pair of *oesophageal connectives* pass backwards on either side of the mouth from the brain to the sub-oesophageal ganglion. These connectives are usually very short, and, as a consequence, the brain and sub-oesophageal ganglia are closely approximated. From the latter there originate nerves to the appendages of the mouth—the mandibles and the two pairs of maxillæ. There are sometimes three

pairs of thoracic and as many as eight of abdominal ganglia in the adult insect ; but in many cases there is a greater or less degree of concentration of the ventral ganglionic chain (Fig. 534), and in some of the Diptera this reaches such an extreme that all the ventral ganglia, with the exception of the sub-oesophageal, are united into one elongated mass. The Insects, like the higher Crustacea, possess a *visceral* or *sympathetic* nervous system, connected with the oesophageal connectives, and passing backwards on the oesophagus and crop.

The most highly developed **organs of special sense** are the large compound *eyes*. The surface of the compound eye is marked

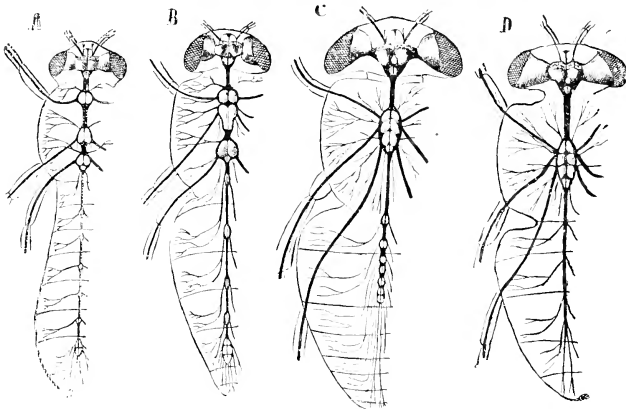

FIG. 534.—Nervous systems of four species of Diptera to illustrate various degrees of concentration. *A*, non-concentrated nervous systems of **Chironomus plumosus** with three thoracic and six abdominal ganglia ; *B*, nervous system of **Empis stercorea** with two thoracic and five abdominal ganglia ; *C*, nervous system of **Tabanus bovinus**, with one thoracic ganglion and with the abdominal ganglia closely approximated ; *D*, nervous system of **Sarcophaga carnaria**, with all the ganglia of the ventral chain united together with the exception of the sub-oesophageal. (From Lang's *Comparative Anatomy*.)

out, as in the case of the Crayfish, into a great number of minute hexagonal facets, each of which indicates one of the elements (*ommatidia*) of the eye. Of these there may be as many as 28,000 (Dragon-fly). When the eye is examined in section, each *ommatidium* is found to consist of a *cornea-lens*—the outer surface of which forms the facet—a *crystalline cone*, and a *rhabdome*. The crystalline cone is not always developed, its place being taken in the eyes of some Insects by four *crystal cells*. The rhabdome is an elongated rod. Beneath the rhabdome is a *fenestrated membrane*, beneath which, again, is a dense plexus of nerve-fibres. Nerve-fibres pass through the fenestrated membrane and terminate in a delicate sheath which encloses each rhabdome, the sheath, together

with the nerves that end in it, constituting the *retinula*. Pigment surrounds the crystalline cones and retinulæ.

The *ocelli*, or simple eyes (Fig. 535), consist of a biconvex transparent thickening of the cuticle—the *lens*—and beneath it of a group of specially modified epidermal cells. Some of these, situated beneath the lens, form a transparent mass, the *vitreous body*, another set of elongated cells being arranged to form the *retina*.

The antennæ and palpi are the *organs of touch*, and these appendages seem to be also the seat of the *olfactory sense*. A number of minute processes sometimes sunk in pits, and each having a special nerve-plate connected with it, are regarded as being specially concerned with this sense; and similar processes or pits on the maxillæ and the epipharynx are perhaps connected with the *sense of taste*. The results of experiments on the action of the antennæ seem to

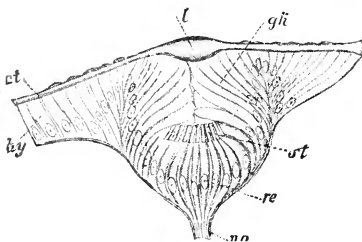

FIG. 535.—Section through the ocellus of a young *Dytiscus* larva. *ct*, cuticle; *gk*, cells of the vitreous body; *hk*, epidermis; *l*, cuticular lens; *no*, optic nerve; *re*, retinal cells; *st*, rods. (From Lang, after Grenacher.)

lead to the conclusion that one of their main functions is to act as organs for regulating the equilibrium of the body.

Peculiar nerve-endings, supposed to be *auditory*, occur in various parts of the body. These are distinguished as *chordotonal* or *tympanic*, according to the nature of that part of the apparatus which functions by vibrating in response to the sound-vibrations. In the chordotonal organs this is a tense thin chord; in the tympanic a tense membrane or *tympanum*. The name of Johnston's organs is given to auditory organs of a tympanic type which occur in the second segment of the antennæ in the majority of insects.

In certain Insects—the Fireflies and Glow-worms, belonging to the order Coleoptera—occur **luminous organs** for the production of light.

Sounds are emitted by many Insects, and are produced by a variety of different means. Often the sound is the result of the rubbing together of opposed rough surfaces of the integument. The chirp of the Grasshopper, for example, is produced by the rubbing of the femur of the last pair of legs over a series of ridges on the anterior wing, and that of the Locust by the rubbing against one another of the roughened basal parts of the first pair of wings. In other cases the sound results from the rapid vibratory movement of the wings; this is the case with the buzzing of many

Diptera and Hymenoptera. Again, the humming sounds characteristic of many of the last-named order are produced partly by the vibrations of the wings in flight, partly by the vibration of leaf-like appendages in the tracheæ set in motion by strong expiratory currents of air. The loud shrill note of the Cicada is produced by the rapidly recurring contractions of the fibres of a muscle inserted into a stiff chitinous membrane, the result being a series of crackling sounds, which follow one another so rapidly as to give rise to a continuous note.

Reproductive organs.—The sexes are always separate in Insects, as in Arthropoda in general; and the males and females are very commonly distinguishable from one another by various modifications of

form and of coloration. There are two ovaries, each of which consists of a greater or smaller number of narrow tubes or ovarioles; in each of these the ova are arranged in a single row—the early stages in their formation being situated at the anterior end, the more mature ova towards the posterior extremity. Each group of ovarian tubes opens into a lateral oviduct,

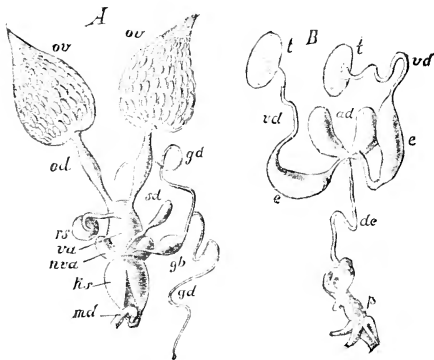

FIG. 536.—A, female and B, male sexual apparatus of the **Honey-bee**: *ad*, accessory glands; *de*, common ejaculatory duct; *gd*, poison-glands; *gb*, poison-vesicle; *ks*, bulb of the stinging apparatus; *md*, rectum, twisted back and cut off; *nva*, accessory sac of the vagina (bursa copulatrix); *ol*, oviduct; *ov*, ovary; *p*, penis; *rs*, receptaculum seminis; *sd*, colleterial gland; *t*, testes; *va*, vagina; *vd*, sperm-ducts. (From Lang's *Comparative Anatomy*.)

and the two lateral oviducts, right and left (Fig. 536, A, *ol*.), in most cases unite behind to form a median oviduct or vagina (*va*.), which opens towards the posterior end of the abdomen. Connected with this median oviduct, or opening close to it, are *receptacula seminis* (*rs*.) and *colleterial* or *cement-glands* (*sd*.). Sometimes there is a copulatory sac, or *bursa copulatrix* (*nva*.). In the male the paired *testes* (B, *t*.) vary greatly in form: sometimes each is a long, narrow tube; sometimes several such tubes combine to form the testis; or it may be of more compact rounded form and entire or lobed. Each testis has a slender duct or *vas deferens* (B, *vd*.), the two *vasa deferentia* uniting to form a median *ejaculatory duct*. A *vesicula seminalis* is appended to each *vas deferens* or to the

ejaculatory duct. Accessory glands, opening into the vas deferens or the ejaculatory duct, secrete cementing material for uniting the sperms into masses, the *spermatophores*. In most instances the eggs are laid shortly after their fertilisation, only a comparatively few forms, such as the *Aphides* or Plant-lice, many Diptera, and some Coleoptera, being *viviparous*. Some Insects, such as the Aphides and the Bees and Wasps, as well as some Lepidoptera and Neuroptera, present us with the unusual phenomenon of *parthenogenesis*; *i.e.*, ova are formed, as in ordinary female insects, in organs corresponding to the ovaries of the latter, and are developed without fertilisation. In the case of the Aphides, an autumn generation of completely-developed males and females is followed by a spring generation consisting entirely of females; these are both parthenogenetic and viviparous. In the Bees, the workers (imperfectly developed females) occasionally produce ova which, without fertilisation, develop into drones (males). In a few species of one or two groups, including the Scale-Insects (*Coccidæ*) and Gall-Insects (*Cynipidæ*), males are never developed, so that reproduction is exclusively parthenogenetic. *Pædogenesis* accompanies parthenogenesis in certain Diptera; *i.e.*, the *larvæ* or *pupæ* produce ova and embryos without impregnation.

The eggs when laid are protected from injury by a number of methods; they may be firmly fixed to the substratum, buried in the earth, or laid in the interior of certain plants or even of animals. The deposition of the eggs, by means of ovipositors, in the leaves or other parts of plants gives rise to swellings—the so-called *galls*, in the interior of which the young Insects live. In the case of many Insects the eggs are enclosed in a cocoon; in others they are surrounded by gelatinous or waxy material. The eggs are, for the most part, of relatively considerable size. In form they vary, but the long oval prevails in most instances. The ripe egg is enclosed in two egg-membranes—an inner, the *vitelline membrane*, produced by the egg itself, and an outer, the *chorion*, formed from the follicle-cells. The chorion, which usually exhibits a more or less elaborate pattern, has one or more apertures or micropyles for the entry of the sperm. The contents are distinguishable into two layers—a superficial, consisting of protoplasm, and a central, of nutrient yolk.

Development.—The segmentation is usually of a type already referred to (p. 581) as very common among the Crustacea, *viz.*, *superficial* segmentation. The actual segmentation (Fig. 537) has chiefly been observed in the case of certain Insects with very little yolk; but there can be very little doubt that in ordinary forms with abundant yolk the process is in essence the same. The segmentation-nucleus, originally situated near the middle of the ovum, divides into a number of nuclei, and most or all of these migrate towards the surface, and arrange themselves in the form

of a sphere almost parallel with the latter; eventually they reach the peripheral protoplasm at the surface, which then becomes divided into cell-areas corresponding with the nuclei. The layer of cells thus formed constitutes the blastoderm. This

the latter; eventually they

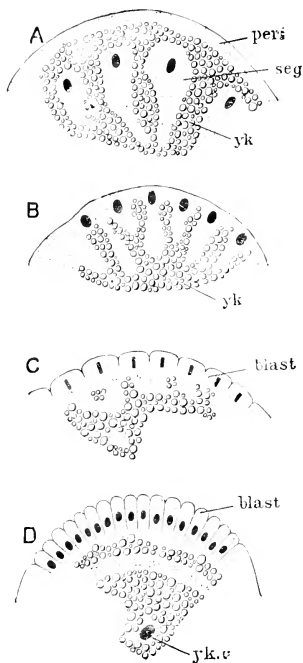

FIG. 537.—A—D, successive stages in the segmentation of the ovum of an **Insect**. *blast*, blastoderm; *peri*, peripheral protoplasm; *seg*, segmentation-cells; *yk*, yolk; *ykc*, yolk-cells. (From Korschelt and Heider, after Blochmann.)

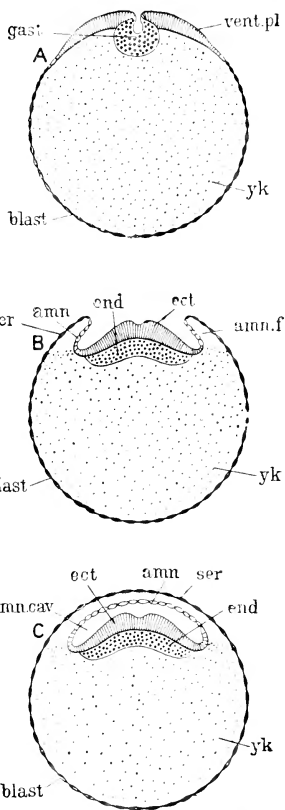

FIG. 538.—A—C, transverse sections through the developing ovum of an **Insect** at successive stages to show the mode of development of the germinal layers and of the amnion. *amn*, amnion; *amn. f.*, fold of the amnion; *amn. cav.*, cavity of the amnion; *blast*, blastoderm covering the yolk; *ect*, ectoderm; *end*, endoderm; *gast*, invagination of ventral plate; *ser*, serosa; *vent. pl.*, ventral plate; *yk*, yolk. (After Korschelt and Heider.)

thickens along one side to form the *ventral plate*, as already described in the case of the Cockroach (p. 613), and the changes which this

structure undergoes, together with the mode of formation of the appendages, are similar in most members of the class, except that in most Insects the formation of the mesoderm and endoderm is associated with a more or less distinct invagination (Fig. 538). The same holds good of the formation of the amnion and the further development of the mesoderm and endoderm. In some cases there is developed between the serosa and the true amnion a space filled with yolk, and the ventral plate appears sunk within the yolk. The nervous system is developed from the ectoderm in the manner indicated in the account of the Cockroach (p. 615). The tracheal system is derived from a series of pairs of segmentally arranged ectodermal involutions (Fig. 540, *st*).

Metamorphosis.—In some instances the young Insect, when it escapes from the egg-membranes, has exactly the form of the

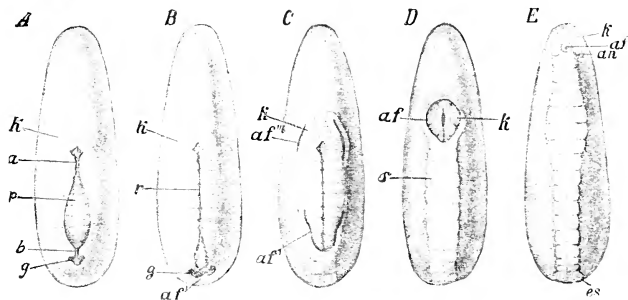

FIG. 539.—A—E, ventral view of five stages in the development of *Hydrophilus*. *a* and *b*, points at which the blastopore first closes; *af*, edge of the amnion fold; *af'*, caudal fold; *af''*, paired head-fold; *an*, antenna; *es*, terminal segment; *g*, pit-like invagination to form the rudiment of the amnion cavity; *k*, procephalic lobes; *r*, groove-like medio-ventral invagination; *s*, germinal bands covered by the amnion. (From Lang, after Heider.)

parent, except that, as a rule, the wings have not yet grown. But in most cases there is a metamorphosis. In some this is comparatively slight and gradual, the adult Insect differing from the larva only in comparatively unimportant points, and the segments and appendages of the latter becoming directly converted into those of the former. Such a metamorphosis, in which there is no quiescent stage, is said to be *incomplete*. The term *complete* is applied to the metamorphosis of the majority of Insects, in which the larva differs so completely from the *imago*, or perfect Insect, in external form, the nature of the appendages, and the internal organisation, that there is need of a quiescent or *pupa* stage, during which the whole animal, or a considerable part of it, undergoes an entire transformation. The metamorphosis is complete in the Diptera, Lepidoptera, Coleoptera, and Hymenoptera, absent or incomplete in the other orders. In many Diptera the body of the

larva or "maggot" is completely worm-like, without any appendages, and without any distinct head. In other cases (Lepidoptera, &c.) there is a distinct head; the three thoracic segments have three pairs of jointed legs, and the abdominal segments short unjointed *pro-legs* (Fig. 523). In most instances the larvæ differ widely from the adults in their food and mode of life; very generally the jaws are adapted for biting, even when the mouth of the adult is suctorial. After a longer or shorter period passed in this larval condition, in which it is usually active and very voracious, the young Insect passes into a quiescent or *pupa* stage, during which it remains passive, enclosed in a tough integument, while a more or less complete reconstruction of the organs goes on, resulting in the development of all the parts of the perfect Insect. The development of the new parts takes place from certain patches of cells, the *imaginal discs*, present in the larva.

In the Diptera the larva or maggot is sometimes completely devoid of jaws. In some Diptera, however, the jaws are well developed, and there is a distinct head. After frequent moultings the maggot passes either into a quiescent or pupa stage enclosed in a hard skin, or into the stage of an active *aquatic pupa*, which swims about actively in water and may possess tracheal gills.

In the Lepidoptera the larvæ ("caterpillars") are worm-like, but with well-developed jaws, three pairs of jointed thoracic legs, and a number of unjointed stumpy abdominal legs (*pro-legs*). Lepidopterous larvæ are often brilliantly coloured, are very active, and feed with voracity, chiefly on leaves and other succulent parts of plants. Eventually they spin a cocoon of a silky substance, enclosed within which, and covered with a tough skin, they pass through a quiescent or pupa condition—the condition of the *chrysalis* (Fig. 523). From the interior of this the imago subse-

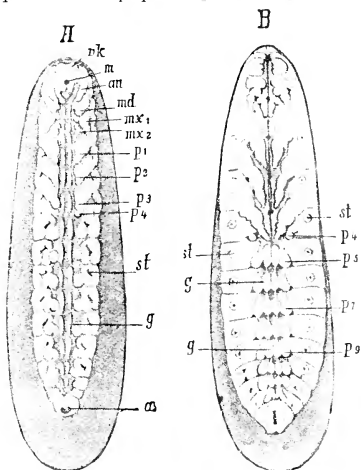

FIG. 540.—A and B, later stages of the embryo of *Hydyophilus* with the rudiments of the extremities; in B the abdominal appendages are visible. *a*, anus; *an*, antenna; *g*, rudiment of the ventral nerve-chain; *m*, mouth; *md*, mandible; *mx*₁, first maxilla; *mx*₂, second maxilla; *p*₁, *p*₂, *p*₃, *p*₄, thoracic legs; *p*₄, *p*₅, *p*₇, *p*₉, rudiments of the appendages of the first, second, fourth, and sixth abdominal appendages; *st*, stigmata; *nk*, prostomium. (From Lang, after Heider.)

quently emerges with all the parts of the adult Insect fully formed.

In **mode of life** there is a very considerable difference between different orders and families of Insects. Some are parasites in the strict sense throughout life. This is the case, for instance, in the Strepsiptera (Bee-parasites), the females of which live permanently lodged between the joints of the abdomen of their hosts. The Lice and Bird-lice are external parasites throughout life; Bugs and Fleas, though not adhering to their hosts, are parasites as regards their diet. Many Insects are parasites in the larval condition,



FIG. 541.—Honey-Bee (*Apis mellifica*). *a*, queen (perfect female); *b*, worker (imperfect female), and *c*, drone (male). (After Brehm.)

though free in the adult state. This holds good, for example, of the larvæ of the Ichneumons, which develop in the interior of the bodies of other insect-larvæ; also of the larvæ of the Bot-flies (Fig. 522), which inhabit the alimentary canal of mammalian hosts (Horses, Oxen, Sheep, Rhinoceroses, Tapirs). The blood-sucking Insects act in certain cases as the carriers or intermediate hosts of the protozoan or bacterial parasites that are the causes of various diseases in man. Thus, as was stated in the account of the malaria-



FIG. 542.—Red Ant (*Formica rufa*); male, worker, and female. (After Brehm.)

parasite (Section II, p. 89), mosquitoes are the means of conveying that disease from one person to another.

In accordance with the high grade of the structure of their various systems of organs, Insects exhibit a correspondingly high degree of functional activity. The quantity of food consumed and assimilated is great in comparison with the bulk of the body, and the energy expended in muscular contractions is of very considerable amount. It is estimated that while the muscular force exerted by a Horse bears a ratio of about 0.7 to its own weight (reckoned as 1) the muscular force of an Insect bears a ratio to its weight of from about 14 to about 23. Insects are also distinguished among the Invertebrata by the keenness of their senses. The sense of sight is, as we should expect from the

elaborate character of the optic organs, the most highly developed, many Insects having been shown by experiment to have a keen sense of colour ; but a sense of smell, the seat of which is in the antennæ and palpi, can be shown to exist in a high degree, and the parts about the mouth bear nerve-endings concerned in a well-developed sense of taste. A sense of hearing does not appear to be universally present, but is well marked in such forms as produce sounds. At the same time Insects are remarkable for the instincts, often leading to results of an elaborate character, which guide them in the pursuit of food and the protection and rearing of their young. Among the insects which are the most highly endowed in this respect are some—the Ants, Bees, Wasps, and Termites—which live together in organised associations or communities, the various individuals composing which are distinguishable into *sexual individuals*, *neuter workers*, and *soldiers* (Figs. 541 and 542), each specially organised for the part which it has to play in the economy of the community.

Distribution in time.—The earliest known fossil remains of Insects have been found in rocks of Silurian age. A good many fossil Insects have been found in the Devonian ; but they only become abundant in the Carboniferous. All the Palæozoic Insects belong to a group which has been regarded as a distinct order, and has been named the *Palæodictyoptera*. The members of this group are characterised rather by the absence of the special characteristics of any of the existing orders than by any positive features of their own ; but different families of the order approximate to a certain extent towards the groups of living Insects. Amongst them, for example, are forms representing the Cockroaches and the Phasmidæ among the Orthoptera ; others representing the modern Day-flies among the Neuroptera ; others the Coleoptera.

Of the existing orders, the Neuroptera, Orthoptera, and Coleoptera are first found in the Trias ; the Hemiptera, Diptera, Hymenoptera, and Lepidoptera in the Jurassic.

CLASS V.—ARACHNIDA.

The class *Arachnida*, comprising the Scorpions and Spiders, the Mites and Ticks, the King-crabs, and a number of other families, is a much less homogeneous group than the Insecta, approaching the Crustacea in the variety which it presents in the arrangement of the segments and their appendages. In most members of the class, however, there is an anterior region of the body—the *cephalothorax*—representing both head and thorax, and a posterior part, or *abdomen*, which is typically composed of a number of distinct segments ; in some cases cephalothorax and abdomen are amalgamated. There are no antennæ in the adult Arachnid, though

rudiments of them have been found in the larvæ of some species. The first pair of appendages of the cephalothorax (probably representing the antennæ of the Crayfish) are the *cheliceræ*; the second are the *pedipalpi*, the representatives of the Crayfish's and Cockroach's mandibles. Behind these are four pairs of legs. The organs of respiration are sometimes tracheæ, similar to those of the Insects, sometimes book-lungs—sacs containing numerous book-leaf-like plates: sometimes leaf-like external appendages or gills.

1. EXAMPLE OF THE CLASS.—THE SCORPION (*Euscorpio* or *Buthus*).

Scorpions are inhabitants of warm countries—the largest kinds being found in tropical Africa and America. They are nocturnal animals, remaining in holes and crevices during the day, and issuing forth at night to hunt for their prey, which consists of Spiders and Insects. These they seize with their pincer-claws and sting to death with their caudal spine, afterwards sucking their juices.

There are a number of different species of Scorpions, divided into several genera, which differ from one another in comparatively unimportant points, so that the following general description will apply almost equally well to any of them.

External features.—A Scorpion (Fig. 543) has a long narrow body, in superficial appearance not unlike that of a Crayfish. There is a small cephalothoracic shield or *carapace*, covering over dorsally a short anterior region—*cephalothorax* or *prosoma*. This is followed by a long posterior region or *abdomen*, the terminal part of which in the living animal is habitually carried over the back (Fig. 546), constituting the “tail,” at the end of which the sting is placed. The carapace bears a pair of large eyes about its middle, and several pairs of smaller eyes on the antero-lateral margin. The anterior, broader part of the abdomen, which is termed the *pre-abdomen* or *mesosoma*, consists of seven segments,¹ each of which is enclosed in firm, chitinous, dorsal and ventral plates, or *terga* and *sterna*. The tergum and sternum of each segment are separated from one another laterally by intervals of soft skin, except in the seventh, where they are united laterally for a longer or shorter distance. The posterior, narrower part of the abdomen, known as the *post-abdomen* or *metasoma*, consists of five segments, each enclosed in a complete investing ring of hard chitinous matter. Articulating with the last segment of the post-abdomen is a terminal appendage, the caudal spine or *sting*, swollen at the base and acutely pointed at the apex, where open

¹ Originally there are eight, but the original first loses its distinctness in embryonic life.

the ducts of two *poison-glands*. The *anal opening* is situated on the ventral surface of the last segment of the post-abdomen, immediately in front of the sting.

The aperture of the *mouth*, which is very small, is at the anterior end of the cephalothorax on its ventral aspect; a lobe which overhangs it in front is the *labrum*. On each side of the mouth is a three-jointed appendage—the *chelicera* (Fig. 544, *chel.*)—which is terminated by a chela. Behind these are the very large *pincers* or *pedipalpi* (*ped.*), each composed of six podomeres and terminating in a powerful chela. The basal joint of each pedipalp

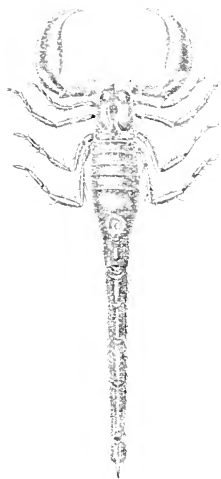

FIG. 543.—**Euscorpio.** (From Cuvier's *Animal Kingdom*.)

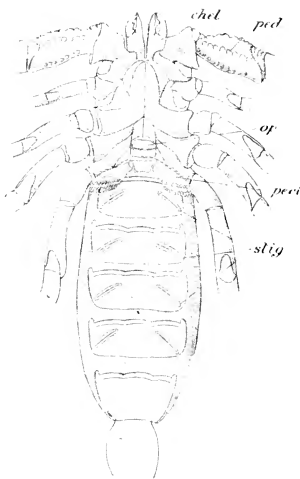

FIG. 544.—**Scorpion.** Ventral surface of the cephalothorax and pre-abdomen. *chel.*, chelicerae; *op.*, operculum; *pect.*, pectines; *ped.*, pedipalpi; *stig.*, stigmata. (From Leuckart and Nitsche's Diagrams.)

has a process which bites against the corresponding process of the other pedipalp, these processes thus performing the function of jaws. Following upon the pedipalpi are four pairs of walking legs, each composed of seven podomeres, the last of which is provided with curved and pointed horny claws. The basal segments of the first two pairs of walking legs are modified so as to perform to some extent the function of jaws.

All the six pairs of appendages hitherto described—the chelicerae, the pedipalpi, and the four pairs of walking legs—belong to the cephalothorax. The first segment of the pre-abdomen (Fig. 544) has a narrow sternum, on which there is a soft rounded

median lobe divided by a cleft; this is termed the *genital operculum* (*op.*); at its base is the opening of the genital duct. To the sternum of the second segment of the pre-abdomen are attached a pair of remarkable appendages of a comb-like shape—the *pectines* (*pect.*)—each consisting of a stem, along the posterior margin of which is a row of narrow processes, somewhat like the teeth of a comb; the function of these appendages is doubtful, but is probably sensory. The remainder of the segments of the pre-abdomen, and all those of the post-abdomen, are devoid of appendages. The



FIG. 545.—Endosternite of **Scorpion**. (After Lankester.)

sterna of the third, fourth, fifth, and sixth segments of the pre-abdomen, which are very broad, bear each a pair of oblique slits—the *stigmata* (*stig.*)—leading into the pulmonary sacs.

In the interior of the cephalothorax, over the nervous system, is a cartilaginous plate—the *endosternite* (Fig. 545)—which serves to give attachment to muscles, and is comparable to the cephalic apodeme of *Apus* (p. 520).

All the appendages of the Scorpion are post-oral in position, and the most anterior—the chelicerae—are probably best regarded as corresponding to the antennae of the Crayfish, the equivalent of the Crayfish's antennules and of the antennae of the Cockroach not being present. The pedipalpi would then be the homologues of the mandibles of the Insect and the Crustacean.

CRAYFISH.	COCKROACH.	SCORPION.
Antennules.	Antennae.	Absent.
Antennae.	Absent.	Chelicerae.
Mandibles.	Mandibles.	Pedipalpi.
First maxillae.	First maxillae.	First legs.
Second maxillae.	Second maxillae.	Second legs.
First maxillipedes.	First legs.	Third legs.
Second maxillipedes.	Second legs.	Fourth legs.
Third maxillipedes.	Third legs.	

Digestive system.—The narrow mouth leads into a large chamber with elastic walls, the *pharynx*; this is capable of being greatly dilated by the action of a number of radiating bundles of muscular fibres which run outwards from it to the walls of the cephalothorax, the result of this being to cause suction through the mouth, by which means the juices of the Scorpion's prey are drawn in. A second dilatation, to which a narrow oesophagus leads, receives the ducts of a pair of *salivary glands* (Fig. 547, *sal. gland.*). Upon this follows the *mesenteron* (*mesent.*), which is an elongated, wide, straight tube, with glandular walls, corresponding to the stomach of the Insect. Opening into the

mesenteron are five pairs of narrow tubes (Figs. 546 and 547, *hep. du.*) leading into the substance of a large glandular body, usually termed the *liver (hep.)*, though its hepatic functions are doubtful. Into the long narrow intestine, in the last segment of

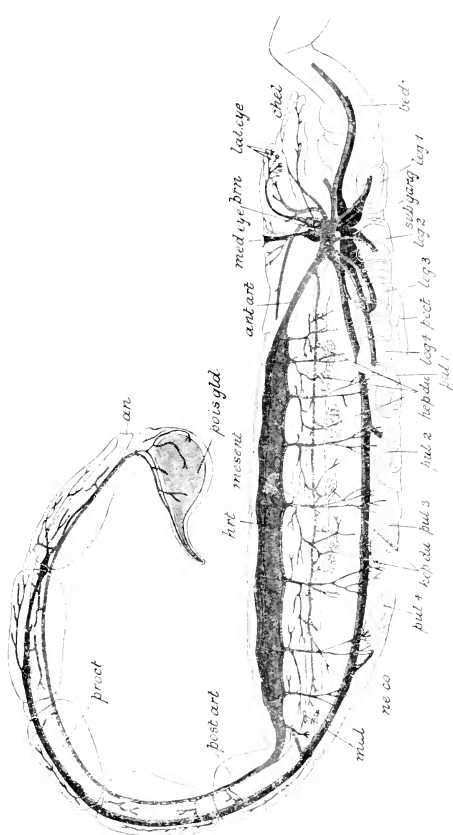

FIG. 546.—Diagrammatic side view of the internal organs of **Scorpion**. *an.*, anus; *ant. art.*, anterior aorta; *brain*, brain; *chel.*, chelicere; *hep. du.*, hepatic duct; *lat. eye*, lateral eye; *leg 1-4*, legs; *mal.*, Malpighian tubes; *med. eye*, median eye; *mesent.*, mesenteron; *nr. co.*, nerve cord; *post. art.*, posterior aorta; *proct.*, proctodaeum; *sub. gang.*, sub-oesophageal ganglion. (From Leuckart, after Newport and Blanchard.)

the pre-abdomen, open one or two pairs of delicate tubes—the *Malpighian tubes (mal.)*—which act as the organs of renal excretion.

Circulatory organs.—An elongated tubular *heart (hrt.)* lies in the pre-abdomen enclosed in a pericardial sinus; it is

divided internally by folds into a series of eight chambers; into each of these chambers the blood passes by a pair of valvular apertures or *ostia*. The heart ends both in front and behind in main arteries, the *anterior* and *posterior aortæ* (*ant. art.*, *post. art.*); and a series of pairs of lateral arteries are given off from the various chambers. The anterior aorta soon bifurcates to form a pair of vessels which embrace between them the œsophagus, and meet below in a median ventral trunk which runs backwards above the nerve-cord. The blood carried to the various parts of the body by the arteries is gathered up into a large ventral sinus from which it passes to the book-lungs. From these it is carried by a series of veins to the pericardial sinus to enter the heart through the ostia.

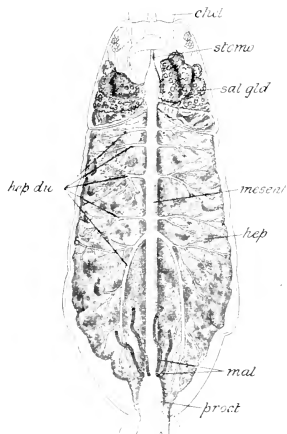

FIG. 547.—Dorsal view of the internal organs of **Scorpion**. *chol*, chelicere; *hep*, liver; *hep. du.*, hepatic ducts; *mal*, Malpighian tubes; *mesent*, mesenteron; *proct*, intestine; *sal. gland*, salivary glands; *stomo*, stomodæum. (From Leuckart, after Blanchard.)

The **organs of respiration** in the Scorpions are in the form of *pulmonary sacs* or *book-lungs* (*pul.*), the *stigmata* or external openings of which have already been referred to. Each pulmonary sac is a compressed chamber lined with a thin cuticle. The lining membrane is raised up into numerous delicate laminae lying parallel with one another like the leaves of a book. Into the numerous narrow spaces between the laminae the air penetrates, and oxygenates the blood which enters the interior of the laminae from the ventral sinus.

A pair of *coxal glands*, situated near the base of the fifth pair of appendages, are, in the embryo Scorpion, represented

in the second to the sixth segments by tubes which grow out from the cœlomic sacs; in the adult Scorpion only the one pair persists, in the form of a closed gland, and its function is quite uncertain.

The **nervous system** is constructed on a plan which bears a considerable resemblance to that of the Crayfish and that of the Cockroach. There is a bilobed cerebral ganglion or *brain* (*Fig. 516. bru.*) from which nerves are given off to the eyes; a nerve-collar formed of a pair of *œsophageal connectives* unites ventrally in a *sub-œsophageal ganglion*, forming the anterior part of a *ventral nerve-cord* (*nc. co.*). The connectives and sub-œsophageal ganglion give rise to the nerves of the first six pairs of appendages and of the

operculum, the pectines, and the two following segments. The first ganglion behind the subœsophageal ganglion appears in the eleventh segment (reckoning the cephalothorax as made up of six); behind which a ganglion occurs regularly in each segment as far back as the fourth of the post-abdomen.

The **organs of special sense** are the *eyes* and *pectines*. The lateral eyes (Fig. 566) are similar in character to the simple eyes or ocelli of Insects. The two larger central eyes (Fig. 567) differ from them in having the retinal cells arranged in groups as in the compound eye, but resemble them in the presence of a single cuticular lens.

Reproductive organs.—In the male the *testes* consist of two pairs of longitudinal tubules united by cross branches. These are connected with a median *vas deferens*, the terminal portion of which, provided with *accessory glands*, is modified to form a double penis; its external opening is just behind the operculum, as already noticed. There is an unpaired *ovary*, which is made up of three longitudinal tubules with transverse connecting branches; the oviducts open on the operculum.

Scorpions are viviparous. The *eggs*, which are spherical or oval, and in most species contain a large amount of food-yolk, lie in a follicle formed of a diverticulum of the oviduct. Fertilisation either occurs in the follicle or after the egg has escaped into the oviduct. The further development takes place in the oviducts; and, when born, the young Scorpion differs from the parent very little save in size.

Development.—The segmentation is of the type to which the term *discoidal* is applied. On one pole are formed a number of cells in the form of a one-layered *disc* or cap, which gradually spreads over the yolk. On this appears a thickening—the *ventral plate* (Fig. 548) corresponding to that of the Insect. A longitudinal groove which appears on the surface of this may be regarded as representing an elongated blastopore (Fig. 548, A). The cells of the

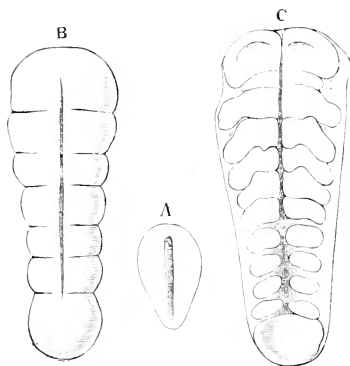

FIG. 548.—Three surface views of the ventral plate of a developing **Scorpion**. A, before the appearance of segments; B, after five segments have become formed; C, after the appendages have begun to be formed. (From Balfour, after Metschnikoff.)

blastoderm of the ventral plate become divisible into three layers—*ectoderm*, *endoderm*, and *mesoderm*. The mesoderm undergoes division into a series of masses which are hollowed out to form the primitive segments (*B*) and their cavities. Embryonic membranes—*serosa* and *amnion*—are formed as in the Insects. When about ten segments have become distinguishable, the rudiments of appendages (Fig. 548, *C*, and Fig. 549) appear in the form of hollow processes of the segments on either side of the middle line. Behind the rudiments of the thoracic limbs appear a series of seven pairs of abdominal appendages (ab^1-7); the first early disappear; the place of the second is afterwards taken by the operculum; the third develops into the pectines. The four posterior pairs become aborted; the book-lungs appear as pits at their bases.

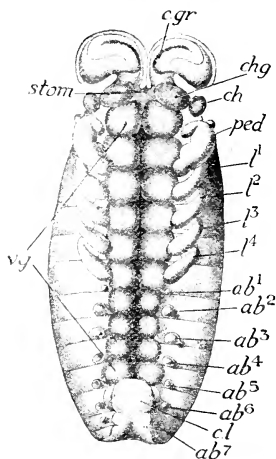

FIG. 549.—Embryo of Scorpion (*Euscorpio carpathicus*), with rudimentary appendages. ab^1-7 , abdominal appendages; *ch*, chelicera; *ch.g.*, rudiment of cheliceran ganglion; *c.gr.*, cephalic groove; *c.l.*, caudal lobe; l^1-4 , walking legs; *ped.*, pedipalp; *stom.*, opening of stomodæum; *c.g.*, ganglia of ventral nerve cord. (From MacBride, after Brauer.)

The sexes are nearly always separate, and there is usually no metamorphosis.

The class is divided into the following orders:—

ORDER I.—SCORPIONIDA.

Arachnida in which the body consists of a continuous cephalothorax and an abdomen, the latter consisting of an anterior broader pre-abdomen of seven segments, and a posterior, narrower post-abdomen of five segments, with a caudal spine in the form of a sting. There are small chelate chelicerae and large chelate pedipalpi.

2. DISTINCTIVE CHARACTERS AND CLASSIFICATION.

The Arachnida are air-breathing Arthropoda in which the body is usually distinguishable into two regions—cephalothorax and abdomen. The cephalothorax bears sessile, usually simple eyes, two pairs of jointed appendages—the chelicerae and pedipalpi—and four pairs of legs. There are no antennae. The organs of respiration, when present, are usually either tracheae or book-lungs, but in the Xiphosura take the form of book-gills. Heart and vascular system are usually present; the heart is tubular, like that of the Insects.

A pair of comb-like pectines occur on the second segment of the pre-abdomen. The organs of respiration are four pairs of book-lungs in the third, fourth, fifth and sixth segments of the pre-abdomen.

This order includes the Scorpions.

ORDER 2.—PSEUDOSCORPIONIDA.

Arachnida in which there is a continuous cephalothorax, sometimes marked dorsally with two transverse grooves, and a broad abdomen, not divided into pre- and post-abdomen, and not provided with a sting. The chelicerae are very small, the pedipalpi similar to those of the Scorpions. The organs of respiration are a system of tracheae. A pair of spinning glands are present.

This order includes the Book-scorpions (Fig. 550).

ORDER 3.—PEDIPALPIDA.

Arachnida in which the body consists of unsegmented cephalothorax and flattened abdomen of eleven to twelve segments. The chelicerae are simple, the pedipalpi simple or chelate, and the first pair of legs terminate in a many-jointed flagellum. The organs of respiration are two pairs of book-lungs on the second and third segments of the abdomen.

This order includes the Scorpion-spiders (Fig. 551).

ORDER 4.—SOLPUGIDA.

Arachnida with three regions—head, thorax (of three segments), and abdomen (of ten segments). The chelicerae are chelate; the pedipalpi elongated and leg-like. The organs of respiration are tracheae.

This order includes *Galeodes* (Fig. 552).

ORDER 5.—PHALANGIDA.

Arachnida with an unsegmented cephalothorax, and an abdomen of six segments. The chelicerae are chelate, the pedipalpi leg-like. The organs of respiration are tracheae. No spinning glands are developed.

This order includes the Harvestmen.

ORDER 6.—ARANEIDA.

Arachnida in which the body is composed of an undivided cephalothorax and an unsegmented abdomen, which is usually soft and rounded, and attached to the cephalothorax by a narrow neck. The chelicerae are sub-chelate, with poison-glands; the pedipalpi simple. The organs of respiration are book-lungs alone, or book-lungs combined with tracheae.

This order comprises all the true Spiders (Fig. 553).

ORDER 7.—ACARIDA.

Arachnida in which the body exhibits no division into regions. The mouth-parts are adapted either for biting or piercing and sucking. The organs of respiration, when present, are in the form of tracheæ.

This order includes the Mites and Ticks (Figs. 556 and 557).

ORDER 8.—XIPHOSURA.

Arachnida in which the body consists of a cephalothorax covered over by a broad carapace, and an abdomen of seven firmly united segments, with a long narrow tail-piece or telson. The cephalothorax bears a pair of short chelate appendages and five pairs of legs. The abdomen bears in front a pair of united plate-like appendages, forming the *operculum*, followed by five pairs of flat appendages overlapped by the operculum. The organs of respiration are lamelliform gills attached to the abdominal appendages.

This order includes the King-crabs (*Limulus*, Figs. 558 and 559).

ORDER 9.—EURYPTERIDA.

Arachnida with a relatively small cephalothorax, followed by twelve free segments and a terminal, elongated, narrow telson. There are a pair of pre-oral leg-like or chelate appendages and four more leg-like appendages on the cephalothorax, the last expanded to form swimming paddles. A broad operculum is situated immediately behind the cephalothorax. There are pairs of lamellate appendages on certain of the anterior free segments. The exoskeleton is characteristically sculptured.

This order includes only a number of extinct (Palæozoic) forms of large size (Fig. 560).

3. GENERAL ORGANISATION.

The **external form** in the *Scorpionida* has already been sufficiently described. Most nearly related to that order in this respect are the *Pseudoscorpionida* or Book-scorpions and their allies. In these (Fig. 550) there is an unsegmented cephalothorax, or the carapace is crossed by two transverse grooves which may indicate segmental divisions. There is a broad abdomen consisting of eleven or

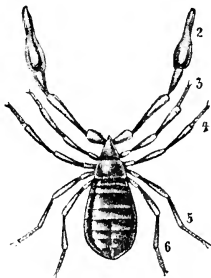

FIG. 550.—*Chelifer bravaissii*.
2—6, second to sixth pairs of
appendages. (From Lang's
Comparative Anatomy.)

twelve segments; the post-abdomen is not represented, nor the caudal sting. The chelicerae are small; the pedipalpi are large, and resemble those of the Scorpions in their chelate form. Spinning glands are present.

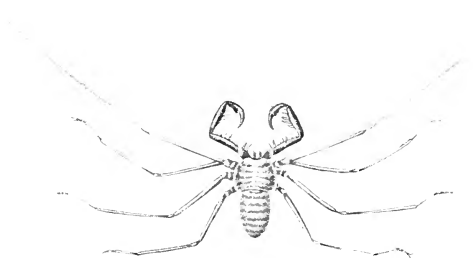

FIG. 551.—**Phrynus.** (From Cuvier's *Animal Kingdom.*)

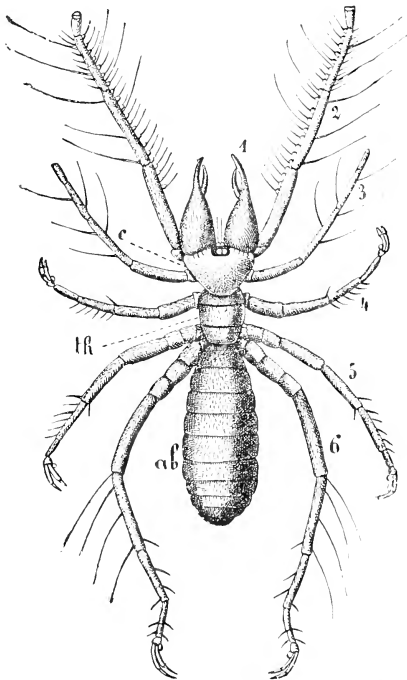

FIG. 552.—**Galeodes dastuguei** ♀, natural size. 1—6, the six pairs of appendages; 1, chelicerae; 2, pedipalpi; c, head; th, thorax; ab, abdomen. (From Lang, after Dufour.)

The *Pedipalpi*, or Scorpion-spiders (Fig. 551), are intermediate in some of their external features between the Scorpions and the Spiders. The abdomen is broad and marked out into a series

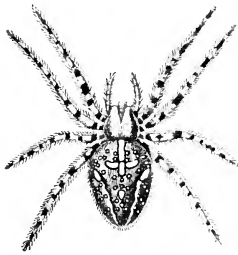

FIG. 553.—Spider (*Epeira diadema*).

of eleven or twelve distinct segments; in one of the genera of the order there is a short post-abdomen formed of the last three segments, with an elongated, many-jointed *anal filament*. The chelicerae end in simple claws; they are probably provided with poison-glands; the pedipalps are very long, either claw-like or chelate; the first pair of legs are very long and slender, their terminal part made up like antennae of numerous short joints. There are eight eyes on the carapace, two larger central, and six smaller marginal.

The *Solpugida* (Fig. 552) have, at least superficially, the appearance of being intermediate between the Insecta and the other groups of Arachnida. The cephalothoracic region is divided by a constriction into two parts, *head* and *thorax*, the latter made up of three segments. The

chelicerae are chelate; the pedipalpi resemble the legs, and are used in locomotion. The first pair of legs are attached to the head. The abdomen is distinctly segmented, and there is no caudal appendage. A pair of poison-glands open at the bases of the chelicerae. There are two simple eyes on the head.

In the *true Spiders* (Fig. 553) the abdomen is rounded, unsegmented, and separated off from the cephalothorax by a constriction. The chelicerae (Fig. 554, *A*) are sub-chelate, and the duct of a large poison-gland opens at the extremity. The pedipalpi (Fig. 554, *B*) are elongated, six-jointed, and end in simple extremities; in the male (Fig. 555) the terminal joint is modified to serve for the reception and transference of the sperms.

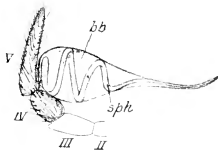

FIG. 555.—Pedipalp of male of *Epeira diadema*. II, III, IV, V, podomeres; bb, sac; sph, spiral tube. (After Leuckart.)

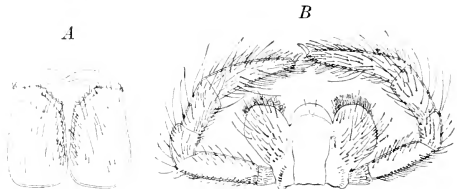

FIG. 554.—*A*, Chelicerae, and *B*, pedipalpi of female of *Epeira diadema*. (After Leuckart.)

At the extremity of the abdomen is the spinning apparatus or *arachnidium* (Fig. 561, *arach.*). This consists of four or six elevations, the *spinnerets*, usually jointed, probably derived from embryonic rudiments of abdominal appendages. On the surfaces of these open the numerous fine ducts of the spinning glands (*sp. glds.*), secreting the material of which the spider's web is composed. The fine threads of viscid secretion issuing from the ducts harden on exposure to the air, and are worked up into the web by means of the posterior legs. There are six or eight eyes on the carapace.

In the spider-like *Phalangida*, or "Harvestmen," the cephalothorax is not constricted off from the abdomen. The chelicerae are chelate, the pedipalpi short and leg-like, the legs long and slender.

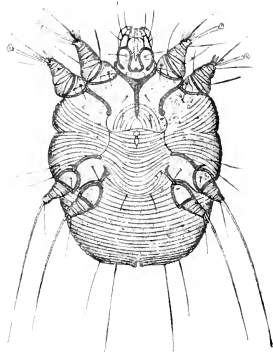

FIG. 556.—Itch mite (*Sarcoptes scabiei*). (After Leuckart.)

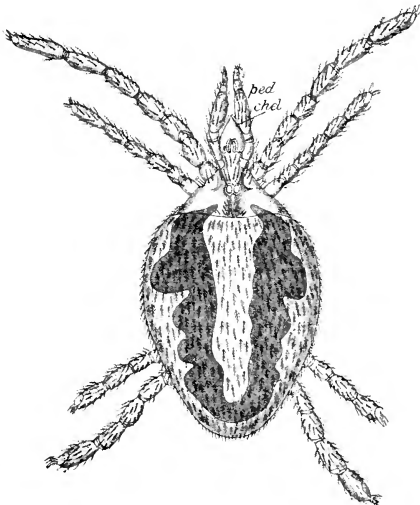

FIG. 557.—Water mite (*Trombidium fuliginosum*), female. *chel.* chelicerae; *ped.* pedipalpi. (After Leuckart.)

In the *Acarida*, or Mites and Ticks (Figs. 556 and 557), the distinction into regions is no longer recognisable. The form of the mouthparts varies somewhat in the different families. Sometimes the basal portions of the pedipalpi form a sucking proboscis enclosing the stylet-like chelicerae, modified to form piercing organs; sometimes these appendages are claw-like or chelate. The legs vary somewhat in shape in the different

groups, according as they are used for prehension, for creeping, for running, or for swimming; they end usually in two claws, between which there may be discs or stalked suckers.

In the *Xiphosura* or King-crabs (Fig. 558), the body consists of two well-marked regions—*cephalothorax* and *abdomen*. The former is covered over by a wide, dorsally convex, sub-crescentic shield or carapace, bearing two large compound eyes, and two smaller simple eyes. The segments of the abdomen (seven in number) are united

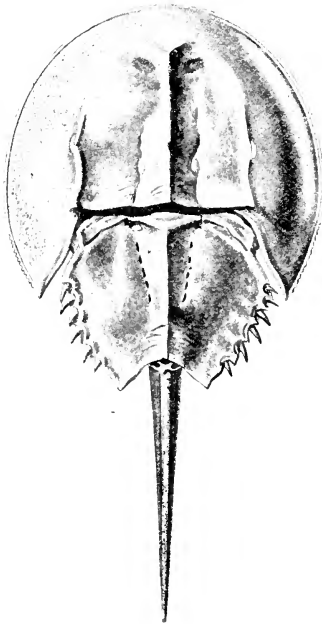

FIG. 558.—*Limulus*. Dorsal aspect.
(After Leuckart.)

together, being covered dorsally by a continuous abdominal carapace. At the posterior end is attached a very long, narrow, *caudal spine* or *telson*. The anterior appendages (Fig. 559) resemble those of the Scorpion. In front of the mouth is a pair of short, three-jointed, chelate appendages, the *chelicerae* (*I*), at the sides of a labrum (*rostrum*) or upper lip. Behind these follow a series of five pairs of legs, the bases of all of which, with the exception of the last, are covered with spines, and have the action of jaws, while the extremities are for the most part chelate. The first pair of appendages of the abdomen are flat plates, which are united together in the middle line and together form the broad *operculum* (*operc.*) overlapping all the posterior appendages; on its posterior face are the two genital apertures. The posterior appendages, of which there

are five pairs, are thin flat plates to which the gills are attached; each of them is divided by a suture into a small inner ramus or endopodite, and a larger external ramus or exopodite. Between the sixth pair of appendages is a pair of processes, the *chilaria*.

In the *Eurypterida* (Fig. 560) there is a small cephalothorax bearing a pair of large eyes and a pair of ocelli, and an elongated segmented region containing twelve segments, followed by a narrow pointed telson. There are usually five pairs of limbs

surrounding the mouth and, with the exception of the first, toothed at the bases in order to perform the functions of jaws; the last pair are stouter than the others and are expanded so as, apparently, to assume the character of swimming paddles. Certain of the more anterior of the free segments bear paired lamelliform appendages which probably carried the branchiæ, as in the Xiphosura. The exoskeleton is in many cases elaborately sculptured.

A cartilaginous internal **endosternite** of the same nature as that which has been described as occurring in the Scorpions is found in *Limulus* and in certain Spiders, but not in the other groups.

Coxal glands, similar to those that have been described in the Scorpion, occur also in most Spiders, in the Solpugida and Phalangida, in some Acarida, and in the Xiphosura. In the Solpugida and Phalangida they occur in the bases of the last pair of legs; in the Araneida and Xiphosura, they are found on the bases of the fifth pair of appendages.

Alimentary system.—The mouth of the Spiders leads into a pharynx (Fig. 561, *ph*) followed by a narrow œsophagus

(*œs.*) expanded behind into a special *sucking stomach* (*suck. st.*). The *mesenteron* (*mesent.*) gives off in the cephalothorax a pair of large diverticula from each of which arise five narrow branches (*cœ.*), the last four of which enter the bases of the legs; in the abdomen it is surrounded by a mass of cells commonly termed "liver" (*hep.*), the ducts of which open into it. The *rectum* or *proctodæum* gives off dorsally a large *cloacal sac* (*rect. cœ.*) into which open a pair of

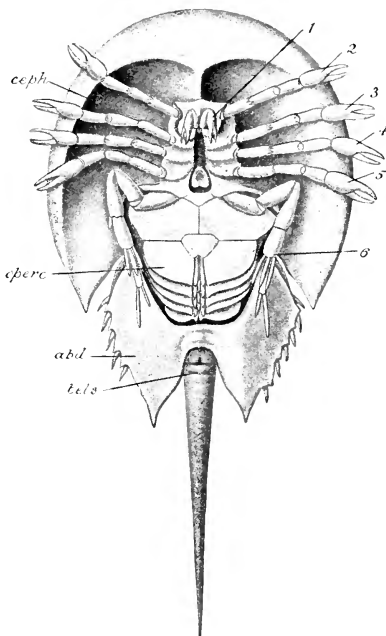

FIG. 559.—Ventral view of *Limulus*. 1-6, appendages of cephalothorax; *abd.* abdomen; *ceph.* cephalothorax; *operc.* operculum, behind which are seen the series of abdominal appendages; *tels.* caudal spine or telson. (After Leuckart.)

narrow tubes, the so-called "Malpighian tubes," which are not the homologues of the tubes so named in the Insects, being, with the cloacal sac, of endodermal and not ectodermal derivation.

In the Pseudoscorpionida the mesenteron, which is bent into a loop, gives off three diverticula; the proctodæum has also a diverticulum. In the Solpugida the mesenteron also gives off diverticula; the occurrence of Malpighian tubes is doubtful. In the Acarida there are always diverticula, the number and arrange-

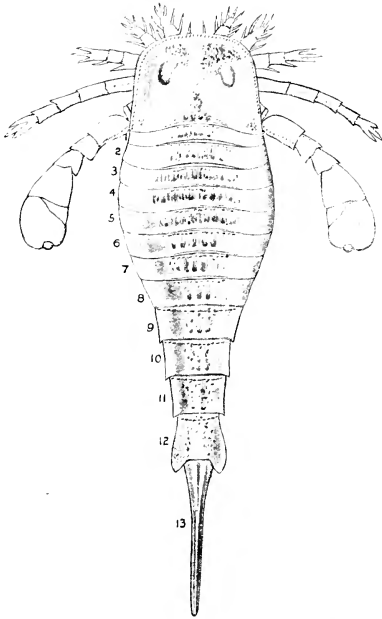

FIG. 560.—*Eurypterus fischeri* (Silurian).
(From Nicholson and Lydekker.)

ment of which vary, connected with the mesenteron. There are usually two long Malpighian tubes which may be fused mesially.

In the Xiphosura, the mouth (Fig. 562, *mo.*), which is situated some distance behind the anterior extremity of the body, leads into a suctorial pharynx, followed by a stomach, which opens into the elongated mesenteron; the proctodæum, a short tube with folded walls, opens on the exterior at the posterior extremity of the abdomen. Into the mesenteron, as in the Scorpion, open the ducts of a large gland, usually termed the "liver" (*l. liv.*).

A heart is absent in many of the Mites.

In the other Arach-

nida a heart is present and has the same general form as in the Scorpions, though always more concentrated.

In the various orders the organs of respiration differ a good deal in their character. In the Pseudoscorpionida they take the form of branching *tracheæ* similar to those of Insects. In the Pedipalpi there are two *pulmonary sacs* or *book-lungs* similar to those of the Scorpions. In the Solpugida there is a system of *tracheæ*. In the Spiders there are either four pulmonary sacs

(Fig. 563). or two pulmonary sacs and a system of tracheæ (Fig. 564). Tracheæ are present in the Phalangida and also in the majority of the Acarida.

In the Niphosura the organs of respiration are external appendages or gills (book-gills), in the shape of delicate laminae attached to the abdominal appendages (Fig. 565).

The nervous system is, in most instances, more concentrated than in the Scorpions. There may be one or two separate abdominal ganglia behind the mass formed by the united cephalothoracic and anterior abdominal (Pseudoscorpionida, Pedipalpida, some Araneida, Solpugida, Phalangida). In most of the Araneida and in the Acarida all the abdominal are united with all the cephalothoracic ganglia to form

a single mass perforated by the œsophagus, the part lying behind, which is much the larger, representing the ventral nerve-cord.

Sense-organs.—Eyes are present in all except in some of the

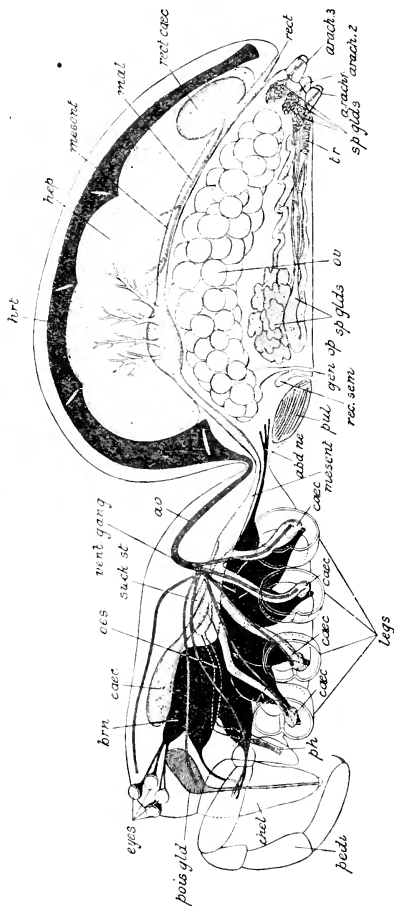

FIG. 561.—Diagrammatic lateral view of the internal organs of a diploemmonous Spider. *abd.*, *ab.*, abdominal nerves; *ao*, aorta; *arachn.* 1, 2, 3, archæidium; *brn*, brain; *chel*, chelicere; *caec*, mesenteric diverticula and their branches; *gen. op*, genital opening; *hrt*, "liver"; *hrt*, heart; *legs*, legs; *mal*, Malpighian tubules; *mesent*, mesenteron; *oes*, œsophagus; *ov*, ovary; *pedi*, pedipalpi; *ph*, pharynx; *pois. gland*, poison gland; *pul*, lung; *rec. sem*, receptaculum seminis; *rect. caec*, dilatation of the rectum; *rect*, rectum; *sp. glands*, spinning glands; *suck. st*, sucking stomach; *tr*, trachea; *vent. gang*, ventral ganglion of cephalothorax. (After Leuckart.)

Acarida. Their number and arrangement have been given with the external characters of the groups. They are all (Fig. 566) of the type of the *ocelli* or simple eyes of Insects, except the central eyes of the Scorpions (Fig. 567) and the compound eyes of *Limulus*. The former are intermediate in character between ocelli and faceted

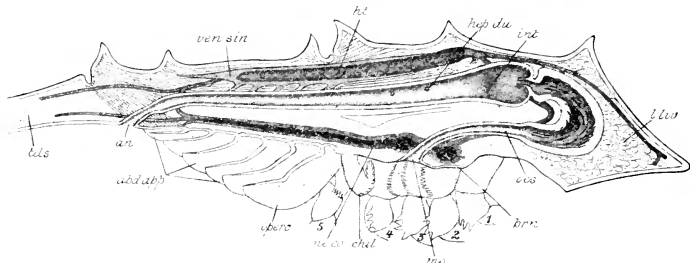

FIG. 562.—Diagrammatic view of a median longitudinal section of *Limulus*. *abd. app.* abdominal appendages; *an.* anus; *brn.* brain; *chil.* chilaria; *hep. du.* opening of one of the hepatic ducts; *ht.* heart; *int.* intestine; *l. liv.* "liver"; *mo.* mouth; *ne. co.* nerve-cord; *oes.* oesophagus; *operc.* operculum; *tels.* telson; *ven. sinus*, venous sinus; 1—5, legs. (From Leuckart, partly after Packard.)

eyes, possessing the single cuticular lens (*lens*) of the ocellus, and resembling the faceted eye in having the retinal cells arranged in groups corresponding to ommatidia. Each retinula, composed of five cells, contains a thick axial rod or rhabdome (*rhabd.*).

In *Limulus* the compound eye has a continuous chitinous cornea of the nature of a thickening of the cuticle. This, though non-faceted, differs from the corresponding part in the compound eye of the Scorpion in being produced internally into a number of conical papillæ, each of which lies over one of the ommatidia and may be looked upon as its lens.

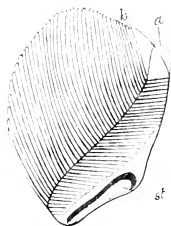

FIG. 563.—Book-lung of a Spider (*Zilla callophylla*). *a.* axis; *b.* lamina; *st.* stigma. (From Hertwig.)

A considerable variety is observable in the exact arrangement of the parts of the **reproductive apparatus** in different groups of the Arachnida. In general, *testes* or *ovaries* are either paired or (more rarely) unpaired tubes, with paired *vasa deferentia* or *oviducts*, which unite in a median duct opening on the exterior by an unpaired genital opening. Viviparity is exceptional. In the Spiders the ovaries (Fig. 561, *ov.*) are two wide tubes, on the surface of which follicles project prominently; sometimes they unite into a single circular ovary. There are two short oviducts even when the ovary is single; these unite in a median *vagina*, which opens on the exterior by a median genital aperture at the base of the abdomen.

One, two, or three *receptacula seminis* (*rec. sem.*) are present, and either open into the vagina or independently on the surface. In the male there are two elongated tubular *testes* with two narrow and often greatly coiled *efferent ducts*, which unite in a short

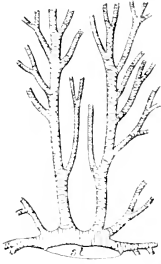

FIG. 564.—Main branches of the tracheal system of a **Spider**. *st.* stigma. (From Hertwig, after Bertkau.)

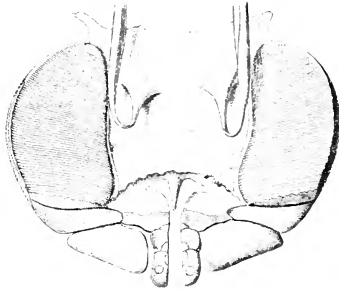

FIG. 565.—One of the book-gills of **Limulus**, with the appendage to which it is attached. (After Lankester.)

median *vas deferens*, the aperture of which is on the base of the abdomen between the stigmata of the first pair. The pedipalpi of the male (Fig. 555) are modified to act as intromittent organs: the terminal segment is swollen, and contains a twisted tube (*sph.*) into which the sperms from the reproductive aperture are received in order to be transferred in the act of copulation to the reproductive aperture of the female. The eggs of spiders are laid in nests or cocoons, and are usually guarded by the mother, sometimes carried about by her.

In their **mode of life** the Arachnida present almost as great a diversity as the Insecta. Some Acarida are parasites throughout life. Most of the other groups of Arachnida are predaceous—preying for the most part on Insects or other Arachnids. To capture the Insects which constitute their food, the majority of Spiders construct a web formed of the threads secreted by the arachnidium. The primary

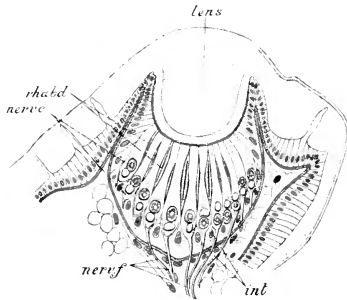

FIG. 566.—Section of the lateral eye of **Euscorpium italicus**. *int.* intermediate cells; *lens*, cuticular lens; *ner. c.* terminal nerve-cells; *ner. f.* nerve-fibres of optic nerve; *rhabd.* rhabdomes. (After Lankester and Bourne.)

function of the threads formed from the secretion of the spinning organ is to constitute the material for the manufacture of a cocoon enclosing the eggs, and in some Araneids this is the sole purpose to which they are devoted. In others there is added a nest for the protection of the eggs and of the parent itself; this in many cases becomes a permanent lurking-place which the Spider inhabits at all seasons, and from which it darts out to capture its prey; in the Trap-door Spider the nest has a closely fitting hinged lid. In very many Spiders the secretion is used mainly to form the web by means of which the prey is snared, and frequently also a nest in which the Spider lies in wait. A subsidiary function of the threads is to aid in locomotion, the Spider being enabled by means of them to let itself down safely from considerable heights, and even to float in the air.

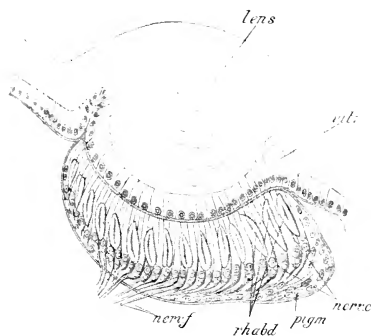

FIG. 567.—Section of the central eye of **Euscorpium**. Letters as in preceding figure. *pigm.*, cells containing pigment; *utr.* vitreous body (a specialised part of the ectoderm). (After Lankester and Bourne.)

Some of the Mites, as already mentioned, are parasitic; others feed on various kinds of fresh or decaying animal or vegetable substances. Most free Acarida are terrestrial; some are aquatic.

The Xiphosura are marine, living at a depth of a few fathoms in warm seas, burrowing in sand; their food consists of various kinds of marine Annelids.

Geological History.—The most ancient of the living groups of the Arachnida are the Scorpions, which are represented in Silurian rocks by various fossil forms not differing very widely from those existing at the present day. The earliest known fossil Spiders have been found in deposits of Carboniferous age; and remains of Pedipalpida occur in the same formation. In Tertiary deposits there have been found representatives of all the principal groups of living Arachnida.

The earliest fossil-remains of Xiphosura that have been found occur in strata of the Triassic period. Other fossil species occur in later formations. These are all nearly related to the living species of *Limulus*. The Eurypterida, as already noted, are entirely Palæozoic, ranging from the Lower Silurian rocks to the Devonian.

APPENDIX TO THE ARACHNIDA.

THE PYCNOGONIDA, LINGUATULIDA, AND TARDIGRADA.

These three groups, though not in any way related to one another, and of doubtful relationships to the Arachnida, are, as a matter of convenience, mentioned together here.

THE PYCNOGONIDA.

These are marine Spider-like Arthropods (Fig. 568) in which the body consists of a cephalothorax composed of an anterior proboscis (*s.*), three head-segments, and one thoracic segment, followed by three free thoracic segments and a rudimentary abdomen (*ab.*). The cephalothorax bears usually four simple eyes and four pairs of appendages, the first of which may be chelate. To these succeed a pair of ovigerous legs (*3*), and the first pair of thoracic legs (*4*). The free thoracic segments bear lateral processes for the articulation

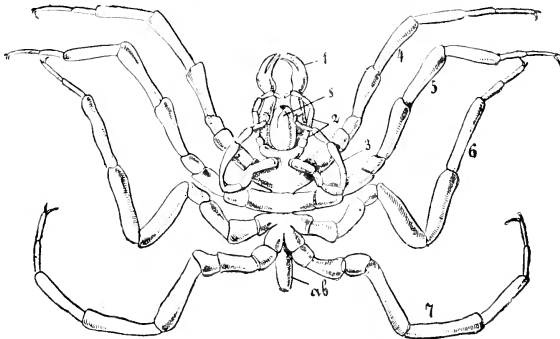

Fig. 568.—**Nymphon hispidum.** 1—7, appendages; *ab.* abdomen; *s.* proboscis.
(From Lang, after Hoek.)

of the remaining three pairs of legs. A number of Antarctic species have five pairs of legs. The rudimentary abdomen (*ab.*) is devoid of appendages.

Diverticula from the mesenteron penetrate for a considerable distance into the limbs. Malpighian vessels are absent. There is a tubular heart with two or three pairs of ostia. Organs of respiration are absent. The nervous system consists of brain, sub-oesophageal ganglia and three other ganglia in the cephalothorax, and one or two small pairs in the abdomen. The testes in the male are partly, and the ovaries in the female either partly or completely, contained in the bases of the thoracic appendages on which they open. In the male 4-7 cement-glands are situated in the fourth joints of certain of the appendages; their secretion cements the eggs together into masses which are carried on the ovigerous legs of the male, and in one species on those of the female also.

A metamorphosis occurs in most cases. The larva usually has three pairs of appendages, so that it bears a superficial resemblance to a nauplius; but the appendages are simple, and in other respects the larva has no essential likeness to the nauplius form. Additional segments with their appendages are formed behind the original three until the form of the adult is completed.

Different kinds of Pycnogonids occur at various depths from between tidal limits to considerable depths in the ocean. The larvæ of the species of one genus are internal parasites in certain hydroid Zoophytes.

THE LINGUATULIDA OR PENTASTOMIDA.

The Linguatulida (Fig. 569) are parasitic animals, which, when superficially examined, present little appearance of affinity with the Arthropoda. The body is completely worm-like, not divided into regions, and presenting only a superficial annulation, which in no way corresponds with division of the body into segments. The sole representatives of limbs are four hooks (*hk.*) at the sides of the mouth. The muscular fibres are striated. The alimentary canal is simple and straight, and Malpighian tubes are absent.

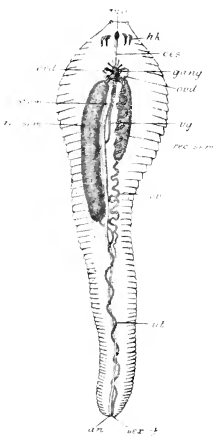

FIG. 569.—*Pentastomum tænioides*, young female. *an.* anus; *gang.* ganglion; *hk.* hooks; *mo.* mouth; *æs.* œsophagus; *ov.* ovary; *ovid.* oviduct; *rec. sem.* receptaculum seminis; *ser. ap.* sexual aperture; *stom.* stomach; *ut.* uterus. (After Leuckart.)

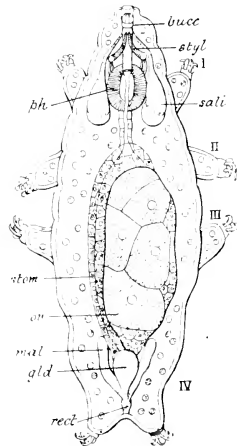

FIG. 570.—*Macrobiotus hufelandi*. I—IV, appendages; *bucc.* buccal cavity; *gld.* accessory gland; *mal.* Malpighian tube; *ov.* ovary; *rect.* rectum; *sali.* salivary glands; *stom.* stomach; *styl.* teeth. (From Hertwig's *Lehrbuch*, after Greef and Plate.)

Heart and organs of respiration are wanting. The nervous system is greatly reduced. A narrow nerve-collar surrounds the œsophagus, presenting no brain-enlargement, and connected behind with a single ventral nerve-mass. Organs of special sense are absent.

Some species of *Pentastomum* are in the adult condition parasites in the lungs of snakes. One species (*Pentastomum tænioides*) inhabits certain cavities—the frontal sinuses and maxillary antra connected with the nasal chambers—in the Dog and Wolf. Its embryos, escaping and falling on grass and other herbage, which form the food of Hares and Rabbits, are taken up by these animals, and perforating the wall of the alimentary canal, by means of a boring apparatus composed of several chitinous pieces, lodge themselves in the liver, where they become encysted and undergo a metamorphosis.

Afterwards they leave the cysts and move about. If the young *Pentastomum* should be received into the mouth of a Dog (still contained probably in most cases in the tissues of the Hare or Rabbit) it may find its way to the frontal sinuses or maxillary antra, there to undergo its final transformation into the adult form. The larva possesses two pairs of short legs.

THE TARDIGRADA.

The Tardigrada ("Bear-animalcules") are soft-skinned animals (Fig. 570) of minute size, not exceeding a millimetre in length. The body is unsegmented and not distinguishable into regions, except that in some a slight constriction separates off an anterior part or head from the rest. The mouth is provided with a sucking proboscis. There are four pairs of short unjointed legs (I.—IV.), the last of which is terminal, and each is provided with two or four claws. The mouth is surrounded by papillæ; the buccal cavity contains a pair of horny, sometimes partly calcified, teeth (*styl.*). The ducts of a pair of salivary (?) glands (*sali*) open into the cavity of the mouth; there is a muscular pharynx (*ph.*), a narrow œsophagus, and a wide mesenteron (*stom.*); the anus is sub-terminal, situated in front of the last pair of limbs. A pair of tubes (*mal.*) which open into the terminal part of the intestine are perhaps representatives of Malpighian tubes. The muscles are all non-striated. There are no organs of respiration, and heart and blood-vessels are likewise absent. There are a brain and a ventral nerve-cord with four ganglia. Two eye-spots situated at the anterior end are the only representatives of organs of special sense. The gonads in both sexes are saccular, and open into the terminal part of the intestine. Segmentation is complete and regular. The young animal at one stage has only two pairs of rudimentary legs, but develops the full number before being hatched. The larva possesses a head and four distinct segments.

Some of the Tardigrada live among damp moss; others in fresh or in salt water.

RELATIONSHIPS OF THE AIR-BREATHING ARTHROPODA.¹

Notwithstanding the existence of some striking superficial resemblances between the Arachnida and the Insecta, the evidence afforded by anatomy and embryology points to the conclusion that there is no direct genetic relationship between the two groups. The occurrence in both of a peculiar form of respiratory organs, the tracheæ, seems at first sight to indicate such a relationship; but the evidence of an independent origin is so strong that it must be supposed that the tracheæ have been independently developed in the two classes. The most important points of difference are—the separation of head and thorax in the Insecta, the mode of development of the eyes, the presence in the Arachnida of an extensive "liver," and (perhaps) the endodermal origin of the Malpighian tubes in the latter class.

Resemblances between *Limulus* and the Scorpions are readily apparent. In both there is a cephalothorax bearing six pairs of appendages, together with two median and several lateral eyes. The appendages in both are all originally post-oral, the first

¹ The *Xiphosura*, and also the *Pentastomida*, though not air-breathing, are discussed here.

pair becoming pre-oral in course of growth, and the ganglia belonging to it coalescing with the brain. The upper lip between the bases of these appendages is similarly developed in both. The pair of processes situated behind the sixth pair of appendages, which in *Limulus* form the chilaria, are represented in the Scorpions by a small pentagonal plate in front of the operculum. The abdomen of *Limulus* corresponds to the pre- and post-abdomen of the Scorpion; it contains only eight segments, inclusive of the telson; but there is evidence, from a comparison with certain fossil forms, that the telson represents several united metameres. A certain amount of correspondence is also traceable in the appendages of the abdomen. In both the first pair form the operculum; in the Scorpion the second pair form the pectines, while the rest disappear; in *Limulus* all persist as the lamelliform appendages to which the book-gills are attached. In structure there is considerable similarity between the book-gills of *Limulus* and the book-lungs of the Scorpion, but how far they are equivalent to one another remains doubtful in view of the difference in their position, the book-gills being attached to the dorsal surface of the abdominal appendages and the book-lungs sunk within the segments.

The presence in both of the large "liver," the presence of a circum-oesophageal artery, of a cartilaginous endosternite, and of a pair of coxal glands on the basal joints of the fifth pair of appendages, are some of the points of correspondence in the internal anatomy.

While *Limulus* is thus closely related to the Scorpions on the one hand, it exhibits, on the other, indications of affinities with the Trilobites, a group of extinct Arthropods probably finding their nearest existing allies in the Branchiopod Crustacea (p. 556). This resemblance to the Trilobites is most marked in the stage—the trilobite-stage—in which the young King-crab escapes from the egg. Certain fossil representatives of the Xiphosura come still nearer to the Trilobites than the adult *Limulus*, and thus increase the probability that there is a genetic connection between the two groups.

It seems probable that the air-breathing Arachnida were derived through *Limulus*-like ancestors from primitive Crustacea, and that the tracheæ were developed without genetic relationship with those of the other air-breathing groups—perhaps as modifications of the pulmonary sacs, the latter having been originally derived from gills like those of *Limulus*. That air-tubes can be developed in air-breathing members of what are, fundamentally, aquatic groups is shown by the case of certain terrestrial Isopoda among the Crustacea (p. 580).

There is a very evident close relationship between the Myriapoda, *i.e.*, the Progoneata, and the Insecta. The Insects are more highly specialised, and have their structure modified in adaptation to a

special mode of locomotion, but the resemblances in many respects are very strong. One of the most striking points of difference is the indefiniteness in the number of the segments in the Myriapoda, and their constant and definite arrangement in the Insecta. The well-defined thorax of the Insects is wanting in the Myriapods in general, but certain of the segments following the head differ from the rest in various respects, and might be looked upon as constituting a thoracic region. The presence in both groups of a sharply marked-off head bearing antennæ and jaws is an important point of resemblance; so is the absence in both of the voluminous "liver" of the Crustacea and Arachnida. The gap between the two classes is narrowed by two converging groups—the Symphyla

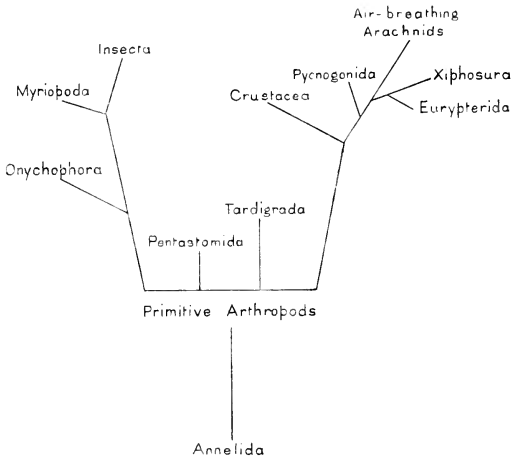

FIG. 571.

among the Myriapoda on the one hand, and the wingless—and in other respects primitive—Apterygota among the Insecta on the other.

While the Insecta thus appear to be nearly related to the Progoneata, there are indications of relationship between the Opisthogeneata and the Onychophora, and, through these, to the Chætopoda. The elongated, homonomously segmented body, the well-defined head with its antennæ, the occurrence of similar appendages on all the body-segments, all point in this direction. Accordingly, instead of placing the branchiate Arthropoda in one group and all the air-breathing forms in another, and deriving the latter from the former, we should probably express more correctly the affinities

of the various groups of Arthropods by some such scheme as that expressed in the diagram (Fig. 571).

Here an intermediate link between Annelida and the existing Arthropoda is supposed to have been constituted by hypothetical primitive forms from which Peripatus, the Insecta, and the Myriapoda are supposed to have been evolved in the one direction, and the Crustacea, Eurypterida, Xiphosura, and air-breathing Arachnida in the other.

On account mainly of general resemblances to the Spiders, the Pycnogonida have frequently been grouped with the Arachnida, and attempts have been made to homologise their appendages with those of the Spiders and Scorpions. There is at least one pair more in the Pycnogonida; and either the last pair would have to be set down as corresponding to the vestigial first abdominal pair of the ordinary Arachnida, or the ovigerous legs would have to be reckoned, not as independent appendages, but as parts of the second pair, a view for which there is some ground. A close relationship with the Arachnida, however, cannot be traced, and their affinities are perhaps best expressed, as in the diagram, by connecting them with the Arachnid branch of the Arthropod tree at a point below that at which the air-breathing forms had become developed from forms allied to the Xiphosura.

The position of the Pentastomida is a matter of uncertainty. In the absence of organs of respiration and excretion, the only feature in the adult which distinctly points to arthropod affinities is the striated character of the muscular tissue. The presence of two pairs of legs in the larva, however, is sufficient to confirm the view that they are aberrant and probably degenerate Arthropods, while leaving it uncertain in what class they find their nearest allies. The Tardigrada are still more aberrant in some respects. They differ from Arthropods in general in the absence of external segmentation in the adult state, in the simple unjointed character of the appendages, in the absence of striation in the muscular fibres, and in the absence of organs of respiration and circulation. It is impossible to place them in any of the great classes, and they are perhaps best looked upon as a special offset of the Arthropod tree given off near the base.

SECTION XII

PHYLUM MOLLUSCA

THE Mollusca, like the Arthropoda, form one of the chief divisions of the animal kingdom, both as regards diversity of organisation and number of genera and species. They are sharply distinguished from Arthropods by the absence of segmentation, and by having, as a rule, an exoskeleton in the form of a *shell*, usually external, sometimes internal. An enumeration of the Classes of the Phylum will serve to give some notion of its extent.

Class 1.—PELECYPODA, including the bivalved shell-fish, such as Mussels, Cockles, Oysters, &c.

Class 2.—AMPHINEURA, including the Chitons and their allies.

Class 3.—GASTROPODA, including the univalved shell-fish, such as Periwinkles, Whelks, Snails, Slugs, &c.

Class 4.—SCAPHOPODA, including the Tooth-shells.

Class 5.—CEPHALOPODA, including the Cuttle-fishes, Squids, Octopods, and Nautili.

CLASS I.—PELECYPODA.

1. EXAMPLE OF THE CLASS—THE FRESH-WATER MUSSELS (*Anodonta* and *Unio*).

Fresh-water Mussels are found in rivers and lakes in most parts of the world. *Anodonta cygnea*, the Swan-mussel, is the commonest species in England; but the Pearl-mussel, *Unio margaritifera*, is found in mountain streams, and other species of the same genus are universally distributed.

The Mussel (Fig. 572) is enclosed in a brown shell formed of two separate halves or *valves* hinged together along one edge. It lies on the bottom, partly buried in the mud or sand, with the valves slightly gaping, and in the narrow cleft thus formed a delicate, semi-transparent substance (*m.*) is seen—the edge of the *mantle* or *pallium*. The mantle really consists of separate halves or *lobes* corresponding with the valves of the shell, but in the position of rest the two lobes are so closely approximated as to appear simply like a membrane uniting the valves. At one end, however, the mantle projects between the valves in the form of two short

tubes, one (*ex. sph.*) smooth-walled, the other (*in. sph.*) beset with delicate processes or *fimbriæ*. By diffusing particles of carmine or indigo in the water it can be seen that a current is always passing in at the fimbriated tube, hence called the *inhalant siphon*, and out at the smooth or *exhalant siphon*. Frequently a semi-transparent, tongue-like body (*ft.*) is protruded between the valves at the opposite side from the hinge and at the end furthest from the siphons: this is the *foot*; by its means the animal is able slowly to plough its way through the sand or mud. When the Mussel is irritated the foot and siphons are withdrawn and the valves tightly closed. In a dead animal, on the other hand, the shell always gapes, and it can then be seen that each valve is lined by the corresponding lobe of the mantle, and that the exhalant siphon is formed by the union of the lobes above and below it and is thus an actual tube; but

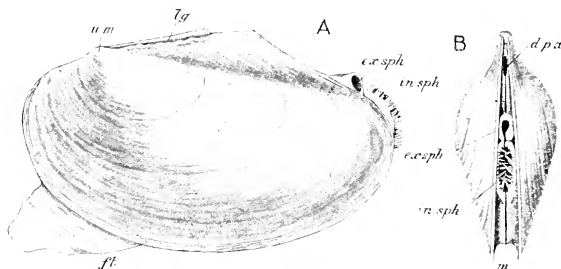

FIG. 572.—*Anodonta cygnea*. The entire animal. *A*, from the left side; *B*, from the posterior end. *d. p. a.* dorsal pallial aperture; *ex. sph.* exhalant siphon; *ft.* foot; *in. sph.* inhalant siphon; *lg.* ligament; *m.* mantle; *um.* umbo. (After Howes.)

that the boundary of the inhalant siphon facing the gape of the shell is simply formed by the approximation of the mantle-lobes, so that this tube is a temporary one.

The hinge of the shell is dorsal, the gape ventral, the end bearing the siphons posterior, the end from which the foot is protruded anterior: hence the valves and mantle-lobes are respectively right and left.

In a dead and gaping Mussel the general disposition of the parts of the animal is readily seen. The main part of the body lies between the dorsal ends of the valves: it is produced in the middle ventral line into the keel-like foot, and on each side, between the foot and the corresponding mantle-lobe, are two delicate, striated plates, the *gills* (Figs. 576-578). Thus the whole animal has been compared to a book, the back being represented by the hinge, the covers by the valves, the fly-leaves by the mantle lobes, the first two and the last two pages by the gills, and the remainder of the leaves by the foot.

The shell.—When the body of the mussel is removed from

the shell the two valves are seen to be united, along a straight *hinge-line* (Fig. 573, *A*, *h.l.*), by a tough, elastic substance, the *hinge-ligament* (Figs. 572 and 578, *lg.*) passing transversely from valve to valve. It is by the elasticity of this ligament that the shell is opened: it is closed, as we shall see, by muscular action: hence the mere relaxation of the muscles opens the shell. In Anodonta the only junction between the two valves is afforded by the ligament, but in

Unio each is produced into strong projections and ridges, the *hinge-teeth*, separated by grooves or sockets, and so arranged that the teeth of one valve fit into the sockets of the other.

The valves are marked externally by a series of concentric lines (Fig. 572) parallel with the free edge or gape, and starting from a swollen knob or elevation, the *umbo* (*um.*), situated towards the anterior edge of the hinge-line. These lines are *lines of growth*. The shell is

thickest at the umbo, which represents the part first formed in the young animal, and new layers are deposited under this original portion, as secretions from the mantle. As the animal grows each layer projects beyond its predecessor, and in this way successive outcrops are produced giving rise to the markings in question. In the region of the umbo the shell is usually more or less eroded by the action of the carbonic acid in the water.

The inner surface of the shell also presents characteristic markings (Fig. 573, *A*). Parallel with the gape and at a short distance from

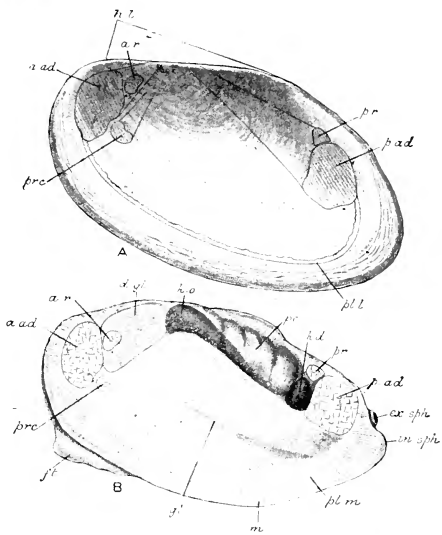

FIG. 573.—*Anodonta cygnea*. *A*, interior of right valve; *B*, the animal removed from the shell. *a. ad.* anterior adductor or its impression; *a. r.* anterior retractor or its impression; *d. gl.* digestive gland, seen through mantle; *ex. sph.* exhalant siphon; *ft.* foot; *gl.* gills, seen through mantle; *h. l.* hinge-line; *in. sph.* inhalant siphon; *k. d.* kidney, seen through mantle; *Ke. o.* Keber's organ, seen through mantle; *m.* mantle; *p. ad.* posterior adductor or its impression; *p. c.* pericardium, seen through mantle; *p. l. l.* pallial line; *p. l. m.* pallial muscles; *p. r.* posterior retractor or its impression; *p. r. c.* protractor or its impression.

it is a delicate streak (*pl. l.*) caused by the insertion into the shell of muscular fibres from the edge of the mantle: the streak is hence called the *pallial line*. Beneath the anterior end of the hinge the pallial line ends in an oval mark, the *anterior adductor impression* (*a. ad.*), on to which is inserted one of the muscles which close the shell. A similar but larger *posterior adductor impression* (*p. ad.*) lies beneath the posterior end of the hinge. Two smaller markings in close relation with the anterior adductor impression mark the insertion of the *anterior retractor* (*a. r.*), and of the *protractor* (*prc.*) of the foot: one connected with the posterior adductor impression is that of the *posterior retractor* (*p. r.*). From all these impressions faint converging lines can be traced to the umbo: they mark the gradual shifting of the muscles during the growth of the animal.

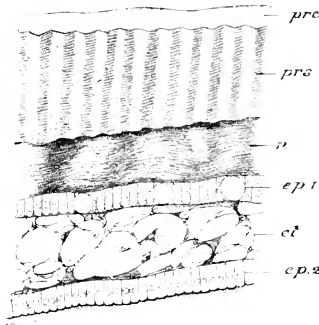

FIG. 574.—Vertical section of shell and mantle of *Anodonta*. *ct.*, connective-tissue layer of mantle; *ep. 1*, its outer epithelium; *ep. 2*, its inner epithelium; *n.*, nacreous layer of shell; *prc.*, periostracum; *prs.*, prismatic layer. (After Claus.)

The shell consists of three layers. Outside is a brown horn-like layer, the *periostracum* (Fig. 574, *prc.*), composed of *conchiolin*, a substance allied in composition to chitin. Beneath this is a *prismatic layer* (*prs.*) formed of minute prisms of calcium carbonate separated by thin layers of conchiolin; and, lastly, forming the internal part of the shell is the *nacre* (*n.*), or “mother-of-pearl,” formed of alternate layers of carbonate of lime and conchiolin arranged parallel to the surface. The perio-

stracum and the prismatic layer are secreted from the edge of the mantle only, the pearly layer from the whole of its outer surface. The hinge-ligament is continuous with the periostracum, and is to be looked upon simply as a median uncalcified portion of the shell, which is therefore, in strictness, a single continuous structure.

By the removal of the shell the **body** of the animal (Fig. 573, *B*) is seen to be elongated from before backwards, narrow from side to side, produced on each side into a mantle-lobe (*m.*) and continued ventrally into a keel-like *visceral mass* (Fig. 575, *v.m.*), which passes below and in front into the foot (*ft.*). Thus each valve of the shell is in contact with the dorso-lateral region of the body of its own side together with the corresponding mantle-lobe, and it is from the epithelium (Fig. 574, *ep. 1*) covering these parts that the shell is formed as a cuticular secretion. The whole space

between the two mantle-lobes, containing the gills, visceral mass, and foot, is called the *mantle-cavity*.

A single layer of epithelial cells covers the whole external surface, *i.e.* the body proper, both surfaces of the mantle, the gills, and foot; that of the gills and of the inner surface of the mantle (Fig. 574, *cp. 2*) is ciliated. Beneath the epidermis come connective and muscular tissue, which occupy nearly the whole of the interior of the body not taken up by the viscera, the *cœlome* being, as we shall see, much reduced. The **muscles** are all unstriped, and are arranged in distinct bands or sheets, many of them very large and conspicuous. The largest are the *anterior* and *posterior adductors* (Figs. 573 and 575, *a. ad.*, *p. ad.*), great cylindrical muscles, passing transversely across the body and inserted at either end on to

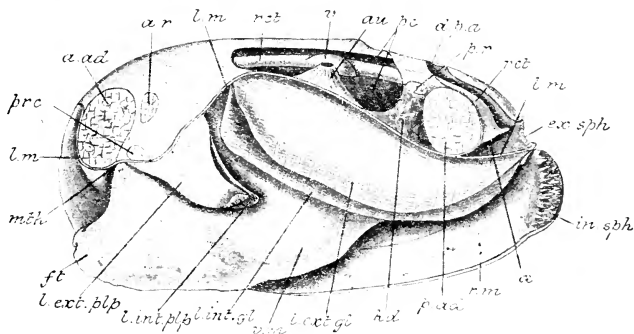

FIG. 575.—*Anodonta cygnea*. The animal with most of the left mantle-lobe removed. *a.* anus; *a. ad.* anterior adductor; *a. r.* anterior retractor; *au.* auricle; *d. p. a.* dorsal pallial aperture; *ex. sph.* exhalant siphon; *ft.* foot; *in. sph.* inhalant siphon; *kd.* kidney; *l. ext. gl.* left external gill-lamina; *l. ext. plp.* left external labial palp; *l. int. gl.* left internal gill-lamina; *l. int. plp.* left internal labial palp; *l. m.* cut edge of left mantle-lobe; *mt.* mouth; *p. ad.* posterior adductor; *pc.* pericardium; *p. r.* posterior retractor; *prc.* protractor; *rct.* rectum; *r. m.* right mantle-lobe; *v.* ventricle; *v. m.* visceral mass.

the valves of the shell, which are approximated by their contraction. Two muscles of much smaller size pass from the foot to the shell, which they serve to draw back; they are the *anterior* (*a. r.*) and *posterior* (*p. r.*) retractors. A third muscle (*prc.*), inserted on to the shell, close to the anterior adductor, has its fibres spread fan-wise over the visceral mass, which it serves to compress, thus forcing out the foot and acting as a *protractor* of that organ. The substance of the foot itself consists of a complex mass of fibres, the *intrinsic muscles* of the foot, many of which also act as protractors. Lastly, all along the border of the mantle is a row of delicate *pallial muscles* (Fig. 573, *pl. m.*), which, by their insertion into the shell, give rise to the pallial line already seen.

The *cœlome* is reduced to a single ovoidal chamber, the *pericardium* (Fig. 575, *pc.*), lying in the dorsal region of the body and

containing the heart and part of the intestine; it is lined by cœlomic epithelium. In the remainder of the body the space between the ectoderm and the viscera is filled by the muscles and connective-tissue.

Digestive organs.—The *mouth* (Fig. 575, *mth.*) lies in the middle line, just below the anterior adductor. On each side of it are two triangular flaps, the *internal* and *external labial palps* (*l. int. plp.*, *l. ext. plp.*); the external palps unite with one another in front of the mouth, forming an upper lip; the internal palps are similarly united behind the mouth, forming a lower lip; both are ciliated externally. The mouth leads by a short *gullet* (Fig. 576, *gul.*) into a large *stomach* (*st.*), which receives the ducts (*d.d.*) of a

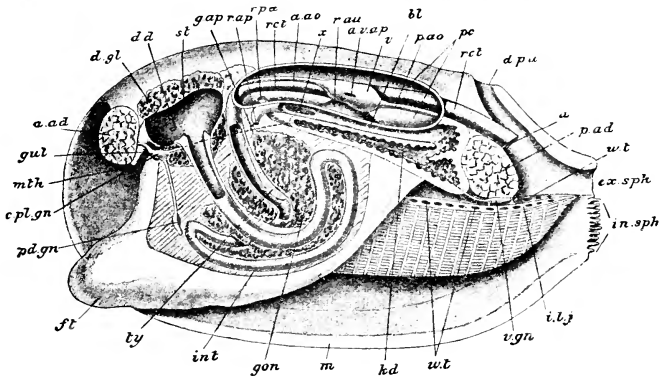

FIG. 576.—*Anodonta cygnea*. Dissection from the left side. *a.* anus; *a. ad.* anterior adductor; *a. ao.* anterior aorta; *a. r. ap.* auriculo-ventricular aperture; *bl.* urinary bladder; *c. pl. gn.* cerebro-pleural ganglion; *d. d.* duct of digestive gland; *d. gl.* digestive gland; *d. p. a.* dorsal pallial aperture; *ex. sph.* exhalant siphon; *ft.* foot; *g. ap.* genital aperture; *gon.* gonad; *gul.* gullet; *i. l. j.* inter-lamellar junction; *in. sph.* inhalant siphon; *int.* intestine; *kd.* kidney; *m.* mantle; *mth.* mouth; *p. ao.* posterior aorta; *p. ad.* posterior adductor; *pc.* pericardium; *pd. gn.* pedal ganglion; *r. ap.* renal aperture; *r. au.* right auricle; *rct.* rectum; *r. p. a.* reno-pericardial aperture; *st.* stomach; *ty.* typhlosole; *v.* ventricle; *v. gn.* visceral ganglion; *w. t.* water tubes; *x.* aperture between right and left bladders.

pair of irregular, dark-brown *digestive glands* (*d.gl.*). The *intestine* (*int.*) is given off from the posterior end of the stomach, descends into the visceral mass, where it is coiled upon itself, then ascends parallel to its first portion, turns sharply backwards, and proceeds, as the *rectum* (*rct.*), through the pericardium—where it traverses the ventricle of the heart—and above the posterior adductor, finally discharging by the *anus* (*a.*) into the exhalant siphon, or cloaca. The wall of the rectum is produced into a longitudinal ridge, or *typhlosole* (*ty.*), like that of the Earthworm, and two similar ridges begin in the stomach and are continued into the first portion of the intestine. The stomach contains, under certain conditions, a gelatinous rod, the *crystalline style*.

On each side is a single gill or **ctenidium** composed of two plates or *laminae*, an inner and an outer. We have thus right outer and inner gill-laminae, and left outer and inner gill-laminae (Fig. 575, *l. ext. gl.*, *l. int. gl.*). Seen from the surface, each lamina presents a delicate double striation, being marked by faint lines running parallel with, and by more pronounced lines running at right angles to, the long axis of the organ. Moreover, each lamina is

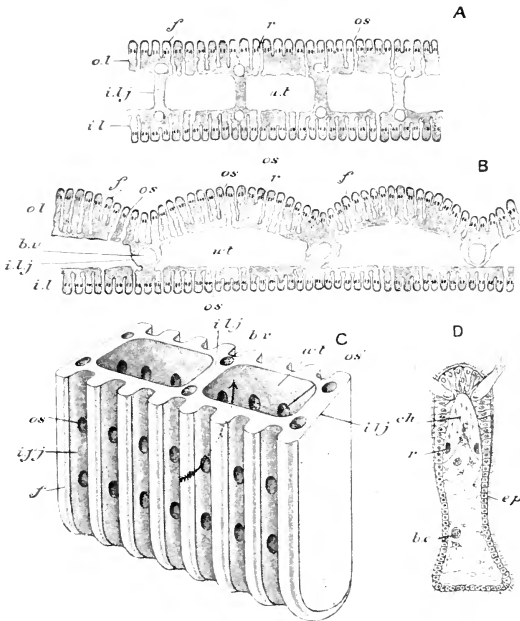

FIG. 577.—**Anodonta cygnea.** A, transverse section of outer, and B, of inner gill-lamina; C, diagram of gill-structure; D, transverse section of gill filament. *b. c.* blood-corpuscle; *b. v.* blood-vessels; *ch.* chitin; *f.* branchial filaments; *ep.* epithelium; *i. f. j.* inter-filamentary junction; *i. l. j.* inter-lamellar junction; *o. l.* outer lamella; *os.* external ostium; *os'* internal ostium; *r.* chitinous rods; *u. t.* water-tubes. (A, B, and D after Peck.)

double, being formed of two similar plates, the *inner* and *outer lamella*, united with one another along the anterior, ventral, and posterior edges of the lamina, but free dorsally. The lamina has thus the form of a long and extremely narrow bag open above (Figs. 576, 577, and 578): its cavity is subdivided by vertical bars of tissue, the *inter-lamellar junctions* (*i. l. j.*), which extend between the two lamellae, and divide the intervening space into distinct compart-

ments or *water-tubes* (*w.t.*), closed ventrally, but freely open along the dorsal edge of the gill. The vertical striation of the laminae is due to the fact that each lamella is made up of a number of close-set *gill-filaments* (*f.*): the longitudinal striation to the circumstance that these filaments are connected by horizontal bars, the *inter-*

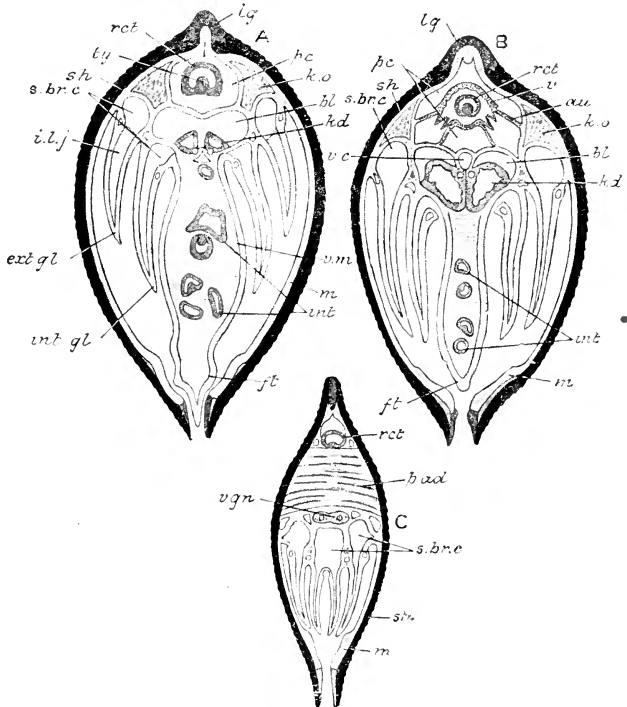

FIG. 578.—*Anodonta cygnea*. Three transverse sections, A, B, C, *au*, auricle; *bl*, urinary bladder; *ext. gl.*, external gill-lamina; *ft*, foot; *i.l.j.*, inter-lamellar junction; *int.*, intestine; *int. gl.*, internal gill-lamina; *kd*, kidney; *k.o.*, Keber's organ; *lg*, ligament; *m*, mantle; *p.ad.*, posterior adductor; *pc*, pericardium; *ret.*, rectum; *s.br.c.*, supra-branchial chamber; *sh*, shell; *ty*, typhlosole; *v*, ventricle; *v.c.*, vena cava; *v.gn.*, visceral ganglion. (After Howes, slightly altered.)

filamentar junctions (*i. f. j.*). At the thin free or ventral edge of the lamina the filaments of the two lamellæ are continuous with one another, so that each lamina has actually a single set of V-shaped filaments, the outer limbs of which go to form the outer lamella, their inner limbs the inner lamella. Between the filaments, and

bounded above and below by the inter-filamentar junctions, are minute apertures, or *ostia* (*os.*), which lead from the mantle-cavity through a more or less irregular series of cavities into the interior of the water-tubes. The filaments themselves are supported by chitinous rods (*r.*), and are covered with ciliated epithelium, the large cilia (Fig. 577, *D*) of which produce a current running from the exterior through the ostia into the water-tubes, and finally escaping by the wide dorsal apertures of the latter. The whole organ is traversed by blood-vessels (*b. v.*).

The mode of attachment of the gills presents certain features of importance. The outer lamella of the outer lamina is attached along its whole length to the mantle (Fig. 578): the inner lamella of the outer and the outer lamella of the inner lamina are attached together to the sides of the visceral mass a little below the origin of the mantle: the inner lamella of the inner lamina is also attached to the visceral mass in front (*A*), but is free further back (*B*). The gills are longer than the visceral mass, and project behind it, below the posterior adductor (*C*), as far as the posterior edge of the mantle: in this region the inner lamellæ of the right and left inner laminae are united with one another, and the dorsal edges of all four laminae constitute a horizontal partition between the pallial cavity below and the exhalant chamber or cloaca above. Owing to this arrangement it will be seen that the water-tubes all open dorsally into a *supra-branchial chamber* (*s. br. c.*) continuous posteriorly with the cloaca and thus opening on the exterior by the exhalant siphon.

The physiological importance of the gills will now be obvious. By the action of their cilia a current is produced which sets in through the inhalant siphon into the pallial cavity, through the ostia into the water-tubes, into the supra-branchial chamber, and out at the exhalant siphon. The in-going current carries with it not only oxygen for the aëration of the blood, but also Diatoms, Infusoria and other microscopic organisms, which are swept into the mouth by the cilia covering the labial palps. The out-going current carries with it the various products of excretion and the fæces passed into the cloaca. The action of the gills in producing the food-current is of more importance than their respiratory function, which they share with the mantle.

The **excretory organs** are the *kidneys* or *urocales* (portions of the true coelome), situated one on each side of the body just below the pericardium. Each consists of two parts, a brown spongy *glandular portion* or *kidney* (Fig. 576, *kd.*), and a thin-walled non-glandular part or *urinary bladder* (*bl.*), which communicates with its fellow anteriorly by a large oval aperture (*x*). The two parts lie parallel to one another, the bladder being placed dorsally and immediately below the floor of the pericardium: they communicate with one another posteriorly, while in front each glandular part opens into the pericardium (*r. p. ap.*), and the bladder

on to the exterior by a minute aperture (*r. ap.*), situated between the inner lamina of the gill and the visceral mass. Thus the whole organ, often called, after its discoverer, the *organ of Bojanus*, is simply a tube bent upon itself, opening at one end into the coelome, and at the other on the external surface of the body: it has thus the normal relations of a nephridium, but is of coelomic not ectodermal derivation. The epithelium of the bladder is ciliated, and produces an outward current.

An excretory function is also discharged by a large glandular mass of reddish-brown colour, called the *pericardial gland* or *Keber's organ* (Fig. 578, *B. k.o.*). It lies in the anterior region of the body just in front of the pericardium, into which it discharges.

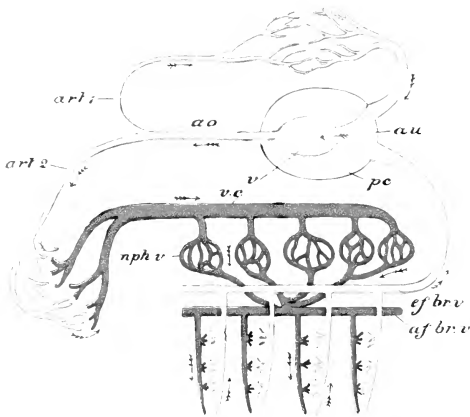

FIG. 579.—Diagram of the circulatory system of *Anodonta*. Vessels containing aerated blood red, non-aerated blue. *af.br.v.*, afferent branchial veins; *ao.*, aorta (*art. 1*, artery to mantle; *art. 2*, artery to body generally); *au.*, auricle; *ef.br.v.*, efferent branchial veins; *nph.v.*, nephridial veins; *pc.*, pericardium; *v.*, ventricle; *v.c.*, vena cava. The arrows show the direction of the current.

The **circulatory system** is well developed. The *heart* lies in the pericardium and consists of a single *ventricle* (Figs. 576, 578, and 579, *v.*) and of right and left *auricles* (*au.*). The ventricle is a muscular chamber which has the peculiarity of surrounding the rectum (Figs. 576 and 578, *B*): the auricles are thin-walled chambers communicating with the ventricle by valvular apertures opening towards the latter. From each end of the ventricle an artery is given off, the *anterior aorta* (Fig. 576, *a. ao.*) passing above, the *posterior aorta* (*p. ao.*) below the rectum. From the aorta the blood passes into arteries (Fig. 579, *art. 1 art. 2*) which ramify all over the body, finally forming an extensive network of vessels, many

of which are devoid of proper walls and have therefore the nature of sinuses. The returning blood passes into a large longitudinal vein, the *vena cava* (*v. c.*), placed between the nephridia, whence it is taken to the kidneys themselves (*nph. v.*), thence by *afferent branchial veins* (*af. br. v.*) to the gills, and is finally returned by *effluent branchial veins* (*ef. br. v.*) to the auricles. The mantle has a very extensive blood supply, and, as mentioned above, probably acts as the chief respiratory organ: its blood (*art. I*) is returned directly to the auricles without passing through either the kidneys or the gills. The blood is colourless and contains leucocytes.

The **nervous system** is formed on a type quite different from anything we have yet met with. On each side of the gullet is a small *cerebro-pleural ganglion* (Fig. 576, *c. pl. gn.*) united with its fellow of the opposite side by a nerve-cord, the *cerebral commissure*, passing above the gullet. Each cerebro-pleural ganglion also gives off a cord, the *cerebro-pedal connective*, which passes downwards and backwards to a *pedal ganglion* (*pd. gn.*) situated at the junction of the visceral mass with the foot: the two pedal ganglia are so closely united as to form a single bilobed mass. From each cerebro-pleural ganglion there further proceeds a long *cerebro-visceral connective* which passes directly backwards, through the kidney, and ends in a *visceral ganglion* (*v. gn.*) placed on the ventral side of the posterior adductor muscle. The visceral, like the pedal ganglia, are fused together. The cerebro-pleural ganglia supply the labial palps and the anterior part of the mantle; the pedal the foot and its muscles; the visceral the enteric canal, heart, gills, and posterior portion of the mantle.

It will be seen that the cerebral commissures and cerebro-pedal connectives, together with the cerebro-pleural and pedal ganglia, form a nerve-ring which surrounds the gullet: the cerebro-pleural ganglia may be looked upon as a supra-oesophageal nerve mass corresponding in part with the brain of Annelids and Arthropods, and the pedal ganglia as an infra-oesophageal mass representing the ventral nerve-cord.

Sensory organs are poorly developed, as might be expected in an animal of such sedentary habits. In connection with each visceral ganglion is a patch of sensory epithelium forming the so-called olfactory organ or, better, *osphradium*, the function of

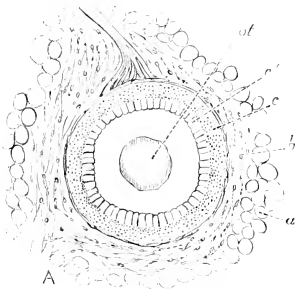

FIG. 580.—Statocyst of *Anodonta*. *a, b, c, c'*, cellular layers surrounding the statocyst; *st*, statolith. (From the *Cambridge Natural History*.)

which is apparently to test the purity of the water entering by the respiratory current. Close to each pedal ganglion a minute *statocyst* ("otocyst") (Fig. 580) is sometimes found, the nerve of which is said to spring from the cerebro-pedal connective, being probably derived from the cerebral ganglion. Sensory cells—probably tactile—also occur round the edge of the mantle, and especially on the fimbriæ of the inhalant siphon.

Reproductive organs.—The sexes are separate. The gonads (Fig. 576, *gon.*) are large, paired, racemose glands, occupying a considerable portion of the visceral mass amongst the coils of the intestine: the testis is white, the ovary reddish. The gonad of each side has a short duct which opens (*g. ap.*) on the surface of the visceral mass just in front of the renal aperture.

In the breeding season the eggs, extruded from the genital

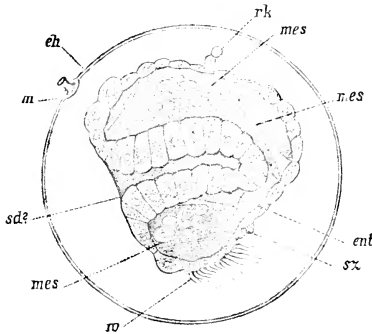

FIG. 581.—Early embryo of *Anodonta*. *ch*, vitelline-membrane; *ent*, archenteron; *m*, micropyle; *mes*, mesoderm; *rk*, polar cells; *sd?*, shell-gland; *sz*, lateral cells; *w*, cilia. (From Korschelt and Heider's *Embryology*.)

aperture, pass into the supra-branchial chamber and so to the cloaca. There, in all probability, they are impregnated by sperms introduced with the respiratory current. The oosperms are then passed into the cavities of the outer gill-laminae, which they distend enormously. Thus the outer gill-laminae act as brood-pouches, and in them the embryo develops into the peculiar larval form presently to be described.

Development.—Segmentation of the oosperm is complete, but unequal. A gastrula is formed by the invagination of the megameres into the micromeres, but the archenteron (Fig. 581, *ent.*) thus formed is quite small and insignificant, and has no physiological importance until a late period of larval life. Certain of the cells of the gastrula are budded off into the blastocœle, where they accumulate and form the mesoderm (*mes.*). At about the same time a deep invagination (*sd?*) is formed, which might easily be mistaken for the archenteron, but is really a very characteristic molluscan organ, the *shell-gland*: it marks the dorsal surface of the embryo. The posterior end is distinguished by a tuft of long cilia.

The shell-gland becomes converted into a plate of long, cylindrical cells (Fig. 582, *sd.*), from which an *unpaired* shell (*s.*) is secreted. This is replaced before long by a bivalved shell of triangular form, its ventral angles produced into incurved hooks

beset with spines (Fig. 583, *sh*). At the same time the body of the larva, which has hitherto been an undivided mass projecting between the two valves of the shell, becomes cleft from below upwards, and thus divided into a single dorsally-placed body

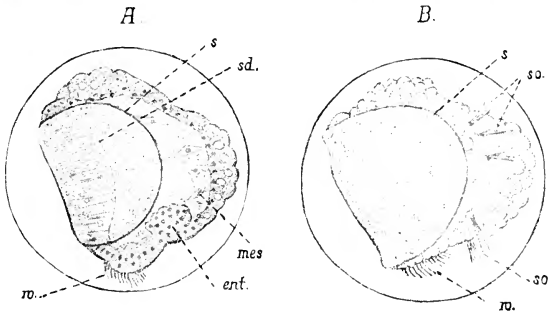

FIG. 582.—Two later stages in the development of **Anodonta**. *ent.* archenteron; *mes.* mesoderm; *s.* shell; *sd.* shell-gland; *so.* sense-organs; *w.* cilia. (From Korschelt and Heider's *Embryology*.)

proper, and paired—right and left—mantle-lobes. Upon the latter peculiar brush-like sense-organs make their appearance, and on the ventral surface of the body is formed a glandular pouch, which secretes a long thread, the *provisional byssus* (*f*). The mesoderm

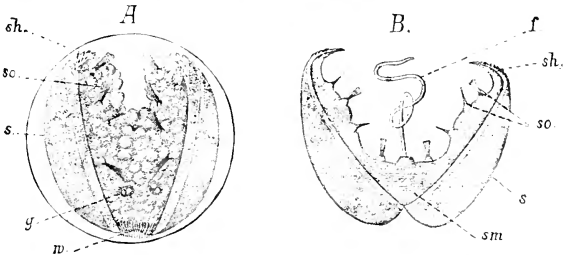

FIG. 583.—A, advanced embryo of **Anodonta**. B, free glochidium. *f.* provisional byssus; *s.* shell; *sh.* hooks; *sm.* adductor muscle; *so.* sense-organs; *w.* cilia. (From Korschelt and Heider's *Embryology*.)

cells give rise to a single immense adductor muscle (*sm*), the fibres of which extend from valve to valve.

The larva is now called a *glochidium*: it remains in the brood-pouch, nourished by a secretion from the walls of the latter, and entangled with its fellows by means of the byssus. At this stage the outer gill-lamina appears as if stuffed full of closely aggregated sand-grains. Before long the larvae are ejected

through the exhalant siphon, and if they happen to come in contact with a passing Stickleback or other fresh-water fish, fix themselves on some part of its body by means of the hooked valves. The glochidia of *Unio* usually attach themselves to the gills, those of *Anodonta* to the skin or the fins. In this position

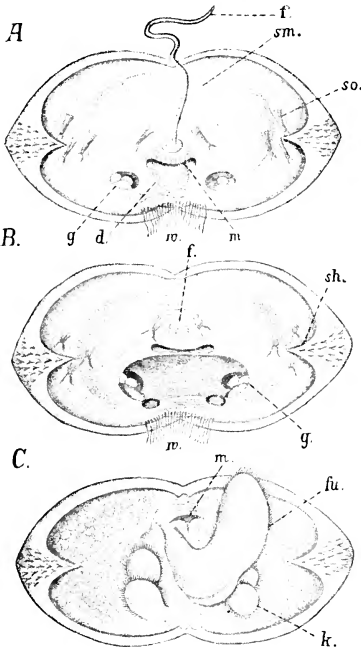

FIG. 584.—Three stages in the metamorphosis of *Anodonta*. *d.* enteric canal; *f.* provisional byssus; *fu.* foot; *g.* lateral pits; *k.* rudiments of gills; *m.* mouth; *sh.* shell; *sm.* adductor muscle; *so.* sense-organs; *w.* cilia. (From Korschelt and Heider's *Embryology*.)

they become encysted by an overgrowth of the skin or mucous membrane of the host, and are nourished by its juices absorbed through processes of the mantle. They thus lead a truly ectoparasitic existence for about ten weeks.

While in this condition a metamorphosis takes place. The provisional byssus and sense-organs disappear (Fig. 584), and immediately posterior to the former an invagination, the *stomodæum* (*m*), is formed, and soon communicates with the archenteron. The posterior end of this cavity is in close contact with the ectoderm, so that the anus is formed by a simple process of rupture, and without the development of a proctodæum.

The foot (*fu*) arises as a median ventral elevation behind the mouth, and on each side of it two

papillæ (*k*) appear, the rudiments of the gills. The larva is now fitted for free existence; it drops from its host, and gradually assumes the adult form and mode of life.

2. DISTINCTIVE CHARACTERS AND CLASSIFICATION.

The Pelecypoda are bilaterally symmetrical, compressed Molluscs, in which the mantle consists of paired right and left lobes, secreting a bivalved calcareous shell. There is no distinct head. The ventral region of the body is differentiated into a muscular foot,

which is usually ploughshare- or tongue-shaped: in some cases there is a *byssus-gland* posterior to the foot, which secretes a mass of horny fibres, the *byssus*, by which the animal may be permanently attached. There are two gills or *ctenidia*, one on each side: the chief function of the gills is the production of a respiratory and food-carrying current of water. The body is covered by a one-layered epidermis, which is ciliated on the gills and on the inner surface of the mantle. The muscular system is well-developed, the largest muscles being either one or two adductors, which close the shell, and several bands connected with the foot and byssus; the muscles are usually unstriped. The coelome is reduced to a dorsally-placed pericardium. The mouth is bounded by two pairs of flat, triangular tentacles or labial palps, the cilia of which serve to carry food-particles to the mouth: the enteric canal is coiled, and is formed mainly from the mesenteron: there are large paired digestive glands: the rectum passes through the pericardium, usually perforates the ventricle, and ends above the posterior adductor. The heart is contained within the pericardium, and consists of a median ventricle and of right and left auricles: the blood, which is usually colourless, is taken from the ventricle to the body by one or two aortæ, and is returned partly directly, partly by way of the renal organs and gills, to the auricles. The renal organs are a single pair of coelomic kidneys, which usually open at one end into the pericardium, at the other on the exterior. The nervous system consists typically of four pairs of ganglia called respectively cerebral, pleural, pedal, and visceral: the cerebral and pleural of each side are usually fused into a single cerebro-pleural ganglion. The chief sense-organs are statocysts and osphradia or water-testing organs. The sexes are separate or united: there are no accessory organs of reproduction. Development is accompanied by a metamorphosis, which usually includes a trochophore stage.

The classification of the Pelecypoda is as follows:—

ORDER 1.—PROTOBRANCHIA.

Pelecypoda in which the gills take the form of a single pair of plume-like organs or ctenidia, each with two rows of flattened gill-filaments. The foot is not compressed, but has a flattened ventral surface or sole upon which the animal creeps. There are two adductor muscles.

This group includes only four genera—*Nucula* (Fig. 596), *Yoldia*, *Leda*, and *Solenomya*.

ORDER 2.—FILIBRANCHIA.

Pelecypoda in which there is a pair of plate-like gills formed of distinct V-shaped filaments: interfilamentar junctions are either

absent or formed by groups of interlocking cilia: interlamellar junctions are either absent or non-vascular. As a rule there are two adductor muscles, but the anterior may be greatly reduced or absent.

Including the Noah's ark shell (*Arca*), Sea-mussel (*Mytilus*, Fig. 595), *Anomia*, *Trigonia*, &c.

ORDER 3.—PSEUDO-LAMELLIBRANCHIA.

Pelecypoda in which the gills are plaited so as to present vertical folds: the interfilamentar junctions may be ciliary or vascular: the interlamellar junctions vascular or non-vascular. There is a single large (posterior) adductor muscle. The shell is frequently inequivalve.

Including the Scallop (*Pecten*, Fig. 585), Oyster (*Ostrea*), Pearl Oyster (*Meleagrina*), *Lima*, *Pinna*, &c.

ORDER 4.—EULAMELLIBRANCHIA.

Pelecypoda in which the gill-filaments are united by vascular interfilamentar and interlamellar junctions, firm, basket-like gills being the result: the gills may be smooth or plaited. There are two equal-sized adductor muscles.

Sub-order a.—Integripalliata.

Eulamellibranchia in which the siphons are small or absent and the pallial line on the shell is entire.

Including the Fresh-water mussels (*Anodonta* and *Unio*).

Sub-order b.—Sinupalliata.

Eulamellibranchia in which the siphons are of considerable size, and the pallial line is inflected to form a sinus.

Including the Cockle (*Cardium*), *Mya*, *Pholas*, *Teredo* (Ship-worm), *Aspergillum*, &c. (Figs. 587-590).

ORDER 5.—SEPTIBRANCHIA.

Pelecypoda in which the gills are reduced to a horizontal muscular partition. There are two adductor muscles.

Including *Poromya*, *Cuspidaria*, &c.

Systematic Position of the Examples.

Anodonta and *Unio* are two genera belonging to the family *Unionidae*, sub-order *Integripalliata*, order *Eulamellibranchia*.

Their complex basket-like gills are alone sufficient to place them among the Eulamellibranchia. The incomplete ventral siphon and the correlated entire pallial line (see p. 666) indicate their position among the *Integripalliata*. The regular shell, with

thick brown periostracum and large external ligament, the elongated branchial or inhalant aperture, the long, compressed foot, and the absence of a byssus, place them among the Unioniidae. Anodonta is distinguished from Unio by the absence of hinge-teeth.

3. GENERAL ORGANISATION.

The most important variations in structure in the present class are connected with modifications of the gills, the foot, the muscular system, and the siphons. With the structure of the muscles and of the siphons are correlated important variations in the shell which are of great systematic value, especially in cases where, as with fossils, the shell is the only part available for examination.

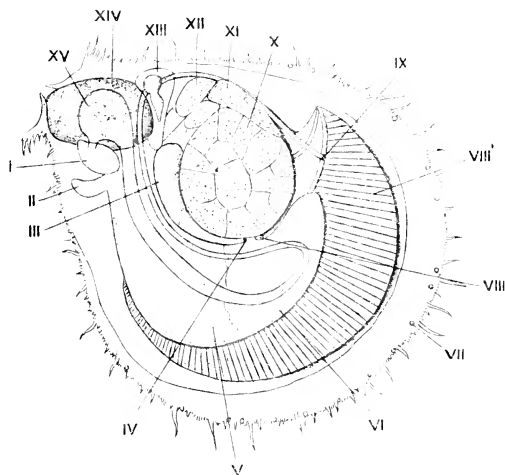

FIG. 585.—Anatomy of *Pecten*. I, palpi; II, foot; III, aperture of gonad into kidney; IV, external renal aperture; V, male, and VI, female portion of gonad; VII, pallial eye; VIII, visceral ganglion; VIII', gill; IX, anus; X, striated portion of adductor; XI, smooth portion; XII, retractor of foot; XIII, heart; XIV, liver; XV, stomach. (From Pelsencer's *Mollusques*.)

In all the Protobranchia, some of the Filibranchia, such as *Arca*, and all the Eulamellibranchia and Septibranchia, there are two almost equal-sized **adductor muscles**, as in Anodonta. In many Filibranchs, such as the common sea-mussel (*Mytilus edulis*), the anterior adductor becomes greatly reduced and the posterior correspondingly enlarged; and in another species of the same genus (*M. latus*) the anterior adductor has completely atrophied, the function of closing the shell being performed by the

great posterior adductor alone. In *Anomia* and in the *Pseudolamellibranchs* there is a single immense adductor (Fig. 585, X, XI) placed nearly in the middle of the greatly shortened body, and known to represent the posterior adductor—both from the fact that the rectum passes over it, and from the circumstance that, in the embryo *Oyster*, two adductors are present, the anterior of which atrophies, while the posterior enlarges to form the single muscle of the adult.

These peculiarities in the muscular system bear their mark upon the **shell**, in which impressions corresponding to the

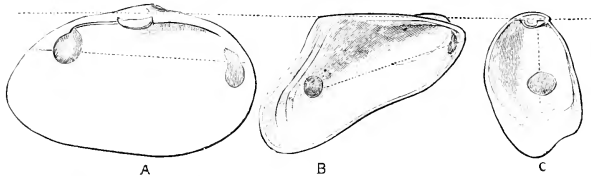

FIG. 586.—Left valves of *A, Mya*; *B, Modiola*; *C, Vulsella*. The upper dotted line passes through the hinge-lines, the lower connects the anterior and posterior adductor muscles. (From the *Cambridge Natural History*.)

adductors are clearly marked on the inner surface (Fig. 586). The whole class is, in fact, frequently classified on this basis, species with equal-sized adductors (*Protobranchs*, some *Filibranchs*, and all *Eulamellibranchs* and *Septibranchs*) being called *Isomyaria* (*A*), those with a large posterior and a reduced anterior adductor (most *Filibranchs*) *Heteromyaria* (*B*), and those with large centrally placed posterior and no anterior adductor (*Pseudolamellibranchs* and *Anomia* among *Filibranchs*) *Monomyaria* (*C*).

In many forms, such as *Nucula* (Fig. 596), *Ostrea*, &c., the right and left mantle-lobes are quite free from each other, so that there

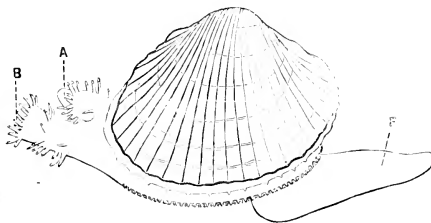

FIG. 587.—*Cardium edule*. *A*, exhalant siphon; *B*, inhalant siphon; *F*, foot. (From the *Cambridge Natural History*.)

are no **siphons**. In *Anodonta* and *Unio*, as we have seen, the two lobes unite so as to enclose a dorsal or exhalant siphon, a ventral or inhalant siphon being formed simply by apposition of the lobes ventrally. In such cases the pallial muscles in their neighbourhood act as retractors of the short and imperfect tubes thus formed. In other species a second conerescence of the mantle-lobes takes place so as to convert the inhalant siphon into an actual circumscribed

aperture or short tube. In the Sinupalliate the two siphons are prolonged into distinct muscular tubes (Fig. 587, *A*, *B*) which, in the position of extension, project beyond the posterior margin of the shell and may even be considerably longer than the body. Under these circumstances the posterior pallial muscles become enlarged to form retractors of the siphons, and the portion of the pallial line from which they arise is, as it were, pushed forwards so as to form a bay or *pallial sinus* (Fig. 588, *p.s*). Thus the shells of species with well-developed siphons are *sinupalliate*, or have an indented pallial line, while those with small or no siphons are *integripalliate*, or have an entire pallial line. The larger the siphons the stronger are their muscles and the deeper is the pallial sinus: when very large they cannot be completely retracted, and the posterior border of the shell then gapes permanently. The siphons may be separate (Fig. 589) or united (Fig. 590). They are specially adapted for species of burrowing habits, which are able to remain buried in the mud or sand, only the ends of the siphons being exposed for the supply of aerated water and food, and even these can be instantly withdrawn in the event of danger.

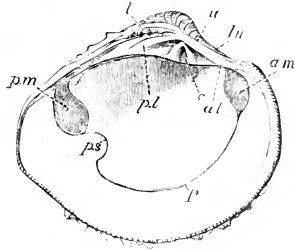

FIG. 588.—*Venus gnidia*, inner surface of left valve. *al*, anterior lateral tooth; *am*, anterior adductor impression; *c*, cardinal teeth; *l*, ligament; *lu*, lunule; *p*, pallial line; *p.l*, posterior lateral tooth; *p.m*, posterior adductor impression; *p.s*, pallial sinus; *u*, umbo. (From the *Cambridge Natural History*.)

In addition to their union posteriorly to form the siphons, the mantle-lobes may conalesce to a greater or less extent along their

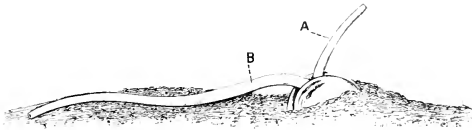

FIG. 589.—*Scrobicularia piperata*, in its natural position, partly buried in sand. *A*, exhalant siphon; *B*, inhalant siphon. (From the *Cambridge Natural History*.)

ventral border (Fig. 591), forming a more or less tubular investment for the body, and leaving an anterior *pedal aperture* for the protrusion of the foot. Their anterior portions may also be united to form a sort of hood.

To return to the **shell**, the muscular impressions and the pallial line on which have already been referred to. As a general rule the right and left valves are alike, or nearly so, the shell being

therefore *equivalve*. Each valve is *inequilateral*, being divided into unequal portions by a line drawn from the umbo to the gape. It will be remembered that in the Brachiopoda, the only other class of bivalved animals, the precise opposite is the case, the shell being equilateral and inequivalved. Some Pseudolamellibranchs are, however, nearly equilateral and markedly inequivalved, such as the scallop (*Pecten*), and the inequivalve character is still more marked in the oyster, in which the right valve is deeply concavo-convex and permanently attached to a rock, while the left is flat and forms a sort of lid. This condition of things reaches its maximum in the extinct *Hippurites* (Fig. 592, *B*), in which the left valve has the form of a long tube closed at one end by the flat lid-like right valve. In the extinct *Requienia* (*A*) the left valve is spirally coiled, so that it resembles a snail-shell, and its aperture is closed by the flat lid-like right valve: in *Diceras*, also extinct, both valves are coiled.



FIG. 590.—*Solecortus strigillatus*. *s. af*, inhalant siphon, *s. ef*, exhalant siphon, the two united at *SS.* (From the *Cambridge Natural History*.)

The hinge-teeth (Fig. 588) vary greatly in form and size or may be absent altogether: the hinge-ligament is usually band-like, but in *Pecten* takes the form of a cylindrical cord. The variations in form, ornamentation, colour, &c., among the many thousand known species of shell are too numerous to mention; but reference must be made to peculiar modifications found in certain burrowing forms. In *Pholas*, a siphonate genus which burrows in stone, the shell is weak and brittle, and additional calcareous pieces are developed between the two valves.

In *Teredo* (Fig. 593), the so-called Ship-worm, which causes great

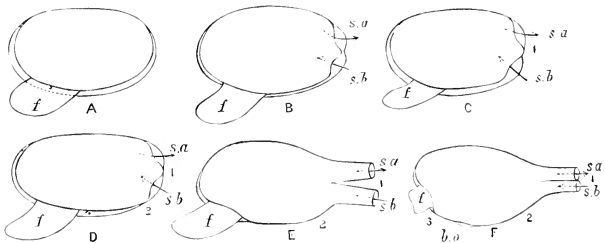

FIG. 591.—Diagram illustrating the various degrees of union of the mantle-lobes. *b.o*, byssal aperture; *f*, foot; *s. a*, exhalant siphon; *s. b*, inhalant siphon; 1, first point of union between siphons; 2, second, between inhalant siphon and foot; 3, third, between byssal aperture and foot. (From the *Cambridge Natural History*.)

destruction by boring into piles, ships' timbers, &c., the valves (V.) remain very small and weak but movable, and the general surface of the mantle secretes a continuous shelly tube which lines the burrow. In *Aspergillum* (Fig. 594), which lives buried in sand, there is a similar but wider calcareous tube, with which the valves are completely fused, and the anterior end of the tube which appears above the surface of the sand is closed by a plate perforated with numerous holes like the rose of a watering-pot. The larval shell is sometimes, though not always, distinguishable at the apex of each valve in the Pelecypoda in general.

In *Nucula*, *Arca*, &c., the foot

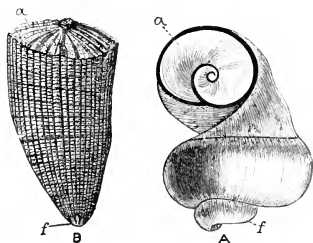

FIG. 592.—A, *Requiensia ammonica*; B, *Hippurites cornu-vaccinum*. a, right valve; f, point of fixation. (From the Cambridge Natural History.)

(Fig. 596, f.) presents what may be considered as its most primitive form, having a flat ventral surface or sole upon which the animal creeps. Far more common is the ploughshare-like form we are already familiar with in Anodonta and Unio, adapted for slowly making its way through sand or mud. In a few forms, e.g. *Trigonia* and *Cardium* (Fig. 587), it is bent upon itself and is capable of being suddenly straightened so as to act as a leaping organ: in *Mytilus* it is cylindrical (Fig. 595, F): in the Oyster it is absent. In addition to the anterior and posterior retractors and a pair of *protractors*, the foot is sometimes provided with a *levator* muscle, particularly well developed in *Nucula* and its allies.

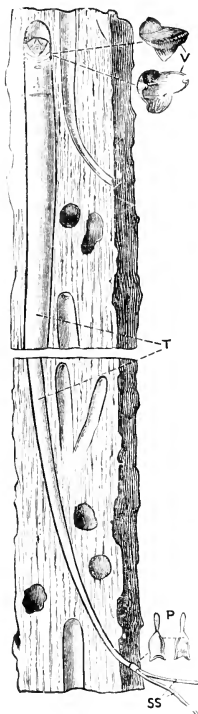

FIG. 593.—*Teredo navalis*, in a piece of timber. P, pallets (small calcareous plates supporting the siphons); SS, siphons; T, tube; V, valve of shell. (From the Cambridge Natural History.)

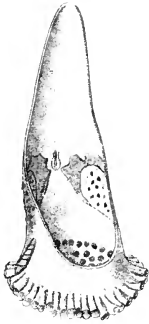

FIG. 594.—*Aspergillum*.
(After Sowerby.)

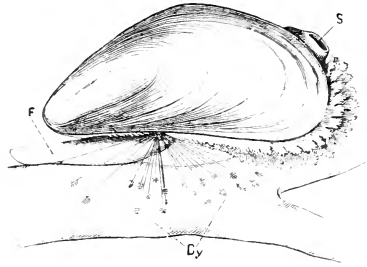

FIG. 595.—*Mytilus edulis*, attached by byssus (By.) to a piece of wood. *F*, foot; *S*, exhalant siphon. (From the *Cambridge Natural History*.)

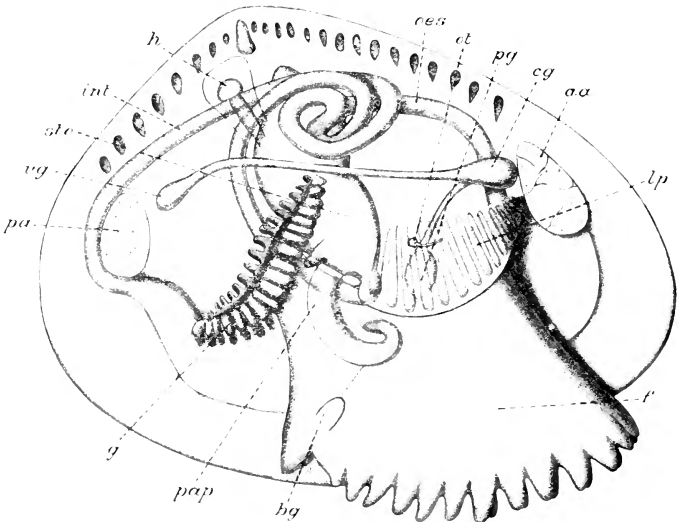

FIG. 596.—Adult specimen of *Nucula delphinodonta*, represented as seen from the right side. Reconstructed to show internal organs. Fully grown specimens are 4 mm. long. *aa*, anterior adductor muscle; *bg*, byssal gland; *cg*, cerebral ganglion; *f*, foot; *g*, gill; *h*, heart; *int*, intestine; *lp*, labial palp; *æs*, oesophagus; *st*, statocyst; *pa*, posterior adductor muscle; *pap*, palp-appendage; *pg*, pedal ganglion; *sto*, stomach; *vg*, visceral ganglion. (After Drew.)

Immediately posterior to the foot a **byssus-gland** is frequently found: it secretes a silky substance in the form of threads which serve to anchor the animal permanently or temporarily. It is by means of the byssus that the Sea-mussel (*Mytilus*) is attached to the rocks (Fig. 595, *By*): in *Pinna* the threads are fine enough to be woven in a fabric. In *Lima* the threads of the byssus are spun into a kind of nest in which the animals lie protected, and in species

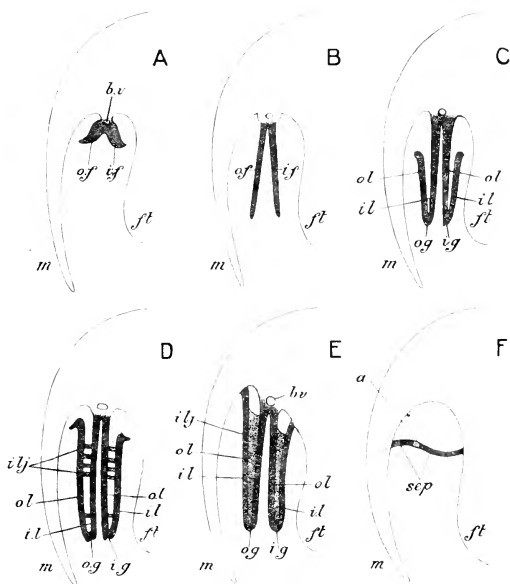

FIG. 597.—Half transverse sections of various Pelecypoda to show the chief kinds of gill. *A*, *Nucula*; *B*, *Amusium*; *C*, *Arca*; *D*, *Mytilus*; *E*, *Anodonta*; *F*, *Poromya*. *a*, aperture in branchial septum; *b. v.*, blood-vessel; *ft.*, foot; *i. f.*, inner row of filaments; *i. g.*, inner lamina; *i. l.*, inner lamella; *i. l. j.*, interlamellar junctions; *m.*, mantle; *o. f.*, outer row of filaments; *o. g.*, outer lamina; *o. l.*, outer lamella; *sep.*, branchial septum. (Modified from Korschelt and Heider, and Lang.)

of *Modiola* similar modifications of the byssus occur. In such forms as *Mytilus* the muscles which ordinarily serve to retract the foot are inserted mainly into the byssus: the latter being fixed, they serve to rotate the animal in various directions, or, in other words, act as *adjustors* and also as *retractors* of the byssus. It must be borne in mind that the definite byssus just described is not homologous with the provisional byssus of *Anodonta* (p. 675) which lies in front of the mouth.

The **gills** or **ctenidia** are two in number, right and left. Each consists of a horizontal axis bearing two rows of filaments, outer and inner, which are outgrowths from it. In the Protobranchia (e.g. *Nucula*) the filaments are short, compressed, and free from one another (Figs. 596, *g*, and 597, *A*). In *Amusium* (*B*) the gill-filaments are much elongated and thread-like instead of triangular.

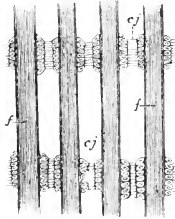

FIG. 598.—Four gill-filaments of *Mytilus*. c.j. ciliary junction; f. filaments. (From the Cambridge Natural History.)

In the common Ark-shell (*Arca*, *C*) a great change is seen. The gill-filaments are delicate and somewhat flattened threads, each bent upon itself into the form of an elongated **U**, and therefore consisting of a proximal or fixed limb and a distal or free limb. The flexure takes place in such a way that the free limb is external in the outer row of filaments, internal in the inner row. Adjacent filaments are loosely united by groups of large interlocking cilia (see

Fig. 598), placed at regular intervals, and in this way all the outer and all the inner limbs of the filaments are respectively joined together so as to convert each longitudinal row of **U**-shaped filaments into a double plate, fairly coherent unless the ciliary junctions are forcibly separated. In this way the single ctenidium of *Nucula* has given place to two plate-like simple laminae, each formed of an outer and an inner lamella: the inner lamella of the outer and the outer lamella of the inner laminae are united along their dorsal edges, the line of junction representing the axis of the ctenidium: the outer lamella of the outer and the inner lamella of the inner laminae are free dorsally.

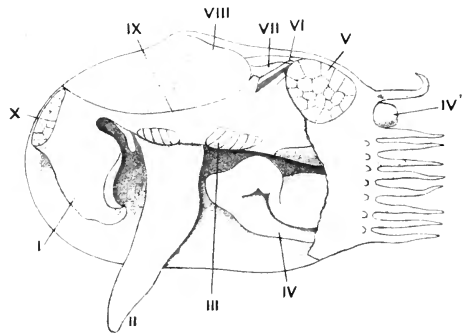

FIG. 599.—Dissection of *Poromya*. I, anterior palp; II, foot; III, lamella on branchial septum; IV, valve of branchial aperture; IV', anal siphon; V, posterior adductor; VI, posterior retractor of foot; VII, heart; VIII, ovary; IX, branchial septum; X, anterior adductor. (From Pelseener.)

In *Mytilus* (Fig. 597, *D*) the gill is strengthened by the development of delicate non-vascular bars or interlamellar junctions

between the two limbs of each filament. In *Lucina* these junctions are large and provided with blood-vessels; and vascular bars of tissue, the interfilamentar junctions, replace the ciliary junctions of the lower forms. Thus by a regular series of gradations the ctenidium is replaced by the complex double gill we are already familiar with in Anodonta. In all the higher forms the outer lamella of the outer lamina unites with the mantle and the inner lamella of the inner lamina with the visceral mass, while, posterior to the latter, the inner lamellæ of the right and left inner laminae unite with one another. The blood-vessels, which are confined to the filaments in the simpler types, occur also in the interfilamentar and interlamellar junctions in the more complex forms of gills. In the Septibranchia the gills are degenerate,

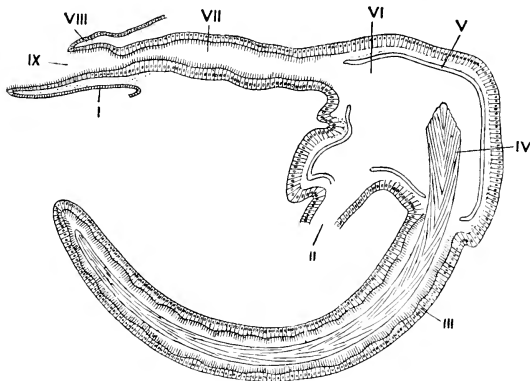

FIG. 600.—Sagittal section of part of enteric canal of *Donax*. I, lower lip; II, intestine; III, pyloric caecum; IV, crystalline style; V, cuticle; VI, stomach; VII, gullet; VIII, upper lip; IX, mouth. (From Pelseneer.)

being represented by a horizontal muscular partition or septum (Fig. 597, *F*, and Fig. 599, IX), which divides the inhalant and exhalant chambers from one another. Respiration in this case is performed entirely by the internal face of the mantle.

Digestive Organs.—The mouth is anterior; in forms with two adductor muscles it is always placed immediately behind the anterior adductor. It is usually bounded by two pairs of labial palps which sometimes attain a relatively immense size (Fig. 596); there is never any trace of jaws or other masticatory apparatus. The convolutions of the intestine are sometimes very complex. The crystalline style either lies freely in the stomach and anterior part of the intestine, or is contained in a caecal pouch of the stomach (Fig. 600), which may be prolonged into one of the lobes of the

mantle. The anterior end of the style, which projects into the stomach, appears to be slowly dissolved by the digestive juice, forming a sort of cement to enclose the hard particles of the food and prevent any harmful effect on the mucous membrane. It is possible also that the dissolved substance of the style may play the part of a digestive secretion, since it appears to contain a substance of the nature of a digestive ferment capable of acting upon starchy matters.

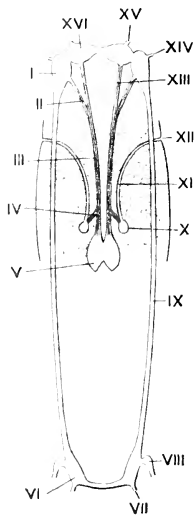

FIG. 601.—Nervous system and "auditory" organs of *Nucula*. I, pleural ganglion; II, pleuropedal connective; III, common connective from cerebral and pleural to pedal ganglia; IV, "auditory" nerve; V, pedal ganglion; VI, visceral ganglion; VII, posterior pallial nerve; VIII, osphradial ganglion; IX, visceral connective; X, statocyst; XI, canal of statocyst; XII, its external aperture; XIII, cerebro-pedal connective; XIV, anterior pallial nerve; XV, nerve to palps; XVI, cerebral ganglion. (From Pelseneer.)

The **excretory organs** or **kidneys** occur in their simplest form in the Proto-branchia, in which they have the form of cylindrical curved tubes, opening at one end into the pericardium and at the other on to the exterior; the whole organ is lined with glandular epithelium, and has no communication with its fellow of the opposite side. In the higher forms the organ becomes differentiated into a secreting portion or kidney, which is very spongy in texture, and opens into the pericardium, and a non-secreting portion or bladder, which opens externally. Frequently there is a communication between the right and left nephridia, and in some genera, such as the Oyster, the organs become extensively branched. Also taking a share in the process of excretion are the *pericardial glands*, or *Keber's organs*, glandular developments of the wall of the pericardium.

Circulatory Organs.—The heart is usually perforated by the rectum, but lies altogether above it in *Nucula* (Fig. 596, *h*) and some other genera; the ordinary arrangement seems to have been brought about by the heart becoming folded over the intestine and united below it. In the Oyster and some other forms the heart is below the rectum. In *Arca* the ventricle is divided into two by a constriction. Pores are often found on the surface of the foot, and it has been asserted that

through them the external water mixes with the blood; this, however, is certainly not the case: the blood-system is everywhere closed. The blood is red in some forms (*e.g.*, *Arca*) owing to haemoglobin in the corpuscles; in some cases it is of a bluish tint owing to the presence of haemocyanin.

The **nervous system** is found in its most primitive condition in *Nucula* (Fig. 601). Instead of the single cerebro-pleural ganglion of Anodonta there are, on each side, distinct cerebral (XVI) and pleural (I) ganglia, each united by a connective with the pedal.

The most characteristic **sense-organs** are the statocysts ("otocysts") and the osphradia. The *statocyst*—"auditory" or directive organ—is always placed in the foot, in close relation to

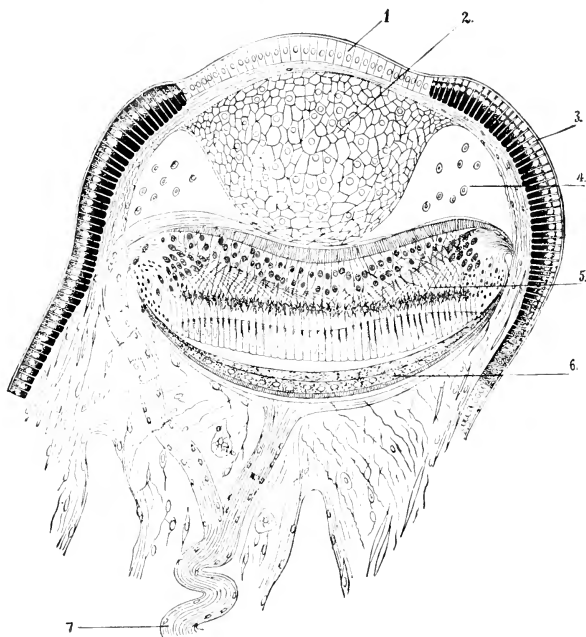

FIG. 602.—Vertical section of eye of **Pecten**. 1, cornea; 2, lens; 3, external epithelium; 4, blood-sinus; 5, retina; 6, pigimentary layer; 7, optic nerve. (From Korschelt and Heider.)

the pedal ganglion, sometimes embedded in the latter. The statocysts are developed as involutions of the ectoderm and retain their connection with the exterior in *Nucula* (Fig. 596, *ot*) and some others. In most cases they become closed sacs. The cavity is usually ciliated, but the cilia may be wanting. Each statocyst may contain a number of minute *statocones* or, more usually, a single, larger *statolith*. The nerves supplying the statocysts are given off not from the pedal ganglia, but from the cerebro-pedal

connectives, and their fibres are derived from the cerebro-pleural ganglia.

The *osphradia*—"olfactory" or water-testing organs—are patches of sensory epithelium with an accessory or osphradial ganglion situated in immediate relation with the visceral ganglia (Fig. 601, VIII), but connected by nerve-fibres with the cerebro-pleural ganglia. Patches of sensory epithelium, very similar to the osphradia, and called the *abdominal sense-organs*, occur one on each side of the anus in *Arca* and other forms devoid of siphons, and a similar organ has been described beside the retractor muscles of the siphons in several *Sinupalliata*.

In a few instances *eyes* are present, but never in what we are accustomed to consider as the normal position for such organs,

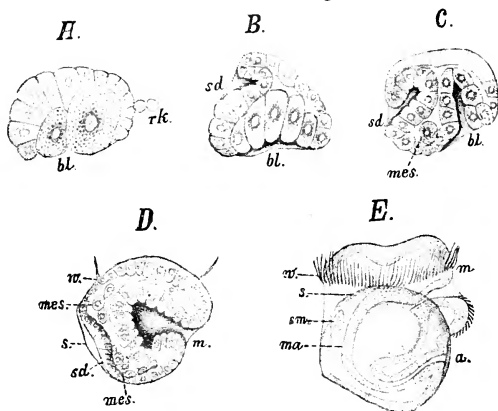

FIG. 603.—Five stages in the development of *Ostrea*. *a*, anus; *bl*, blastopore; *m*, mouth; *ma*, stomach; *mes*, mesoderm; *rk*, polar bodies; *s*, shell; *sd*, shell-gland; *sm*, anterior adductor; *w*, pre-oral circling of cilia. (From Korschelt and Heider.)

at the anterior or head-end of the body. They occur, in fact, in the only situation where they can be of any use, namely, along the edge of the mantle. The best-known form in which they occur is the common Scallop (*Pecten*), which has a single row (Fig. 585, VII) all round the mantle-border. Each has a cornea (Fig. 602, 1), a cellular (not cuticular) lens (2), a retina (5)—formed of cells, the inner ends of which are modified into visual rods, and an optic nerve (7), one branch of which spreads over the front of the retina and sends branches backwards to the visual rods. In this peculiarity, as well as in the cellular lens, the eye of *Pecten* is singularly like that of Vertebrates. The pallial eyes of Pelecypoda are probably to be looked upon as modified tentacles. The only cephalic eyes that occur in this class are a pair of small but well-

developed organs which occur in the bases of the most anterior filament of the inner lamina of the gill in *Mytilus* and some other genera.

Reproduction and Development.—Most Pelecypoda are dioecious, but several hermaphrodite forms are known. Some of these, such as some Oysters, are protandrous, the gonad producing first sperms and afterwards ova: in others part of the gonad serves as an ovary, part as a testis, the two opening into a common duct: in others again there is a distinct ovary and testis on each side opening by separate ducts. There are never any accessory organs of reproduction, such as spermatheca, penis, &c. Fertilisation frequently takes place in the water after the eggs are laid. Segmentation is total and follows the spiral type. One of the four megameres is very much larger than the other three. The gastrula is formed either by invagination or by epiboly. A shell-gland (Fig. 603, *sd.*) is formed as an invagination of the dorsal surface, a stomodæum (*m*) as an invagination of the ventral surface, and the larva of most forms, unlike that of Anodonta or Unio,

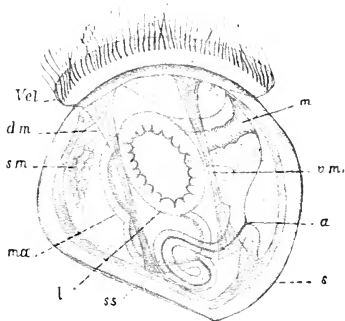

FIG. 604.—Veliger larva of *Ostrea*. *a.* anus; *dm.* dorsal longitudinal muscle; *l.* "liver"; *m.* mouth; *ma.* stomach; *s.* shell; *sm.* adductor muscle; *ss.* hinge of shell; *Vel.* velum; *vm.* ventral longitudinal muscle. (From Korschelt and Heider.)

the gastrula is formed either by invagination or by epiboly. A shell-gland (Fig. 603, *sd.*) is formed as an invagination of the dorsal surface, a stomodæum (*m*) as an invagination of the ventral surface, and the larva of most forms, unlike that of Anodonta or Unio,

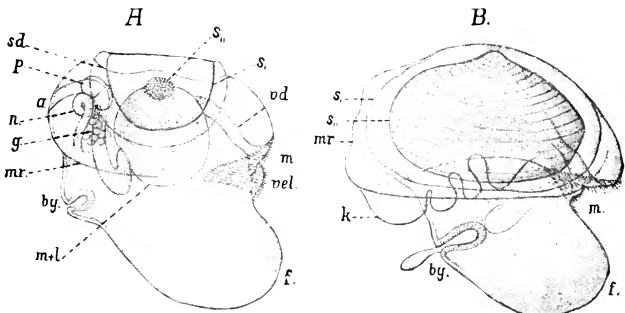

FIG. 605.—Two embryos of *Cyclas*. *a.* anus; *by.* byssus-gland; *f.* foot; *g.* gonad; *k.* gill; *m.* mouth; *m+l.* stomach and "liver"; *mr.* edge of mantle; *n.* kidney; *p.* pericardium; *s.* unpaired shell; *s'*, rudiment of paired shell; *sd.* shell-gland; *vd.* gullet; *vel.* velar area. (From Korschelt and Heider.)

passes into a stage in which it closely resembles the trochophore of Chætopods (Fig. 603), having a prototroch and an apical tuft in the middle of the prostomium. There is also an ectodermal thickening on the prostomium which becomes the cerebral ganglion, and a similar ventral thickening which gives rise to the pedal ganglion and corresponds with the rudiment of the ventral nerve-cord in Polychæta. The pelecypod trochophore is, however, distinguished from the corresponding stage in Worms by the presence of the shell-gland, which soon secretes an unpaired shell. The prostomial region grows out into a thickened retractile rim bearing the pre-oral circlet of cilia, and called the *velum* (Fig. 604, *Vel.*): the larva at this stage is distinguished as a *veliger*—a very characteristic mulluscan phase of development. The shell soon becomes bivalved and extends ventrally on each side, paired processes of the dorsal region of the body accompanying it and forming the mantle-lobes. A projection grows out from the ventral surface, between mouth and anus, and forms the foot (Fig. 605, *f.*), and on the sides of the body the gill-filaments (*k.*) arise as a row of fine processes, at first simple but afterwards becoming bent upon themselves so as to assume a V-shape. Eyes are often present in the larva at the base of the velum.

General Remarks.—Although none of the Pelecypoda are microscopic, they present a considerable range in size, from the minute *Nucula*, about 4 mm. long, to the Giant Clam (*Tridacna gigas*) of the Indian and Pacific islands, which is sometimes 60 cm. (two feet) in length and 500 pounds in weight.

Many pelecypod shells are white or dull brown in colour, but in several genera brilliant tints are the rule, the various species of Scallop (*Pecten*) being specially remarkable in this respect. The inner surface of the shell often exhibits beautiful iridescent tints, noticeably in the so-called Pearl-oyster (*Meleagrina*) and the Australian *Trigonia*. As far as is known, the colours are all what are called “non-significant,” *i.e.*, are of no physiological or ethological importance. In this connection the formation of *pearls* by some species must be mentioned: they are deposits of nacre formed usually round encysted parasitic worms, either between the mantle and shell or in the soft parts. They are produced, amongst other species, by the “Pearl-oyster” (*Meleagrina margaritifera*) and by the Pearl-mussel (*Unio margaritifera*). Some species, such as the common boring *Pholas*, are phosphorescent.

Most Pelecypoda are sluggish in habit, progressing only by slow contractions of the foot, and some are permanently fixed during adult life by the byssus, or are only able to change their position after throwing off the byssus, which becomes replaced by a new one. The Scallops, however, swim freely by clapping the valves together. The Cockles (*Cardium*), *Trigonia*, &c., jump by sudden movements of the foot, and the Razor-fish (*Solen*) jerks itself

forward by suddenly withdrawing its foot and thus ejecting water through the siphons. The only parasitic genus is *Entovalva*, found in the gullet of a Holothurian.

Pelecypoda are abundant both in fresh water and the sea; the marine forms are mainly littoral. None are pelagic or terrestrial. They are very abundant in the fossil condition, occurring in all formations from the Upper Cambrian upwards, and, owing to their gregarious habits, frequently forming extensive deposits or shell-beds. The oldest forms are all iso- or heteromyarian; the monomyarian types (Pseudolamellibranchia) appear first in the Carboniferous, and the Siphoniata not until the Triassic period. The modern genus *Arca* dates from the Upper Cambrian, and thus furnishes as striking an example of a "persistent type" as some of the Brachiopods.

There seems to be little doubt that the Protobranchia, and especially *Nucula*, exhibit the most primitive type of pelecypod

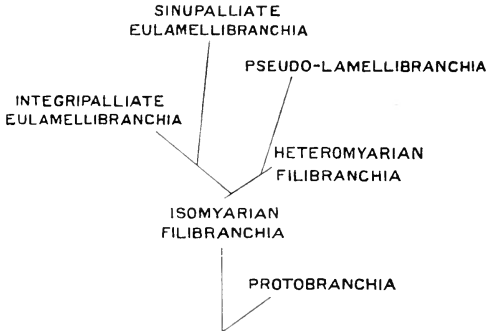

FIG. 606.—Diagram illustrating the mutual relationships of the Pelecypoda.

organisation, as indicated by the plume-like gills with separate filaments, the simple kidneys, and the distinct cerebral and pleural ganglia; absence of concrecence is always a mark of low or generalised organisation. The Filibranchia with imperfectly united gill-filaments come next, and are divisible into two groups—iso-myarian with equal-sized adductors, and heteromyarian with more or less atrophied anterior and proportionally enlarged posterior adductor; the latter group is to be looked upon as the more specialised, and leads to the Pseudolamellibranchia (monomyarian type) in which the anterior adductor disappears completely in the adult, while the posterior is immensely enlarged and assumes a central position. Similarly, the isomyarian Filibranchia lead to the Eulamellibranchia, which are equal-muscled, but have the gill-filaments united into a complete basket-work. In the Eulamelli-

branchia, lastly, there is a gradual series of stages from comparatively generalised forms with free mantle-lobes up to the highly specialised species with large siphons. That the Pseudolamellibranchia and the siphoniate Eulamellibranchia are to be looked upon as the highest members of the class is indicated not only by morphological evidence, but by their comparatively late appearance in time.

CLASS II.—AMPHINEURA.

The Amphineura are a class of marine Mollusca formerly grouped with the Gastropoda, but now recognised as sufficiently far removed from the latter to require separation as a distinct class. The commonest, as well as the most highly organised, of the Amphineura are the *Chitons*, a group of remarkably sluggish Limpet-like Molluscs with a shell composed of eight pieces. The other members of the class are lowly organised, comprising the simplest forms, all devoid of a shell, of the entire phylum.

1. DISTINCTIVE CHARACTERS AND CLASSIFICATION.

The Amphineura may be defined as bilaterally symmetrical, more or less elongated Mollusca, with terminal mouth and anus, either devoid of a shell, or possessing one which consists of eight median valves. The mantle contains numerous spicules of carbonate of lime, and is not divided into paired lateral lobes. The ctenidia are either absent, or there is a single pair, or they occur as a circlet round the anus, or as two lateral rows situated between the edge of the mantle and the side of the foot. A radula (*vide infra*) is sometimes present, sometimes absent. The nervous system consists of two pairs of nerve-cords, pedal and pallial, connected in front with a nerve-ring.

The class is divisible into two orders :

ORDER 1.—PLACOPHORA.

Amphineura with a broad foot, and with a shell which consists of eight transverse valves. There is a row of ctenidia on either side. This order includes the *Chitons*.

ORDER 2.—APLACOPHORA [SOLENOGASTRES].

Amphineura with an elongated body covered completely by the mantle, without shell, but with calcareous spicules. There is no foot, but generally a ventral longitudinal groove along which usually runs a low ciliated ridge. In some there is a posterior cavity (cloaca or mantle-cavity) containing a pair or a circlet of ctenidia.

This order includes *Neomenia*, *Proneomenia*, *Chatoderma*, and a number of other genera.

2. GENERAL ORGANISATION.

External Features.—The Aplacophora are distinguished by their worm-like body, sometimes elongated and narrow and capable of being coiled into a spiral, sometimes comparatively short and thick. In most instances there is little difference in external appearance between the anterior and posterior ends. In some species of *Chatoderma* (Fig. 607) alone is there in sexually mature specimens a “head,” separated off from the body by a constriction, as well as a posterior cloacal region which is similarly marked off. A shell is completely absent. The mantle covering the surface possesses a cuticle, in the substance or on the surface of which are spicules of calcified material. In many cases the dorsal surface is beset with uni- or multi-cellular epidermal papillæ. Along the middle of the ventral surface runs, in most instances, a groove, in some cases merely represented by a narrow strip from which the cuticle and spicules are absent. The ventral groove, when present, usually contains a slight longitudinal ridge, and this groove with its contained ridge is all that in these simple forms represents the foot, an organ so highly developed in other Molluscs. In *Chætoderma* it is entirely absent. With the ventral groove is connected in front an anterior ciliated groove, while behind it is in direct communication with the cavity of the cloaca.



FIG. 607.—*Chætoderma nitidulum*. a, anus; m, mouth. (From the Cambridge Natural History.)

In *Proneomenia* **ctenidia** are absent. In the remaining genera there is either a pair or a circlet of gills in the form of simple or complex folds situated in the cloaca—a cavity at the posterior end of the body into which the anus opens (Fig. 612).

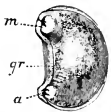

FIG. 608.—*Neomenia carinata*. a, anus; gr, ventral groove; m, mouth. (From the Cambridge Natural History.)

In *Chiton* (Figs. 609 and 610) the body is dorso-ventrally compressed, convex above, and presents below a broad flat foot (narrow in *Chitonellus*) which acts not only as an organ for effecting creeping movements, but also as a sucker for enabling the animal when at rest to adhere firmly, like a Limpet, to the surface of a rock.

The head region is not distinctly separated off, and is not provided with eyes or tentacles. The most remarkable external feature of *Chiton* is the presence on the dorsal surface of a calcareous shell (Figs. 609 and 611) made up of no fewer than eight transversely elongated pieces or valves, arranged in a longitudinal row, articulating together and partly overlapping one another. They are

sometimes partly, sometimes completely, covered over by the mantle. Each valve consists of two very distinct layers, a more

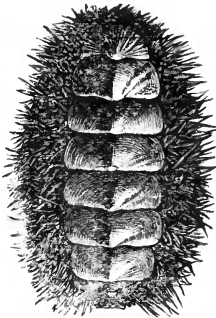

FIG. 609.—**Chiton spinosus**, dorsal view. (From the *Cambridge Natural History*.)

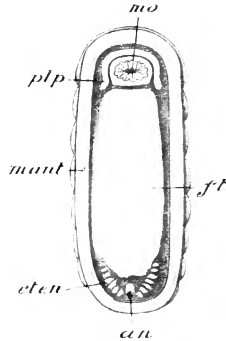

FIG. 610.—**Chiton**, ventral view. *an*, anus; *cten*, ctenidia; *ft*, foot; *mant*, mantle edge; *mo*, mouth; *plp*, palp. (After Pelseener.)

superficial and a deeper, the latter formed of compact calcareous substance, the former perforated by numerous vertical canals for the lodgment of the sense-organs to be presently referred to. External to the valves the dorsal integument (mantle) of Chiton and its allies is usually beset with a number of horny or calcified tubercles and spicules. The mantle develops only very slight lateral flaps, and under cover of these, in mere grooves which represent the mantle-cavities of other Molluscs, are a series of small ctenidia (Figs. 610 and 616, *cten.*) to the number of from fourteen to eighty. The mouth and anus are both median, situated at the anterior and posterior extremities respectively.

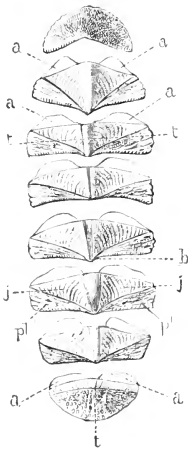

FIG. 611.—**Chiton**, valves of shell. (From the *Cambridge Natural History*.)

Alimentary System.—In the Aplacophora the mouth is usually a longitudinal, rarely (*Chatoderma*) a transverse, slit, situated ventrally near the anterior extremity. There is a buccal cavity, with a radula¹ in some cases (Fig. 612, *rad*), and in others a single chitinous tooth supporting smaller denticles: sometimes teeth are entirely absent. There are both salivary and buccal glands.

¹ For a description of the structure of this characteristic organ see the account of Triton (p. 708).

Very characteristic of the group as compared with other Molluscs is the presence of a straight intestine devoid of coils, and having connected with it a single dorsal cæcum and usually a double row of lateral cæca. In the Placophora the buccal cavity

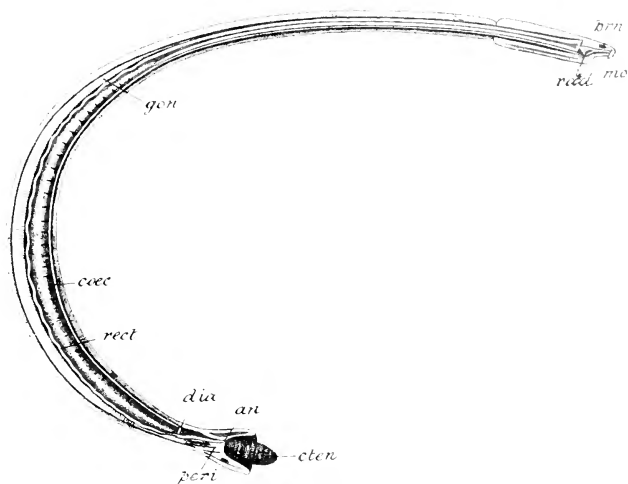

FIG. 612.—*Chaetoderma nitidulum*, longitudinal section. *an.* anus; *brn.* brain; *cæc.* glandular cæca of mesenteron; *cten.* ctenidium; *dia.* diaphragm separating off the posterior portion of the body; *gon.* gonad; *mo.* mouth; *peri.* pericardium and heart; *rad.* radula; *rect.* rectum. (After Simroth.)

always contains a well-developed odontophore and radula. The intestine is elongated and coiled. There are salivary glands and a large paired liver (Fig. 613, *liv.*).

Body-cavity.—In the Aplacophora the interstices between the

organs and the body-wall are filled with a form of connective-tissue with muscular fibres; a vertical diaphragm (Fig. 612, *dia.*) separates the posterior part of the body, containing the pericardium (*peri.*), from the rest. In the Placophora the cœlome (Fig. 613) is an exten-

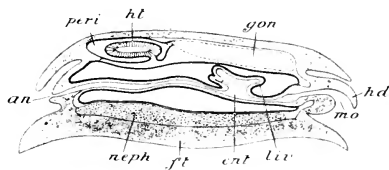

FIG. 613.—Diagrammatic longitudinal section of *Chiton*, specially intended to show the relations of the parts of the cœlome, which, except the genital parts, are bordered with a thick line. *an.* anus; *ent.* enteric cavity; *ft.* foot; *gon.* gonad; *hd.* head-lobes; *ht.* heart; *liv.* liver; *mo.* mouth; *neph.* kidney; *peri.* pericardial cavity. (From Simroth, after Haller.)

sive cavity, lined with a cœlomic epithelium, and divided into three completely separated parts—the pericardium, the genital cavity, and the general body-cavity.

Vascular System.—The vascular system of the Aplacophora is very rudimentary. There is a heart enclosed in a pericardium (Figs. 612 and 615, *peri*) and composed, when best developed, of an auricle and a ventricle.

In *Chiton* there is a well-developed heart (Fig. 613, *ht.*) consisting of a median ventricle and two lateral auricles. The pericardial cavity in which it lies is a space of considerable extent in the posterior region of the body, below the two last valves of the shell.

The **Nervous System** consists in the Aplacophora (Fig. 614, *A, B, C*) of four longitudinal nerve-cords—two *pedal* and two *pleural*. These are connected together by an œsophageal ring, thickened dorsally into a single or double *cerebral ganglion*; and in front of this is a second, more slender *stomatogastric* nerve-ring with small ganglia. The

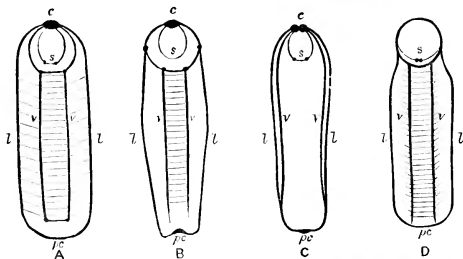

FIG. 614.—Nervous system of **Amphineura**. *A*, *Troneomenia*; *B*, *Neomenia*; *C*, *Chatoderma*; *D*, *Chiton*. *c*, cerebral ganglia; *l*, *l*, pleural cords; *pc*, posterior commissure; *s*, stomatogastric commissure or ring, with ganglia; *v*, *v*, pedal cords. (From the *Cambridge Natural History*, after Hubrecht.)

pedal cords (*v, v*) may present in front a pair of ganglionic thickenings connected by a commissure, and further back there may be a series of enlargements united by commissures. The pleural cords (*l, l*) are connected behind, above the rectum, by a commissure (*p, c*) which usually bears a median enlargement. Sometimes a union takes place posteriorly between the cords of the two pairs. There are no eyes, or statocysts, or tentacles. The dorsal epidermal papillæ are perhaps sensory. Some have a sensory frontal lobe and a sensory pit or elevation in the middle line of the dorsal surface near the posterior end.

In the Placophora (Fig. 614, *D*) there is an œsophageal nerve-ring consisting of a thicker dorsal *cerebral* portion not differentiated into ganglia, and a thinner ventral *buccal commissure*. The cerebral part sends off nerves to the labial palps, the lips, and the buccal apparatus. Two pairs of longitudinal nerve-cords, *pedal* and *pleural*, are given off posteriorly: the former, from which arise nerves to the foot, are joined by numerous commissures passing beneath the enteric canal; the latter, which send off nerves chiefly

to the mantle and the ctenidia, are united together by a supra-rectal commissure at the posterior end of the body. Near its origin each pleural cord gives off a slender *visceral commissure*, which unites with its fellow of the opposite side: two small ganglia lie in this visceral commissure near the middle line. The large cords contain nerve-cells throughout their length.

The conspicuous organs of special sense present on the head of Gastropods (*vide infra*), are absent in the Placophora, as in the Aplacophora. A pair of processes situated in front, at the sides of the mouth, have the character of labial palps. In the buccal cavity there are cup-shaped *gustatory organs* supplied with nerves from the cerebral commissure, and in front of the odontophore is a thickening of the epithelium—the *subradular organ*—containing nerve-endings. Remarkable *sensory organs*, the *micræsthetes* and the *megalæsthetes*, lie in the canals already mentioned as occurring in the superficial layer of the shell-valves. The *megalæsthetes* may take the form of eyes, with cornea, lens, pigment-layer, iris, and retina; in some cases the lens is absent.

Reproductive and Renal Organs.—In the Placophora the sexes are distinct: in the Aplacophora, with the exception of Chætoderma, they are united. In the Aplacophora (Fig. 615), with the exception of Chætoderma, the gonads are paired. The sexual products pass into the pericardial cavity and thence are carried to the exterior by a pair of ducts (cœlomoducts) opening into the cloaca. Renal organs are unknown in the Aplacophora.

In the Placophora (Fig. 616) there are two symmetrical kidneys, each opening internally into the pericardium by a ciliated funnel-like opening (*n. peri. ap*), and externally (*neph. ap*) between two of the posterior ctenidia some little distance in front of the anus. Each consists of a looped main tube, into which open numerous minute tubules which ramify among the viscera. The testis and ovary (*gon*) are similar in appearance, differing only in colour

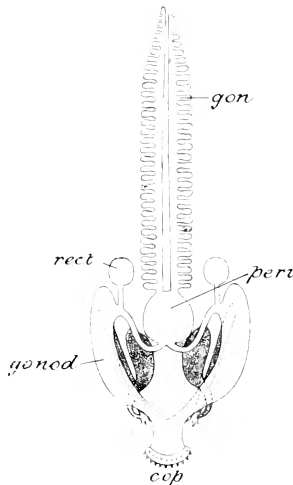

FIG. 615.—*Neomenia carinata*, reproductive organs. *cop*, copulatory organs; *gon*, gonads enclosed in extensions of the pericardial cavity; *gonod*, gonoducts; *peri*, pericardium; *rect*, receptaculum seminis. (From Simroth, after Wiren.)

when the products are mature. Each is an unpaired sac marked by a series of slight lateral constrictions. There are two gonoducts, each opening immediately in front of the corresponding nephridial duct.

Little is known of the **development** of the Aplacophora. The eggs undergo complete segmentation, and give rise to a gastrula by invagination. This develops into a form of trochophore with a ciliated ring, the *prototroch*. The larva is provided for a time with a row of seven calcareous plates on the dorsal surface.

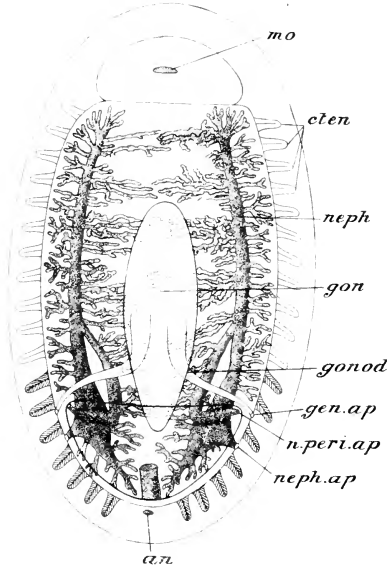

FIG. 616.—**Chiton**, nephridial and genital systems. *an.* anus; *cten.* ctenidia; *gen. ap.* genital aperture; *gon.* gonad; *gonod.* gonoduct; *mo.* mouth; *neph.* kidney; *neph. ap.* renal aperture; *n. peri. ap.* aperture from kidney to pericardium. (From Simroth, after Haller and Lang.)

The eggs of *Chiton* are fertilised in the mantle-cavity, where in one species they are retained until the embryos are fully developed. In other cases they are laid singly or in strings. The segmentation is complete, and corresponds very closely with that of the *Polychæta* (p. 440). The four megameres give off three quartettes of micromeres, which give rise to the ectoderm. The megameres give origin to the endoderm, and the mesoderm originates in a cell given off by the posterior megamere. **Micromeres and megameres** at first

arrange themselves in such a way as to form a somewhat flattened blastula, one side of which (vegetal pole) is composed of a comparatively small number of large endoderm cells. Then follows the invagination of the cells of the vegetal side and the resulting formation of a gastrula: this soon becomes elongated in the direction of the future long axis.

Two rings of cells surrounding the embryo develop cilia (Fig. 617, *cil.*), and owing to the double circlet thus formed an anterior and a posterior region are distinguishable in the larva. The

blastopore becomes shifted from its original posterior position forwards on the ventral surface until it comes to be situated just behind the circle of cilia; it undergoes elongation, and an invagination of ectoderm round its anterior end forms the mouth (*mo.*) and stomodæum. A ventral diverticulum of this forms the rudiment of the radular sac (*rd.*). By greater relative growth of the post-oral part the embryo assumes the form of a pear; and in this *trochophore* stage, with a pre-oral circle and a bunch of cilia in the middle of the apical area, it becomes free in the case of certain of the species, while in others it remains enclosed in the egg up to a later stage of development. As yet there is no anus, that aperture, with the proctodæum, being formed later by invagination. An apical plate is not present in the early larva; but the rudiments of the cerebral ganglia (*C, cer. g.*), which subsequently appear at the apical pole, probably represent it. Primitive nephridia, such

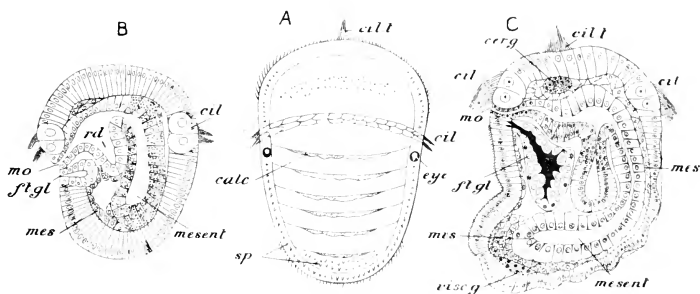

FIG. 617.—**Chiton**, development. *A*, general view of larva; *B*, section of early, and *C*, of later trochophore. *calc.* calcifications (rudiments of shell); *cer. g.* cerebral ganglion; *cil.* ciliary ring; *cil. t.* ciliary tuft at apical pole; *eye, eye*; *ft. gl.* foot-gland; *mes.* mesoderm; *mesent.* mesenteron; *mo.* mouth; *rd.* radular sac; *sp.* spines; *visc. g.* visceral ganglion. (From Korschelt and Heider. after Kowalewsky.)

as occur in Annulate and many Molluscan trochophores, are not present.

The post-oral region now becomes greatly elongated; the mesoderm increases greatly in extent, and forms two well-defined streaks, which are afterwards divided into parietal and visceral layers with a cœlomic space between them. The post-oral part of the embryo now presents an appearance resembling rudimentary segmentation. This is due to the development of a series of rudiments of the eight pieces of the shell (*A, calc.*), each of which is formed independently after the fashion of the entire shell of other Mollusca.

Ethology, Distribution, &c.—All the Amphineura are marine. The Placophora occur at all depths, though most abundant

on the shore between tidal limits. The Aplacophora, on the other hand, are rare in very shallow water, and absent altogether from the littoral zone: some have been found at considerable depths (down to 1,250 fathoms). Some of them burrow in mud, others live in association with various colonial Cœlenterates. The Placophora are all vegetable feeders, their food consisting of minute algæ and diatoms. When at rest, they adhere firmly to the surface of a rock or a block of coral by means of the sucker-like foot. When forcibly detached the animal curls itself up into a ball, and will only after a considerable time slowly extend itself again: all its movements are extremely sluggish.

The Aplacophora have no hard parts that would be recognisable in the fossil condition; but numerous fossil Placophora are known from the Silurian onwards. The valves of the Silurian genera differ from those of recent forms in the absence of the articulations.

CLASS III.—GASTROPODA.

The Gastropoda, including the Snails and Slugs, Limpets, Whelks, Periwinkles, Sea-hares, and the like, are Mollusca in which there is, as a rule, a shell composed of a single piece, and in which the mantle is not divided into two lateral folds as in the Pelecypoda. The body is inequilateral, owing to one-sided development. There is a well-developed ventral foot, usually with a broad, flat surface on which the animal creeps. A head-region bearing eyes and tentacles is distinguishable in front of the foot. The alimentary canal is characterised by the presence in the buccal region of a peculiar organ, the *odontophore*, present also in some of the Amphineura, bearing rows of minute chitinous teeth. Plume-like ctenidia are usually present. A metamorphosis occurs in the development, during which the young Gastropod passes successively through trochophore and veliger stages. The majority of the families of Gastropoda are marine, a few of these being pelagic; but some inhabit fresh water, and others are terrestrial.

I. EXAMPLE OF THE CLASS.—THE TRITON (*Triton rubicundus*).¹

Triton is a marine Gastropod living in shallow water, usually close inshore. The species to which the following description specially applies has a very wide range, from the English Channel to the South Pacific, and occurs as a fossil as far back as the Miocene. In most respects the English Whelk (*Buccinum undatum*) will be found to conform to the description.

The **shell** (Fig. 618) is a very hard and dense calcareous structure, presenting no trace of division into valves such as compose the

¹ Or *Charonia rubicunda*.

shell of the fresh-water Mussel, and lacking also its bilateral symmetry. It is in the form of an elongated hollow cone closely wound round a central axis. The apex of the cone is the organic apex of the shell, corresponding to the umbo of the fresh-water Mussel, and is the point from which the growth of the shell has proceeded: the base is represented by the wide oblique opening—the *mouth* or *peristome* of the shell. Starting from the apex along the internal cavity of the spirally-wound cone, in order to reach

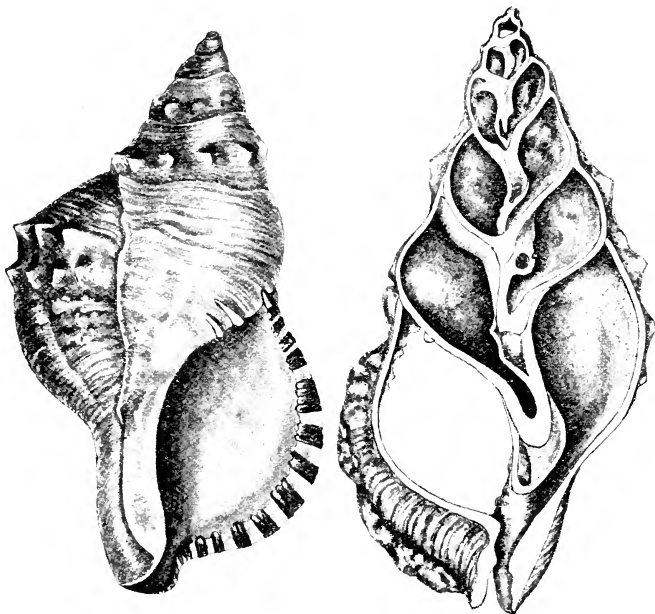

FIG. 618.—Shell of **Triton rubicundus**.
Natural size.

FIG. 619.—Longitudinal median section of the
shell of **Triton rubicundus**.

the mouth in an adult shell, we pass completely round the central axis five times—*i.e.* the spiral consists of five turns. In following the turns, the direction taken is to the right, that is to say, the spiral of the shell is a right-handed or *dextral* one. The axis (Fig. 619) is in the shape of a twisted shelly rod—the *columella*—containing a narrow lumen: it is formed by the close union of the axial portions of the wall of the spiral. The windings of the spiral are marked on the outer surface of the shell by a narrow

impressed spiral line or *suture*, parallel with which are numerous fine ridges and depressions—the *lines of growth*; the increase in size of the shell takes place in the direction of these lines, not at right angles to them as in the shell of the fresh-water Mussel, and the lines that more strictly correspond to the lines of growth of the latter are excessively fine striæ which run transversely to the stronger lines. At certain points, usually three in a full-grown shell, the spiral is interrupted by a transversely directed edge which appears to overlap the succeeding portion; this edge marks the position which the mouth of the shell has occupied during regularly recurring periods of arrest of growth, probably annual.

The mouth of the shell is bordered on the side turned away from the columella by a prominent rim or *outer lip* of the peristome; this is produced at the extremity farthest from the apex of the shell into a spout-like process—the *siphonal process*. The prominent edge of the peristome is in relation to the dorsal surface of the body of the animal; the opposite side has no prominent edge, but is rounded off to form a smooth *inner lip*; a couple of ridges on this inner lip towards the apical end aid the animal in drawing itself out after it has become retracted into the interior of the shell. The outer lip is in relation to the dorsal surface of the body of the animal, the inner lip in relation to the ventral surface; the siphonal process is for the lodgment of a spout-like process of the edge of the mantle—the *siphon*.



FIG. 620.—Operculum of *Triton rubicundus*.

When removed from the water, or disturbed in any other way, the animal becomes completely withdrawn into the interior of the shell, when the latter is observed to become closed by a plate—the *operculum* (Fig. 620)—which fits accurately across the passage some distance internal to the peristome. The operculum is an oval plate of chitinous material hardened by calcareous deposits; like the shell itself, it exhibits lines of growth marking what has been its edge at successive stages in the development of the shell.

The minute structure of the shell is in the main similar to that of the fresh-water Mussel (p. 666). Its outer surface is covered with a thin layer of uncalcified chitinous material, the *periostracum*, beneath which is a thick *prismatic* layer, and, lining the inner surface, a layer of *naere*.

External Features of Soft Parts.—The Triton is able to extend itself to a considerable degree beyond the mouth of the shell; but a portion of the body always remains concealed in the interior, even when the siphon has extended itself to its utmost, the body being, like that of the fresh-water Mussel (and of nearly all the Mollusca), organically connected with the shell. In Triton the connection is by means of a strong muscle—the *columellar*

muscle (Fig. 621, *col. m.*)—which extends from the concave right side of the animal to the columella, into which it is inserted; it is by means of this muscle that the anterior portion of the body, capable of being thrust out through the mouth of the shell, may again be withdrawn.

If the Triton be examined in the extended condition (Fig. 621) it will be found to present a distinct head, which bears dorsally

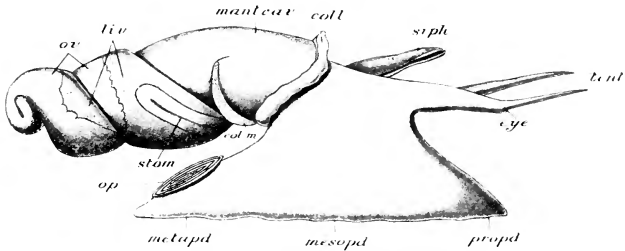

FIG. 621.—Lateral view of the body of a female specimen of *Triton rubicundus*, removed from the shell, moderately extended. *col. m.* columellar muscle; *coll.* collar of mantle; *eye*, eye; *liv.* liver; *mant. cav.* mantle-cavity; *meso.* mesopodium; *op.* operculum; *ov.* ovary; *prop.* propodium; *siph.* siphon; *stom.* stomach; *tent.* tentacles.

a pair of appendages—the *tentacles* (*tent.*)—of a sub-cylindrical shape, slightly compressed towards their bases, and narrowing somewhat towards their free extremities; these are capable of being extended and contracted, but not of being completely retracted. Each bears on its outer side, some little distance from the base, a prominent *eye*. At the anterior end of the head on its ventral aspect is the opening of the mouth. When the animal is feeding, an elongated cylindrical *introvert* (Fig. 622), comparable to that of *Sipunculus* (p. 484), is extended forwards, bearing the mouth at its anterior end; at other times the introvert is completely involuted within the head and anterior portion of the body. In the male, on the right-hand side of the body some little distance behind the head, is a long, narrow fleshy process, broader at the base than at the free end, and deeply grooved longitudinally; this is the *penis*. Running back from its base is a narrow groove with prominent lips—the *sperm-groove*, continuous with that of the penis; in the female these parts are not represented.



FIG. 622.—Diagram of the introvert of *Triton*, in longitudinal section, as it appears when almost completely extended. The black lines represent the wall of the alimentary canal; the cross-hatched part the wall of the introvert; the dotted line marks the position of the opening through which the introvert passes. *intro.* introvert; *mo.* mouth; *oes.* lumen of œsophagus.

Foot.—On the side of the body (ventral) which the animal applies to the surface of the ground when it extends from the

shell is a flat surface elongated in the antero-posterior direction. The wall of the body in this region is composed of a dense mass of muscular fibres: this is the principal part of the foot (*propodium* and *mesopodium* combined); the posterior portion (*metapodium*) is a thick process projecting behind this and bearing the operculum on its surface. The foot is highly contractile, and it is by means of contractions passing over it in a succession of undulations that the animal creeps along, dragging after it the rest of the body enclosed in the shell. In the middle line of its flat surface, nearer the anterior than the posterior end, is a slit-like aperture leading into a cavity lined with unicellular glands—the *pedal gland*.

When the remainder of the body has been removed from the shell, it is found to be twisted up into a coil—the **visceral spiral**, corresponding to the spire of the shell within which it was lodged. This is unsymmetrical, the axis of the spiral being directed not straight backwards, but backwards, upwards, and to the right. The external asymmetry of the body is not strongly marked in the part which is capable of being protruded from the shell, but is still recognisable; and an examination of the internal organs shows a marked excess of development on the left-hand side, *i.e.* the side which corresponds with the longer outer side of the spiral of the shell. The surface of the part of the animal which is capable of being pushed out from the shell is covered with a thick integument, which is darkly pigmented except on the lower surface of the foot. Over the visceral spiral the **mantle** forms a thin, delicate, colourless layer. Anteriorly the mantle becomes thickened and pigmented, and at the posterior limit of the protrusible part gives rise to a thickened ridge, the *collar* (Fig. 621, *coll.*), forming a semicircle over the dorsal and lateral regions. In the middle the collar is not in close contact with the body, but leaves a large cleft leading into a very wide space extending backwards for a considerable distance. This space, which is formed by an infolding of the mantle, is termed the *mantle-* or *pallial-cavity*. In it are to be found the ctenidium, the osphradium, and the anal, excretory, and reproductive apertures. The wall of the cavity is much folded and plaited, and contains a quantity of glandular tissue, the plaits being most numerous on the right-hand side in front of the anus.

The **ctenidium** or gill (Fig. 623, *cten.*) is closely applied to the wall of the mantle-cavity to the left of the middle. It consists of a main stem, with which are connected a row of delicate flexible laminae set at right angles to it: these are broadest in the middle, becoming smaller towards the ends.

The **osphradium** (*osph.*) lies close to the ctenidium on its outer side, in the natural position of the parts (reversed in the figure owing to the reflection of the wall of the mantle-cavity). It

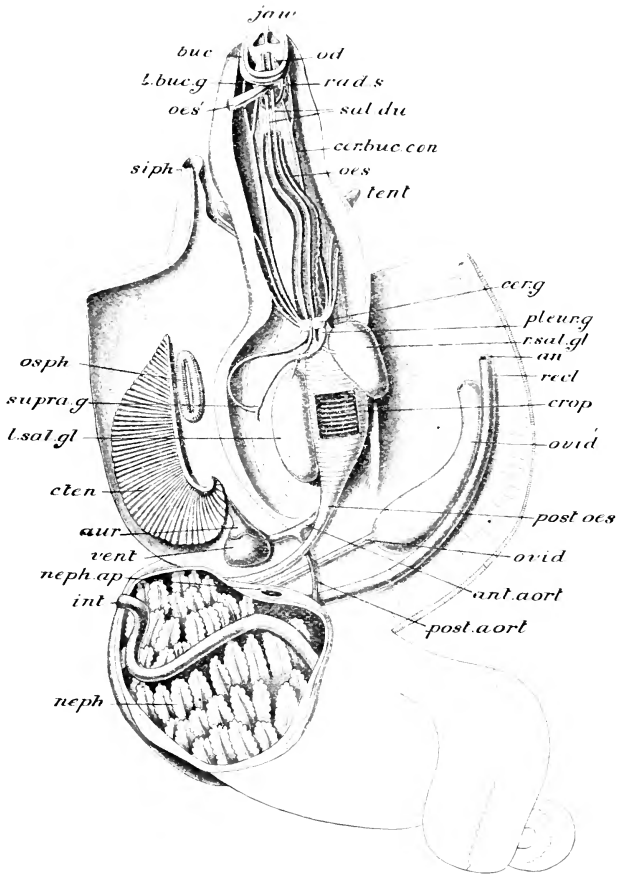

FIG. 623.—*Triton rubicundus*. Dissection of the internal organs of a female, viewed from the dorsal side. The roof of the mantle-cavity has been divided by a longitudinal incision and the flaps laid out, that on the left bearing the ctenidium and osphradium, and that on the right the rectum and terminal part of the oviduct. The muscular dorsal wall of the body and the introvert have been divided so as to bring into view the anterior part of the alimentary canal and a portion of the nervous system. The buccal cavity has been tilted up and opened so as to show the odontophore, and the oesophagus has been cut through near the anterior end. A portion of the ventral wall of the crop has been removed so as to bring the internal folds into view, and the interior of the nephridium with the contained portion of the intestine has been exposed. *Note*. The complete course of the intestine through the nephridium is not shown; the stomach is not seen, being hidden by the nephridium, and the ovary is not represented. *an*, anus; *ant. aort.*, anterior aorta; *aur*, auricle; *buc*, buccal cavity; *cer. buc. con*, cerebro-buccal connective; *cer. g.*, cerebral ganglia; *crop*, crop; *cten*, ctenidium; *int*, intestine; *jaw*, jaw; *l. buc. g.*, left buccal gland; *l. sal. gl.*, left salivary gland; *neph*, kidney; *neph. ap.*, renal aperture; *od*, odontophore; *oes*, oesophagus; *oes'*, anterior end of same, cut and turned aside; *osph*, osphradium; *ovid*, oviduct; *ovi'*, terminal thick-walled portion of oviduct; *pleur. g.*, pleural ganglion; *post. aort.*, posterior aorta; *post. oes.*, posterior oesophagus; *rad. s.*, radula sac; *rect*, rectum; *r. sal. gl.*, right salivary gland; *sal. du.*, salivary duct; *siph*, siphon; *supra. g.*, supra-oesophageal visceral ganglion; *tent*, tentacle; *vent*, ventricle.

presents a central axis, connected at right angles with which are two rows of close-set delicate lamellæ. Like the ctenidium, it is closely applied to the wall of the mantle-cavity throughout its length. The laminae of the osphradium are supplied with nerves which ramify over them, and its function seems to be to ascertain the condition of the water that enters the mantle-cavity.

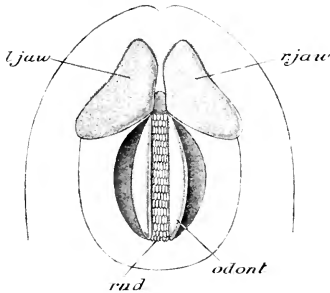

FIG. 624.—*Triton rubicundus*. Interior of the buccal mass, from above, magnified. *l.jaw*, left jaw; *odont*, lateral surface of odontophore; *rad*, radula; *r.jaw*, right jaw.

and on examination under the microscope are found to be composed of numerous rows of minute bodies, the *denticles*; the anterior edge is minutely denticulated. From the floor of the cavity rises an elevation, the *odontophore* (Fig. 623, *od.*, Fig. 624, *odont.*), which is somewhat elongated in the direction of the long axis of the body and compressed laterally. Over the summit of the odontophore runs longitudinally a narrow strap-like body, the *radula* or *lingual ribbon* (Figs. 624 and 625, *rad.*), beset with numerous minute horny teeth arranged in transverse rows. Posteriorly this toothed ribbon passes into a narrow curved pouch

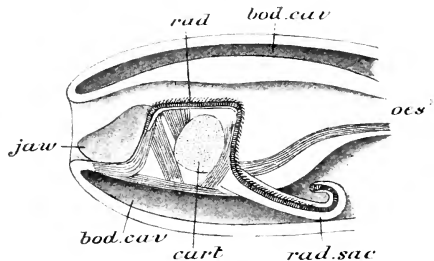

FIG. 625.—*Triton rubicundus*. Diagrammatic longitudinal vertical section of buccal cavity. *bod.cav*, body-cavity; *cart*, cartilage of odontophore; *jaw*, right jaw; *oes*, oesophagus; *rad*, radula; *rad.sac*, radula sac.

—the *radular sac* (Fig. 623, *rad. s.*, Fig. 625, *rad. sac.*)—extending backwards from the posterior and lower aspect of the buccal cavity. Anteriorly it does not extend beyond the odontophore-prominence. The latter contains cartilages (Fig. 625, *cart.*)

erving for the support of the whole apparatus, and is capable of being extruded, with the radula which it bears, through the opening of the mouth, by the contraction of sets of protractor muscular fibres. Muscles inserted into the odontophore also effect the movements of the radula by means of which it produces a rasping effect on the food, and probably the radula itself is capable of a certain degree of to-and-fro movement on the membrane (*sub-radular membrane*) which lies beneath it. The entire buccal cavity is capable of being drawn forwards towards the mouth opening, or backwards into the introvert, by the contraction of strands of muscular fibres passing from its wall to the wall of the body.

From the buccal cavity runs backwards a long narrow tube with sacculated walls—the *œsophagus* (Figs. 623 and 625, *œs.*). Posteriorly this opens into a large ovoid sac—the *crop* (Fig. 623, *crop*). The outer surface of the crop appears marked with numerous close-set fine lines, transverse or oblique in direction; and, when the cavity of the organ is opened, it is found that these correspond to numerous delicate folds which extend far inwards, and almost completely block up the lumen. On either side of the crop is a large gland—the *salivary gland* (Fig. 623, *l. sal. gl.*, Fig. 627, *r. sal. gl.*)—partly composed of a compact glandular substance, partly of spongy tissue in which the secretion collects. The two salivary glands are unlike in size and shape, that on the left-hand side being much longer than that on the right. Each has a narrow duct (*sal. du.*) which runs forwards and inwards to the dorsal aspect of the œsophagus, where the two come into close apposition, becoming embedded in the wall of the œsophagus, along which they run forwards to open into the buccal cavity.

From the crop leads backwards and to the left a narrow cylindrical tube—the *posterior œsophagus*. On this follows a *stomach* (Fig. 621, *stom.*) which is in the form of a U-shaped tube partly embedded in the substance of the *digestive gland* or “*liver*,” the *hepatic ducts* from which open into it. The tubular stomach is followed by a somewhat narrower tube—the *intestine* (Fig. 623, *int.*). This enters the cavity of the nephridium, round the interior of which it bends; and, leaving it at its right-hand side, runs forwards in a straight course as the *rectum* (*rect.*), embedded in the glandular wall of the mantle-cavity, to near the anterior end, where it terminates in a short, freely projecting, spout-like portion, with the anus (*an.*) at its extremity.

The *digestive gland* or “*liver*” forms a mass of reddish-brown glandular follicles which compose the greater part of the bulk of the visceral coil.

Vascular System.—Close to the base of the ctenidium, behind it and a little to the right, is the *heart*, lodged, like that of the fresh-water Mussel, in a cavity, the *pericardium*, lined by a trans-

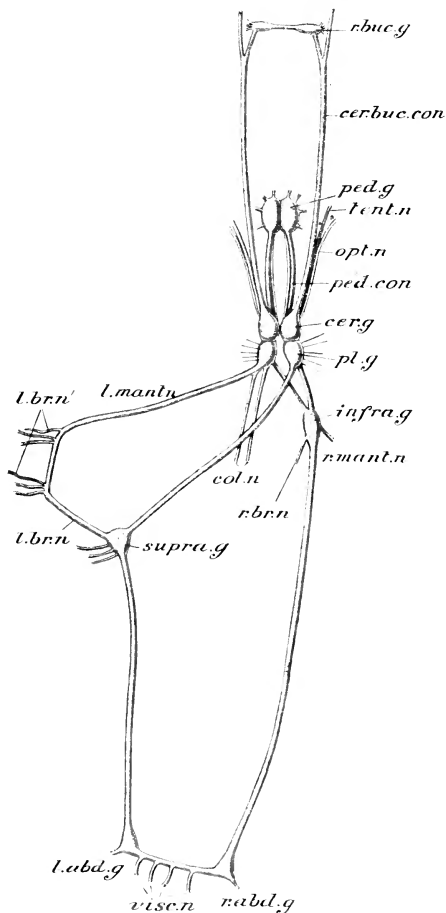

FIG. 626.—*Triton rubicundus*. Nervous system, from the dorsalside. *cer. buc. con.*, cerebro-buccal connective; *cer. g.*, cerebral ganglion; *col. n.*, nerves to the columellar muscle; *infra. g.*, infra-oesophageal visceral ganglion; *l. abd. g.*, left abdominal ganglion; *l. br. n.*, left branchial nerve; *l. br. n'*, nerves to branchia and osphradium; *l. mant. n.*, left mantle-nerve; *opt. n.*, optic nerve; *ped. con.*, cerebro-pedal and pleuro-pedal connectives; *ped. g.*, pedal ganglia; *pl. g.*, pleural ganglion; *r. abd. g.*, right abdominal ganglion; *r. br. n.*, right branchial nerve; *r. buc. gang.*, right buccal ganglion; *r. mant. n.*, right mantle-nerve; *supra. g.*, supra-intestinal visceral ganglion; *tent. n.*, nerve to tentacle; *visc. n.*, visceral nerve-branches.

parent membrane—the *pericardial membrane*. The heart consists of two chambers, an auricle (Fig. 623, *aur.*) and a ventricle. The auricle, which is the smaller of the two, is situated somewhat in front of the ventricle, close to the ctenidium, from the main central vessel of which it receives the blood. The ventricle (*vent.*) is of somewhat pyramidal shape, but with the edges rounded off. Its wall is extremely thick and muscular. Passing out from the ventricle towards the right is a thick artery, which soon divides into two, one running forwards, the other backwards—the *anterior (ant. aort.)* and *posterior (post. aort.) aorta*. The former is a very large trunk which runs forwards below the posterior oesophagus, crop, and

anterior œsophagus, giving off branches to the region of the head as it goes. The posterior aorta, narrower than the anterior, passes into the visceral spiral, where it breaks up into branches for the supply of the various parts. The blood-system consists in large measure of sinuses, as in the fresh-water Mussel, and the general course of the circulation is similar to what has already been described in that Mollusc (p. 672).

Excretory System.—There is only one *kidney* (*neph.*), a large organ situated dorsally, behind the pericardium. It is a sac with thick, glandular, and highly vascular walls, the inner surface of which is thrown into numerous complex folds. In front it communicates directly by a large aperture (*neph. ap.*) with the mantle-cavity, and by a narrower passage with the pericardium.

The **nervous system** (Figs. 626 and 627) is more highly elaborated than in the fresh-water Mussel. Two pairs of nerve-

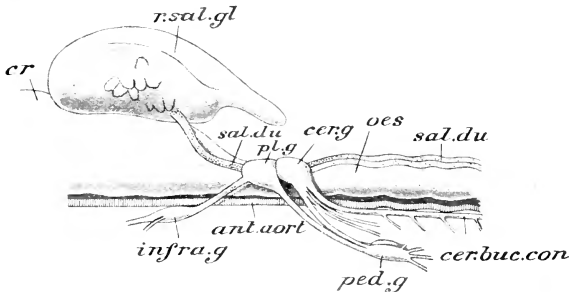

FIG. 627.—*Triton rubicundus*. Lateral view of nerve-ganglia and related parts. Letters as in Fig. 626; in addition—*ant. aort.*, anterior aorta; *cr.*, crop; *oes.*, œsophagus; *sal. du.*, salivary duct; *r. sal. gl.*, right salivary gland.

ganglia—the *cerebral* (*cer. g.*) and the *pleural* (*pl. g.*)—lie close together over the posterior part of the œsophagus, just where it passes into the crop. The right and left cerebral ganglia are fused together in the middle line, though separated by a constriction, and the ganglia of the two pairs are placed very close together, though quite distinct. From each cerebral ganglion there passes forwards a stout *cerebro-buccal connective* (*cer. buc. con.*) to a buccal ganglion (*r. buc. g.*) situated on the posterior surface of the buccal chamber. Also given off anteriorly from the cerebral ganglia are *optic nerves* (*opt. n.*) to the eye and tentacular nerves (*tent. n.*) to the tentacles. From each cerebral ganglion passes downwards and forwards a stout *cerebro-pedal connective*, and from each pleural ganglion a *pleuro-pedal connective*, to a large pair of closely-united *pedal ganglia* (Figs. 626 and 627, *ped. g.*) embedded in the upper layers of the muscles of the foot, to which they give off numerous nerves. The right pleural ganglion gives off behind a

supra-intestinal visceral connective, which bends across to the left, over the œsophagus, and, some distance to the left of the alimentary canal, expands into a triangular *supra-intestinal visceral ganglion* (*supra. g.*), situated below the superficial layer of muscular fibres. The left pleural ganglion gives off an *infra-intestinal visceral connective*, which passes obliquely backwards and to the right, below the alimentary canal, to a ganglion situated a little to the right of the middle line—the *infra-intestinal visceral ganglion* (*infra. g.*). The supra-intestinal ganglion gives off a nerve which runs towards the osphradium and ctenidium, which it supplies with branch nerves, and unites with a stout *mantle-nerve* (*l. mant. n.*), which is given off from the left pleural ganglion. The right pleural also gives off a stout connecting nerve to the infra-intestinal ganglion. From the supra- and infra-intestinal ganglia the left and right

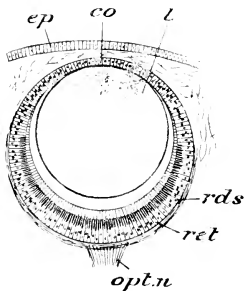

FIG. 628.—**Triton.** Section of the eye. *co.* cornea; *ep.* epidermis; *l.* lens; *opt.n.* optic nerve; *rds.* layer of rods (the line is not continued far enough inwards); *ret.* retina.

visceral connectives are continued backwards and unite behind in the neighbourhood of the stomach; each ends in a triangular *abdominal ganglion* (*l. abd. g.*; *abd. r. g.*), and these are joined by a transverse commissure, from which a number of visceral nerves (*visc. n.*) are given off. A remarkable torsion of the nerve connectives is here to be observed, the two visceral connectives becoming twisted into the form of the figure 8.

The organs of special sense of Triton, in addition to the *tentacles* and the *osphradium*, which have been already referred to, are the *eyes* and the *statocysts*. The eye (Fig. 628) is a rounded invagination of the epidermis with an inner wall or *retina* (*ret.*) composed of pigmented and sensory cells. The latter (*retinophores*) are elongated cells narrowed at their central free ends, and produced at the opposite extremity to become continuous with nerve-fibres of the optic nerve. The former (*retinula*) have their free extremities much enlarged, and surround the slender ends of the retinophores. A layer of short rods (*rds.*) lies within the retina proper. The outer wall is thin, and, with the overlying epidermis, forms a transparent *cornea*. In the interior of the eye is a clear rounded *lens* (*l.*) of dense cuticular matter secreted by the cells of the retina; this is surrounded by a less dense *vitreous* body.

The **sexes** are distinct. There is a single gonad—*ovary* or *testis* as the case may be—lodged in the visceral spiral. The *spermiduct* is a white tube, thickish and much convoluted where it leaves

the testis, narrower and straight distally; it opens in front in the mantle-cavity into the proximal end of the sperm-groove, which, as already mentioned, runs forwards along the right side and becomes continuous with the groove traversing the penis. The oviduct (Fig. 623, *ovid.*) is proximally a very delicate tube with colourless, transparent walls. This runs forwards to the right side of the mantle-cavity, where it assumes the character of a stout tube (*ovid'*) with thickened glandular walls, which passes forwards close to and parallel with the rectum, and opens on the exterior near the anus.

2. DISTINCTIVE CHARACTERS AND CLASSIFICATION.

The Gastropoda are unsymmetrical Mollusca, with a mantle which is not divided into two lateral portions, and usually a shell, which does not consist of two lateral valves, but of a single, unsymmetrical, usually spirally coiled valve, enclosing a visceral mass of corresponding form. There are, typically, two plume-like ctenidia enclosed in a mantle-cavity, but there may be only one; and in air-breathing forms ctenidia are not developed, respiration taking place through the wall of the mantle-cavity itself. A distinct head bearing eyes and tentacles is present in the majority. The foot is situated behind the head, and usually has an extensive flattened ventral surface. The buccal cavity contains an odontophore. The kidney is usually single. The nervous system contains distinct cerebral and pleural, besides pedal, visceral, abdominal, and buccal ganglia. The sexes are sometimes separate, sometimes united. The larva passes through trochophore and veliger stages.

Sub-Class I.—Streptoneura.

Gastropoda in which the visceral connectives are in most cases twisted into a figure of 8, and in which the sexes are distinct.

ORDER I.—ASPIDOBRANCHIA.

Streptoneura with the nervous system but little concentrated: the pedal ganglia are produced into long cords with the anterior ends of which the pleural ganglia are fused; the cerebral ganglia wide apart; the osphradium little developed. There is nearly always a single ctenidium or a pair, plume-like and free distally. The auricles and the kidneys are usually paired.

Sub-Order 1.—Docoglossa.

Aspidobranchia in which the pleural ganglia are not connected with the opposite visceral connective. The eye is in the form of an open pit, without lens. There are two osphradia, a single jaw, and no operculum. The visceral mass is conical.

This section includes the Limpets (*Patellida*).

Sub-Order 2.—Rhipidoglossa.

Aspidobranchia in which each pleural ganglion is connected with the opposite visceral connective. The eye is a closed sac and contains a lens. There are nearly always a single osphradium, a pair of jaws, and two auricles.

This sub-order includes the Ear-shells (*Haliotida*), *Trochus*, *Turbo*, and others.

ORDER 2.—PECTINIBRANCHIA.

Streptoneura with a somewhat concentrated nervous system. There is a single osphradium which is often pectinate. The primarily right ctenidium is alone developed. The heart has a single auricle. The ctenidium consists of a stem with a single row of lamellæ, attached throughout its length to the wall of the mantle-cavity.

Sub-Order 1.—Platypoda.

Pectinibranchia with the foot flattened ventrally, at least in front. Jaws are nearly always present.

This sub-order includes the Cowries, the Vermetes, the Tritons, the Whelks, the Cones, and a number of other groups.

Sub-Order 2.—Heteropoda.

Pelagic Pectinibranchia with the foot laterally compressed and bearing, at least in the male, a ventral sucker. The visceral sac and mantle form only a small part of the mass of the body. Jaws are absent.

Sub-Class II.—Euthyneura.

Gastropoda in which the visceral connectives are not twisted into a figure of 8, and in which the sexes are united.

ORDER 1.—OPISTHOBRANCHIA.

Marine Euthyneura with aquatic respiration, the auricle of the heart usually posterior to the ventricle. The mantle-cavity, when present, opens by a wide aperture.

Sub-Order 1.—Tectibranchia.

Opisthobranchs provided in nearly all cases with a mantle and a shell, nearly always with a true ctenidium, and an osphradium.

This section comprises the *Aplysida*, or Sea-hares, and several other families, including certain pelagic Gastropoda, some shell-bearing, some shell-less, formerly regarded as constituting a distinct class—the *Pteropoda*.

Sub-Order 2.—Nudibranchia.

Opisthobranchs which are devoid of a shell in the adult condition, and have no true ctenidia or osphradia, respiration being carried on by means of secondary branchiæ usually arranged in a circlet around the anus, or in rows on the dorsal surface, or laterally under the edge of the mantle.

This sub-order includes *Doris*, *Eolis*, *Tethys*, and other shell-less forms.

ORDER 2.—PULMONATA.

Euthyneura devoid of ctenidia, respiration being carried on through the walls of the mantle-cavity, which has a narrow contractile aperture.

This sub-order includes the Land-Snails and Slugs.

Systematic Position of the Example.

Triton rubicundus is one of several species of the genus *Triton*, which is the only member of the family *Tritonidæ* belonging to the sub-order *Platypoda*. The family *Tritonidæ* differs from the other families of the sub-order in the possession of a proboscis, of a well-developed, but not greatly elongated, siphon, and of a short foot.

3. GENERAL ORGANISATION.

External Features, Symmetry, &c.—Few Gastropods make an approach towards even superficial symmetry, and in cases in which there is a near approximation towards such a state of things, it seems clear, from the results of the study of development and of a comparison with allied forms, that the symmetry presented is not primitive, but has been secondarily acquired—such symmetrical forms having been derived from unsymmetrical ancestors.

The departure from symmetry is most marked in the majority of the Streptoneura. It may be said to be due to the development of a protective shell composed of one piece and extensive enough to be capable of enclosing all the soft parts; and to the extension of the foot on the ventral side as an elongated muscular creeping organ. The development of the shell rendered necessary an arrangement of the parts whereby the mantle-cavity with the anus, the ctenidia, and the excretory apertures should come to be situated in the neighbourhood of the opening of the shell, *i.e.*, towards the head-end of the animal. The mantle-cavity and associated parts (*pallial complex*, as the whole is termed) had, therefore, to be shifted forward from its primitive posterior position, and this was probably effected by arrest or retardation of growth on one side and active extension on the other. In the majority of cases it is the right side the growth of which becomes

retarded, and, in consequence, it is on the right side that the pallial complex comes to travel forwards. The effect is as if, the head retaining its symmetry, the parts between it and the anus had undergone a process of rotation or *torsion* through about 180° around a vertical axis passing in a dorso-ventral direction—the

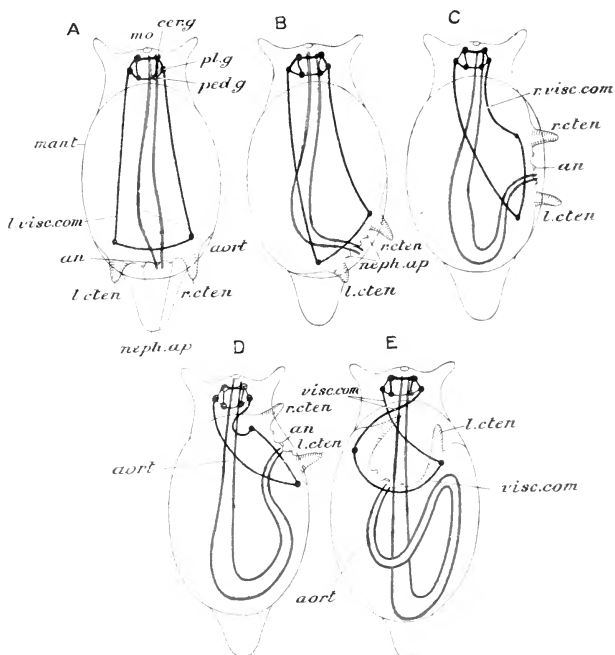

FIG. 629.—Diagrammatic representation of the displacement of the mantle-cavity and associated parts in the **Gastropoda**. Enteric canal blue, blood-system red. A represents a nearly symmetrical arrangement; in B, C, D are represented successive stages of displacement of the mantle-cavity to the right and forwards; in E the anus and (primarily) right ctenidium have passed the middle line. an, anus; aort, aorta; cer. g, cerebral ganglion; l. cten, left ctenidium; l. visc. com, left visceral connective; mant, mantle; mo, mouth; neph. ap, renal apertures; ped. g, pedal ganglion; pl. g, pleural ganglion; r. cten, right ctenidium; r. visc. com, right visceral connective; visc. com, visceral connectives. (After Korschelt and Heider.)

direction of torsion being opposite that of the movement of the hands of a watch (Fig. 629).

With regard to the spiral form assumed by the shell in all highly developed Gastropods, it can only be pointed out here that, given the necessity for complete protection, compactness, and a provision for continuous growth, the spirally-coiled cone is the form of shell

best adapted to all the conditions. A straight cone, however directed, would be a great impediment to active progression, and the coiling in a compact spiral would seem to be the line of development best adapted to secure concentration and strength.

The rotation around a dorso-ventral axis is not the only form of torsion leading to the markedly unsymmetrical disposition of parts observable in most Gastropoda. There is also a process of torsion around a horizontal axis which, the head and foot being regarded as fixed, results in the visceral mass enclosed in the spiral shell coming to occupy a more or less dorsal position with the apex directed backwards and to the right.

The shifting of the pallial complex in many Streptoneura proceeds so far that the complex completely or partially passes across the middle line, and the anus comes to be situated to the left of the mouth. The displacement of the pallial complex involves two important series of changes in the internal organs, in addition to the suppression of certain structures to be referred to presently. In the first place there is necessarily involved a throwing of the enteric canal into a loop (Fig. 629), and in the second place the long pleuro-visceral connectives (*visc. com.*) become twisted in such a way as to assume the form of the figure 8—the right connective becoming *supra-intestinal* and the left *infra-intestinal*.

Universally accompanying the process of forward displacement of the pallial complex, except in *Haliotis* and *Fissurella* and allied Rhipidoglossa, occurs the reduction of its paired parts. Thus in all the more highly developed Streptoneura the primitively right (topographically left) ctenidium alone persists, and one of the two kidneys is alone fully developed and functional.

In the Euthyneura there are distinguishable various stages in a process of *detorsion* by which the torsion tends to be reversed and the pallial complex carried back towards the posterior end along the right side. The pleuro-visceral connectives lose their twisted arrangement in nearly all such cases; but there is the same reduction of the paired parts of the pallial complex as in the Streptoneura.

The **shell** in the adult limpets (*Patella* and allied genera) is in the form of a short cone. In most of the Gastropoda it is in the shape of a spiral with the turns usually in close contact with one another, the inner walls of the turns coalescing to form an axial, hollow or solid column—the *columella*. The portion of the shell projecting inwards between the turns of the spiral sometimes becomes absorbed. In certain cases, on the other hand, the cavity of the apical portion of the spiral may be cut off from the cavity of the rest of the shell by the formation of a transverse partition, the animal then becoming restricted to the basal portion; or several such partitions may be formed. By far the greater number of

such spiral shells are *dextral*, *i.e.* if we begin at the apex of the

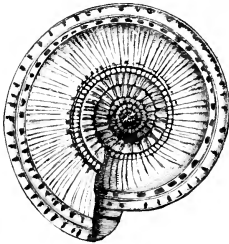

FIG. 630.—Shell of *Solarium perspectivum*, from the under side. (From the *Cambridge Natural History*.)

spiral to reach the opening of the shell we have to pass from left to right, with the columella always on our right-hand side: in a few cases, however, the spiral is *sinistral*, taking the opposite direction from that of the ordinary dextral shell. The form of the shell varies with the degree of obliquity with which the whorls are set on the axis. When the obliquity is very slight (Fig. 630) the spiral is nearly flat; when the obliquity is great, an elongated tapering shell such as that represented in Fig. 631 is the result. Sometimes the later whorls completely cover over the earlier ones,

so that the spiral form of the shell is concealed. Sometimes only the apical portion of the shell is spiral, the remainder being a straight or sinuous cylinder. The spiral form of the shell and the parts enclosed in it, as well as the direction of the spiral, whether dextral or sinistral, are, it may be here pointed out, very fundamental features of the organisation of the Gastropod, and are foreshadowed at an early stage in the segmentation of the ovum. The mouth of the shell has usually a prominent margin or *peristome*, which is sometimes entire and continuous, sometimes broken by a deep notch or a spout-like process or canal, formed in connection with the development of a spout-like prolongation of the mantle, the *siphon*, which lies in it. The mouth of the shell in many Gastropoda is capable of being closed by means of an *operculum* borne on the foot. In some terrestrial forms in which an operculum is absent, the opening may be closed up during winter by a layer of hardened mucous matter to which the name of *epiphragm* is applied. The margin of the mantle in some cases bears a series of *tentacles*. Lateral folds of the mantle are in some of the Gastropoda (Fig. 632) reflected over the shell and may completely cover it. In some cases these folds unite by their edge, so that the shell comes to be enclosed in a complete sac of the mantle; such enclosed shells are always imperfectly developed and incapable of covering the body. Thus in *Aplysia* and some other Opisthobranchs the shell



FIG. 631.—Shell of *Terebra oculata*.

is greatly reduced, thin and horn-like, and concealed within the mantle, while in the nudibranch members of the same sub-order it is entirely absent (Fig. 633). The shell is also completely absent in some of the pelagic forms (*Heteropoda* and *Pteropoda*); in others, though present and external, it is too small to enclose the animal (Fig. 634). In the slugs, among the Pulmonata, the shell is vestigial and in most cases is concealed by the mantle (Fig. 635).

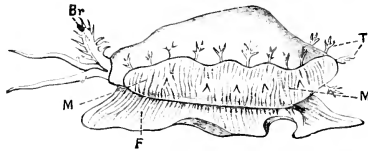

FIG. 632.—*Cypraea moneta* (Cowrie). Showing the mantle, provided with marginal tentacles, partly enveloping the shell. *Br.* siphon; *M.* mantle; *F.* foot; *T.* tentacles at the edge of the mantle. (From Cooke, after Quoy and Gaimard.)

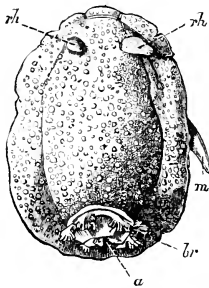

FIG. 633.—*Doris (Archidoris) tuberculata*. *a.* anus; *br.* branchiae; *m.* penis; *rh.* tentacles. (From the Cambridge Natural History.)

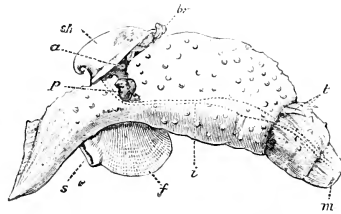

FIG. 634.—*Carinaria mediterranea*. *a.* anus; *br.* branchia; *f.* foot; *i.* intestine; *m.* mouth; *p.* penis; *s.* sucker; *sh.* shell; *t.* tentacles. (From the Cambridge Natural History.)

of the class. It usually presents an elongated flat ventral surface on which the animal creeps by wave-like contractions of the muscular tissue. An exceptional case is that of Cæcum, in which

the creeping movement is entirely due to the action of cilia covering the ventral surface. In the typical Gastropods the foot is usually distinguishable into three parts, a middle part or *mesopodium*, which is the most important, with a smaller anterior *propodium* and posterior *metapodium*. In many burrowing forms (Fig. 636) the propodium is well

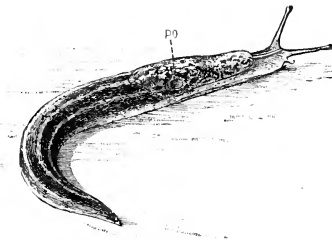

FIG. 635.—A Slug (*Limax*). *PO.* pulmonary aperture (From the Cambridge Natural History.)

developed and sharply marked off to act as a burrowing organ. In a few cases a pair of tentacles—the *pedal tentacles*—are situated at the anterior end of the foot; still rarer is a pair of similar appendages at the posterior end. The whole foot becomes reduced in the few Gastropods that remain fixed. The metapodium very usually

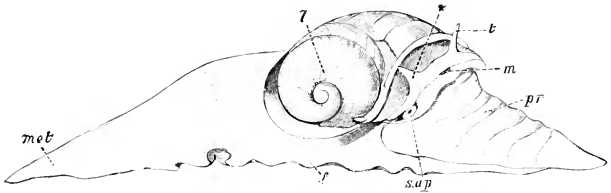

FIG. 636.—*Sigaretus laevigatus*, exemplifying great development of propodium (*pr.*) and metapodium (*met.*), in a burrowing Gastropod. The shell has been removed. *f.* mesopodium; *l.* "liver"; *s. ap.* aperture of siphon; *t. t.* tentacles. (From the *Cambridge Natural History*, after Quoy and Gaimard.)

in the Streptonera bears a disc or stopper—the *operculum* already referred to—usually horn-like, rarely completely calcified, more commonly horn-like with a thin calcareous investment—by means of which the aperture of the shell is closed when the animal is retracted.

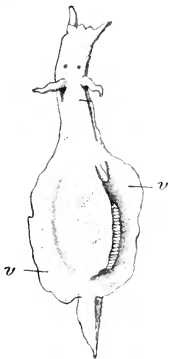

FIG. 637.—*Aplysia*, dorsal view. *p.* parapodia. (After Keferstein.)

In some forms, such as the Sea-hares (*Aplysia*, Fig. 637), the foot develops a pair of lateral lobes—the *parapodia*—which act as fins; and in the Pteropods (Fig. 638), which are specially modified for a pelagic existence, these constitute the largest part of the foot. In the Heteropoda (Figs. 639, 640), which are also pelagic, the foot is also modified to act as a swimming organ. In one family of this sub-order (Fig. 639) all three parts of the foot are well developed, the mesopodium bears a sucker, and the metapodium an operculum; in the rest the mesopodium is alone well developed and forms a laterally-compressed, vertically-elongated fin. The term *epipodium* is applied to a ridge or fold, which, when best developed, runs around the entire side of the foot, and may be beset with papillae or tentacle-like processes.

A *pedal gland* is present in the majority: it is a simple or branched invagination of the integument, lined by mucus-secreting cells. Very commonly, as in Triton, it opens on the exterior in the middle line of the ventral surface of the foot.

The Gastropoda have a well-marked **head**, separated from the body by a constriction or *neck*. The mouth, situated at the anterior

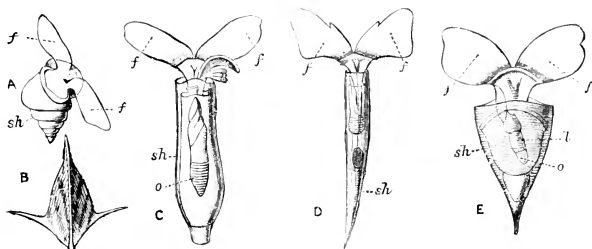

FIG. 638.—Shell-bearing **Pteropoda**. *f*, fins; *l*, liver; *o*, ovary; *sh*, shell. (From Cooke, after Souleyet.)

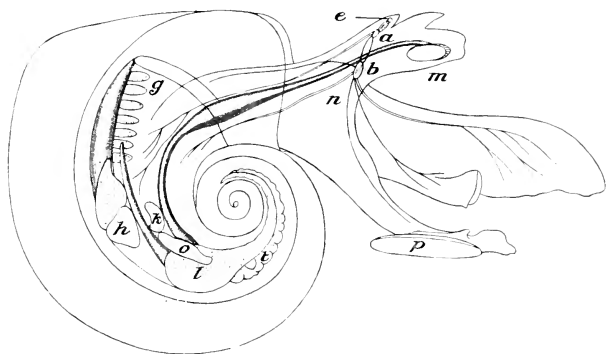

FIG. 639.—**Atlanta peronii**. *a*, cerebral ganglia; *b*, pedal ganglia; *e*, eye; *g*, ctenidia; *h*, heart; *k*, kidney; *l*, "liver"; *m*, mouth; *o*, ovary; *p*, operculum; *t*, testis.

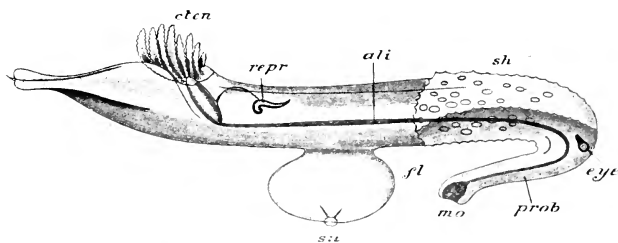

FIG. 640.—**Pterotrachea scutata**. *ali*, alimentary canal; *cten*, gills; *eye*, eye; *fl*, float; *mo*, mouth; *prob*, proboscis; *repr*, gonad; *sh*, shield covering a portion of the dorsal surface; *su*, sucker.

end of the head on its ventral aspect, is in many instances provided with a protrusible proboscis or *introvert*, sometimes of considerable length. In the dorsal surface of the head are a pair of tentacles which vary a good deal in shape, but are usually cylindrical or club-shaped. In most cases the eyes are situated on tubercles at the bases of the tentacles, or elevated towards the middle; but in the snails and slugs (*Pulmonata*, Fig. 641) the eyes are elevated on the extremities of a second, longer, pair of tentacles (*oc. tent*) placed behind the first.

The **mantle** is usually developed into a fold—the *mantle-flap*—originally posterior, but subsequently becoming shifted round, in the course of the displacement already referred to, to the right-hand side. This covers over a cavity—the *mantle-cavity*—situated anteriorly, in which are situated the anal and renal apertures and the ctenidia. The edges of the mantle-flap may become united together in such a way as to form a chamber opening on the exterior

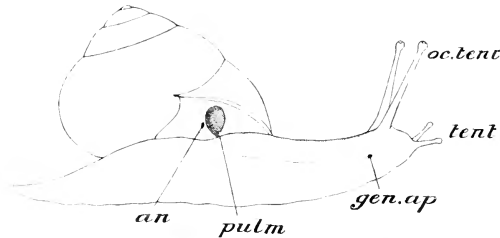

FIG. 641.—*Helix nemoralis*. *an*, anus; *gen. ap.*, genital aperture; *oc. tent.*, posterior eye-bearing tentacles; *pulm.*, opening of pulmonary sac; *tent.*, anterior tentacles. (After Pelseneer.)

by a comparatively narrow opening. In many of the Prosobranchia the edges of this aperture are drawn out into a spout-like prolongation open ventrally—the *siphon*—which lies in the corresponding prolongation of the peristome of the shell and serves as a channel for the ingress and egress of water. In some Gastropods, however, there is no definite mantle-cavity, the anus, nephridial apertures, and ctenidia merely lying under cover of a comparatively slightly developed lateral mantle-flap. Usually there is on the inner surface of the mantle a glandular area—the *pallial mucus-gland*.

Respiratory Organs.—There are typically two ctenidia, one on the right side and the other on the left, contained in the mantle-cavity; but in the great majority of the Streptoneura and branchiate Euthyneura the primitively right (actually left) ctenidium alone is retained. In those Gastropoda that possess two ctenidia, and in many forms with only one, the axis of the ctenidium bears two rows of compressed filaments, and is attached only towards its base. But in the majority of those with one ctenidium there

is, as in *Triton*, only a single row of filaments retained, and the organ is attached throughout its length.

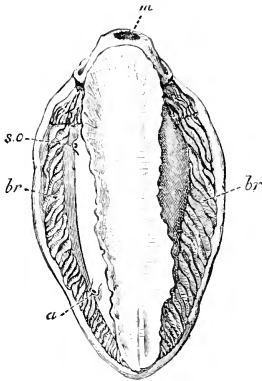

FIG. 642.—*Pleurophyllidia lineata*, from the ventral surface. *a*, anus; *br*, secondary branchiæ; *m*, mouth; *s. o.*, sexual opening. (From the *Cambridge Natural History*.)

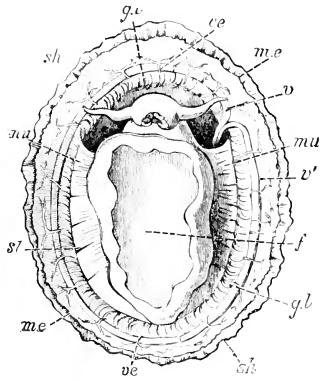

FIG. 643.—*Patella vulgata*, seen from the ventral side. *f*, foot; *g. l.*, circlelet of gill-lamellæ; *m. e.*, edge of the mantle; *mu*, attachment-muscle; *sl*, slits in the attachment-muscle; *sh*, shell; *v*, efferent branchial vessel; *v'*, aorta; *v'*, smaller vessels. (From the *Cambridge Natural History*.)

In the Nudibranchs true ctenidia are absent, but their place as breathing organs is taken by a number of *secondary branchiæ*, sometimes simple, sometimes branched or pinnate processes, which are distributed over the dorsal surface, as in *Eolis*; or, as in *Doris* (Fig. 633), form a circlelet surrounding the anus; or, as in *Pleurophyllidia* (Fig. 642), a row on each side beneath the mantle-flap.

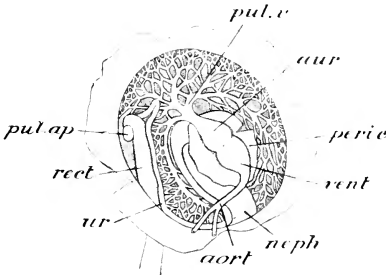

FIG. 644.—Pulmonary cavity and related parts in a slug (*Limax*). *aort.*, aorta; *aur.*, auricle; *neph.*, kidney; *peric.*, pericardium, laid open; *pul. ap.*, pulmonary aperture; *pul. v.*, pulmonary vein with its ramifications; *rect.*, rectum; *ur.*, ureter; *vent.*, ventricle. (After Pelseneer.)

In the limpets (*Patella* and its allies, Fig. 643) the true ctenidia are represented only by a pair of vestiges, and respiration is carried on by a number of secondary branchiæ (*g. l.*) in the form of lamellæ situated between the short lateral fold of the mantle

and the foot. In the *Pulmonata*, and in some members of other groups, ctenidia are absent, and the mantle-cavity, completely enclosed except for a small rounded opening, has the function of a **pulmonary sac** or **lung** (Fig. 614), its roof being richly supplied with blood-vessels: in the aquatic forms its function is apparently as much hydrostatic as respiratory. In one family of *Pulmonata*, the pulmonary chamber gives off a number of branching air-tubes or *tracheæ*. In some of the *Pulmonata* there is a return to a completely aquatic mode of respiration accompanied by the development of *secondary gills*—vascular processes of the wall of the mantle-cavity.

Near the base of each ctenidium is an elevation—the **osphradium**—corresponding to the body of that name in other Mollusca and having a similar function.

Digestive Organs.—In many *Streptoneura* there is a long *introvert*, capable of being everted and retracted, at the extremity of which the mouth is placed. A single curved horny jaw lies on the roof of the buccal cavity in the *Pulmonata*; in most *Streptoneura* (as in *Triton*) the place of this is taken by two lateral pieces.

A characteristic feature of the alimentary canal of the *Gastropoda*, which, however, they share with some *Amphineura* and with the *Cephalopoda*, is the possession of an odontophore and radula, a typical example of which has been described in that of *Triton*. In the different groups differences are observable in the odontophore as regards the proportions of the parts, and the size, form, and arrangement of the teeth. The structure and relations of the alimentary canal are similar to those already described in *Triton*, and salivary glands and “liver” (hepto-pancreas) are always present. The former may be tubular, but are usually botryoidal: the latter varies in relative extent and in the arrangement of its lobes in different forms.

In some *Opisthobranchia* the stomach contains a series of teeth which are sometimes sharp and chitinous, sometimes plate-like and calcified. Frequently a special development of the cuticular lining of the stomach forms a hard rod—the *crystalline style*, lodged in a cæcum and comparable to the body of the same name in the *Pelecypoda* (p. 687). A pyloric cæcum is frequently appended to the stomach. The intestine is long and thrown into folds in the vegetable-feeding forms, short and straight in the carnivorous. In some cases, *e.g.* *Haliotis*, it traverses the ventricle, in others the pericardium; in others it passes through the nephridium. In *Eolis* (*Nudibranchia*) the stomach gives off a number of glandular cæca which penetrate into the interior of the secondary branchiæ or *cerata* on the dorsal surface; these cæca take the place of the “liver” of other *Gastropoda*. In some of the *Pectinibranchia* there is a peculiar *adrectal gland*, situated at the side of the rectum

and secreting a colourless fluid, which in *Murex* and *Purpura* turns purple on exposure to the air, and was anciently used as a dye—the “Tyrian purple.”

The **heart** is, as in other Molluscs, enclosed in a special cavity—the *pericardium*—a specialised part of the coelome, communicating with the cavity of the kidneys. It consists usually, as in Triton, of two chambers—auricle and ventricle; but in some, *e.g.* *Haliotis*, there are two auricles and a ventricle. In the Opisthobranchia, as already mentioned, it lies in front of the ctenidia; in the Streptoneura at the side or behind. Given off from the apex of the ventricle is a large vessel which soon bifurcates to form anterior and posterior aortæ. These are the main trunks of the arterial system, which is more highly developed than in the Pelecypoda; the finest branches terminate in sinuses, as in the latter class.

The **nervous system** varies considerably in the different groups in regard to the arrangement of the ganglia and their commisures and connectives.

In the majority the arrangement is nearly that which has been described as occurring in Triton. There is a pair of *cerebral ganglia* usually closely united, but in *Patella* (Fig. 645) widely separated, situated over the gullet, and giving off behind a pair of *visceral nerve-cords*,

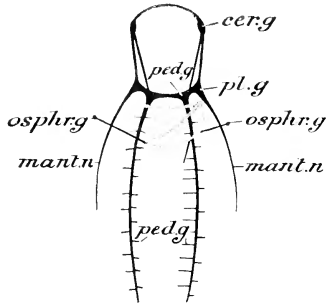

FIG. 645.—Nervous system of *Patella*. *cer. g.* cerebral ganglia; *mant. n.* mantle-nerves; *osphr. g.* osphradial ganglia; *ped. g.* pedal ganglia and pedal nerve-cords; *pl. g.* pleural ganglion. (After Spengel.)

in the course of which there is placed laterally a pair of *pleural ganglia*, and which are united together behind in a *median abdominal ganglion* (or a paired ganglion, as in Triton). In the course of these visceral cords there is also a pair of *visceral ganglia*. A pair of *pedal ganglia*, united together by a transverse commissure and joined to the cerebral and pleural ganglia by connectives, give off behind one or two pairs of pedal nerves, as already mentioned. A pair of *buccal ganglia* are connected by slender nerves with the cerebral. At the base of each osphradium is usually a small *osphradial ganglion* connected by a slender nerve with the visceral. In most Streptoneura (Fig. 629), in accordance with the torsion of the visceral mass, the visceral cords are twisted, as already described in the case of Triton, into a figure of 8: the right visceral ganglion becomes displaced to the left and comes to lie above the alimentary canal (supra-intestinal), while the

left becomes displaced to the right and comes to lie below the alimentary canal (infra-intestinal).



FIG. 646.—Nervous system of *Aplysia* (Opisthobranchia). *abd. g.* abdominal plus visceral ganglion; *cer. g.* cerebral ganglion; *osphr. g.* osphradial ganglion; *ped. g.* pedal ganglion; *pl. g.* pleural ganglion. (After Spengel.)

In *Patella* (Fig. 645) the pedal ganglia (*ped. g.*) give origin to a pair of elongated pedal nerve-cords. In *Haliotis* and *Fissurella* there is a similar pair of pedal cords which are connected together by transverse commissures, and, in the latter genus, join one another posteriorly.

In the Euthyneura (Fig. 646), except in *Actæon* and *Chilina*, the visceral cords are not caught up in the twist of the visceral mass, and do not cross one another. They unite behind in a ganglion (*abd. g.*) which represents both the abdominal and the supra-intestinal visceral.

In the Snails and other Pulmonata (Fig. 647) the ganglia of the nervous system are more closely aggregated together. A pair of cerebral ganglia overlie the œsophagus, and below it is a mass of ganglia in which are to be made out a pair of pedal ganglia and at least two pairs of ganglia representing the pleural and visceral. A pair of small buccal ganglia are connected with the cerebral by means of slender connectives.

The organs of special sense are the eyes, the statocysts, and the osphradia. In nearly all cases there are two cephalic eyes (Fig. 648), the position of which has already been referred to in the account given of the external characters. In structure they are simplest in *Patella* (A), where each consists of a pit-like depression, lined by pigmented cells connected with nerve-fibres. In the majority they have the structure described in the case of Triton. In certain species of *Oncidium*, a littoral Pulmonate, there are numerous eyes of a simple type scattered over the dorsal surface. In this case the optic nerve pierces the retina and the cells of the latter have their free ends directed away from the centre of the eye, as in *Pecten* (see p. 690) and in the Vertebrata, instead of towards it, as in other Mollusca. The internal cavity of the eye

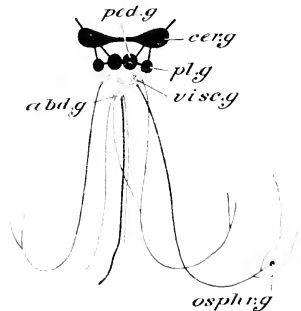

FIG. 647.—Nervous system of *Limnaeus* (Pulmonata). *abd. g.* abdominal ganglion; *cer. g.* cerebral ganglion; *osphr. g.* osphradial ganglion; *ped. g.* pedal ganglion; *pl. g.* pleural ganglion. (After Spengel.)

in *Oncidium* is occupied by a refractive body composed of a few large transparent cells.

The *statocysts* are usually placed in close relation to the pedal ganglia, but are always innervated from the cerebral. An *olfactory*

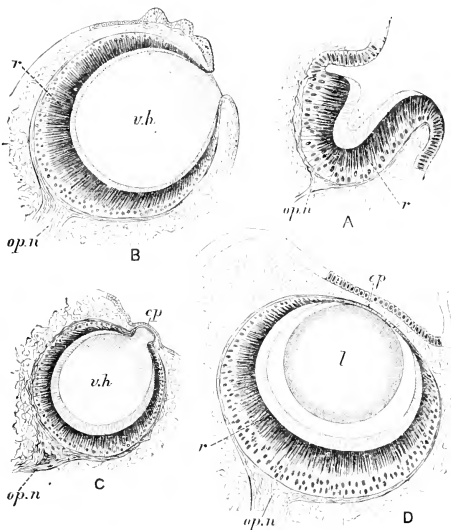

FIG. 648.—Eyes of Gastropoda. A, **Patella**; B, **Trochus**; C, **Turbo**; D, **Murex**. ep, epidermis; l, lens; op. n, optic nerve; r, retina; v. h., vitreous humour. (From the *Cambridge Natural History*, after Helger.)

organ is present in the shape of groups of cells on the tentacles, in which the fibres of an olfactory nerve terminate.

The *osphradia* are prominences, usually of simple form, situated

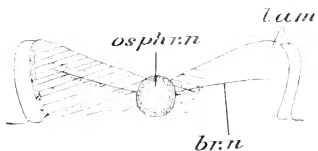

FIG. 649.—Transverse section of osphradium of **Murex**. br. n, branch nerve passing to lamina; lam, lamina; osphr. n, main osphradial nerve. (After Spengel.)

close to the base of the ctenidium. In many of the branchiate Streptoneura (Fig. 649), as already mentioned in the case of Triton (see p. 706, Fig. 623), the primitively right osphradium, which is alone developed, assumes the form of a pectinate body with a central ridge, on either side of which

is a row of close-set lateral laminae, and is commonly termed the *parabranchia* from its resemblance in appearance to a gill. In

some cases it is of even more complicated shape than in Triton, owing to the branching of the lateral ridges.

The **excretory organs** or **kidneys** of the Gastropoda are dorsally placed glandular tubes or chambers, which communicate internally with the pericardium, and open on the exterior, either directly or through a duct—the *ureter*. Both right and left kidneys may be present, though unequal in size, the one situated to the right of the anus being larger than that situated to the left; or

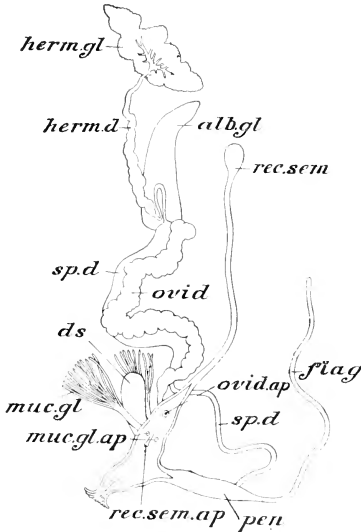

FIG. 650.—Reproductive organs of *Helix*. *alb.gl.* albumen-gland; *ds.* dart-sac; *flag.* flagellum of the penis; *herm.gl.* hermaphrodite gland or ovotestis; *herm.d.* duct of ovotestis; *muc.gl.* mucous gland; *muc.gl.ap.* apertures of mucous glands into vestibule; *ovid.* oviducal part of the common duct; *ovid.ap.* aperture of oviduct into vestibule; *rec.sem.* receptaculum seminis; *rec.sem.ap.* aperture of receptaculum seminis; *sp.d.* sperm duct; *sp.d'.* spermiducal part of common duct. (After Peiseneer.)

the former may alone be developed (*Euthyneura*). In a very limited number of Gastropoda the gonad opens into the kidney. The **sexes** are separate in nearly all the Streptoneura, united in the Euthyneura. Special gonoducts are present, except in one or two forms in which the nephridia perform that function. In the unisexual forms the reproductive apparatus is of a comparatively simple character, consisting merely of a racemose reproductive organ, ovary or testis as the case may be, situated dorsally in the visceral spiral, with the gonoduct opening far forwards on the right-hand side, and, in the male, a penis, which is grooved longitudinally and non-retractile. In the hermaphrodite forms, such as the Pulmonata (Fig. 650), on the other hand, a considerable degree of complexity is observable. There are an ovotestis or “hermaphrodite gland” (*herm.gl.*, Fig. 651, *A*)—some of the follicles of which produce ova while others produce sperms, a convoluted “hermaphrodite duct” (*herm.d.*), an albumen-gland, in which the albumen of the relatively large eggs is formed, and sometimes a separate oviduct and sperm-duct leading to a common genital opening;

sometimes there is a single duct undivided throughout; sometimes there is incomplete division. A receptaculum seminis (*rec. sem.*) is connected with the oviduct, and also a number of narrow accessory oviducal glands (*muc. gl.*); frequently a gland termed *prostate* is connected with the sperm-duct, and there are an eversible sac—the *sac of the dart* (*ds.*)—containing a crystalline stylet, and a *penis* (*pen.*), which is perforated by a canal and is capable of being retracted by a special muscle. In the Pulmonata the first part of the duct (“*hermaphrodite duct*” proper) is simple, and serves for the passage both of ova and sperms: the middle part is incompletely divided internally into two passages, one serving as oviduct, the other as sperm-duct. In the distal part oviduct and sperm-duct are completely separate. Where the sperm-duct enters the penis, there is given off a long, slender, tapering diverticulum, the *flagellum* (*flag.*), in which the sperms are made up into elongated masses or *spermatophores*.

Development.—

The limpets (*Patella*) are exceptional in laying the eggs one by one and unfertilised—impregnation taking place in the water after they have been discharged. In almost all the Gastropoda fertilisation is internal, and the eggs are laid in

great masses, embedded in jelly, each egg having its own hyaline envelope. Very often the mass of spawn consisting of the jelly-like substance, with the eggs embedded in it, attains a relatively considerable size. In form it varies greatly: frequently it is in the shape of long strings which are cylindrical or band-like: sometimes several such strings are twisted together into a cord. Sometimes the spawn is fixed to sea-weed or other objects; sometimes it is unattached, and may float about freely. In the Streptoneura (Fig. 652), instead of being embedded in a jelly-like mass, the eggs are enclosed in a firm parchment-like capsule, in which is contained, in addition to the eggs, a quantity of an albuminous fluid, serving to nourish the developing embryos. The shape of the capsule varies greatly in the different genera: sometimes it is stalked, sometimes sessile; in some cases there is a lid or operculum, the opening of which permits the embryos to escape. Very commonly large numbers of these capsules are aggregated together, and usually they are attached to a rock or a sea-weed or similar object. In

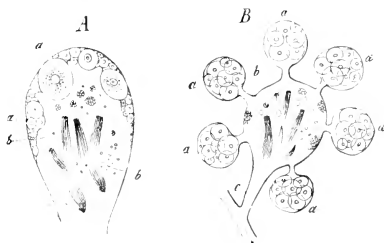

FIG. 651.—Follicles of the ovotestis of the Gastropoda. *A*, of *Helix hortensis* (Pulmonata); *B*, of the *Eolidæ*. *a*, ova; *b*, masses of sperms; *c*, common efferent duct. (From Gegenbaur.)

many cases only a limited number—sometimes only one—of the embryos contained in the capsule become developed, the rest serving as nutriment for the survivors.

In the land Pulmonata each ovum may be embedded in gelatinous matter enclosed in a firmer envelope, and a number of them are arranged in a string; sometimes a large number are embedded in a rounded gelatinous mass. Usually, as in some species of *Helix* and other genera, the outer layers of the albumen-like substance enclosing the egg become toughened and impregnated with salts of lime, so as to assume the character of a calcareous shell: a number of such eggs, which are of relatively considerable size, are laid in holes excavated in the earth.

In a few marine and fresh-water Gastropoda the ova undergo their development in the body of the parent, enclosed in an enlargement of the oviduct which serves as a uterus.

The egg contains a considerable quantity of food-yolk, which may be evenly distributed, or a clear protoplasmic and an opaque yolk-laden segment may be distinguishable. There is a fairly close agreement throughout the class in the nature of the segmentation (Fig. 653), which is very similar in the early stages to that of *Nereis* and the Chætopoda in general (p. 440) and to that of a Polyclad (p. 268). In all cases

it is total, sometimes equal at first, but soon afterwards becoming unequal. The first four blastomeres, A, B, C, D (cf. Fig. 219) are usually equal or nearly so. From these a succession of four quartettes of smaller cells (*micromeres*) become divided off, the larger cells being the *megameres*. The former then increase by division and form a cap of small cells (ectoderm) on the surface of the megameres. Of the cells of the fourth quartette, three become endoderm cells, contributing to the endodermal lining of the mesenteron. The fourth becomes the parent cell of the mesoderm.

The megameres themselves eventually become converted into endoderm cells with the exception of D, which, before becoming

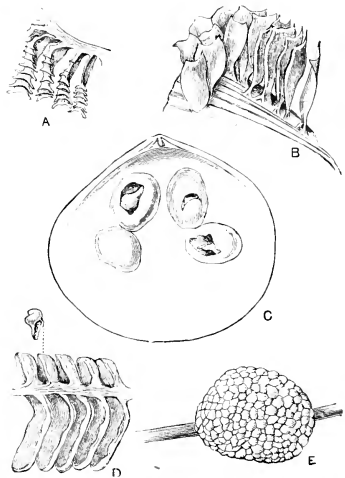

FIG. 652.—Forms of egg-cases in Gastropoda. A and D, *Pyruia* or *Busycon*; B, *Conus*; C, *Voluta musica*; E, *Ampullaria*. (From the Cambridge Natural History.)

an endoderm cell, gives off externally its daughter-cell of the fourth quartette destined, as in the Polychæta (p. 441), to give rise to the mesoderm. A segmentation-cavity is developed between the micromeres and the megameres, and the result is the formation of the blastula, one side of which (*vegetal pole*) is greatly thickened owing to its consisting of the large megameres, the opposite side (*animal pole*) being made up of micromeres. This may become a gastrula by epiboly or over-growth of the

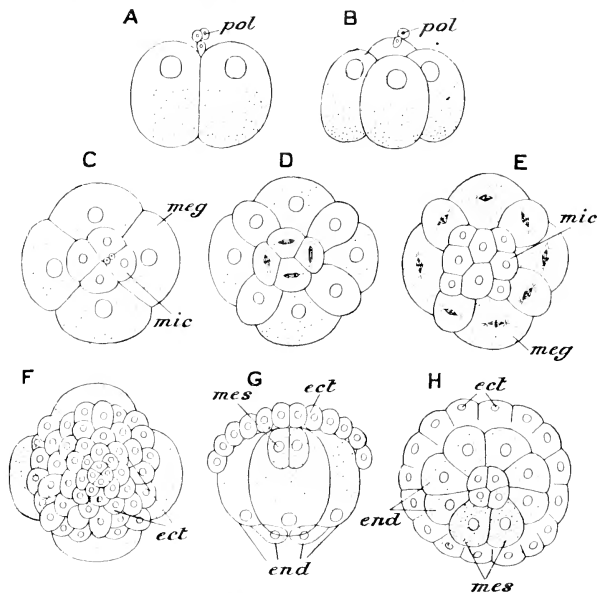

FIG. 653.—Diagram of the segmentation and formation of the germinal layers of the Gastropoda. *A* and *B*, lateral view; *C*—*F*, viewed from the animal (upper) pole; *H*, from the vegetal (lower) pole; *G*, in optical section; *ect*, ectoderm; *end*, endoderm; *mic*, micromeres; *meg*, megameres; *mes*, mesoderm; *pol*, polar bodies. (After Korschelt and Heider.)

ectoderm over the megameres; or, if the segmentation-cavity is of considerable size (*Paludina*), an invagination takes place.

The two larval stages, the *trochophore* and the *veliger*, are characteristic of the development of the Gastropoda. The former is most typically developed in *Patella*; in other Gastropods it undergoes more or less modification. In *Patella* (Fig. 654) there is a ciliated blastula (*A*) which has on one side the large megameres. The latter become enclosed by the micromeres, and the foundation of the mesoderm is laid in the manner already described. The

blastopore is situated at the vegetal pole, destined to become the hinder end of the larva, but it soon changes its position and extends forwards on the ventral side, and a ciliated ring—the *prototroch* or future *velum*—is formed. Subsequently the position of the blastopore becomes still further shifted and its form U-shaped and then slit-like. It undergoes elongation (Fig. 655, *A*) and

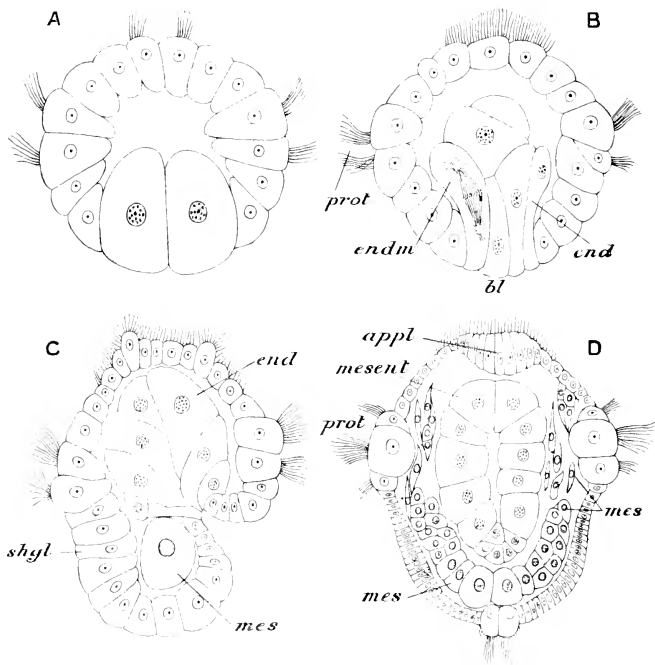

FIG. 654.—Earlier stages in the development of *Patella*. *A*, blastula; *B*, beginning of endodermal invagination; *C*, completion of gastrula; *D*, frontal section of somewhat later stage. *ap. pl* apical plate; *bl*, blastopore; *endm*, endo-mesoderm cell; *end*, endoderm; *mes*, mesoderm; *mesent*, mesenteron; *prot*, prototroch; *sh. gl.* shell-gland. (From Korschelt and Heider, after Patten.)

eventually becomes partly closed up, the closure taking place from behind forwards; in most cases in the position of the anterior part a sinking-in of the ectoderm forms the rudiment of the stomodæum. The originally solid mass of endoderm develops a lumen, and its cells become arranged to form the enteric epithelium. From the posterior end, where the mesoderm cells are situated, proceed two very regularly formed mesoderm-bands (Fig. 655, *B*).

On the dorsal surface the shell-gland has already appeared as a pit lined by elongated ectoderm cells ; on the surface of this appears

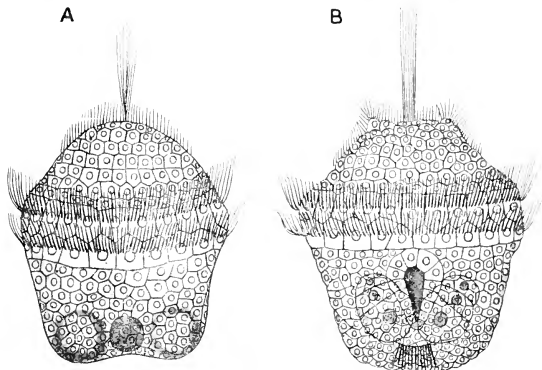

FIG. 655.—*A* and *B*, Trochophores of *Patella* at different stages. In *A* are to be seen the circular blastopore and the two foot-elevations ; in *B* the blastopore is drawn out, at the sides of it are the two mesoderm bands. (From Korschelt and Heider, after Patten.)

the embryonic shell. The rudiment of the foot (Fig. 655, *A*) arises at a remarkably early stage as two protuberances lying on the ventral side of the larva at the sides of the blastopore ; these coalesce to form the median foot.

The larva (Fig. 656) has now assumed the trochophore form. The pre-oral part is large and convex, with an apical plate on which is borne a bunch of long cilia, and near it two small ciliated elevations, each consisting of a single cell. The pre-oral part of the larva then becomes much flattened, and the apical plate (*ap. pl.*) increases in size and importance. At the posterior end is a bunch of

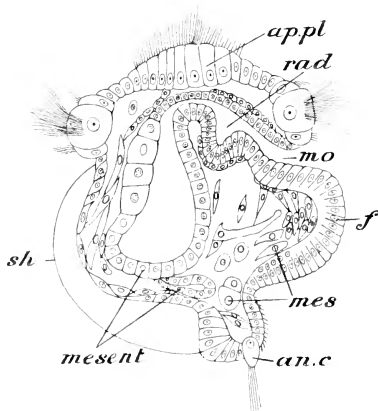

FIG. 656.—Later trochophore of larva of *Patella* in longitudinal section. *an. c.* anal cells with cilia ; *ap. pl.* apical plate ; *f.* foot ; *mes.* mesoderm cells ; *mesent.* mesenteron ; *mo.* mouth ; *rad.* rudiment of radula-sac ; *sh.* shell. (From Korschelt and Heider, after Patten.)

cilia which are borne on two special large cells, the *anal cells* (*an. c.*). The embryonic shell becomes saucer-shaped. A slight ridge in the neighbourhood of the shell represents the border of the mantle. The mid-gut (*mesent*) has become considerably widened: a diverticulum from it is recognisable, and this afterwards opens on the exterior to form the anus. A diverticulum of the fore-gut (*rad*) at the same time forms the rudiment of the radular sac. The statolith-sacs appear as depressions of the ectoderm at the sides of the mouth: these grow inwards and become sac-like, subsequently lying at the sides of the foot, which has meantime attained a considerable size.

The trochophore-stage, which is so well marked in the case of *Patella*, occurs in other Gastropods, though, as a rule, presenting

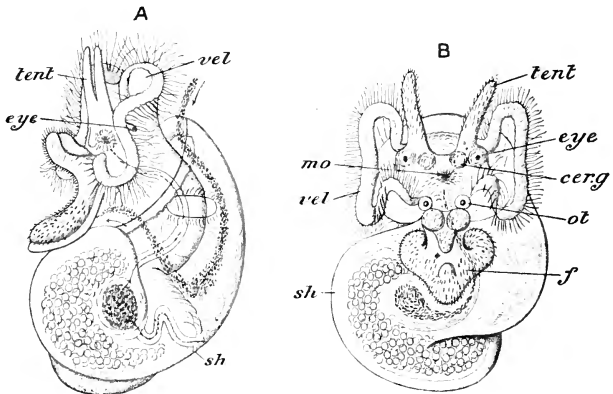

FIG. 657.—Veliger stage of *Vermetus*. *cer. g.* cerebral ganglia; *eye*, eye; *f.* foot; *mo.* mouth; *ot.* statocyst; *sh.* shell; *tent.* tentacle; *vel.* velum. (After Lacaze-Duthiers.)

modifications perhaps traceable to the enclosure of the embryo in an egg-shell and to the presence of much food-yolk. The history of the blastopore is not the same in all cases; in *Paludina* it becomes converted into the anus; in some the mouth is developed from its anterior portion; in others the stomodæal invagination arises after its complete closure, or may, with the mantle-cavity, only become developed after the symmetry has been disturbed by torsion. In most of the Gastropoda the pre-oral circling or velum (Fig. 657, *vel.*) undergoes a development not observable in the Pelecypod embryo, and becomes greatly extended as a bilobed flap, the strong cilia with which it is bordered rendering it a very efficient organ of locomotion for the larva. With the full development of the velum the larva passes into the veliger stage (Fig. 657). In this

stage the shell (*sh.*) increases in size, loses its simple form, and begins to develop a spiral. A cleft-like depression in the border of the mantle on the right-hand side forms the rudiment of the mantle-cavity in which, later, the gills are developed. The anus when it first appears may be symmetrically placed, but later becomes shifted to the right side and forwards as well as dorsally. A pair of *larval nephridia* are developed, having a remarkable resemblance to the larval nephridia of the trochophore of Polychæta, but of mesodermal origin. Each consists of a longer or shorter tube, usually intra-cellular, opening on the exterior at one end, and at the other terminating in one or several solenocytes. The foot (*f.*) may attain a considerable development during the veliger stage, and on its posterior and dorsal part appears the operculum. Two little processes on the velar area develop into the tentacles (*tent.*), and the eyes (*eye*) appear at their bases. As the foot and other organs advance in development the velum decreases in size and gradually aborts, but in some cases a portion of it persists as the subtentacular lobes or labial tentacles in the neighbourhood of the mouth.

In the Pulmonata the velum is not well developed, except in *Oncidium*, though the trochophore stage is well marked.

The young Gastropod is at first bilaterally symmetrical; the prevailing asymmetry is the result of unequal growth of the two sides of the body. In the majority of cases it is the left side that grows more actively than the right, a result of which is that the posterior parts—the anus and the region surrounding it—are displaced forwards towards the right, the space between the anus and the mouth on that side undergoing little or no increase in length. In the Opisthobranchia and the Pulmonata the anus with the mantle-cavity and its contents become displaced forwards towards the anterior end; in most of the Streptoneura the anus, &c., in their displacement forward pass beyond the middle line, one of the most striking effects of which is the crossing of the pleuro-visceral connectives already referred to.

Ethology and Distribution.—Only a few aberrant families of Gastropoda are parasites. Most are aquatic, all the most primitive forms being inhabitants of the sea. Of the marine families the majority move by creeping over the sea-bottom, some burrowing in mud or sand, some in solid rock; some are able to float in a reversed position, adhering to frothy mucus secreted by the glands of the foot; certain exceptional forms such as *Vermetus* are fixed in the adult condition by the substance of the shell. A few families—the Heteropoda and the Pteropoda—are specially modified for a pelagic mode of existence, and swim through the water by flapping movements of the lobes of the foot, which act as fins. Gastropods are found in the ocean at considerable depths—up to nearly 3,000 fathoms. Many forms, however, are

inhabitants of fresh water, while many Pulmonata are terrestrial, and occur even towards the summits of the highest mountains.

Fossil Gastropoda are known from almost the earliest fossil-bearing rocks, and all the major divisions of the class are represented in formations of Palaeozoic age.

The mutual relationships of the various groups of Gastropoda are shown in the following diagram (Fig. 658) :—

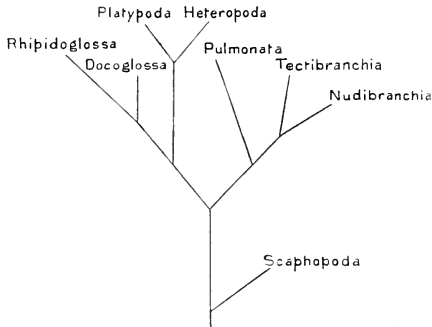

FIG. 658.—Diagram to illustrate the relationships of the **Gastropoda**.

APPENDIX TO THE GASTROPODA.

CLASS IV.—SCAPHOPODA.

The Scaphopoda or Elephant's tusk-shells are aberrant marine Molluscs comprising only three genera—*Dentalium*, *Siphonodentalium*, and *Pulsellum*. The body is elongated so as to be almost worm-like, with complete bilateral symmetry. The mantle-folds are almost completely united to form a cylindrical tube enclosed by the shell (Fig. 659), which is in the form of a delicate, curved tube, open at both ends and wider at the anterior or oral end than at the other. The foot (Fig. 660, *f*) is narrow, trilobed at the



FIG. 659.—**Dentalium**, longitudinal section of shell. (After Kesterstein.)

extremity or provided with a terminal disc, capable of being protruded through the oral opening of the shell, and used for burrowing in sand. The mouth is situated on a short oral proboscis, and is sometimes surrounded by lobed processes or pinnate palpi. Further back are a pair of tentaculiferous lobes,

each bearing a large number of filiform tentacles, which are probably respiratory in function. The mouth leads into a buccal cavity containing an odontophore. Connected with the mesenteron is a large bilobed digestive gland (*l*). The anus is situated ventrally behind the base of the foot. The vascular system is extremely simple, consisting of sinuses without definite walls, and there is no distinct heart, though in the neighbourhood of the rectum there

is a specially contractile part of the principal sinus. Two tubes open near the anus, the right one acting as a gonoduct, the left (*k*) entirely renal in function. The sexes are distinct. There is an elongated unpaired gonad (*g*), divided by lateral incisions into a number of lobes, occupying all the posterior and dorsal parts of the body. Anteriorly it narrows to form the gonoduct.

The nervous system consists of paired cerebral, pleural, pedal, and visceral ganglia; the cerebral ganglia are situated close together. There are no eyes or statocysts.

In the gastrula stage the embryo, which is provided with cilia, becomes free. The ciliated cells are arranged in a characteristic manner in three rows which, at first situated close together about the middle of the body, become shifted at a later stage near the apical pole, and amalgamated into a broad band representing the pre-oral cirlet of other molluscan larvæ; at the same time a bunch of cilia previously developed at the apical pole becomes more conspicuous and a considerable part of the general surface covered with more delicate cilia. The blastopore, at first terminal, is shifted forwards on the ventral surface until it comes to be immediately behind the ciliated cirlet. At its anterior end an invagination gives rise to the mouth and stomodæum.

The larva (Fig. 661) has now attained the stage of a trochophore, in which, however, both apical plate and primitive nephridia are wanting. A shell-gland is developed, and soon the rudiment of the shell appears. The post-oral region, at first inconsiderable in size, soon undergoes an increase, until it forms eventually by far the longest part of the body, while the pre-oral region almost completely aborts. When the post-oral region has attained a certain size, there are developed on it two lateral folds, the rudiments of the mantle (*B*), which grow inwards towards the middle ventral line, and later on unite by their free margins. The pre-oral cirlet or velum changes its form—at first it is conical, later it becomes plate-like, and is then gradually reduced, the

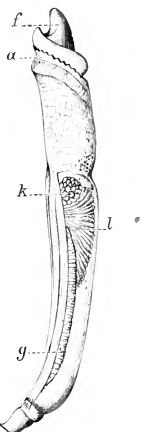

FIG. 660.—**Dentalium**, anatomy. *a*, anterior aperture of mantle; *f*, foot; *g*, gonad; *k*, kidney; *l*, digestive gland. (From the *Cambridge Natural History*, after Lacaze-Duthiers.)

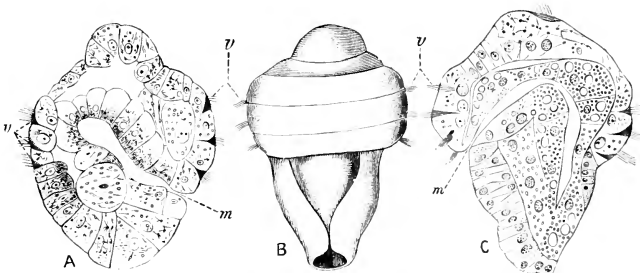

FIG. 661.—Veliger of **Dentalium**. *A*, longitudinal section of a larva 14 hours old; *B*, larva of 37 hours; *C*, longitudinal section of larva of 34 hours. *m*, mouth; *v*, velum. (From Cooke, after Kowalewsky.)

larva sinking to the bottom ; and though still occasionally swimming with the aid of the velum, coming to use the foot as a creeping organ. The shell now increases in size step by step with the growth of the mantle, and bends round the body of the larva until its edges meet and coalesce in the ventral median line. Later it assumes the elongated conical form, curved towards the dorsal side, characteristic of the adult. The foot at the same time elongates and takes on the characteristic three-lobed shape.

Class V.—CEPHALOPODA.

The *Cephalopoda*, including the Cuttle-fishes, Squids, Octopods, and Nautili, are marine Mollusca of a high grade of organisation. There is a very definitely-formed head, bearing a pair of highly-developed eyes, and surrounded by the anterior portion of the foot, modified into arms or tentacles. The body is bilaterally symmetrical. The posterior part of the foot is modified to form a funnel leading out from the large mantle-cavity. A shell is sometimes present, sometimes absent. When present it is usually internal, but sometimes external, and in the Nautili is capable of containing the body of the animal.

I. EXAMPLES OF THE CLASS.

i. THE CUTTLE-FISH (*Sepia*¹).

Cuttle-fishes are marine Molluscs, which live usually at a depth of a few fathoms, but often come into shallower water, and are frequently caught in the trawl or the seine. The animal arrests attention when compared with Unio or Triton by the strength, and more particularly the rapidity, of its movements ; by the possession of a pair of eyes resembling in size and complexity those of a Fish ; and by various other features, all pointing to a higher grade of organisation than is attained by the members of the classes of Mollusca dealt with in the preceding pages.

External Features.—The Cuttle-fish (Fig. 662) has a distinct *head*, bearing ten long arms, and a pair of large, highly-developed eyes. The head is connected with the body by a constricted region or *neck*. The *trunk* is elongated and shield-shaped, the base of the shield being towards the head. The long axes of head and trunk are in line with one another. Not only the head, but also the trunk, is completely equilateral, in which respect there is a marked contrast to Triton ; and this symmetry extends to most of the systems of internal organs. The free extremity of the head bears the mouth, and is accordingly termed the *oral* extremity, the opposite extremity, the apex of the shield-shaped body, is the *aboral* end. The surfaces of the shield are *anterior*

¹ Most of the figures have reference to a common Australian species—*S. cultrata*—but the differences between the various species of the genus are slight and unimportant, and the description given will apply fairly well to any other species.

or *antero-dorsal* and *posterior* or *postero-ventral*, its borders *right* and *left*. The anterior surface is to be distinguished by its darker colour, and by the firmness of the body-wall, due to the presence in this position of a hard internal shell.

The aperture of the mouth is surrounded by the bases of the ten *arms*. These are in pairs, situated to the right and left of the median plane. All of them, with the exception of the fourth pair (the most anteriorly situated pair being reckoned as the first), are stout at the base and taper towards the extremity. When extended they are about two-thirds of the length of the body. The outer surface of each (*i.e.* that turned away from the mouth) is strongly convex, the inner flat, and beset throughout its length with a number of *suckers*, which are arranged in four longitudinal rows. Each sucker is in the form of a shallow cup, supported on a short, thick stalk; the lip of the cup is membranous, and immediately within it is a narrow, horny rim. Into the floor and walls of the cup are inserted numerous muscular fibres. When the sucker is being brought into use it is firmly applied to the surface of the object; by the contraction of the muscular fibres the cavity of the cup is then enlarged, and a partial vacuum is formed, the result being firm adhesion, owing to the pressure of the surrounding water. The fourth pair of arms, usually known as the *tentacles*, are comparatively long and narrow, and provided with suckers only towards their free ends, which are somewhat thickened and club-like. In the male the fifth arm on the left side presents a slight modification, some of the suckers being absent. This is an indication of a change termed *hectocotylisation*, which, as will be pointed out in the general account of the class, assumes in some cases a very remarkable character. As the nerves which supply them are derived from the pedal ganglia, there is no doubt that

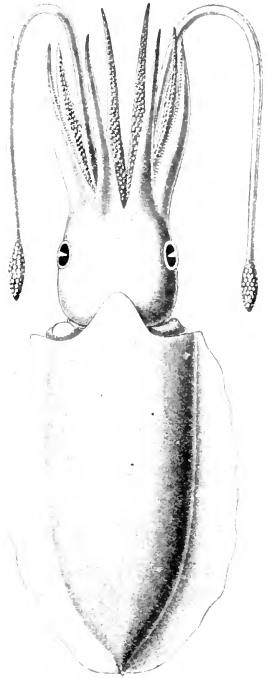

FIG. 662.—*Sepia cultrata*. Entire animal viewed from the antero-dorsal aspect.

the arms of *Sepia* represent a portion of the foot of other Molluscs ; but there is some doubt as to whether they correspond to the fore-foot or to the epipodia of the Gastropoda. The head-region, comprising as it does the arms (which are the chief part of the foot) and the head proper, is termed the *cephalopodium*.

The trunk is covered over by the thick integument of the *mantle*, which terminates toward the oral end in a ridge round the neck. Anteriorly this ridge projects as a prominent rounded lobe under cover of which the head can be partially retracted. Posteriorly it forms the oral lip of the opening of a large cavity bounded by the mantle—the *mantle-cavity*—which extends along the entire posterior face of the body almost to the apex. The wide cleft between the oral edge of the mantle and the posterior surface of the body is not the only aperture leading into the mantle-cavity.



FIG. 663.—Shell of *Sepia cultrata*, posterior view. Reduced.

On the oral side of this cleft is a large tube—the *funnel* (Fig. 667, *inf.*)—opening on the exterior behind the neck, and internally communicating by a wide aperture with the mantle-cavity. The cleft is capable of being almost completely closed by the apposition of a pair of oval projections (*mant. cart.*) of the inner surface of the posterior mantle-wall near its oral border, and a pair of concave depressions (*inf. cart.*) on the opposite (posterior) face of the funnel. The funnel is thus, under ordinary circumstances, the main outlet of the mantle-cavity. As such it not only carries to the exterior the effete water of respiration, the faecal matters from the intestine, and the products of the excretory and reproductive organs, but also takes an important part in locomotion, the most important movements of the Cuttle-fish—by which it darts rapidly through the water in the direction of the aboral pointed end of the body—being effected by rhythmical contractions of

the muscular walls of the mantle-cavity causing jets of water to be forced in the oral direction through the funnel. The free passage of water inwards through the funnel is prevented by the presence in its interior of a flap-like valve opening outwards. The water required for respiration and in locomotion is thus drawn in, not through the funnel, but through the partially-closed slit-like pallial aperture previously referred to. The funnel seems, from the source of the nerves which supply it, to be, like the arms, a specially modified part of the foot.

Fringing each lateral margin of the body is a thin muscular fold—the *fin*—which is used as a swimming organ.

The anterior wall of the body exhibits, as already mentioned, a hard and resistant character owing to the presence of the internal

shell (Fig. 663). This is completely enclosed in a sac of the mantle. Like the body itself, it is bilaterally symmetrical. In shape it may be described as leaf-like, with a rounded and comparatively broad oral end, and a narrower aboral end, provided with a sharp, anteriorly-projecting *spine*. The posterior surface is convex; the anterior convex towards its oral end, but deeply concave aborally, and bounded laterally by thin prominent wing-like ridges which converge to meet at the aboral extremity. The main mass of the shell consists of numerous, closely-arranged, thin laminae of calcareous composition, between which are interspaces containing gas. On the surface is a thin layer of chitinous material, and slightly thicker strips of similar composition run along the margins.

The living Cuttle-fish will be observed to undergo frequent changes of colour, and blushes of different hues are to be observed passing over the surface.

These are due to the presence of numerous contractile pigment-containing cells or **chromatophores** (Fig. 664) situated in the deeper layers of the integument over the entire surface. The chromatophores are flattened sacs with elastic walls, the contracting tendency of which is capable of being counteracted by the action of bundles of muscular fibres radiating outwards from the edge of the sac into the surrounding tissues. When these radiating fibres are in action the edge of the chromatophore is drawn outwards in different directions, and as a result the flattened

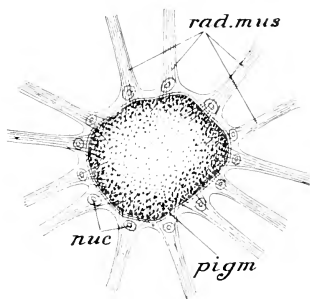

FIG. 664.—Chromatophore of *Sepia*, magnified. *nuc.* nuclei in wall of sac; *pigm.* pigment; *rad. mus.* radiating strands of muscle. (After Vogt and Jung.)

sac becomes more expanded and thinner, the pigment being spread out into a thinner layer. When the fibres are relaxed the elasticity of the wall comes into play, and the chromatophore contracts, the contained pigment resuming its former arrangement. A peculiar iridescence which, in addition to the play of colours, is recognisable in the integument of *Sepia* is due to the presence of a number of cells, the *iridocysts*.

When the **mantle-cavity** is laid open (Fig. 667) there is seen on each side of it one of the two plume-shaped *ctenidia* (*cten.*). In the middle line of the posterior surface, close to the internal opening of the funnel, is the *anal aperture* (*an.*) situated at the oral extremity of a longitudinal tube—the *rectum*. On either side of the rectum is a much narrower projecting tube with a terminal

opening—the *excretory aperture* (*neph.*). On the left-hand side is the opening of the sperm-duct or oviduct (*ovid.*) as the case may be.

In addition to the shell, which is an important protective structure, and gives support to the muscles of the fins, *Sepia* also has a remarkably well developed **internal skeleton** composed of cartilage. An important part of this—the *cranial cartilage* (Fig.

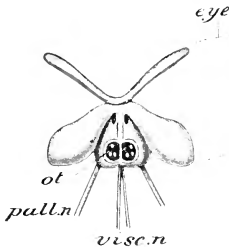

FIG. 665.—*Sepia cultrata*, cranial cartilage seen from the posterior aspect, with the cavities of the statocysts exposed. *eye*, position of eye indicated by dotted line; *ot.*, statocyst; *pall. n.*, pallial nerve; *visc. n.*, visceral nerves.

665)—protects the principal nerve-centres, encloses the statocysts, and gives support to the eyes. Other cartilages support the bases of the arms. A thin shield-shaped plate—the *nuchal cartilage* (Fig. 666)—lies on the posterior surface of the neck. The pair of elevations on the posterior wall of the funnel and the corresponding depressions on the anterior surface of the body are borne each on a thin plate of cartilage, and other thin cartilages support the bases of the fins.

Alimentary System.—The mouth is surrounded by a thin, lobed *peristomial membrane*, within which is a circular *lip* (Figs. 669, 672, *perist.*) beset with numerous papillæ. Lodged within the circular lip is a pair of powerful horny *jaws* (Fig. 668, Fig. 669, *jaw 1*, *jaw 2*; Fig. 670, *j.*; Fig. 672, *jaw*). These have somewhat the appearance of the beak of a parrot, the posterior jaw being larger and more strongly bent than the other, which it partly encloses. The mouth leads into a thick-walled buccal cavity, which contains an odontophore bearing numerous minute horny teeth. The *œsophagus* (Figs. 669 and 670, *œ*; Fig. 672, *œs*), following on the buccal cavity, is a narrow straight tube, which runs between the halves of the “liver” towards the aboral end of the body. It opens into a rounded thick-walled stomach (*st.*), and, close to the pyloric aperture leading from the latter into the intestine, opens a wide *cæcum* (*c.*). The alimentary canal at this point bends sharply round upon itself, and the intestine runs nearly parallel with the *œsophagus* to open into the mantle-cavity as already described.



FIG. 666.—*Sepia cultrata*, nuchal cartilage.

A pair of glands (Fig. 670, *s.g.*; Fig. 672, *sal.*), which are commonly termed *salivary*, though their functional correspondence with salivary glands has not been proved, are situated in the head behind the cranial cartilage. The ducts of these two glands run inwards and unite to form a median duct, which opens into the buccal cavity. The name of “*liver*” (Fig. 670, *l. l.*; Fig. 671,

liv.) or *digestive gland* is given to a large brown glandular mass which extends from the neighbourhood of the salivary glands nearly to the aboral end of the body. It consists of two partly united right and left portions, each of which has a duct opening into the cavity of the alimentary canal opposite the point where stomach, cæcum, and intestine meet. Surrounding the ducts and opening

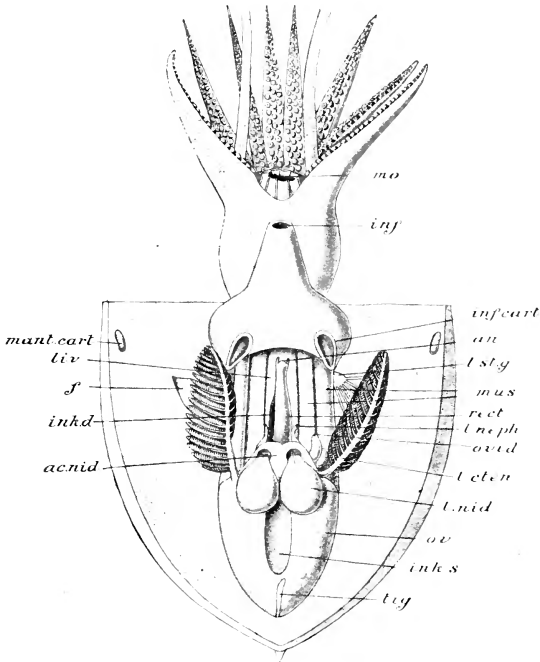

FIG. 667.—*Sepia cultrata*, female seen from the postero-ventral aspect, the wall of the mantle-cavity divided along the middle line and the two flaps thus formed spread out so as to expose the contents. *ac. nid.* accessory nidamental glands; *an.* anal aperture with its lateral appendages; *f.* membranous fold attaching the ctenidium to the wall of the mantle-cavity; *inf.* external opening of funnel; *inf. cart.* infundibular cartilage; *ink. d.* ink-duct; *ink. s.* ink-sac; *lig.* ligamentous band which extends from the anterior wall of the mantle-cavity to the ovary, cut across; *liv.* "liver"; *l. cten.* left ctenidium; *l. neph.* left renal aperture; *l. nid.* left nidamental gland; *l. st. g.* left stellate ganglion; *mant. cart.* mantle-cartilage; *mo.* mouth; *mus.* neck-muscles; *ov.* ovary; *ovid.* oviduct; *rect.* rectum.

into them are masses of minute vesicles (Fig. 670, *b, d.*); the secretion of these has the property of converting starchy matters into sugar; they sometimes, though without sufficient reason, receive the name of *pancreas*.

Immediately below the thin integument of the anterior wall of the mantle-cavity lies a characteristic organ—the **ink-sac** (Fig. 667, *ink. s.*; Fig. 670, *i.*). This is a pear-shaped body, a portion of the interior of which is glandular and secretes a black substance—the *ink* or *sepia*—which collects in the main cavity of the sac and is discharged by a cylindrical duct opening into the rectum close to the anal aperture. When the Cuttle-fish is startled it discharges the ink, which, mixing with the water in the mantle-cavity, is ejected through the funnel as a black cloud, under cover of which the animal may escape from a threatened attack.

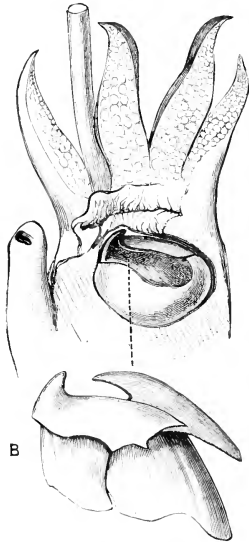

FIG. 668.—*Sepia officinalis*, jaws. A, *in situ*; B, removed and slightly enlarged. (From the Cambridge Natural History.)

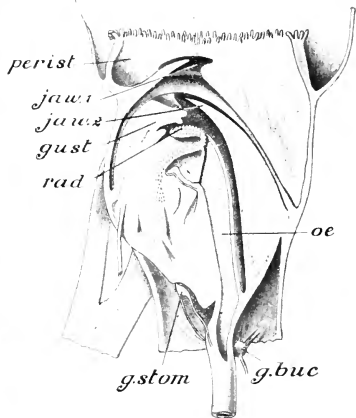

FIG. 669.—*Sepia*, median section through the buccal mass. *g. buc.* buccal ganglia; *g. stom.* stomato-gastric ganglia; *gust.* supposed gustatory organ; *jaw 1*, posterior jaw; *jaw 2*, anterior jaw; *oe.* oesophagus; *perist.* circular lip; *rad.* radula. (After Keferstein.)

Vascular System.—The *heart* (Figs. 671, 672, and 674) of the Cuttle-fish consists of a ventricle and two auricles. The *ventricle* (*vent.*), which is divided into two lobes by a constriction, is somewhat obliquely placed, but the rest of the vascular system is almost completely equilateral. At its oral end the ventricle gives off a large vessel—the *oral aorta* (*aort.*); aborally it gives origin to a much smaller *aboral aorta* (*aort'*), which bends over the ink-sac and supplies the aboral portions of the body. The arteries which lead off from the aortæ communicate by their ultimate branches with a system of capillaries, and these with a system

of veins. A large median vein, the *vena cava* (*v. cav.*), runs from the head to the neighbourhood of the rectum, in front of which it bifurcates to form the left and right afferent branchial veins (*l. aff. br. v.*, *r. aff. br. v.*), each running through the cavity of the corresponding renal organ to the base of the gill, where it is joined by veins from the aboral region. At the base of the gill the afferent branchial vein becomes dilated to form a contractile sac—the *branchial heart* (*r. br. ht.*)—appended to which is a rounded body of a glandular character—the *appendage* of the branchial heart, representing the pericardial glands of the Pelecypoda. The afferent branchial vein runs through the axis of the branchia, giving off branches as it goes. The blood is carried back to the ventricle on either side by a dilated contractile vessel, the *auricle* or *efferent branchial vein* (*l. aur.*, *r. aur.*).

The **cœlome** (Fig. 680) is a pouch of considerable size, divided by a constriction into oral and aboral parts. The former is the *pericardium*, or cavity in which the heart is lodged; it gives off a pair of diverticula, right and left, each lodging the corresponding branchial heart, and communicates by a pair of apertures with the cavities of the kidneys or renal sacs. The aboral part of the cœlome forms the capsule (*gonocœle*) which encloses the ovary or testis.

The paired, plume-shaped **ctenidium** lies parallel with the long axis of the body. It is attached throughout the greater part of its length to the wall of the mantle-cavity by a thin muscular fold, and consists of numerous pairs of delicate lamellæ, the surface of which is increased by the presence of a complex system of foldings. Internally the lamellæ are not completely in contact, an axial canal being left through which the water penetrates freely to all parts of the gill. The blood carried to the gill by the afferent branchial vessel passes in a system of minute branches through the lamellæ, and is gathered up again into vessels which open into the main efferent vessel leading to the auricle.

Nervous System.—Though parts homologous with those of Triton are recognisable in the nervous system of *Sepia*, their proportions and arrangement indicate a higher grade of organisation.

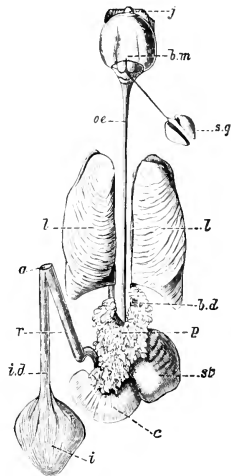

FIG. 670.—*Sepia officinalis*, enteric canal. *a.* anus; *b. d.* duet of one of the portions of the digestive gland; *b. m.* buccal mass; *c.* cœcum; *i.* ink-sac; *i. d.* ink-duct; *j.* jaws; *l.* digestive gland; *œ.* oesophagus; *p.* pancreatic appendages; *r.* rectum; *s. g.* salivary glands; *st.* stomach. (From the *Cambridge Natural History*.)

The *cerebral*, *pedal*, and *pleuro-visceral ganglia* (Fig. 675), all of relatively large size, are closely aggregated together around the œsophagus, supported and protected by the cranial cartilage. The *cerebral ganglia* (*cer. g.*) are fused together into a rounded mass, lodged in a hollow of the cranial cartilage, and covered over

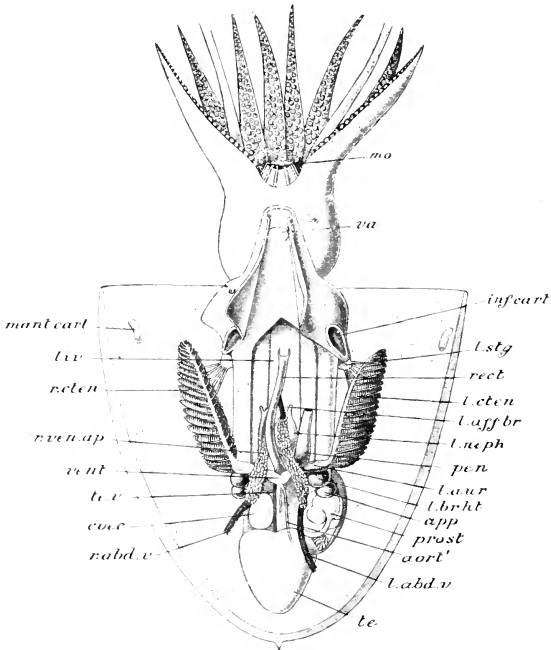

FIG. 671.—*Sepia cultrata*, male specimen seen from the postero-ventral aspect, the mantle-cavity opened as in Fig. 667, the posterior body-wall partly dissected off, so as to expose the organs in the visceral sac, the ink-sac and duct removed. *aort'*, aboral aorta; *app*, appendage of left branchial heart; *coc*, caecum; *inf. cart.*, funnel cartilages; *liv*, digestive gland; *l. abd. v.*, left abdominal vein; *l. aff. br.*, left afferent branchial vessel; *l. aur.*, left auricle; *l. br. ht.*, left branchial heart; *l. cten.*, left ctenidium; *l. neph.*, left kidney; *l. st. g.*, left stellate ganglion; *mant. cart.*, mantle-cartilage; *mo*, mouth surrounded by peristomial membrane; *pen*, penis; *prost.*, prostate; *r. abd. v.*, right abdominal vein; *r. cten.*, right ctenidium; *rect.*, rectum; *r. ven. app.*, appendages of right afferent branchial vessel; *te.*, testis; *te. v.*, vein to testis; *va.*, valve of funnel; *vent.*, ventricle.

anteriorly by a strong fibrous membrane. Laterally are given off a pair of short thick processes—the *optic nerves* or *optic stalks* (*opt. st.*)—which expand almost immediately into large masses—the *optic ganglia* (*opt. g.*)—in immediate contact with the eyes. At the sides and posteriorly a pair of very thick commissural

bands of nerve-matter pass round the œsophagus to unite with the pedal and pleuro-visceral ganglia, which lie behind. The *pedal ganglia* (Fig. 676) are, like the cerebral, united into a single mass; orally this is prolonged and expanded into a broad mass from which the ten *brachial nerves* (*br. n.*) are given off to the arms. The

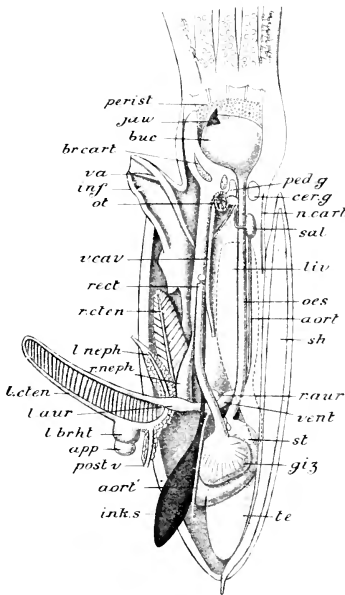

FIG. 672.—*Sepia cultrata*, lateral dissection of male. The left-hand half of the head has been removed by an approximately median longitudinal section, the buccal mass, however, being left intact; the funnel and the anterior and posterior walls of the mantle-cavity are likewise bisected longitudinally. The left ctenidium with the left renal sac and left brachial heart have been removed from their natural position and displaced backwards so as to expose the other organs. The digestive gland with its ducts and the pancreatic appendages have been removed, but the position of the former is indicated by a dotted line. *app.* appendage of left brachial heart; *aort.* aorta; *aort.* aboral aorta; *buc.* buccal mass; *br. cart.* section of cartilage supporting the arms; *cer. g.* cerebral ganglia; *giz.* cæcum; *ink. s.* ink-sac; *inf.* funnel; *jaw,* jaw; *l. aur.* left auricle; *l. br. ht.* left brachial heart; *l. cten.* left ctenidium; *liv.* position of digestive gland; *l. neph.* left renal sac; *n. cart.* nuchal cartilage; *oes.* œsophagus; *ot.* cavity of statocyst laid open; *ped. g.* section of pedal ganglion; *perist.* points to circular lip with peristomial membrane surrounding it; *post. v.* abdominal vein; *r. aur.* right auricle; *r. cten.* right ctenidium; *rect.* rectum; *sal.* salivary gland; *sh.* shell; *st.* stomach; *te.* testis; *va.* valve of funnel; *v. cav.* vena cava; *vent.* ventricle.

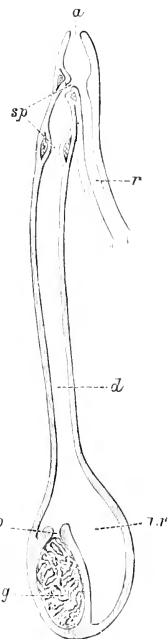

FIG. 673.—*Sepia officinalis*, longitudinal section of ink-sac. *a.* anus; *d.* ink-duct; *i. g.* ink-gland; *i. r.* cavity of ink-sac; *o.* orifice of ink-gland; *r.* rectum; *sp.* sphincter muscles. (From the *Cambridge Natural History*, after Girod.)

pleuro-visceral ganglia, also united into one, are in immediate contact with the pedal behind the œsophagus.

Besides the optic nerves the cerebral ganglia also give off a pair of slender nerves which join a smaller pair of closely united *buccal*

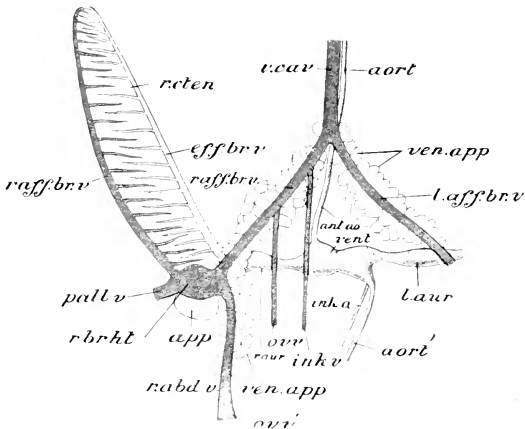

FIG. 674.—*Sepia cultrata*, heart and main blood-vessels from the posterior aspect. *ant. ao.*, aorta; *aort'*, aboral aorta; *app.*, appendage of right branchial heart; *eff. br. v.*, right efferent branchial vessel; *ink. a.*, artery to ink-sac; *ink. v.*, vein from ink-sac; *l. aff. br. v.*, left afferent branchial vessel; *l. aur.*, left auricle; *ov. v.*, deep ovarian vein; *ov. v'*, superficial ovarian vein; *pall. v.*, pallial vein; *r. abd. v.*, right abdominal vein; *r. aff. br. v.*, right afferent branchial vein; *r. eten.*, right etendium; *r. br. ht.*, right branchial heart; *r. cav.*, vena cava; *ven. app.*, venous appendages; *vent.*, ventricle.

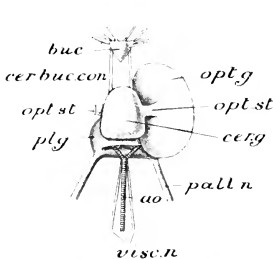

FIG. 675.—*Sepia cultrata*, cephalic ganglia, from the anterior aspect. *ao.*, aorta; *buc.*, buccal ganglion; *cer. buc. con.*, cerebral-buccal connective; *cer. g.*, cerebral ganglion; *opt. g.*, optic ganglion (removed on the left side); *opt. st.*, optic stalk; *pall. n.*, pallial nerve; *pl. g.*, pleural ganglion; *visc. n.*, visceral nerves.

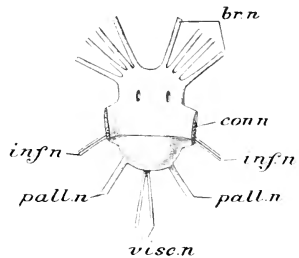

FIG. 676.—*Sepia cultrata*, anterior view of pedal and pleuro-visceral ganglia after removal of the cerebral and optic ganglia. *br. n.*, branchial nerves; *conn.*, connectives between the cerebral and the pedal and pleuro-visceral ganglia (cut across); *inf. n.*, nerve to funnel; *pall. n.*, pallial nerves; *visc. n.*, visceral nerves.

ganglia (Fig. 675, *buc.*), situated close to the buccal mass on the anterior aspect of the œsophagus. The buccal ganglia again (which are sometimes looked upon as separated portions of the

cerebral) are connected by slender connectives with a pair of *stomatogastric* ganglia (Fig. 669, *g. stom.*), also closely united, situated on the posterior aspect of the œsophagus. Besides the ten brachial nerves, each of which, expanding at the base of the arm into a *brachial ganglion*, runs along the axis of the arm to its extremity, the pedal ganglia also give off nerves to the funnel, and also a pair to the statocysts; but the latter are found, when their fibres are traced to their origin, to be derived from the cerebral ganglia. The pleuro-visceral ganglia give off two *visceral nerves* (Fig. 676, *visc. n.*) supplying the various internal organs, one pair of branches, the *branchials*, having each a branchial ganglion at the base of the

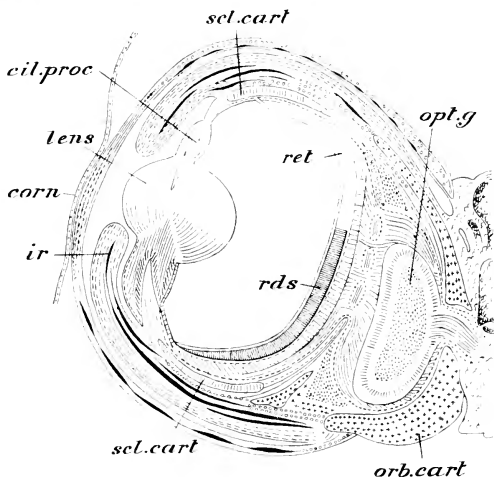

FIG. 677.—**Sepia**, section of eye. *cil. proc.*, ciliary processes; *corn.*, false cornea; *ir.*, iris; *lens*, lens; *opt. g.*, optic ganglion; *orb. cart.*, orbital cartilage; *rds.*, rods; *ret.*, retina; *scl. cart.*, sclerotic cartilage. (From Vogt and Jung, after Hensen.)

ctenidium, and running along its axis to its extremity. Two other ganglia of considerable size—the *visceral* and the *gastric*—occur in the course of this system. The pleuro-visceral ganglia also give off two very stout *pallial nerves* (*pall. n.*) which run through the neck to the inner surface of the mantle-cavity, where each expands into a large, flat, *pallial* or *stellate* ganglion (Fig. 667, *l. st. g.*), which is visible in front of the ctenidium when the mantle-cavity is opened. From the outer edge of this arise a number of nerves supplying the various parts of the mantle.

The **organs of special sense** of the Cuttle-fish are much more highly developed than those of Triton. The *eyes* (Fig. 677) are

supported by curved plates of cartilage forming a sort of orbit, connected with the cranial cartilage. The significance of the various parts of the eye will not be fully understood till the structure of that of the Vertebrata has been studied. A transparent portion of the integument covering the exposed face of the eye is termed the *false cornea* (*corn*). The eyeball has a firm wall, or *sclerotic*, strengthened by plates of cartilage (*scl. cart.*). Externally, *i.e.*, on the side turned towards the surface of the head, this presents a large opening—the *pupil*. The part of the sclerotic which immediately bounds the pupil is termed the *iris* (*ir.*); it contains muscular fibres by whose action the size of the pupil can, to a limited extent, be increased or diminished. Just internal to the iris and projecting slightly through the pupil is the *lens*—a dense glassy-looking body of a spherical shape. The lens consists of two plano-convex lenses in close apposition; it is supported by an annular process—the *ciliary process* (*cil. proc.*)—projecting inwards from the sclerotic. Between the two parts of the lens lies a thin layer of cells—the *cornea*. The lens with the ciliary process divides the cavity of the eye into two portions, a smaller outer—the cavity of the *aqueous humour*, containing water, and a larger inner, containing a gelatinous substance—the *vitreous humour*. Over the wall of this inner chamber extends the *retina* (*ret*), the sensitive part of the eye, in which the optic nerve-fibres derived from the optic ganglion terminate. The retina is of somewhat complicated structure, mainly composed of a layer of close-set parallel *rods* (*rds*), which immediately bound the cavity of the eye, with externally a layer of *retinal cells* which are in communication with the rods internally and with the *optic nerve-fibres* externally.



Fig. 678. — *Sepia cultrata*. Statolith, highly magnified.

In immediate contact with the eye, in addition to the optic ganglion, is a large soft body of unknown function, the so-called *optic gland* or *white body*. Bundles of muscular fibres bring about limited movements of the eyeball in various directions. An integumentary fold of the character of an eyelid is capable of being drawn to some extent over the false cornea.

The *statocyst* ("otocyst") (Fig. 665), though not of such complicated structure as the eye, is very much more highly developed than that of the Pelecypoda or Gastropoda. The two statocysts are embedded in the cartilage of the posterior portion of the cranium close to the pleuro-visceral ganglion. The cavities of the two organs, which are about 3 mm. in diameter, are separated by a median cartilaginous septum. The inner surface presents a number of rounded and pear-shaped elevations, and is lined with a flattened epithelium raised up on the posterior surface into a ridge or *crista acustica* and a *macula acustica* composed of large

cylindrical cells provided at their free extremities with short cilia, and produced at their bases into processes continuous with nerve-fibres derived from the statocyst-nerve. Enclosed in the cavity of the statocyst and attached to the macula is a large statolith (Fig. 678) of dense composition and complicated form. The function of the statocysts as organs of hearing is quite unproved; it has been shown by experiment that their removal leads to a loss of the power of co-ordinating the movements in such a way as to maintain the equilibrium.

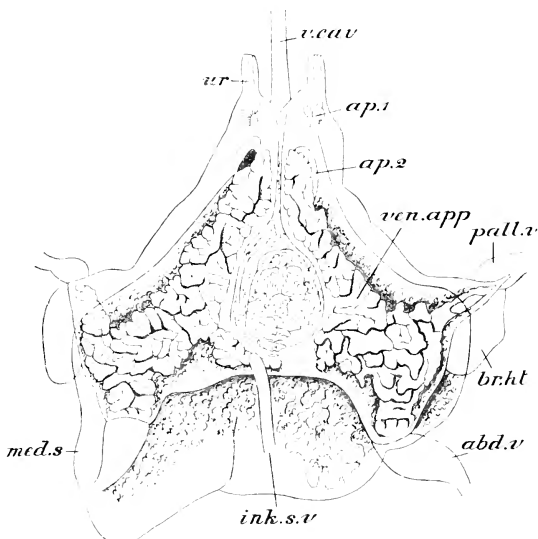

FIG. 679.—*Sepia officinalis*, excretory organs. *abd. v.* abdominal vein; *ap. 1*, funnel-like opening from the pericardium; *ap. 2*, aperture of communication between the left and the median renal sac; *br. ht.* branchial heart; *ink. s. v.* ink-sac vein; *med. s.* median sac; *pall. v.* pallial vein; *ur.* renal aperture (ureter); *v. cav.* vena cava; *ven. app.* venous appendages of the afferent branchial veins. (From Vogt and Jung, after Grobben.)

Supposed to be *olfactory* in function is a pair of ciliated pits, which open by slits on the surface behind each eye; among the ciliated cells lining the pit are numerous narrow sensory cells connected at their bases with the fibres of a nerve derived from a small ganglion situated close to the optic ganglion. A small elevation (Fig. 669, *gust*), covered with papillæ, on the floor of the buccal cavity just in front of the odontophore, is perhaps an *organ of taste*.

The **excretory organs** or **kidneys** of *Sepia* (Figs. 679 and 680) are a pair of thin-walled sacs, which open into the mantle-

cavity by the conspicuous excretory apertures already described. On either side is an aperture (*ap. l*) placing the cavity of the sac in communication with the pericardium, and the right and left sacs communicate with one another orally and aborally. From their posterior junction is given off a median diverticulum (Fig. 680, *med. s*), into which the pancreatic follicles (*panc.*) project. Through each excretory sac runs the corresponding *afferent branchial vein*, formed by the

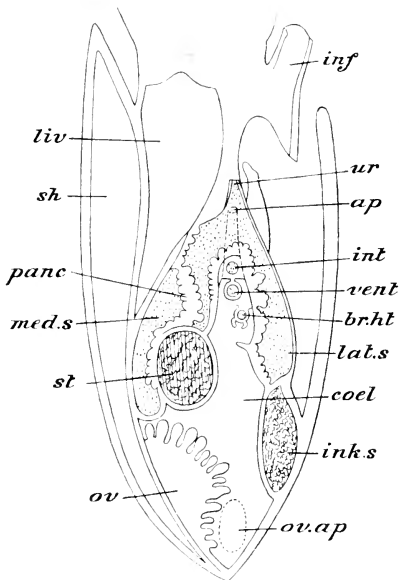

FIG. 680.—*Sepia officinalis*, diagram of a median vertical section of a female specimen, to show the relations of the cavities. *ap.* aperture between the secondary body-cavity (pericardium) and the lateral nephridial sac; *br. ht.* branchial heart; *coel.* coelome; *inf.* funnel; *ink. s.* ink-sac; *int.* intestine; *lat. s.* lateral nephridial sac; *liv.* liver; *med. s.* median nephridial sac; *ov.* ovary; *ov. ap.* aperture leading from oviduct to secondary body-cavity; *panc.* pancreatic appendages; *sh.* shell; *st.* stomach; *ur.* ureter; *vent.* ventricle. (From Vogt and Jung, after Grobben.)

the bifurcation of the vena cava, and surrounding it are masses of glandular tissue (Fig. 679, *ven. app*), by whose agency the process of renal excretion (the products of which, in the shape of a nitrogenous excretory substance called *guanin*, are to be detected in the internal cavity) is carried on.

Reproductive system.—In the male the *testis* (Fig. 681, *te.*) forms a compact mass of minute tubules situated in the aboral region of the body and enclosed in a capsule. The single spermiduct (*v. def.*) is a greatly convoluted tube which leads from the cavity of the capsule towards the left; it opens into an elongated *vesicula seminalis* (*ves.*), to which is appended a glandular body, the *prostate*

(*pr.*). In the interior of the vesicula seminalis the sperms are rolled up by the action of a system of grooves and ridges into long narrow bundles of about 2 cm. in length, each of which becomes enclosed by a chitinoid capsule of a narrow cylindrical shape, forming a *spermatophore* (Fig. 682, *B*); at one end of the spermatophore is a complicated apparatus of the nature

of a spring for causing the rupture of the wall and the discharge of the sperms. The vesicula seminalis expands into a wide sac—the *spermatophoral sac* or *Needham's sac* (Fig. 681, *sp. s.*)—in the interior of which the spermatophores are stored. This opens into the mantle-cavity by the aperture already described at the extremity of the penis to the left of the middle line.

In the female the *ovary* (Fig. 667, *ov.*) occupies a position corresponding to that of the testis in the male, and is enclosed in

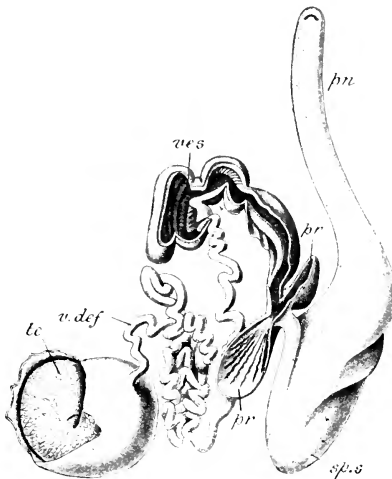

FIG. 681.—*Sepia*, reproductive organs of male. *pn*, penis; *pr*, prostate; *sp. s.*, sperm-sac; *tc*, testis; *v. def.*, vas deferens; *ves*, vesicula seminalis. (After Kieferstein.)

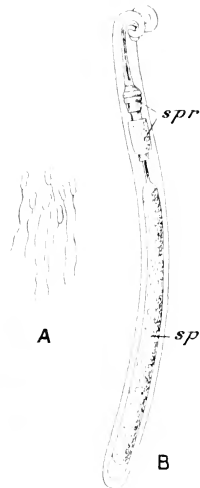

FIG. 682.—*Sepia*. *A*, sperm, highly magnified; *B*, spermatophore. *sp*, mass of sperms; *spr*, spring apparatus by which the wall of the spermatophore is ruptured. (From Vogt and Jung.)

a similar capsule, with the cavity of which the lumen of the oviduct is continuous.

An axial swelling bears numerous follicles, each containing a single ovum supported on a long slender stalk; the different ova are in various stages of development. At the breeding season the ovary becomes a compact mass of ova, which assume a polygonal shape owing to mutual pressure. The *oviduct* (*ovid.*) is a wide tube, opening, as already described, into the mantle-cavity to the left of the rectum. Occupying a conspicuous position on the anterior wall of the mantle-cavity of the female is a pair of large flattened glands of somewhat oval outline, the *nidamental glands* (*nid.*), situated to the right and left of the ink-duct. In the long axis of each is a median canal, on either side of which is a range of closely-

set delicate lamellæ; the median canal opens into the mantle-cavity by a slit bounded by a number of plaits situated at the narrower oral end. The nidamental glands secrete the viscid material by means of which the eggs when deposited adhere together in masses. A glandular mass of unknown function, known as the *accessory nidamental glands* (*ac. nid.*), lies at the sides and around the oral ends of the nidamental glands proper.

ii. THE PEARLY NAUTILUS (*Nautilus pompilius*).

The three living species of *Nautilus*, of which *N. pompilius* is the best known, are inhabitants of moderately shallow water about the shores and coral-reefs of the South Pacific, usually swimming

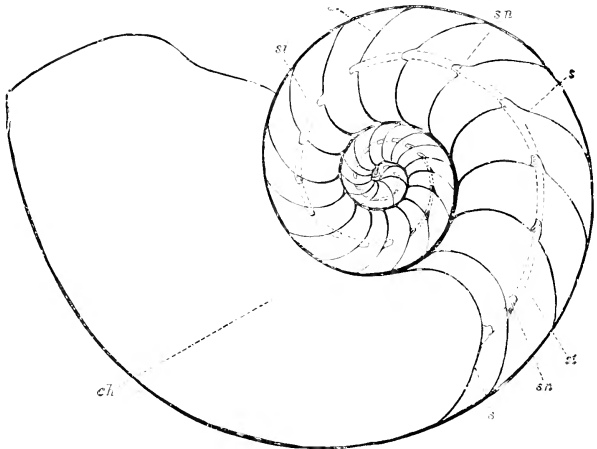

FIG. 683.—Section of the shell of **Nautilus pompilius**, showing the septa (*s.*), the septal necks (*s. n.*), the siphuncle, *si.* (represented by dotted lines), and the large body-chamber (*ch.*). (From the *Cambridge Natural History*.)

near the bottom, and probably rarely, if ever, coming voluntarily to the surface. The body is enclosed in a calcareous, spirally-coiled **shell** (Fig. 683), into which the entire animal can be withdrawn for protection. The cavity of the shell is divided by a system of *septa* into a series of chambers, the last and largest of which, opening widely on the exterior, alone lodges the body of the animal. Between the animal and its shell there is a direct organic connection through the intermediation of a narrow, tubular, vascular prolongation of the visceral region, which perforates the entire series of the septa to the apex of the spiral. This tube, which is termed the *siphuncle* (*si.*), has its wall supported by scattered

spicules of carbonate of lime ; but, in addition, as it passes through each septum, there is produced over it for some distance a shelly tube—the *septal neck* (*s. n.*)—continuous with the substance of the septum. The apical or initial chamber presents a small scar, the *cicatrix*, which may indicate the original presence of the larval shell, or *protoconch*, which has fallen off in the course of development.

When the shell of the Nautilus is compared with that of Triton some points of resemblance, together with important points of difference, will be at once recognised. In both the growth of the shell has taken place in such a way as to produce a gradual and regular increase in the width of the internal cavity, from the apex to the mouth, the result being a form of shell which, if it were straightened out, would be a long cone. In both the growth has not taken place in a straight line, but in a spiral, and a spiral of so close a character that successive turns are in immediate contact and their walls fused together. But in Nautilus all the turns of the spiral are in the same plane ; the spiral, in other words, is a flat one, as has already been found to be the case in certain of the Gastropoda (p. 718), whereas in Triton the spiral is an elongated helix : in other words, the spiral of Nautilus is that of a watch-spring, that of Triton that of a corkscrew. The possession by Nautilus of the series of septa marking the position which the animal has occupied at successive stages in its growth is another striking difference. Moreover the relations of the soft parts of the shell are radically different in the two cases. In Triton the body is attached to the shell by the columellar muscle ; in Nautilus the main organic connection is by means of the siphuncle ; for, though it is chiefly through the pressure exerted by two great lateral masses of muscle (Fig. 684, *mus.*) that the Nautilus retains its hold of the shell, the muscular fibres are not attached to the latter in the same intimate way as those of the columellar muscle of Triton, but are inserted into a horny cuticular membrane intervening between the muscle and the shell. Again, while the curvature of the body of Triton with the enclosing shell is towards the ventral side (*endogastric*), in Nautilus it is towards the dorsal side (*exogastric*).

When the animal is removed from the shell it is found to possess two regions, a distinct and relatively large, obtusely conical *head* bearing eyes and a system of tentacles, and a rounded sac-like *trunk*. Both head (or *cephalopodium*) and trunk are very slightly compressed, the direction of the compression being, as in Sepia, from the antero-dorsal towards the postero-ventral side, and they are almost completely bilaterally symmetrical, only a very slight disturbance of the symmetry being discernible. The mouth, situated at the free extremity, is provided with a pair of relatively enormous, partly calcified jaws (Fig. 684). Surrounding the mouth

is a series of bilaterally arranged lobes which represent the fore-foot or the epipodia of other Molluscs. These are beset with numerous slender, three-sided tentacles, each provided with an elongated tubular sheath, in the interior of which the greater part of the tentacle in the retracted condition lies enclosed, only a small portion protruding. Minute ring-like markings on the tentacle are due to the presence of a number of annular constrictions, which give the tentacle a transversely ridged character.

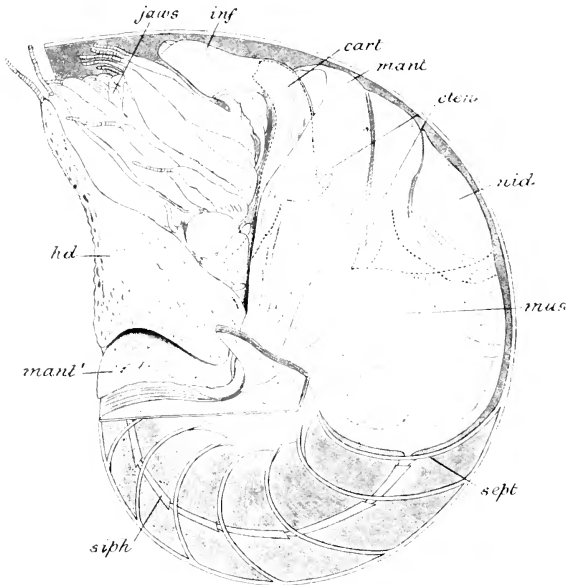

FIG. 684.—*Nautilus pompilius*, diagrammatic lateral view of a female specimen enclosed in its shell. *cart*, cartilage; *cten*, ctenidia; *hd*, hood; *inf*, funnel; *jaws*, jaws; *mant*, mantle; *mant'*, dorsal mantle fold overlapping the coil of the shell; *mus*, position of lateral mass of muscle; *nid*, nidamental glands; *sept*, first septum; *siph*, siphuncle. (After Kesterstein.)

There are no suckers: but the ridged surfaces enable the tentacle to adhere firmly to rough objects. The tentacles are arranged in two series, an outer and an inner. The outer, which are borne on an annular muscular ridge of the foot, are nineteen on each side in both sexes. Anteriorly this muscular ridge is thickened to form a massive lobe—the hood (Figs. 684, 685, *hd*.)—in which there is a concavity for the reception of the coil of the shell. The hood bears two tentacles, and has the appearance of being composed of the immensely developed sheaths of these, completely

fused together in the middle line: on each side the enlarged sheaths of a second pair of tentacles are closely applied to, though not completely coalescent with, the hood, being separated from the latter by a narrow groove. The hood, with these two enlarged sheaths, is covered with a thickened tuberculated skin, and acts

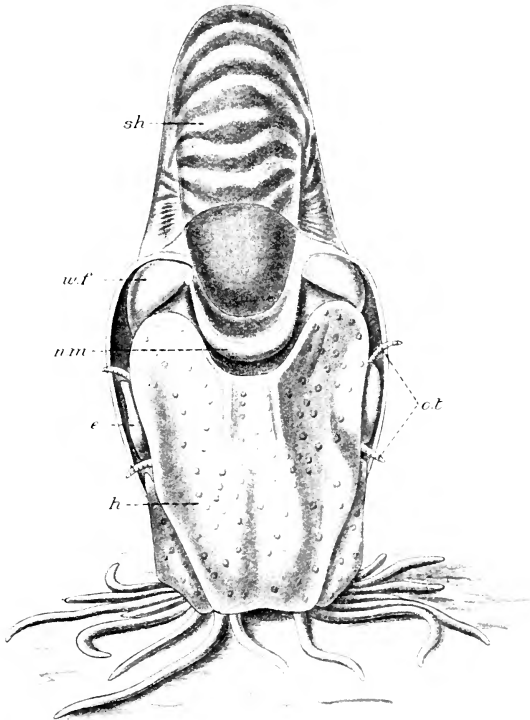

FIG. 685. — *Nautilus macromphalus*, adhering to the substratum in a vertical position by means of its tentacles. *e*, eye; *h*, hood; *n. m.*, nuchal membrane detached from coil of shell; *o. t.*, ophthalmic tentacles; *sh*, shell; *w. f.*, wing of funnel. (After Willey.)

after the manner of an operculum for protecting the tentacles and other soft parts about the head. Altogether there are forty-two tentacles of the outer series, including four *ophthalmic* tentacles, one situated on the oral and another on the aboral side of each eye. The latter (*ophthalmic*) differ from the rest in being highly

sensitive, ciliated, and with the ridges on the inner side produced into lamellæ. The tentacles of the inner series differ strikingly in number and arrangement in the two sexes. In the female there are two inner lateral lobes, right and left, quite symmetrically developed, each bearing twelve tentacles, and an inner posterior lobe (Fig. 686) divided by a deep median notch into two, each half bearing twelve to fourteen tentacles. On the middle of the oral surface of the latter, close to the median notch, is an oval patch raised up into numerous closely set ridges (*organ of Owen*).

In the male the inner posterior lobe with its ridged organ is only represented by a median posterior body consisting of two oval

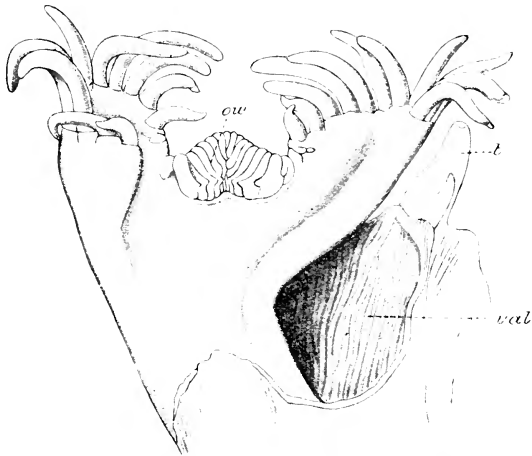

FIG. 686.—Inner posterior lobe of foot of female of *Nautilus pompilius*, with neighbouring parts of cephalopodium. *ow*, organ of Owen; *t*, one of the tentacles of the outer ring; *val*, organ of Valenciennes. (After Willey.)

elevations, each divided into a number of folds (*organ of van der Hoeven*). The internal lateral lobes are greatly modified, four of the tentacles on either the right side or the left, usually the latter, being modified to form a structure termed the *spadix* (Fig. 687), which is supposed to represent the hectocotyliised arm of the male *Sepia*. It has the form of a large compressed cone formed by the union of the enlarged sheaths of three of the tentacles. The corresponding tentacles themselves are in the adult male enormously thickened, and the outer surface of the most posterior (3) is covered with regularly arranged rows of minute pits. A fourth tentacle, much smaller than the others, is closely applied to the outer surface of the organ. In the internal lateral lobe, right or

left as the case may be, opposite that bearing the spadix, the latter is represented by a group of four tentacles forming what is termed the *anti-spadix*.

A further difference between the male and the female with regard to the foot is the presence in the latter, but not in the former, on the inner surface of the outer ring, close to the inner posterior lobe on either side, of an area thickly beset with delicate membranous ridges (*organ of Valenciennes*, Fig. 686, *val.*).

On the posterior side of the head is a funnel corresponding with that of *Sepia*, but extending further forwards; this, however, does not form a completely closed tube, the edges of its right and left moieties being simply in apposition posteriorly without being united together. Near the oral end is a large, somewhat triangular valve arranged like that of *Sepia*.

There is an internal skeleton of cartilage (Fig. 688), as in *Sepia*, but its relationships with the nerve-ganglia are much less intimate in the case of *Nautilus* than in that of *Sepia*.

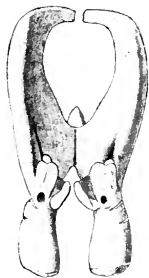

FIG. 688.—*Nautilus pompilius*, cartilaginous internal skeleton. (After Kieferstein.)

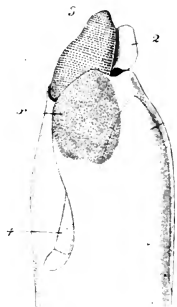

FIG. 687.—*Nautilus pompilius*, spadix of full-grown male, seen from the outer side. 1, 2, 3, 4, modified tentacles; 1, withdrawn into its sheath, its position and shape indicated by the dotted line; 3, the flattened tentacle with the rows of minute cavities; x, patch of modified integument. Two-thirds of the natural size. (After Haswell.)

Mantle and Mantle-cavity.—The mantle is produced around the head into a free flap, longer and looser than the mantle-flap of *Sepia*. Dorsally this splits into two layers, reflected over the convexity of the shell, which fits into a hollow behind the hood. Ventrally and posteriorly the mantle encloses a large mantle-cavity (Fig. 689), corresponding to that of *Sepia*. In this are lodged two pairs of ctenidia (*cten.*), having the same general structure as the single pair present in *Sepia*. Between the bases of the ctenidia of each side is a small knob-like elevation, the *oral osphradium* (*ant. os.*).¹ and behind the bases of the more aborally situated pair are two compressed, bilobed projections, more or

¹ As in *Sepia*, it is convenient to use the term *oral* for parts towards the mouth end, and *aboral* for those situated towards the opposite extremity, the same terms being also used to indicate *relative* position of different parts. The relative position of the parts is, however, for the sake of simplicity given here as they lie when the mantle-cavity is opened by turning back its thin postero-ventral wall.

less completely united in the middle so as to form a transverse ridge; these are the *aboral osphradia* (*p. os.*). In the middle line of the mantle-cavity is the *anus* (*an.*), a large aperture with minutely lobed margin, situated on a slight elevation, but by no means so prominent as in *Sepia*. On each side are two apertures, the oral

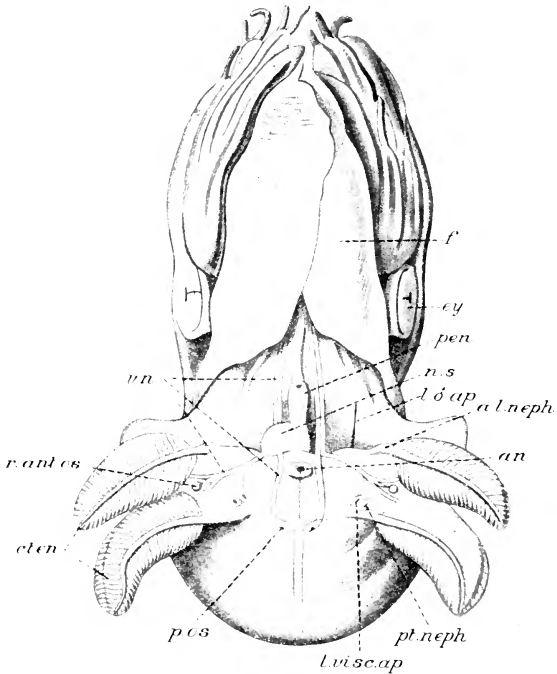

FIG. 689. *Nautilus pompilius*, interior of mantle-cavity, of a male specimen with the postero-ventral wall reflected. *a. l. neph.*, oral left renal aperture; *an.*, anus; *cten.*, ctenidia; *ey.*, eye; *f.*, funnel; *l. 3 ap.*, left reproductive aperture indicated by a bristle passed through it; *l. visc. ap.*, left viscero-pericardial aperture; *n. s.*, Needham's sac; *pen.*, penis; *pt. neph.*, aboral left renal aperture; *p. os.*, aboral osphradia; *r. ant. os.*, right oral osphradium; *r. n.*, visceral nerves. (After Willey.)

and aboral renal apertures (Fig. 689, *a. l. neph.*, *pt. neph.*), corresponding to the single pair of *Sepia*, but not elevated on papillae. Close to each posterior renal aperture is an opening—the *viscero-pericardial* (*l. visc. ap.*, *r. visc. ap.*)—leading into the pericardial section of the cœlome; these are not represented in *Sepia*. In both sexes there are two reproductive ducts, right and left; but

in both the right alone appears to be functional, and the left is much the smaller. The opening of the right sperm-duct of the male is situated on a cylindrical prominence—the *penis* (*pen.*)—placed close to the middle line. In the female the nidamental glands are, as in *Sepia*, conspicuous objects when the mantle-cavity is exposed; but they are mainly situated on its posterior instead of its anterior wall.

Enteric Canal.—The mouth is surrounded by a circular lip beset with numerous papillæ. There is a pair of jaws (Fig. 690, *jaw*) of similar shape to those of *Sepia*, but much more powerful, and calcified towards the tips. The buccal mass is a large rounded body with thick muscular walls. On the floor of the contained cavity is a large and prominent odontophore (*odont.*), with long and pointed, curved teeth. In front of the odontophore is a large bilobed soft prominence, the *tongue* (*tong.*). Behind the odontophore, between it and the opening of the œsophagus, are one large median and two lateral tongue-like prominences beset with papillæ; on the inner surface of the latter are the apertures of a pair of salivary glands.

The œsophagus (*œs.*) becomes dilated aborally into a very spacious *crop* (*cr.*) for the storage of the food, which consists of small prawn-like Crustaceans and small Fishes broken up by the jaws and radula. This opens into a rounded stomach (*stom.*) having very much the appearance of the gizzard-like cæcum of *Sepia*. The intestine (*int.*), shortly after it leaves the stomach, develops a rounded cæcum (*cæc.*) with complexly folded walls, into which the ducts of the digestive gland or “liver” open. The intestine does not pass straight to the anus as in *Sepia*, but first bends round in a short coil. The ink-sac and duct of *Sepia* are not represented. There is a very large digestive gland divided into four main portions or lobes, each of which is made up of a number of lobules. The ducts (“bile-ducts,” *b. du.*), opening as above mentioned into the cæcum, have a series of small diverticula which may represent the pancreatic appendages of *Sepia*.

The **cœlome** consists of the *pericardium* and the *gonocœle*—the cavity in which the gonad is enclosed: these communicate with one another by three apertures. The pericardium contains the ventricle, the four auricles, and parts of the renal glandular appendages. It communicates with the exterior by the visceropericardial apertures.

Heart and Vascular System.—The blood-system consists of the heart, the arteries and veins, and certain large spaces constituting the hæmocœle. The latter consists of three chief parts—the peristomial, peri-œsophageal, and peri-hepatic hæmocœles, the first surrounding the buccal mass, the second the œsophagus, and the third the liver.

The ventricle (Figs. 690 and 692, *vent.*) is a bilobed, transversely

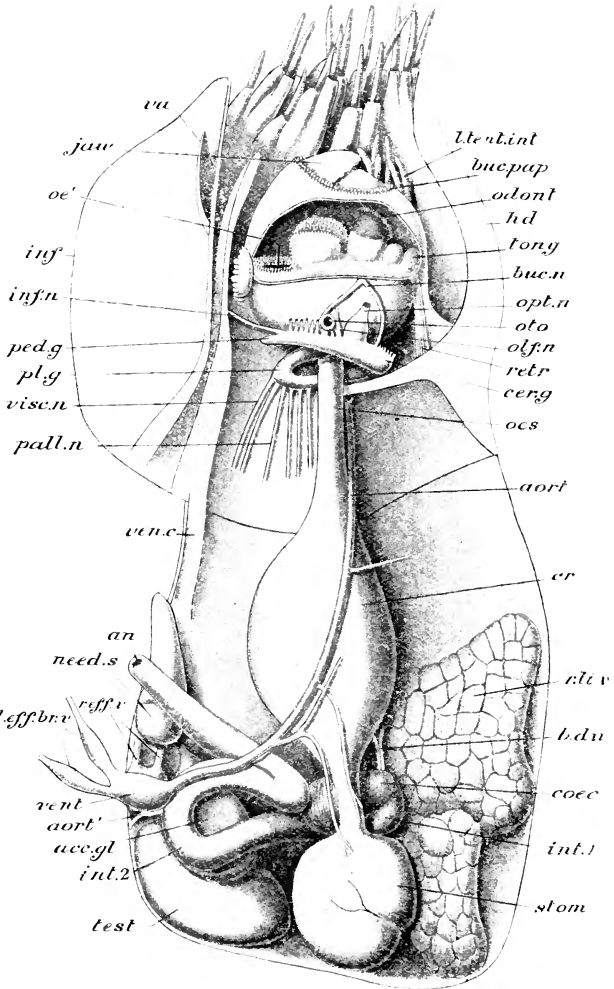

FIG. 690.—**Nautilus pompilius**, dissection of the internal organs of a male, from the left side. The funnel and the hood have been divided by a longitudinal median section. A portion of the wall of the buccal cavity has been removed to show the odontophore and the tongue. *acc. gl.* vesicula seminalis; *an.* anus; *aort.* oral aorta; *aort'* posterior pallial artery; *b. du.* bile-ducts; *buc. n.* buccal nerves; *buc. pap.* papillae of peristomal membrane; *cer. g.* cerebral ganglion; *coec.* caecum; *cr.* crop; *hd.* hood; *inf.* funnel; *inf. n.* infundibular nerve; *int. 1*, part of intestine between stomach and caecum; *int. 2*, part of intestine following caecum; *jaw*, larger (posterior) jaw; *l. eff. br. v.* left efferent branchial vessels; *l. vent. int.* left internal tentacular lobe; *need. s.* Needham's sac; *odont.* odontophore; *ae'* style passed from buccal cavity into the opening of the oesophagus; *as.* oesophagus; *olf. n.* olfactory nerve; *opt. n.* optic nerve; *oto.* statocyst; *pall. n.* pallial nerves; *ped. g.* pedal ganglion; *pl. g.* pleural ganglion; *r. eff. v.* right efferent branchial vessel; *retr.* retractor muscle of the buccal mass; *r. liv.* right lobe of "liver"; *stom.* stomach; *test.* testis; *tong.* tongue-shaped elevation of the floor of the mouth; *va.* valve of funnel; *ven. c.* vena cava; *vent.* ventricle.

placed, muscular sac, very similar to that of *Sepia*. On either side there open into it two *auricles* or *effluent branchial vessels*, one from each of the four ctenidia. The ventricle gives off a large main *aorta* (*aort.*), which passes to the head after giving off arteries to the stomach, the crop, the digestive gland, and the mantle. From the aboral surface of the ventricle arises a smaller artery, the *lesser aorta*, which immediately bifurcates. One of its branches—the *posterior pallial artery* (Fig. 691, *post. pall. a.*)—passes to the area of the mantle applied to the septum, bifurcates to supply this area, and gives off a branch to the siphuncle. The other—*anterior pallial* (*ant. pall. a.*)—after giving off arteries to the intestine and rectum, and to the branchiæ and osphradia, passes to the muscular edge of the mantle, bifurcating anteriorly. Three *genital arteries* (*gen. a. 1, 2, 3*), supplying the various parts of the reproductive apparatus, are likewise given off directly from the ventricle.

A large *vena cava* (Figs. 690 and 692, *ven. c.*) occupies a position corresponding closely with that which it occupies in *Sepia*.

It presents the remarkable peculiarity of being in free communication by numerous (valvular) apertures with the general cavity of the hæmocœle. At its aboral end it presents a dilatation from which four *afferent branchial veins* (Fig. 692, *a. l. aff.*, *p. l. aff.*, *p. r. aff.*, *r. ant. aff.*)—two right and two left—proceed to the corresponding ctenidia, at the bases of which veins from the aboral region join them. There are no branchial veins.

The *renal organs* (Fig. 692) are, like the ctenidia and the afferent and efferent vessels, four in number, instead of two as in *Sepia*. Each renal sac (*l. neph. s.*, *r. neph. s.*, *l. post. neph. s.*, *r. post. neph. s.*) opens into the mantle-cavity, as already stated, by an orifice

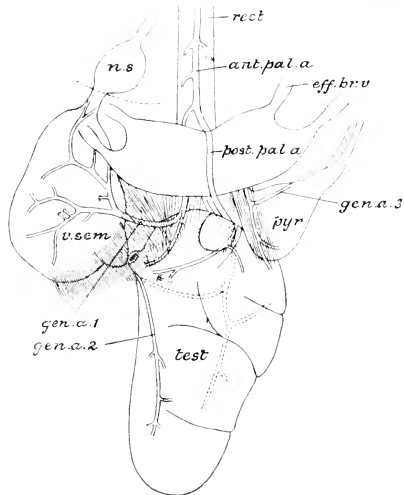

FIG. 691.—*Nautilus pompilius* (male), origin of pallial and genital arteries. *ant. pal. a.*, anterior pallial artery; *eff. br. v.*, efferent branchial veins; *gen. a. 1*, artery to vesicula seminalis (*v. sem.*); *gen. a. 2*, testicular artery and its branches; *gen. a. 3*, artery to pyriform sac; *n. s.*, spermatophore-sac; *post. pall. a.*, posterior pallial artery; *pyr.*, pyriform sac; *rect.*, rectum; *test.*, testis. (After Willey.)

which is not drawn out into a tube. There is no communication between the cavities of the different sacs, and thus no median chamber as in *Sepia*, and there is also no communication with the pericardium. The cavities are found to contain phosphate of lime. Into each projects, from the corresponding afferent branchial vein, a compact rounded group of venous appendages (*ren. app.*), consisting of two symmetrical portions. Internal to these, each afferent vein has connected with it a second group of glandular appendages, which are cylindrical or club-like in form; they project, not into the nephridial sac, but into the pericardial compartment of the cœlome. They have been compared with the appendages of the branchial heart of *Sepia*, but differ in their relations to the renal appendages.

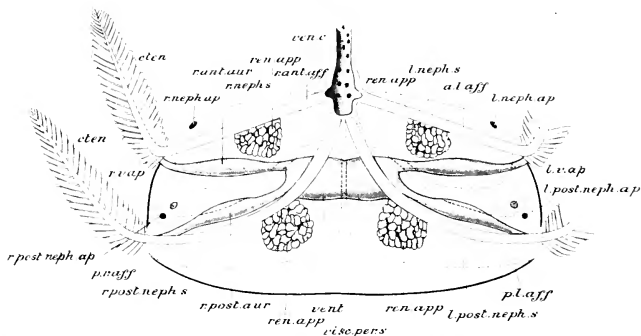

FIG. 692.—*Nautilus pompilius*, renal sacs, with ctenidia and other related parts, as seen from the posterior aspect; the boundaries of the four renal sacs represented by dotted lines. *a. l. aff.* left oral afferent vessel; *cten.* right ctenidia; *l. neph. ap.* left oral renal aperture; *l. neph. s.* left renal sac; *l. post. neph. ap.* left aboral renal aperture; *l. post. neph. s.* left aboral renal sac; *l. v. ap.* left viscero-pericardial aperture; *p. l. aff.* left aboral afferent vessel; *p. r. aff.* right aboral afferent vessel; *r. ant. aff.* right oral afferent vessel; *r. ant. aur.* right oral auricle; *ren. app.* renal appendages; *r. neph. ap.* right renal aperture; *r. neph. s.* right renal sac; *r. post. aur.* right aboral auricle; *r. post. neph. s.* right aboral renal sac; *r. v. ap.* right viscero-pericardial aperture; *vent.* ventricle; *venc.* venous cava; *visc. per. s.* viscero-pericardial sac.

Nervous System.—*Nautilus* differs strikingly from *Sepia*, and somewhat resembles *Chiton* (p. 698, Fig. 614) in the form assumed by the central parts of the nervous system (Fig. 690, *cer. g.*), distinct ganglia being absent. A very thick nerve-collar, the posterior portion of which is double, surrounds the œsophagus. The anterior part of the collar (Fig. 690, *cer. g.*) represents the cerebral ganglia, the oral portion of the posterior part the pedal (*ped. g.*), the aboral portion the pleuro-visceral (*pl. g.*); while the lateral parts, not distinctly marked off from the rest, represent the cerebro-pedal and cerebro-pleural connectives. From the cerebral ganglia pass nerves to the buccal mass, to the olfactory organs (*olf. n.*) and the statocysts, and a pair of very thick optic nerves

supply the eyes (*opt. n.*). The pedal ganglion gives off numerous nerves to the tentacles and the funnel, and from the pleuro-visceral arise pallial and visceral nerves.

Sense Organs.—The *statocysts* (*otocysts*) are a pair of sacs embedded in recesses close to the cerebral ganglia, but not enclosed in the cartilage of the endoskeleton; each contains a number of microscopic *statocones*. An olfactory function is ascribed to a process (the *rhizophore*) with a ciliated pit at its base, situated on the aboral side of the eye. The ophthalmic tentacles (Fig. 685, *o.t.*) are supposed to act as accessory olfactory organs. The *osphradia* contain ganglion-cells, are beset with sensory cilia, and are undoubtedly organs of special sense.

The *eyes*, situated at the sides of the head, are very large but extremely simple in structure, presenting a marked contrast to those of *Sepia*, and scarcely comparable to those of any

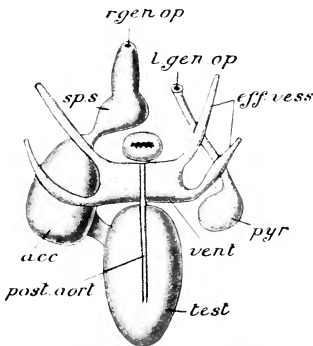

FIG. 693.—*Nautilus pompilius*, male reproductive organs. *acc.* vesicula seminalis; *eff. vess.* efferent branchial vessels; *l. gen. op.* left genital opening; *post. aort.* posterior aorta; *pyr.* pyriform appendage; *r. gen. op.* right genital opening; *sp. s.* spermatophore-sac; *test.* testis; *vent.* ventricle.

other animal with the exception perhaps of *Patella* (p. 726). Each is of the shape of a saucer, attached to the head by its convex side by means of a short thick stalk, the mouth being closed in by a slightly convex disc, with a circular aperture at about its centre. A slightly raised rim runs round close to the margin on the posterior half, and a narrow groove extends inwards from this to the central aperture. In the interior of the cup is neither lens, vitreous humour, nor iris. The sea-water, passing in through the central aperture, directly bathes the retina, which is spread over the interior in a thick layer.

Reproductive Organs.—The gonad (testis, Fig. 693, *test.*, or ovary, Fig. 694, *ov.*), like that of *Sepia*, is single and median, enclosed in a special sac towards the aboral end of the body. The duct is paired in both sexes, but in both the right alone appears to be functional. In the male a large glandular *vesicula seminalis*, in which the spermatophores are formed (*acc.*), is connected with the right duct, and this appears to be represented on the left-hand side by a vestige—the so-called *pyriform sac* (*pyr.*), situated close to the ventricle. The distal part of the right duct dilates to form a receptacle, the *spermatophoral sac* or *Needham's sac* (*sp. s.*), and opens, nearly in the middle line at the end of a prominence—the

penis (Fig. 689, *pen.*). In the female the right oviduct has a glandular dilatation, which is supposed to be an albumen gland. The ova are of large size, greatly exceeding those of *Sepia* in dimensions, containing a large proportion of food-yolk. Nidamental glands are present, but are mainly situated, as already pointed out, on the posterior instead of the anterior wall of the mantle-cavity. Each egg becomes enclosed in an elaborate capsule (Fig. 695), probably moulded by the agency of the organ of Owen, on the inner posterior lobe of the foot of the female (Fig. 686). The development is not known.

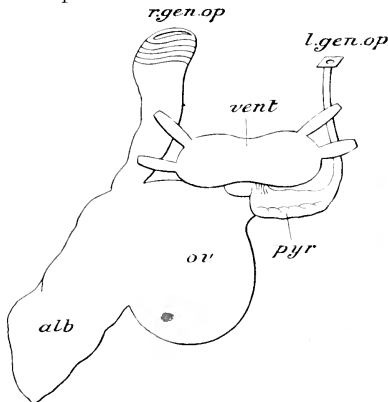

FIG. 694.—*Nautilus pompilius*, female reproductive organs. *alb.* albumen-gland; *l. gen. op.* left genital opening; *ov.* ovary; *pyr.* pyriform appendage; *r. gen. op.* right genital opening; *vent.* ventricle. (After Lankester and Bourne.)

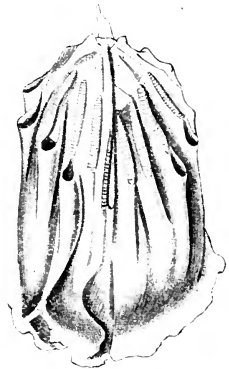

FIG. 695.—Egg of *Nautilus macromphalus*, enclosed in its capsule. (After Willey.)

2. DISTINCTIVE CHARACTERS AND CLASSIFICATION.

The Cephalopoda are bilaterally symmetrical Mollusca, which have the main part of the foot displaced forwards to the neighbourhood of the mouth and divided into a series of arms bearing suckers, or of lobes bearing tentacles, while the remainder of the foot forms a funnel for the egress of water from the mantle-cavity. The visceral mass is symmetrical and not coiled. The mantle encloses posteriorly and ventrally a large mantle-cavity, in which are situated the ctenidia and the renal, reproductive, and anal apertures. The shell may be absent or rudimentary; when present and well developed, it may be internal or external, undivided, or divided internally by septa into a series of chambers. There is an internal cartilaginous skeleton, supporting and protecting the nerve-centres and giving attachment to muscles. The mouth is provided with a pair of horny jaws, and an odontophore is present.

In the majority there is an ink-gland with a duct opening into the rectum. The ctenidia and kidneys are either two or four in number. The nervous system is highly developed; and the principal nerve-ganglia are aggregated together around the œsophagus. The sexes are separate; the segmentation of the ovum is meroblastic, and there is no metamorphosis.

Sub-Class I.—Dibranchiata.

Cephalopoda in which the main part of the foot assumes the character of a cirlet of either eight or ten arms, bearing suckers, and surrounding the mouth. The funnel forms a complete tube. The shell is usually internal; when external its cavity is not divided by septa. There are two ctenidia, two kidneys, and two branchio-cardiac vessels or auricles. An ink-gland and duct are present.

ORDER 1.—DECAPODA.

Dibranchiata possessing ten arms, with stalked suckers provided with horny rims, and with a well-developed internal shell.

This order includes the Cuttle-fishes, Squids, Spirula, and others, as well as the extinct Belemnites.

ORDER 2.—OCTOPODA.

Dibranchiata provided with eight arms, the suckers on which are sessile and devoid of horny rims: with or without slight vestiges of an internal shell. An external shell, secreted by a specially-modified pair of arms, is present in the female Argonaut only.

This order includes the Octopods and the Argonauts.

Sub-Class II.—Tetrabranchiata.

Cephalopoda in which the main part of the foot has the character of lobes bearing numerous tentacles. The funnel does not form a complete tube. There is an external, spiral, chambered shell. There are four ctenidia, four kidneys, and four auricles. An ink-gland is absent.

This sub-class includes only one living genus, *Nautilus*, but the *Ammonites* and other extinct forms are usually referred to it.

Systematic Position of the Examples.

The genus *Sepia* is a member of the family *Sepiidae* of the order Decapoda, which is distinguished from the seven other families of the order by the combination of the following features:—The body is compressed and comparatively broad; the fins are narrow and elongated; the internal shell consists almost entirely of calcareous material.

Nautilus is the sole living representative of the sub-class Tetrabranchiata.

3. GENERAL ORGANISATION.

The uniformity of structure among the Dibranchiate Cephalopoda is very great, and, as already stated, *Nautilus* is the only living member of the Tetrabranchiata, so that comparatively little has to be said to supplement the descriptions of the two examples.

External Features.—The general external shape differs very little in the different members of the Dibranchiata: the body in some is more elongated than in others; the degree of compression likewise varies. Fins may be absent, and the animal may progress entirely by creeping with the aid of the long arms, or by swimming by the movements of the arms, or under the propulsion of a current of water forcibly ejected through the funnel by the contraction of the muscular mantle (Fig. 696). When fins are present they

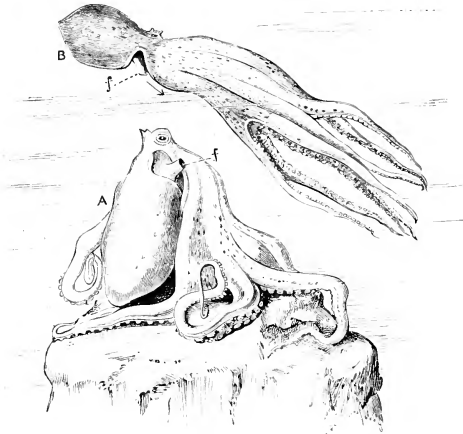

FIG. 696.—*Octopus vulgaris*. A, at rest; B, in motion, f, funnel, the arrow showing the direction of the propelling current through the water. (From Cooke, after Merculiano.)

may take the form of a continuous lateral flap as in *Sepia*, but, more usually, are of the nature of flattened lobes situated towards the aboral extremity of the body (Fig. 697); in *Otenopteryx* they have the character of fringes of filaments. The arms vary in length and proportions and in the form and arrangement of the suckers. Eight arms are present in the Octopoda and ten in the Decapoda. In the former group the Argonauts (Fig. 698) have, in the female, one pair of arms (*wa.*) flattened and expanded at the extremities for the secretion and support of the shell (*sh.*). In the Decapoda one pair of arms, the fourth, is always specially modified, as in *Sepia*, to act as prehensile appendages or *tentacles* usually capable

of being partly or entirely retracted within certain sacs situated at their bases. In nearly all one of the arms in the male is specially modified (or *hectocotylised*) to act as an intromittent organ. This modification is only very slight in *Sepia* and confined to the base, and is most marked in certain of the *Octopoda* (Fig. 699), including the *Argonauts*. In the latter, before the breeding season, the third arm in the male is found to be represented by a rounded sac, which subsequently bursts and sets free the elongated hectocotylised arm. Spermatophores are taken by the arm from the genital opening, and in the act of copulation the entire arm is detached and left in the

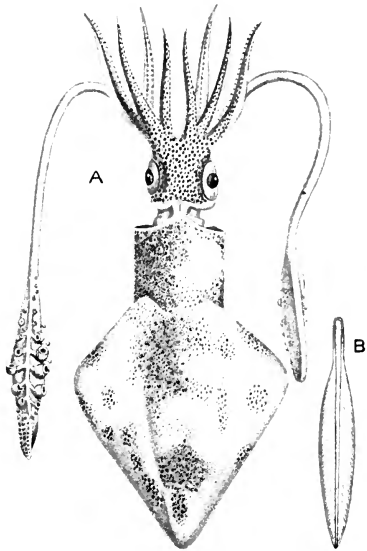

FIG. 697.—*Loligo vulgaris*. A, entire animal, dorsal view; B, horny internal shell or pen. (From Kieferstein.)

mantle-cavity of the female. In other cases the arm is not detached. The suckers are sometimes stalked, sometimes sessile, sometimes armed with hooks, sometimes replaced by hooks. In many cases the arms are united by a web-like fold, the *interbranchial membrane* (Fig. 700) which may reach nearly to their extremities.

In the *Tetrabranchiata* the series of groups of slender,

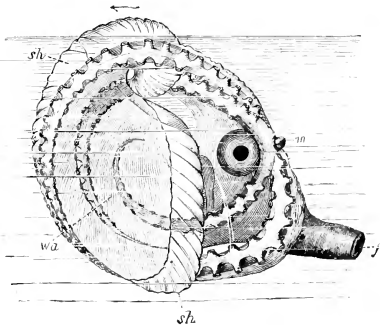

FIG. 698.—*Argonauta argo*, female, showing the relations of the animal to the shell in the living state, the arrow showing the direction of movement. *f*, funnel; *m*, mouth, with jaws projecting; *sh*, shell, with arms as seen through it; *wa*, webbed arm clasp. (From Cooke, after Lacaze-Duthiers.)

ringed, sheathed tentacles, situated on lobes of the foot surrounding the mouth, take the place of the arms, and suckers are not present. In the males the spadix probably represents, functionally at least, the hectocotyliised arm of the Dibranchiata.

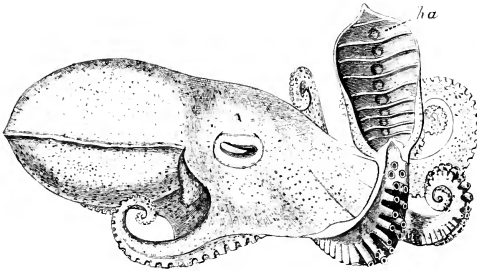

FIG. 699.—*Octopus lentus*, male specimen, showing the structure of the hectocotyliised arm (*h. a.*). (From Cooke, after Verrill.)

In all the Dibranchiata the *funnel* is a complete tube. In the *Nautilus*, on the other hand, as we have seen, the folds which form the funnel have their edges merely in apposition, and not united. A valve, such as has been described in *Sepia*, occurs in most Decapoda and in *Nautilus*, but is absent in the Octopoda. *Chromatophores*, similar to those of *Sepia*, are universal in the Dibranchiata but absent in *Nautilus*.

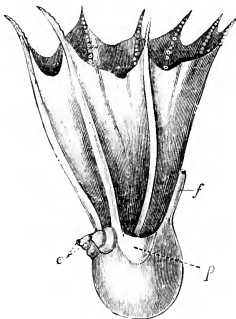

FIG. 700. *Amphitretus pelagicus*, an Octopod with the arms united by a web. *e.* eyes; *f.* funnel; *p.* pouch in the mantle. (From Cooke, after Hoyle.)

Shell.—The shell of *Nautilus* is the most complete and yet in a certain sense the most primitive. As already stated, it is an external shell of a spiral character, divided internally by septa into a series of chambers. The last of the chambers is occupied by the body of the animal; the rest are filled with gas. Perforating the middle of all the septa in succession is a spiral tube—the *siphuncle*—continuous with the centro-dorsal region of the visceral prominence. In the course of its growth the body of the *Nautilus* shifts forward at intervals

into a newly-formed chamber, and a new septum is formed closing the latter off from the cavity last occupied. It is only after the last septum has been formed that the animal attains sexual maturity.

Of existing Dibranchiata, *Spirula* alone has a shell (Fig. 701) comparable to that of *Nautilus*. The shell of *Spirula* is of spiral form, the turns of the spiral, however, not being in contact. Internally it is divided into chambers by a series of septa, and these are perforated by a siphuncle. But the initial chamber (*protoconch*), instead of being, like the initial chamber in *Nautilus*, similar to the others though smaller, is dilated into a spherical shape, constricted off from the succeeding chamber, and has passing through it a tube—the *prosiphon*—not continuous with the siphuncle. Again, as will be seen by comparing Figs. 684 and 702, the relation of the soft parts to the shell is the reverse of what obtains in *Nautilus*, the shell of *Spirula* curving backwards (*endogastric* curvature), that of *Nautilus* forwards (*exogastric* curvature). Moreover the shell of *Spirula* is an internal structure, being almost completely covered by the mantle.

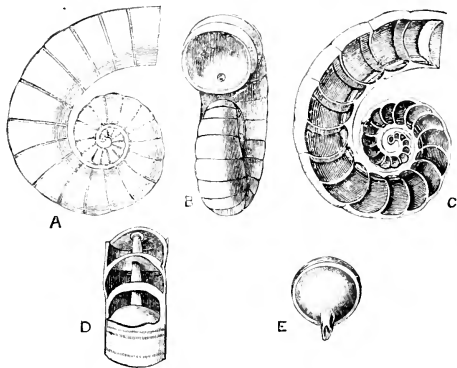

FIG. 701.—Shell of *Spirula*. *A*, outside view; *B*, showing last chamber and position of siphuncle; *C*, in section, showing the septa and the course of the siphuncle; *D*, shell broken to show the convexity of the inner side of the septa; *E*, portion of a septal neck. (After Cooke.)

The shell of the extinct *Ammonites* (Fig. 703), which are usually referred to the Tetrabranchiata, resembles that of the *Nautilus* in many respects, being a chambered spiral shell with a large terminal chamber, and with a siphuncle. The chief external difference is in the form of the *sutures*, or lines of union of the edges of the septa with the side wall of the shell; these are more or less complexly lobed, instead of being entire as in *Nautilus*. But in one important respect the shell of an

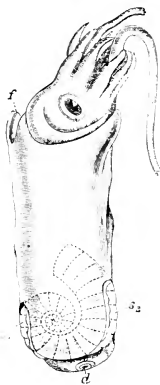

FIG. 702.—*Spirula peronii*, lateral view. *d*, terminal sucker; *f*, funnel; *s*₁, *s*₂, projecting portions of the shell, the internal part of which is indicated by dotted lines. (From Cooke.)

The shell of the extinct *Ammonites* (Fig. 703), which are usually referred to the Tetrabranchiata, resembles that of the *Nautilus* in many respects, being a chambered spiral shell with a large terminal chamber, and with a siphuncle. The chief external difference is in the form of the *sutures*, or lines of union of the edges of the septa with the side wall of the shell; these are more or less complexly lobed, instead of being entire as in *Nautilus*. But in one important respect the shell of an

Ammonite differs from that of *Nautilus* and approaches that of the dibranchiate *Spirula*. At the apex of the spiral is an initial chamber or protoconch, which is dilated and separated from the first of the ordinary chambers by a constriction, and has passing into it a prosiphon not continuous with the siphuncle. The

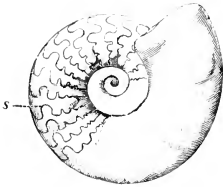

FIG. 703.—An **Ammonite** (*Ceratites nodosus*). *s.* lobed sutures.

Ammonite was also characterised by the possession of a paired or unpaired calcified structure, called the *aptychus*, not represented in any existing form. The *aptychus* was most probably endoskeletal. Young Ammonites, each with its *aptychus*, have been found within the shell of the parent, in which they must have remained protected during their development.

In the ordinary decapod Dibranchiata the shell may consist of three parts—a horny *pen* or *pro-ostracum*, a calcareous *guard*, and a part termed the *phragmacone*. The last, which alone represents the shell of *Spirula*, has the form of a cone divided internally by a series of septa perforated by a siphuncle. These parts are most completely developed in the extinct genus *Belemnites*, in which the shell (Fig. 704) consists of a straight, conical, chambered *phragmacone* (*phr.*), with a siphuncle, enclosed in a calcareous sheath, the *guard*, produced into a horny or calcareous plate, the *pro-ostracum* (*pen.*). In *Sepia* the spine-like projecting point represents the *guard*, and the main substance of the shell is to be looked upon as the *pro-ostracum* and *phragmacone*. In the *Squids* (e.g., *Loligo*) the shell (Fig. 697, *B*) is long, narrow, and completely horny; it corresponds to the *pro-ostracum*, the *phragmacone* being entirely absent.

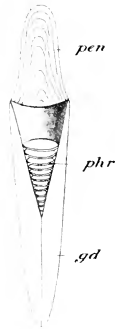

FIG. 704.—Shell of a **Belemnite**. *gd.* guard; *pen.* pro-ostracum; *phr.* phragmacone. (From Nicholson and Lydekker's *Palaontology*.)

In *Octopus* the shell is represented only by a pair of vestiges with which muscles are connected. In *Argonauta* there is no shell in the male, but the female has an external shell (Fig. 705) of a remarkable character. This is a delicate spiral structure the internal cavity of which is not divided into chambers. It is not secreted by the mantle like the shells of other Mollusca, but by the surfaces of a pair of the arms ending in expanded disc-like extremities, which become applied to its outer surface (Fig. 698); its chief function is to carry the eggs.

An **internal cartilaginous skeleton** is present not only in

Sepia and *Nautilus*, as already described, but in all the Cephalopoda. Such an internal skeleton occurs in other groups—some Chaetopoda (p. 462), Crustacea, and Arachnida (p. 651)—but attains a much more elaborate character in the present group than in any other Invertebrates.

The plume-shaped **gills**, lodged in the mantle-cavity, are two in number in all the Dibranchiata, as in *Sepia*. In the Tetrabranchiata there are four gills, similar in general character to those of the Dibranchiata.

The **cœlome** in the Dibranchiata has the extent already indicated in the case of *Sepia*, except that in the Octopoda the oral part does not exist. In *Nautilus* it encloses, besides the heart and gonad, a part of the glandular appendages of the afferent branchial vessels. In the Dibranchiata the pericardial portion communicates with the renal sacs; in *Nautilus* this communication is absent, but the cœlome opens on the exterior by two symmetrical visceropericardial orifices placed at the side of the openings of the aboral kidneys.

Alimentary Organs.—Jaws similar to those of *Sepia* are present in all the members of the class; in *Nautilus*, instead of being completely horny, they are partly calcified.

Buccal mass, œsophagus, stomach, intestine, salivary glands, and digestive gland are all of the same general character throughout all the members of the class. In some of the Dibranchiata, such as *Octopus*, there are two pairs of salivary glands. In *Nautilus* the salivary glands are absent, so far as known, the œsophagus is dilated to form a sort of crop, and the stomach is gizzard-like. In that genus also the ink-gland, general in the Dibranchiata, is absent, and there is a cœcal appendage to the intestine; the digestive gland is four-lobed, each lobe having its duct. The so-called pancreas, described in *Sepia*, is similarly developed in all the Dibranchiata, and is present also, though only feebly developed, in the Tetrabranchiata.

Heart and vascular system are well developed in the Cephalopoda, and their structure and arrangement closely correspond with what has been described in *Sepia*, except that in

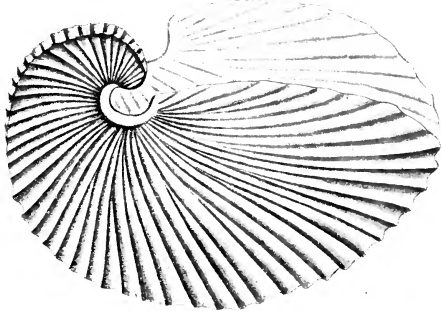

FIG. 705.—Shell of *Argonauta argo*.

Tetrabranchiata there are, as already stated, in accordance with the double number of gills, four auricles instead of two, and branchial hearts are absent.

Nervous system and Sense-organs.—The ganglia of the central nervous system are in all closely aggregated together round the œsophagus, as already stated to be the case in *Sepia*; and the general disposition is the same as that described. In *Octopus* the ganglia are much less sharply marked off. In *Nautilus*, as already mentioned, there is less concentration, and distinct ganglia are not recognisable. All the Dibranchiata possess highly developed *eyes* similar to those of *Sepia*, elevated on stalks in certain cases; but in *Nautilus* the eyes are of a much simpler character, each consisting of a sac opening on the exterior by a small rounded aperture, lined internally by a two-layered retina similar to that of *Sepia*, but without lens, vitreous humour, or cornea. In the embryo of the Dibranchiata, the eye passes through a stage in which it is in the condition of an open cup similar to the adult eye of *Nautilus*. *Osphradia* are present, as already mentioned, only in the Tetrabranchiata; but in both the Dibranchiata and the Tetrabranchiata

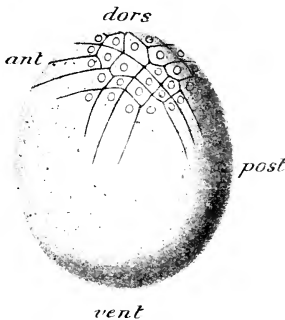

FIG. 706.—Segmenting ovum of *Loligo*.
(From Korschelt and Heider, after Watasé.)

certain sensory processes or depressions conjectured to possess an olfactory function are developed on the head. *Statocysts* are universally present.

All the Dibranchiata have two **kidneys** or **renal sacs** similar in character to those of *Sepia*, and communicating with one another; in *Octopus* they are completely united. In the Tetrabranchiata there are four kidneys, each opening on the exterior.

The **sexes** are distinct in all the Cephalopoda, and in addition to the hectocotyliised arm there are frequently other external differences between male and female. In all the Dibranchiata the arrangement of the gonads and gonoducts is, as regards general features, similar to what we find in *Sepia*. In *Octopus*, however, there are two oviducts instead of one, and in one other member of the Octopoda (*Eledone moschata*) the same holds good of the spermiducts.

Development.—The development of the Dibranchiata alone is known. The eggs are very large, containing a relatively large amount of food-yolk. They are usually laid in masses or strings embedded in a soft, gelatinous, or a tougher, more leathery substance, usually attached to some foreign body; in some cases

each egg, enclosed in a gelatinous sheath, has a longer or shorter stalk. A *chorion* or delicate transparent egg-membrane, in which

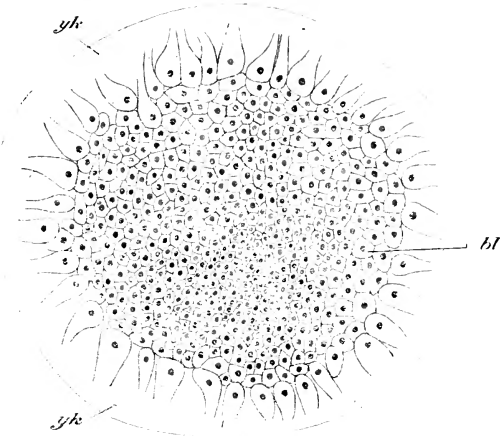

FIG. 707.—**Sepia**, blastoderm at a late stage of segmentation. *bl*, blastoderm; *yk*, yolk. (From Korschelt and Heider, after Vialleton.)

there is an aperture—the *micropyle*—immediately invests the egg itself. In shape the egg is oval or spherical. The greater part

of the comparatively small quantity of protoplasm lies as a disc-like elevation on the surface of the yolk on the side of the egg at which the micropyle is situated. Continuous with this *germinal disc* is a thin layer of peripheral protoplasm investing the entire ovum.

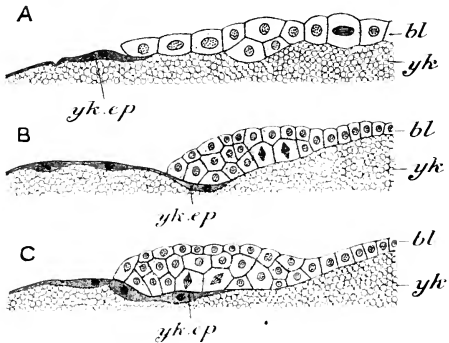

FIG. 708.—Sections through the edge of the blastoderm of **Sepia** at three successive stages. *bl*, blastoderm; *yk*, yolk; *yk.ep*, yolk-epithelium. (From Korschelt and Heider, after Vialleton.)

Segmentation (Figs. 706 and 707) is incomplete, being confined

to the germinal disc. At an early stage in the process of division the blastoderm exhibits a distinct bilateral symmetry. This meroblastic segmentation results in the formation of a nearly circular blastoderm, the outer cells of which tend to separate off. At first the blastoderm consists of only a single layer of cells—the ectoderm, which gradually extends. At a later stage a second layer (Fig. 708, *B, C*) appears below the margin of the blastoderm,

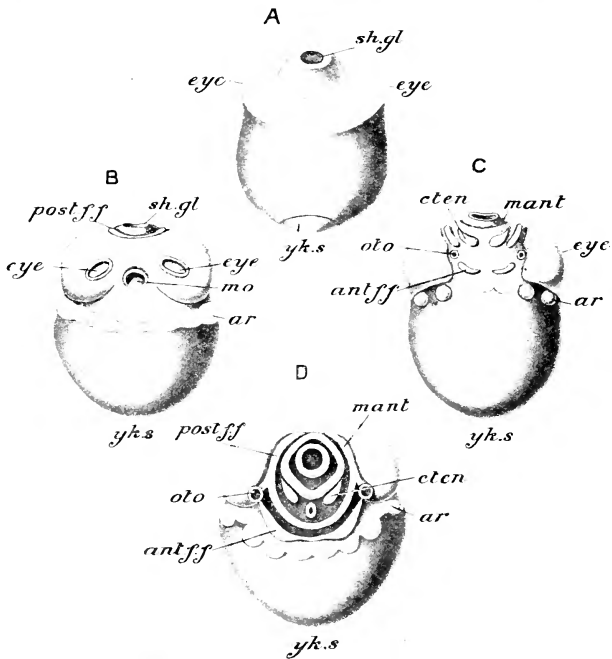

FIG. 709.—Early stages in the development of *Loligo*. *A*, stage at which the rudiments of the eyes and of the shell-gland are first distinguishable; *B*, later embryo from the oral side; *C* and *D*, from the anal side. *ant. f. f.*, anterior tunnel fold; *ar.*, rudiments of arms; *cten.*, ctenidia; *eye*, eye; *mo.*, mouth; *mant.*, rudiment of mantle; *oto.*, statocyst; *post. f. f.*, posterior tunnel fold; *sh. gl.*, shell-gland; *yk. s.*, yolk-sac. (After Korschelt and Heider.)

and extends inwards until it comes to underlie the greater part of the embryonic part of the blastoderm: separating this from the yolk is a thin layer of uncertain derivation—the *yolk-epithelium* (Fig. 708, *yk. ep.*). There is some doubt as to the nature of the second layer: it certainly gives rise to the mesodermal structures, and by some observers it is also said to form the epithelium of the

mesenteron. From whatever source it may be derived, the latter becomes distinguishable as a cell-plate which becomes converted

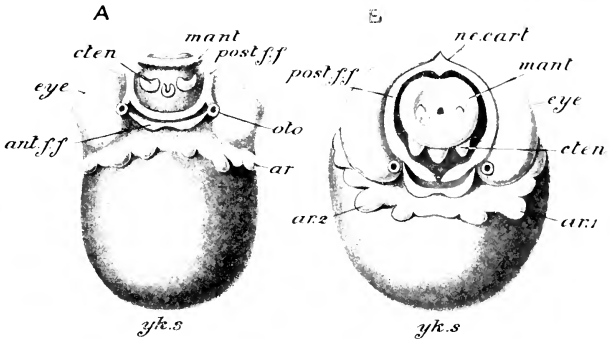

FIG. 710.—Two later stages in the development of *Loligo*. *A*, from the funnel side; *B*, obliquely from above. Letters as in preceding figures; *nc. cart.* nuchal cartilage. (After Korschelt and Heider.)

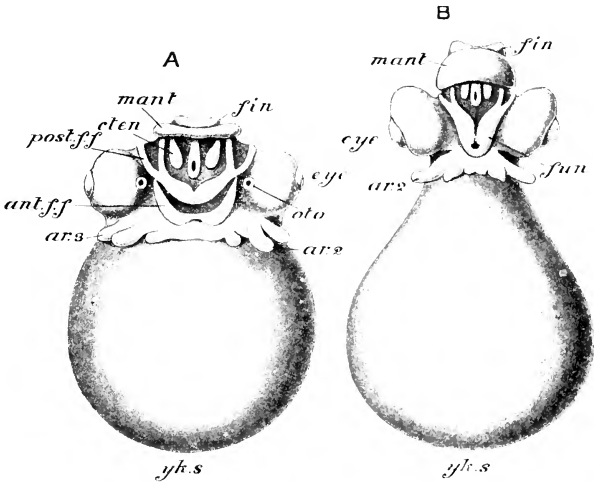

FIG. 711.—Two stages in the development of *Loligo*, later than those represented in Fig. 710. From the anal or funnel side. Letters as in preceding figure; in addition, *fun*, fins; *fun.* funnel. (After Korschelt and Heider.)

into a vesicle at first opening below against the yolk epithelium, there never being any direct communication with the yolk. An

extensive stomodæum eventually opens into this; a proctodæum is merely represented by the ectodermal pit forming the anus.

About the middle of the blastoderm appears a thickening of a cap-like shape, the edges of which become raised above the general level of the blastoderm; this is the rudiment of the mantle. On the surface of this is developed a depression which subsequently forms a closed sac—the *shell-gland* (Fig. 709, *sh.gl.*). Below the mantle—*i.e.* nearer the vegetal pole—appear two elevations, each with a pit-like depression, which are the rudiments of the eyes; and still nearer the vegetal pole a series of paired elevations, the rudiments of the arms.

After the complete enclosure of the volk by the blastoderm, the mouth (*mo.*) is developed as an oval depression between the rudi-

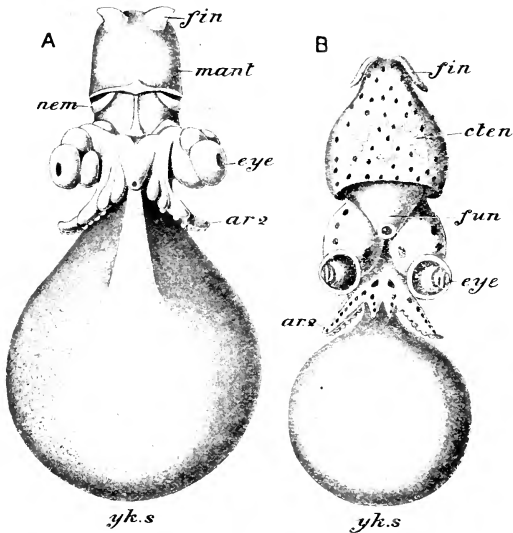

FIG. 712.—Two late stages in the development of *Loligo*, seen from the funnel side. Letters as in preceding figures. (After Korschelt and Heider.)

ments of the eyes. Immediately in front of the edge of the mantle appear two short ridges, the beginnings of the gills (*cten.*), and a pair of folds—the *posterior funnel-folds* (*post. f. f.*)—which are formed between these and the eyes, are the first rudiments of the funnel; the greater part of which, however, is formed from a second pair of folds—the *anterior funnel-folds* (*ant. f. f.*)—developed further

forwards. Behind the anterior funnel-folds appear two pit-like depressions, which subsequently develop into the statocysts.

The elevations on which the eyes (*eye*) are situated become more and more prominent. The eyes themselves are formed from a part only of these elevations; each is a pit which subsequently becomes closed to form a vesicle—the *optic vesicle*: later an ingrowth of the ectoderm over this gives rise to the lens.

The embryo covers only a part of the egg, and as it develops, it withdraws itself more towards the animal pole, at which the germinal disc was originally situated—a constriction, which soon becomes very deep, separating it off from the rest of the egg; the latter, consisting of the greater part of the yolk enclosed in a thin layer of blastoderm, forms a rounded appendage of the embryo—the *yolk-sac* (*yk. s.*). The yolk-sac undergoes contractions, which are due to the action of contractile cells in the thin mesoderm lining it, and by this means the yolk is forced into the interior of the body of the embryo.

The anus appears as an aperture situated on a little papilla—the *anal papilla*. A row of cilia, which are developed in the neighbourhood of the mouth in some forms, perhaps represent the velum or pre-oral circlet of other molluscan embryos. The mantle now increases in extent, and its margins become more prominent. The anterior funnel-folds grow out and unite in the middle line; and these, with the posterior folds, go to form the completed funnel together with the “neck-muscles.” For a time the edges of the two folds which form the funnel remain free; eventually they coalesce into a complete tube.

The edges of the mantle grow out into prominent folds to form the mantle-cavity, into which the gills are drawn. Lateral out-growths have already given rise to the rudiments of the fins. The arms grow out into more and more prominent processes on which the suckers are developed, the fourth pair—the prehensile arms (*ar. ?*)—soon becoming distinguishable from the rest by their greater length.

As the embryo increases in size, the yolk is gradually absorbed, and the yolk-sac decreases in bulk, until, when the embryo leaves the egg, it has almost completely disappeared.

Distribution.—The Cephalopoda are all marine, and range from tidal limits to a considerable depth. A large number (*Loligo*, &c.) are pelagic and move together in great shoals. *Sepia* lives chiefly between stones and in rock-fissures in the littoral zone, and often burrows in sand. *Octopus* constructs a den or shelter of stones to which it always returns after excursions in search of food. Cephalopods are, nearly without exception, carnivorous. In length they range from an inch or two to as much as fifty feet—the gigantic members of the group, such as *Architeuthis*, being by a long way

the largest of invertebrate animals. Like the other classes of Mollusca they are most abundant in tropical and warm-temperate seas.

If the Ammonites are to be included among the Tetrabranchiata, that sub-class was most abundantly represented during the Mesozoic period. The nautiloid Tetrabranchiata were most abundant in the Palæozoic epoch, during which there lived a great variety of forms of this group, the shell being straight (*Orthoceras*), or curved (*Phragmoceras*), or in a flat spiral with the turns not in contact, or in a helix, or a flat close spiral (*Nautilus* and others). The earliest representatives of the Nautiloids are found in rocks of Cambrian age; they are comparatively scarce in the Mesozoic epoch and in the Tertiary, and are represented at the present day only by the genus *Nautilus* itself. The Ammonites are mainly Mesozoic, the representatives found in the earlier rocks (from the Upper Silurian onwards) being few in number and simpler in structure than the more typical later forms. The oldest fossil representatives of undoubted Dibranchiata belong to the extinct order of the Belemnites, which flourished in the Mesozoic period from the Trias to the Cretaceous, and survived in scanty number into the Tertiary. Unlike the Tetrabranchiata, the Dibranchiata would appear to have reached their maximum at the present day.

The mutual relationship of the various groups of Cephalopoda are indicated, as nearly as the information at our disposal will allow, in the following diagram (Fig. 713).

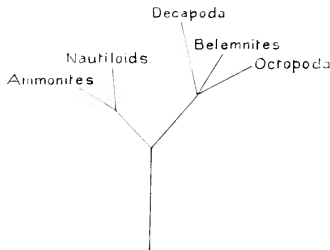

FIG. 713.—Diagram to illustrate the relationships of the groups of **Cephalopoda**.

GENERAL REMARKS ON THE MOLLUSCA.

The Mollusca, like the Arthropoda, form an extremely well-defined phylum, none of the adult members of which approaches the lower groups of animals in any marked degree. There are, however, clear indications of affinity with "Worms," especially in the frequent occurrence of a trochophore stage in development, and in the occurrence, in Amphineura and some of the lower Gastro-

poda, of a ladder-like nervous system resembling that of some Turbellaria and of the most worm-like of Arthropods—Peripatus. The head-kidneys or primitive nephridia of the molluscan and annelid trochophore are very similar, though developmentally unlike, and are probably homologous with certain types of nephridial tubes found in "Worms" from Platyhelminthes to Chaetopoda.

If the occurrence of the trochophore be taken as a guide towards the ancestry of the Mollusca, it need not necessarily be regarded as leading back to the Annulata. In fact the absence of segmental repetition of parts in all, with the exception of Nautilus, would seem to indicate the derivation of the phylum from a group in which metamerism had not arisen. It will be readily recognised that the gap between the typical trochophore and certain forms of Turbellarian larvæ (Müller's larva) is not a very wide one, and might be covered by adaptation of the larval Flat-worm to a freer pelagic life. If we were to suppose that the most primitive Mollusca were derived from Turbellarian-like ancestors, the conversion of a larva of the type of Müller's larva into a larval form like the molluscan trochophore would also have to be postulated. This might involve a common platyhelminth origin for Annulata and Mollusca, with subsequent extreme divergence—a divergence in which the respective trochophores would take part, though in a limited degree. The chief changes which the adult animal would have to undergo in order to assume the character of a primitive Mollusc on this supposition would be—(1) the development of some kind of protective layer of hard material, perhaps composed at first of spicules in a thickened integument, on the dorsal surface—the rudiment of the shell; (2) the greater development of the muscular layers of the body-wall on the ventral side to give rise to a more efficient and specialised creeping organ than was possessed by the Turbellarian ancestor; (3) the development of specialised respiratory organs in the form of ctenidia—a change rendered necessary by the great reduction in the available respiratory area brought about by the development of the shell; (4) the formation of an anus and proctodæum; and (5) the development of a cœlome.

With regard to the relationships of the various classes of Mollusca, the following points are some of the most important to be borne in mind.

The simplest, but not necessarily the most primitive, members of the phylum are undoubtedly the Protobranchia among Pelecypoda, and the Aplacophora among Amphineura. The latter take the lowest rank in virtue of the absence of both foot and shell, but the possession by some of a radula indicates a comparatively high degree of specialisation. On the other hand, while there is no indication of an odontophore, even in a rudimentary condition, in the Pelecypoda, the foot and shell are well developed even in *Nucula* and its allies. There is no actual evidence to show that the foot

and shell have been lost by degeneration in the Aplacophora or the odontophore in Pelecypoda ; and it would appear, therefore, that the two groups are to be derived independently from some primitive form.

The facts that the pelecypod shell, at its first appearance, is univalve, and that the foot of the Protobranchia is of the creeping type and their ctenidia plume-like, suggest the derivation of the class from a form resembling a simple type of Gastropod with no odontophore and with undisturbed bilateral symmetry. The Amphineura are also bilaterally symmetrical, with paired ctenidia, kidneys, and auricles ; and the fact that these organs are also paired in the lower Gastropoda seems to point to a common ancestor for Pelecypoda, Amphineura, and Gastropoda, which was bilaterally symmetrical, had a creeping foot, a simple shell, paired auricles, kidneys, and gills, and no odontophore.

While the leading feature in the evolution of the Pelecypoda has been the splitting of the mantle into two halves and the resulting bivalve shell, the most noticeable fact in that of Gastropoda, apart from the appearance of the odontophore, has been the torsion of the visceral mass, producing a characteristic asymmetry. In the Cephalopoda, on the other hand, the primitive bilateral symmetry is retained, and the most characteristic special feature of the group is the extraordinary modification of the foot into arms or tentacles, and funnel. The class is raised far above the remaining Mollusca by its wonderfully high organisation, especially of the nervous system and the eye, and there is nothing to indicate close relationship with any of the lower classes beyond the general conformity to the molluscan plan of organisation and the presence of an odontophore. The Cephalopods form, in fact, a singularly isolated group. Palæontology has not hitherto given any indication of their origin, and embryology is equally silent ; the absence of a free larva, and the profound modification in development produced by the enormous mass of food-yolk, sharply separating them from all other members of the phylum.

INDEX

INDEX

All numbers refer to pages : words in italics are names of families, genera and species : words in thick type are names of higher divisions : words in small capitals are names of examples. Numbers in thick type are numbers of pages on which there are figures : an asterisk after a number indicates a definition of the term or of the group.

A

- A**BACTINAL, 368*, 410
 Abdomen, of *Apus*, 519 : *Astacus*, 528 : *Periplaneta*, 603, 606
 Aboral, 368*, 410
 Absorption, 33
 Abyssal species, 3*
Acantharia, 62, 63, 65
Acanthin, 63*
Acanthobdella, 505, 506
Acanthocephala, 293* : External characters, 307, 308 : Body-wall, 307 : Body-cavity, 307, 333 : Proboscis, 308 : Vessels, 308 : Nervous system, 308 : Excretory organs, 308, 309 : Reproductive organs, 309 : Development, 309, 310
Acanthohammingia, 482
Acanthometridae, 62
Acarida, 646, 649, 651, 652, 653, 655, 656
 Accessory female glands, 240*, 265*
 Achromatin, 19*
 Aciculum, 431*
Acineta, 101, 102, 103
Acæla, 248, 261, 266, 267
Acontia, 186*, 199, 206
 Acorn-shells, 551
Actæon, 726
 Actinal, 368*, 410
Actinia, 191, 225
Actiniaria, 192*, 194, 195
Actinobolus, 95, 96
Actinodactylella, 253, 256, 260, 268
Actinometra, 416
Actinomma asteracanthion, 63, 64
Actinophrys sol, 58, 59, 61
Actinosphaerium, 58, 59, 61
 Actinostome, 369*
Actinotrocha, 351, 352, 512
Actinozoa, 129 : Example, 183 : Distinctive characters and classification, 191 : Systematic position of example, 194 : General organisation, 194 : Budding, 195 : Structure of polypes, 196 : Enteric system, 199 : Fixed and free forms, 199 : Dimorphism, 200 : Skeleton, 200 : Colour, 205 : Commensalism, 205 : Distribution, 207
Actinula, 223*, 227
Adamsia palliata, 205, 206
 Adductor impressions, 665, 666, 679, 680, 681
 Adductor muscles, 357*, 666, 675, 676, 677, 679, 680
 Adhesive cells, of *Horimiphora*, 213*
 Turbellaria, 258
Adinidae, 81
 Adipose tissue, 27*, 28
 Adjustors, 357*
 Adradius, 139
 Adrectal gland, 724
Æginopsis, 156
Æginura, 155
Æquorea, 143
 Affinities—See Relationships
Agalmæ, 163
 Agamobium, 141*, 175
 Aggressive characters, in Crustacea, 586
 Air-sacs, of Insects, 627, 628
Albertia, 328
Alciopidae, 477
Alcippe, 551, 565
Alcyonacea, 193*, 195, 197, 200
Alcyonaria, 193*, 194, 195, 197, 199, 200, 224

- Alcyonidæ*, 205
Alcyonidium, 340
Alcyonium, 193, **200**
 Alecithal egg, 217*
Alyæ, 65
 Alimentary canal—See Digestive system
 Alimentary system—See Digestive system
Allobobophora antipæ, 469
Alpheus, 587
 Alpine forms, 8*
 Alternation of generations—See Metagenesis
 Alveolus, of Sea-urchin, 389*
 Ambulacral area, 389
 Ambulacral grooves, 369*
 Ambulacral ossicles, 371, 373, **374**, 410
 Ambulacral pores, 371, 389
 Ambulacral ridges, 373
 Ambulacral spines, 369, 380
 Ambulacral system, of *Asterias*, 375 :
Echinus, 389, **391**: Sea-cucumber, 394, **395**: *Antedon*, 399: Echinodermata, 407
 Amitotic division, 20*
 Ammonites, 767, **772**, 780
 Amnion, of *Periplaneta*, 613* : Scorpion, 644
 AMŒBA, 10, 11, 12, 13, **14**, 15, 46 : Pseudopods, 46, **47** : Endosarc, 46 : Ectosarc, 46 : Contractile vacuole, 46, **47** : Encystation, 46 : Fission, 46 : Systematic position, 48
Amœba coli, 51
Amœba histolytica, 51
Amœbidæ, 48
 Amœbocytes, 374, 392
 Amœboid cells, 25
Amœbophyra, 231
 Amœbula, of *Didymium*, **68**, 69 : of *Gregarina*, **84**, 86
 Amphiblastula, 124*, 125, **126**
 Amphidises, 122*, **123**
Amphilina, 256, 283
Amphineura, 663, 694* : Distinctive characters and classification, 694 : General organisation, 695 : External features, **695**, **696** : Ctenidia, 695 : Alimentary system, 696, **697** : Body-cavity, **697** : Vascular system, 698 : Nervous system, **698** : Reproductive and renal organs, **699**, **700** : Development, **700**, **701** : Ethology, distribution, &c., 701, 702
Amphinomida, 457
Amphipoda, 554*, 569, 570, **571**, 572, **573**, 578, 580, 581, 587
Amphiptyches, 256, **258**
Amphistomum, **253**
Amphitretus pelagicus, **770**
Amphinra, 229
Amphiura squamata, 420
 Ampullæ, 159*, 371*, 391, 394
Ampullaria, **730**
Amusium, **685**, 686
 Anal filament, 648
 Anal glands, of *Peripatus*, 594
 Anal respiration, 581
 Anal spot, of *Paramœcium*, 92
 Anal vesicles, 480*
Anaspidacea, 552*, **567**, 581, 587
Anaspides, 553
 Anatomy, 3*
 Anchors, 176
Anquillula, 299
Anisopoda, 569*
Annulata, 430* : General remarks on, 510 : Relationships, 512, 513
 Annuli of Leech, 494
 ANODONTA, 663 : Shell, 664, **665**, **666** : Body, 666, **667** : Muscles, 667 : Cœlome, 667, 668 : Digestive organs, **668** : Gills, **669** : Excretory organs, 671, 672 : Circulatory system, **672**, 673 : Nervous system, 673 : Sensory organs, **673**, 674 : Reproductive organs, 674 : Development, **674**, **675**, **676** : Systematic position, 678, 679
Anodonta cygnea, 663, **664**, **665**, **667**, **668**, **669**, **670**
Anomia, 678, 680
Anomura, 555*, **574**, 575
Anopheles, 89
Anoplophyra, **96**
Anoplura, 619
Anostraca, 549*, 557
 ANTEDON ROSACEA, 396, **397** : General external features, 396, **397** : Ossicles, 398 : Cœlome, 398 : Enteric canal, 399 : Ambulacral system, 399 : Nervous system, 400 : Perihæmal and hæmal system, 400 : Sacculi, 400 : Reproductive organs, 401 : Metamorphosis, 401, **423**, **424** : Systematic position, 406 : Development, **423**, **424**
 Antenna, of *Astacus*, 531—See also Appendages
 Antennary gland, of *Astacus*, **538**, 539
 Antennary glands, **538**, 581
 Antennule, of *Astacus*, 531—See also Appendages
 ANTHENEA FLAVESCENS, **376**, **378**, **379**, 380
Anthomedusæ, 142*, 144, 145, 149
Anthosoma, **561**, 562
Anthura, 554
 Antimeres, 43*, 406
Antipatharia, 193*, **198**, **199**, 201, 207
Antipathes, **198**
 Antispadix, 759
 Ant-lions, 618
 Ants, 621, **636**, 637
 Aorta—See Vascular system

- Aphides*, 632
Aphis rosæ, **618**
Aphrodite, **464**
Aphroditæ, 463, 464
 Apical plate, of Trochosphere, 316 : of
 Articulata, 363*
 Apical system of plates, **385, 389**
Apis mellifica, **622, 631, 636**
Aplacophora, 694*, 695, 696, 697, 698,
 699, 700, 702, 781
Aplysia, 718, 719, **720, 726**
Aplysiidæ, 714
Apoda (Holothuroidea), 404*, 417, 419
Apodidæ, 555, 556
 Apople, **109, 110, 111***
 Appendages, of Rotifera, 323 : *Apus*,
 517, 518 : *Astacus*, **529, 530** : Crus-
 tacea, 556 : *Peripatus*, **591** : *Peri-*
 planeta, **605, 606, 607** : Insecta, 623 :
 Scorpion, 639, 640
Apsuedes, 553
Apterygota, 615*, 661
Aptychus, 772*
APUS, 514 : External characters, **515,**
516 : Appendages, **517, 518** : Body-
 wall, 519 : Muscular system, 519 :
 Digestive organs, 520, 521 : Body-
 cavity, 521 : Circulatory system,
 521 : Respiration, 522 : Renal
 organ, **522** : Nervous system, 522,
 523 : Organs of sense, 523, **524** : Re-
 productive organs, 524 : Develop-
 ment, **525** : Systematic position, 555
Apus, **518, 521, 522, 524, 525**
Apus cancriformis, **515, 523**
Apus glacialis, **517**
 Aquatic pupa, 635
Arachnida, 515, 637*, 659, 661, 661,
 662 : Example, 638 : Distinctive
 characters and classification, 644 :
 General organisation, **646** : External
 form, **646-651** : Endosternite, 651 :
 Coxal glands, 651 : Alimentary sys-
 tem, 651 : Heart, 652 : Organs of
 respiration, 652 : Nervous system,
 653 : Sense organs, 653 : Repro-
 ductive apparatus, 654 : Mode of
 life, 655 : Geological history, 656 :
 Appendix, 657
Arachnidium, 649
Araneida, 645*, **648, 651, 653, 656**
Arbacia punctulata, pedicellaria, **413**
Arca, 678, 679, 683, **685, 686, 688, 690,**
 693
Arcella, **49**
Archæocyathinæ, 126
 Archæocytes, 123
 Archenteron, 24*
Archi-Annelida, 428, **491*, 492, 493,**
 511, 513
 Archi-cerebrum, 542 : of *Feriplaneta*,
 615
Archi-Chætopoda, 454*, 465
Archidoris, 719
Archigetes, 256, **258, 283**
Architeuthis, 779
Argiope, 359
Argonauta argo, **769, 772**
 Argonauts, 767, 768, 769, 772
Argulus, 551, **562, 563**
Arhynchobdellida, 504*
 Aristotle's lantern, 389*
 Ark-shell, 686
Armadillidium, **572**
 Arrow worms, 292
Artemia, 549, 557
 Arthrobranchiæ, 538
Arthropoda, 514* : Affinities of air
 breathing, 661, 662
Arthrostraca, 569*, 587
Articulata, 359*, 360, 361, 362 : Shell,
 360, 361
Ascaridæ, 299*
ASCARIS LUMBRICOIDES, 292 : External
 characters, 292 : Body-wall, 293 :
 Digestive organs, 294, **295** : Body-
 cavity, 295 : Excretory system, 296 ;
 Nervous system, 296, **297** : Repro-
 ductive organs, 296, **297** : Develop-
 ment, 297 : Systematic position, 299
Ascaris megalocéphala, 292
Ascaris suilla, 293
Ascetta, **117**
 Ascon, **118, 119***
Ascopodaria, 347
Asellus, 554, 569, **570**
 Asexual reproduction, 41 : in Amœba,
 46 : Heliozoa, 61 : Radiolaria, 63 :
 Euglena, 71 : Flagellata, 76 :
 Choanoflagellata, 80 : Dinoflagellata,
 81 : Cystoflagellata, 82 : Sporozoa,
 83 : Gregarinida, 86 : Coccidiidea,
 86 : Hæmosporidea, 89 : Myxo-
 sporidea, 90 : *Paramœcium*, 92 :
 Ciliata, 99 : Tentaculifera, 103 :
 Sponges, 122 : Actinozoa, 195 :
 Platyhelminthes, 278 : *Bugula*, 339 :
 Chætopoda, 475
Aspergillum, 678, 683, **684**
Aspidobranchia, 713*
Aspidochirota, 406
Aspidocotylea, 249*, 253, 267
Aspidogaster, 279
Asplanchna, 322, 323, **324**
Astacopsis, 555
Astacus, 555
ASTACUS FLUVIATILIS, **527, 535** : Ex-
 ternal characters, **527** : Abdomen,
 528, **534** : Thoracic region, 528 :
 Head, 529 : Appendages, **529, 530** :
 Articulations, **532** : Body-wall, **533** :
 Muscular system, 533, **534** : Diges-
 tive organs, **535** : Respiratory
 organs, **536, 537** : Excretory organs,
538, 539 : Circulatory organs, **539,**
540, 541 : Nervous system, **541, 542** :

- Sensory organs, 542 : Reproduction, 542, **543** : Development, **544**, **545**, **546**, **547** : Systematic position, 556
Astasiopsis, 73
ASTERIAS RUBENS, 368 : General external features, 368, **369**, 370 : Transverse section of an arm, 370, **371** : Vascular and nervous systems, 372 : Structure of the disc, 373 : Body-wall and cœlome, 373 : Digestive system, 374, **375** : Ambulacral system, 375, **376**, **377** : Reproductive system, **378**, 379 : Systematic position, 405
Asteriida, 405*
Asterina, development, 380, **381**, **382**, **383**, **384**, **385**, 386
Asterina gibbosa, **381**, **382**, **383**, **385**, 420, 423
Asteroidea, Example, 368 : Development, 380 : Distinctive characters and classification, 402 : Apical system, 409 : Modifications of form, 409, **410** : Cœlome, 416 : Ambulacral system, 416, 417 : Blood-vascular system, 417, 418 : Hæmal system, 418 : Axial organ, 419 : Enteric canal, 419, 420 : Nervous system, 420 : Reproductive organs, 420, 421 : Development, 421 : Ethology, 424, 425
Asthenosoma, 412
Astracoidea, 556*
Astræa, 195, **196**, 204
Astropecten, 410, 411
Astrophyton, **412**
Astrosphere, **17**, **18***
Atlanta peronii, **721**
Atrium, 245, 339
Atrochal, 474*
Attraction-sphere, 19*
Auditory organs, 39, 40, 630
Aulactinium actinastrum, **64**
Aulostoma, 504, 510
AURELIA AURITA, 167 : External characteristics, **168**, 169 : Digestive cavity and canal system, 169, **170** : Cell-layers, 170 : Gonads, 171 : Gastric filaments, 171 : Muscular and nervous systems, 171, 172 : Sense organs, **171**, 172 : Development and life-history, 172, **173**, 174, 175 : Systematic position, 176
Auricle, of heart, 37*
Auricles, of Sea-urechin, 389 : of Ctenophora, 220*
Auricularia, 396, 404, **422**, 423
Australian region, 9*
Autogamy, 51, 61
Autolytus cornutus, **475**
Avicularium, 334, **335**, 345*
Axes, **42***, 43
Axial fibre, 94, **98**, **99**
Axial nerve, 400
Axial organ, 378, 392, 419, 421
Axial sinus, 373, 378
Axis-cylinder, 30*, **31**
- B**
- BALANUS**, 551, 563, **564**, 565, 581
Barnacles, 3, 514, 551, 563, **564**, 579, 581
Barrier reef, 207
Basal plate, of coral, 202*, **203**, 204
Bathycytena, 223
Bathynella, 553
Batteries, 161*
Bdelloida, 321*, 323, 327
Bdelloura, 279
Bear-animalcules, **658**, 659
Bee-parasites, 625, 636
Bees, 514, 602, 603, 621, **626**, **631**, 632, **636**, 637
Beetles, 514, 602, 603, **620**, 625
Belemnites, 767, **772**, 780
Benthos, 8*
Berenice, **150**
Beroë, **221**, 223, **226**
Beroida, 218*, **221**
Bicellariida, 341*
Bicellular glands, 485*
Bilateral symmetry, 42, 43*
Bile, 35*
Bilharzia hæmatobia, 280, **281**
Bilharzia japonica, 280
Binomial nomenclature, 1*
Binucleata, 74
Biology, 1*
Bionomics, 9*
Bipalium, **251**
Bipinnaria, 402, 423
Bird-lice, 636
Bird's-Head Coralline, 334
Birgus, 555, 575, 580, 589
Birth-opening, 242*
Bivium, 370, 407 : of Sea-cucumber, 393
Black coral, 193*, **198**, 199, 207
Blastocœle, 24*
Blastoidea, 405*, 426, 428
Blastomeres, 23*
Blastopore, **24***
Blastosphere, 24*
Blastostyle, of *Obelia*, 130*, **131** :
 Leptolinæ, 151 : *Porpita*, **165**
Blastula, 24*
Blatta—See *Periplaneta*
Blattida, 621, 637
Blepharoblast, 72*, 74
Blood, 30*, 35*
Blood-corpuseles, 30
Blood-vascular system—See Vascular system
Blood-vessels, 35
Blow-flies, 620

- Blue coral, 193
Bodotria, 553
 Body-cavity—See Cœlome
 Body-wall, of Sea-anemone, 185 :
Hormiphora, 212 : Liver-fluke, 237 :
 Platyhelminthes, 257 : Nemertinea,
 285 : *Ascaris*, 293 : Nematoda, 299 :
 Chætognatha, 310 : *Brachionus*
rubens, 318 : *Bugula*, 336 : Ecto-
 procta, 344 : *Magellania*, 355 : *Asterias*,
 373 : Sea-cucumber, 394 :
Nereis, 433 : Earthworm, 445 :
 Chætopoda, 463 : *Sipunculus*, 485 :
 Sipunculoidea, 488 : *Hirudo*, 496 :
Apus, 519 : *Astacus*, 533 : Crustacea,
 578 : *Peripatus*, 592 : Myriapoda,
 600 : Insecta, 621
 Bojanus, organ of, 672
Bolina hydatina, 223
 Bone, 27, 28*, 29
 Bone-corpuscles, 28*
Bonellia, 479, 481, 482, 483
 Book-gills, 653
 Book-lungs, 642, 652
 Book-scorpions, 646
Bopyrini, 572
Bopyrus, 554
 Botany, 1*
 Bot-fly, 620, 636
 Bothridia, 255*
Bothriocephalus, 255, 275, 281
Bothriocephalus latus, 281
 Botryoidal tissue, of Leech, 497
Bougainvillea, 144, 152
 Brachial disc, of Discomedusæ, 182
 Brachial ossicles, 398
 Brachiolaria, 402, 423
Brachionidæ, 323*
Brachionus, 317, 318, 319, 320, 321,
 322, 323
 BRACHIONUS RUBENS : External char-
 acters, 317, 318 : Body-wall, 318 :
 Digestive organs, 319 : Body-cavity,
 320 : Excretory system, 320 : Ner-
 vous system and sense organs, 320 :
 Reproduction and development, 320,
 321 : Systematic position, 323
 Brachiopoda, 332, 353* : Example,
 353 : Distinctive characters and
 classification, 359 : Systematic posi-
 tion of example, 359 : General or-
 ganisation, 360 : Shell, 360, 361 :
 Spicules, 361 : Peduncle, 361 : Lo-
 phophore, 361 : Muscular system,
 362 : Enteric canal, 362 : Heart,
 362 : Nephridia, 362 : Nervous sys-
 tem, 362 : Gonads, 362 : Develop-
 ment, 362, 363, 364, 365 : Distri-
 bution, 364
 Brachyura, 555*, 575, 576, 577, 586
 Bract, 160, 162*, 518
 Brain, 38*
 Branchellion, 504, 506, 510
 Branchiæ, 36* : of *Asterias*, 369 : Sea-
 urchin, 388 : Polychæta, 461, 462 :
 Oligochæta, 462 : Branchellion, 507 :
Astacus, 537 : Crustacea, 578 : Ano-
 donta, 668, 669, 670, 671 : Ptele-
 cypoda, 686 : Triton, 706 : Gastro-
 poda, 723
 Branchial formula, of *Astacus*, &c., 538
 Branchionoda, 549*, 555, 556, 557, 578,
 579, 581, 582, 587, 660
Branchipus, 549, 557
 Branchiura, 551*, 559, 562, 563
 Brine-shrimp, 557
Brisingiæ, 410
 Brood-cavity, 103
 Brood-pouch, 363, 519
 Brown body, 339
 Brown tubes, 489*
 Buccal cavity, 33
 Buccal tentacles, 413
Buccinum undatum, 702
 Budding, 41*—See Asexual reproduc-
 tion : in Turbellaria, 251
 Buffon, 5
 Bugs, 619, 625, 636
Bugula, 340
 BUGULA AVICULARIA, 334, 335 : Body-
 wall, 336 : Cœlome, 336 : Alimen-
 tary canal, 336 : Nervous system,
 336 : Excretory organs, 336 : Re-
 productive organs, 336, 337 : De-
 velopment, 337, 338, 339 : Sys-
 tematic position, 341
Bugula plumosa, 338
Bulinus, 241
 Bursa copulatrix, 265, 266, 267, 268, 631
Busyon, 730
 BUTHUS, 638 : External features, 638,
 639, 640 : Digestive system, 640,
 641 : Circulatory organs, 641, 642 :
 Organs of respiration, 642 : Nervous
 system, 641, 642, 643 : Organs of
 special sense, 643 : Reproductive
 organs, 643 : Development, 643, 644
 Butterflies, 514, 602, 620
 Byssus, 677, 684, 685 : provisional,
 675, 685
 Byssus-gland, 677, 685
- C
- CADDIS-FLIES, 618
 Cake-urchins, 403*, 408, 413, 414
 Calcarea, 113*, 121, 122, 123, 125
 Calcareous spicules, of Sponges, 108,
 109, 120, 122, 123
 Calciferous glands, 447
Callianira, 215, 216, 219
Callitirra, 150
Calocalanus, 560
 Calotte, 227*, 338
 Calymma, of Radiolaria, 62

- Calyptoblastea**, 144*
Cambarus, 555
 Cambrian, 7
Campanulariidae, 143*
Campodea, 616
 Canaliculi (bone), 28*
 Canals, Haversian, 28*, 29: incurrent, radial or flagellate, excurrent of Sponge, 108, 109*, 110, 118: of Medusa, 136, 137
 Canal system of Sponges, 118, 119
Cancer, 555, 575
Cannostomæ, 179
 Capillaries, 36*
 Capillary vessels, 235
 Capillitium, of Mycetozoa, 68, 69
Caprella, 554, 571
Capria, 176
 Capsulogenous glands, 446*
Carabus auratus, 626
 Carapace, *Apus*, 515: *Astacus*, 527: of Scorpion, 638
 Carboniferous, 7
 Cardinal process, 354*
 Cardioblasts, 614*
Cardium, 678, 680, 683, 692
 Carina, of Cirripedia, 563
Carinaria mediterranea, 719
 Carp-lice, 551
Carpoidea, 405*, 426
 Cartilage, 27, 28*: Hyaline, 28: Fibrous, 28: Yellow elastic, 28: Calcified, 28
Caryophyllæus, 256, 258, 283
Cassiopia, 182
 Caudal cells, 304
 Caudal spine, 650
 Caudal styles, of *Apus*, 515
 Caudal vesicle, 244*, 275
 Cell, 16, 17*. 18: Forms, 25: Ciliated, 25, 45: Flagellate, 25, 45: Amœboid, 45: Encysted, 45
 Cell, animal, 15, 16*
 Cell-colony, 52*, 67
 Cell-division, 18, 19
 Cell-lineage, 268*
 Cell-plate, 18, 20*
 Cell-wall, 17*
Cellepora, 340
 Cellulose, 15, 66, 69, 71, 75, 76, 80
 Cement glands, 265, 320
 Centipedes, 514, 598, 600
 Central capsule, of Radiolaria, 62: of *Antedon*, 400
 Central nervous system of Medusæ, 151
 Centro-dorsal ossicle, of *Antedon*, 397, 398
 Centrolecithal egg, 217*, 525
 Centrosome, 18*
 Cephalic apodeme, of *Apus*, 520: *Astacus*, 529
Cephalopoda, 663, 738*: Examples, 738, 754: Distinctive characters and classification, 766: Systematic position of the examples, 767: General organisation, 768: External features, 768: Shell, 770: Internal skeleton, 772, 773: Gills, 773: Cœlome, 773: Alimentary organs, 773: Heart and vascular system, 773, 774: Nervous system and sense organs, 774: Osphradia, 774: Statocysts, 774: Kidneys, 774: Sexes, 774: Development, 774, 775, 776, 777, 778, 779: Distribution, &c., 779: Relationships, 780
 Cephalopodium, 740
 Cephalothorax, of *Astacus*, 527
 Cerata, 724
Ceratella, 148
Ceratella fusca, 146, 148
Ceratites nodosus, 772
Ceratium, 81
Ceratosa, 113*, 127
 Cercaria, 241, 242*
 Cerci, 606
 Cerebral organs, 289*, 487
Cerianthus, 197, 200
 Cervical fold, of *Apus*, 515
 Cervical glands, 301
 Cervical groove, of *Astacus*, 528
 Cervical sclerites, 606
Cestida, 218*, 220
Cestoda, 249*, 254, 255, 256, 257, 258, 259, 260, 263, 264, 268, 274, 275, 276, 277, 279, 280, 281; 282, 283, 284: Example, 243
Cestus veneris, 220
Cetonia aurata, 310
 Chætæ, 430—See Seta
Chætoderma, 695, 696, 697, 699
Chætogaster, 475
Chætognatha, 292*, 310*: External characters, 310: Body-wall, 310: Enteric canal, 311: Cœlome, 311: Nervous system, 311: Sensory organs, 311, 312: Reproduction, 312: Development, 312, 313
Clætonotus, 329
Chætopoda, 429*: Examples, 430, 443: Distinctive characters and classification, 454: Systematic position of examples, 455: General organisation, 457: General form, 457: Parapodia and setæ, 458, 459, 460, 461: Branchiæ, 461: Body-wall, 463: Cœlome, 463: Enteric canal, 463: Blood-vessels, 464: Nervous system, 465: Organs of special sense, 466: Organs of excretion, 467, 468, 469: Phosphorescence, 470: Reproductive organs, 470: Development, 471, 472, 473, 474, 475: Asexual reproduction, 475, 476: Mode of life, &c., 476, 477: Appendices, 477, 479

- Chaetopterus*, 458, 470
Chaetosoma, 313
Chaetosomidae, 313*
 Chalk, 59
Charybdoma marsupialis, 179, 180
Chelostomata, 340*, 341, 342, 344, 345, 346
 Chelæ, 530*
 Chelicerae, 638*, 646, 648, 649, 650
Chelifer bravaisii, 646
 Chelipeds, 530*
 Chilaria, 650
Chilina, 726
Chilognatha, 598*
Chilopoda, 600*, 601
Chironomus, 629
 Chitin, 32, 46*
Chiton, 663, 694, 695, 696, 697, 700, 701
Chitonellus, 695
Chlamydomyxa, 65, 66
Chlamydomyris stercorea, 52, 53, 54
Chloramidae, 464
 Chloragen cells, 447
 Chlorophyll, 14, 59, 66, 70, 75, 120
 Choanocytes, 108, 109, 110*, 112
Choanoflagellata, 71*: General structure, 79; Collar, 79, 80; Colonies, 79, 80; Reproduction, 80
Chaetopterus, 458
Chondracanthus, 551, 561, 562
 Chordotonal nerve-endings, 630
 Chorion, of Cephalopoda, 775: of Insects, 612
Choristida, 127
 Chromatin, 17*, 18, 20
 Chromatophores, *Actinosphaerium*, 58, 59: *Chlamydomyxa*, 66: Flagellata, 73, 74: Dinoflagellata, 80, 81: Sepia, 741: Cephalopoda, 770
 Chromidia, 20*, 49
 Chromidiosomes, 20*
 Chromioles, 17*, 19
 Chromosome, 18, 19*
 Chrysalis, 635
Cicada, 619, 631
 Cicatrix, 755
Cidaris, 417
 Cilia, 25*
 Ciliary flames, 263
 Ciliary process, 750
Ciliata, 93*: Form of body, 94, 95, 96, 97, 98, 99, 100: Stalk, 94, 98, 99: Arrangement of cilia, 94, 96, 98: Undulating membranes, 94, 96: Meganucleus, 95, 96: Micronuclei, 95, 96: Contractile vacuole, 95, 96, 98, 99: Non-contractile vacuoles, 95, 96: Trichocysts, 95, 96: Digestive apparatus, 96, 97: Skeleton, lorica, 96, 97, 98: Opereculum, 97, 98: Colonies, 96, 97, 98, 99: Reproduction, 99, 100: Conjugation, 100, 101
 Ciliated chambers, 119
 Ciliated pits, 467*
 Cinelides, 186, 199
 Circulation—See Vascular system
 Circulatory system—See Vascular system
 Cirri, 397*, 429
Cirripedia, 551*, 578, 579, 581, 582, 583, 586, 587
 Cirrus, 237
 Cirrus sac, 245
Cistella, 359, 360, 361, 362, 363, 364
Cladocera, 550*, 557, 558, 581, 583
Cladophiuræ, 403*
 Class, 4*
 Classification, 3*, 5: of Rhizopoda, 46: Mastigophora, 69: Sporozoa, 82: Infusoria, 90: Porifera, 112: Hydrozoa, 141: Scyphozoa, 175: Actinozoa, 191: Ctenophora, 217: Platyhelminthes, 248: Nematina, 290: Nematoda, 298: Rotifera, 321: Polyzoa, 340: Brachiopoda, 359: Echinodermata, 401: Chaetopoda, 454: Sipunculoidea, 488: Hirudinea, 503: Crustacea, 548: Insecta, 615: Arachnida, 615: Pelecypoda, 676: Amphineura, 694: Gastropoda, 713; Cephalopoda, 766
Clathrina, 117, 120, 123, 125
Clathrina blanca, 123, 124, 125
Clathrozoon, 148
Clathruina, 69, 61
Clavatella, 145
 Clavula, 408*
 Cleaning foot, 566, 567
Clepsine, 504, 506, 507, 508, 509, 510
Cliona, 123, 127
 Clitellum, 444, 457, 497
 Cloaca, 245
Clypeaster subdepressus, 414
Clypeastridea, 403*, 408, 413
 Clypeus, 603, 604*, 622
 Cnidoblast, 134*
 Cnidocil, 134*
Coccidia, 632
Coccidiidea, 83*: Characteristic features, 86, 87, 88, 89
Coccidium, 86, 87
 Cockchafer, 628
 Cockles, 663, 678, 680
 Cockroach—See *Periplaneta*
 Cockroaches, 514, 602, 617, 621, 624, 633, 634, 637, 640, 642
 Cocoa-nut crab, 555
 Cocoon, 452, 471
Coonella, 96
Ceolenterata, Classes, 129: Examples, 129, 167, 183, 208: Relationships, 223–227: Appendix, 227: Relationships to Sponges, 226
 Cœliac canal, 399

- Cœlome and body cavity, of *Ascaris*, 295: Nematoda, 301: Acanthocephala, 307: Chaetognatha, 311: *Bugula*, 336: Endoprocta, 347: *Phoronis*, 349: *Magellania*, 358: *Asterias*, 373: Sea-urchin, 392: Sea-cucumber, 394: *Antedon*, 398: Echinodermata, 416: *Nereis*, 432: Chaetopoda, 463: *Sipunculus*, 486: Gephyrea, 488: *Apus*, 521: Crustacea, 578: *Peripatus*, 592: Insecta, 625: *Anodonta*, 667: Amphineura, 697: *Sepia*, 745: Cephalopoda, 773
- Cœlomoducts, 429, 469
- Cœloplana*, 221, 222, 282
- Cœnenchyma, 205*
- Cœnosarc, 132*
- Coleoptera**, 620*, 624, 630, 632, 637
- Collar of choanoflagellata, 79, 80
- Collared cells, 108, 110*, 112
- Collared monads, 79, 80
- Collembola**, 616*
- Collencytes, 108, 112*
- Colleterial glands, 612
- Collozoum*, 63, 65
- COLOCHIRUS**, 393: General external features, 393: Structure of body-wall, 394: Ambulacral system, 394: Nerve-ring, 394: Perihæmal and hæmal systems, 394: Cœlome, 394: Enteric canal, 395: Reproductive organs, 396: Development, 396: Systematic position, 406
- Colony, 41*: of Foraminifera, 53: Heliozoa, 59: Radiolaria, 63: Flagellata, 75, 76: Choanoflagellata, 80: Ciliata, 98: Tentaculifera, 103: *Obelia*, 130: Leptolinæ, 143: Actinozoa, 195: Polyzoa, 333: *Bugula*, 334: Ectoprocta, 341: Endoprocta, 348
- Colpoda*, 99
- Columnella, of Coral, 202*: of Triton, 703
- Column, 185*
- Comatulæ*, 425, 426
- Comatulidæ*, 406
- Comb-jellies, 129
- Comb-ribs, 210*
- Combs, of *Hormiphora*, 208*, 209, 210
- Commensalism, in Sponges, 127: *Hydractinia*, 147: Actinozoa, 205: Platyhelminthes, 279: Chaetopoda, 476: Crustacea, 586
- Complemental males, 582
- Conchiolin, 666*
- Conchostraca**, 550*
- Condylostoma*, 96
- Cone, of Coronata, 178
- Cones, 714
- Conjugation, 61*: of *Amœba*, 47: Foraminifera, 56: Heliozoa, 61: Flagellata, 79: Cystoflagellata, 82: *Paramœcium*, 92: Ciliata, 100
- Connective tissue, 27*: Gelatinous, 27: Fibrous, 27: Fatty, 27, 28: Retiform, 27
- Connective tissue cells of Sponges, 112
- Contractile vacuole, 10, 12*, 13, 14, 46, 47, 68, 70, 79, 80, 91
- Contractility of muscles, 29, 38*
- Conus*, 730
- Convoluta*, 251, 260
- Copepoda**, 550*, 559, 578, 579, 581, 582, 583
- Copromonas subtilis*, 77, 78
- Copulation, 50*, 78
- Coral, Aporose, 205*: Black, 193, 207: Blue, 193, 205: Fossil, 208: Organ pipe, 193, 195: Perforate, 205*: Red, 193, 201, 207: Reef-building, 207: Stony, 129, 193, 199
- Coral limestones, 207, 208
- Coral reefs, 159, 207
- Corallines, 129, 333
- Corallite, 202*
- Corallium*, 193, 195, 196, 201, 205, 207
- Corallum, 204*
- Cordylophora*, 166, 258
- Cornea, 750*: false, 749, 750*
- Corona, of Polyzoa, 338: Sea-urchin, 388
- Coronary groove, 175, 177, 178*
- Coronata**, 175*, 177, 178, 179
- Corpuscles, 30: amœboid, 30: Miescher's or Rainey's, 90
- Cortex, of *Actinosphærium*, 58, 59: *Monocystis*, 82: *Paramœcium*, 90, 91: Sponges, 111, 119, 120
- Corymorpha*, 145, 148
- Couplers, 561
- Covered-budded Hydroids, 144
- Cowries, 714
- Coxa, 606
- Coxal glands, *Peripatus*, 593: Scorpion, 642: Arachnida, 651
- Coxal organs, 593
- Crabs, 515, 555, 572, 575, 578, 580, 581, 585, 589
- Crane-flies, 620
- Crangon*, 573
- Crania*, 359, 360
- Crayfish, 527—See *Astacus*
- Crayfishes, 515, 555, 572, 580, 585
- Cretaceous, 7
- Crickets, 621
- Crinoidea**, 368, 404*: Example, 396: Distinctive characters and classification, 404: Apical system, 403: Modifications of form, 415: Cœlome, 416: Ambulacral system, 417: Blood-vascular system, 418: Hæmal system, 418: Enteric canal, 419: Nervous system, 420: Reproductive organs, 421: Development, 421: Ethology, 425, 426
- Crioceris*, 620

Crisia, 340
 Crista acustica, 750*
Cristatella, 341, 343
 Crop, 33
 Crown, of *Coronata*, 178
 Crural glands, 593
Crustacea, 514, 662 : Example *a*, 514 : Example *b*, 527 : Distinctive characters and classification, 543 : Systematic position of the examples, 555 : General organisation, 556 : External characters and structure of appendages, 556 : Texture of the exoskeleton, 578 : Body-cavity, 578 : Enteric canal, 578 : Respiratory organs, 579 : Heart, 581 : Excretory organs, 581 : Nervous system, 581 : Sense organs, 581 : Reproduction, 582 : Development, 582 : Ethology, 585 : Affinities and mutual relationships, 587 : Appendix, 589
Cryptocephala, 455*, 457, 464, 465, 472, 477
Cryptomonas, 73
Cryptoniscus, 572
 Crystalline style, 668 : of *Gastropoda*, 724
Ctenaria, 150, 224, 225
 Ctenidium, 669, 670, 671, 686 : of *Triton*, 706 : of *Gastropoda*, 722, 723
Ctenodrilus, 492
Ctenophora, 129, 208 : Example, 208 : Distinctive characters and classification, 217 : Systematic position of the example, 218 : General organisation, 219, 220, 221, 222, 223 : Relationships, 223
Ctenoplana, 221, 222, 282
Ctenopteryx, 768
Ctenostomata, 340*, 342, 344, 346
Cubomedusæ, 175*, 179, 180, 181
Cucumaria—See *Colochirus*
Cucumaria planci, 393
Culex, 619, 623
Cuma, 553
Cumacea, 553*, 568, 579, 587
Cunarcha, 155
Cunina, 166
Cunina parasitica, 156
 Cup-coral, 202
Cursoria, 617, 621
Cuspidaria, 678
 Cuticle, 32*
 Cuttle-fish, 663, 738, 767
 Cuvier, 3
 Cuvierian organs, 419
Cyamus, 554, 571
Cyanea arctica, 181
Cyanophyceæ, 74
Cyclus, 691
Cyclidium, 96
Cyclops, 551, 559, 560, 581, 582
Cylostomata, 340*, 342, 345, 346, 347

Cydippe, 208
Cydippida, 218*, 219
Cymothoa, 572, 582
Cynipida, 632
Cyphonantes, 346
 Cypræa, 719
Cypris, 550, 558, 559, 581
 Cypris stage, of *Cirripedes*, 551, 583
 Cyst, 13*, 71 : *Amœba*, 46*, 47 : *Didymium*, 68 : *Euglena*, 70, 71 : *Monocystis*, 82, 83
Cysticercoid, 275
Cysticercus, 247, 275, 276
Cysticercus cellulose, 281
Cystoflagellata, 71* : Characteristic features, 81
Cystoidea, 405*, 426, 428
Cythere, 550, 558, 559
 Cytoplasm, 17*

D

D
DACTYLOPORES, of *Millepora*, 157* : *Stylaster*, 159
 Dactylozooids, 149*, 164 : of *Millepora*, 158, 159 : *Stylaster*, 159 : *Halistemma*, 160, 162
 Daddy long-legs, 620
 Dahlia wartlet, 184, 185
Dallingeria, 73
Dalmanites socialis, 589
Daphnia, 550, 558
 Darwin, 6
Dasychone, 466
 Daughter-cell, 20*
 Daughter-chromosomes, 19*
 Daughter-cysts, 278
 Daughter-nucleus, 19*
 Daughter-segments, 19*
 Day-flies, 626, 637
 Dead men's fingers, 193, 200
Decapoda, 554*, 556, 572, 579, 581, 582, 584, 585, 586, 587, 588
Decapoda (Cephalopoda), 767*, 768, 781
 Degeneration, in *Copepoda*, 562, 563 : in *Cirripedia*, 565 : in *Isopoda*, 572
Deiopea, 220
 Deltidium, 353*
 Deltoid plates, 405
Demospongia, 113*
Dendrochirotae, 406*
Dendrocxlum—See *Planaria*
Dendrocometes, 102
Dendrophyllia, 204, 205
Dendrosoma, 102, 103
Dentalium, 736, 737
 Dentary region, 432
 Denticles, 432
Depastrida, 176
 Derm (dermis), 32*

- Dermal branchiæ, 369, 388, 416 : of Echinoidea, 388
 Dermal cortex, 109, 111*, 119, 120
 Dermal pores, 369
 Dermis, 32*
Desmoscolecida, 314, 315
Desmoscolex, 314, 315
 Destructive metabolism, 13*
 Deutomerite of *Gregarina*, 84, 85*
 Development of Sponges, 122, 123 :
Sycon, 124, 125, 126 : *Obelia*, 140 :
Leptolina, 152 : *Trachylina*, 156 :
Aurelia, 172, 173, 174 : Sea-anemone, 190 : *Hormiphora*, 214 :
Dicyemida, 228, 229 : *Rhopalura*, 229, 230 : *Planaria*, 236 : Liver-Fluke, 240, 241 : *Tænia*, 246, 247 :
 Platyhelminthes, 268-278 : Nemeritina, 290 : *Ascaris*, 297 : Nematoda, 303, 304 : Chætognatha, 312, 313 :
Brachionus rubens, 321 : Rotifera, 328 : *Bugula*, 337 : Ectoprocta, 345 :
 Endoprocta, 348 : *Phoronis*, 351, 352 : Brachiopoda, 362, 363, 364 :
Asterina, 380-386 : Sea-urchin, 392 :
 Sea-cucumber, 396 : Echinodermata, 421 :
Antedon, 423, 424 : *Nereis*, 440, 441, 442, 443 : *Lumbricus*, 452, 453, 454 : Chætopoda, 471 : Echiurida, 482, 483, 484 : *Hirudo*, 503 :
 Hirudinea, 508, 509 : *Apus*, 525, 526 : *Astacus*, 544, 545, 546, 547 :
 Crustacea, 582, 583 : *Peripatus*, 595, 596, 597 : Myriapoda, 601, 602 :
Periplaneta, 612, 613 : Scorpion, 643, 644 : *Anodonta*, 674, 675, 676 :
 Pelecypoda, 691, 692 : Amphineura, 700, 701 : Gastropoda, 729-735 :
 Scaphopoda, 737, 738 : Cephalopoda, 774-779
 Devonian, 7
Diastylis, 553, 568
Dibothriocephalus, 268
Dibranchiata, 767*, 770, 771, 772, 773, 774, 780
Diceras, 682
Dichyocysta, 97
Dicrocalium lanceolatum, 280
Dicyclica, 405*
Dicyema, 227, 228, 229
Dicyemida, 227, 228, 229
Didinium, 95, 96
 DIDYMIUM DIFFORME, 68, 69
 Differentiation, 25*
Diffugia, 49
Digenetica, 249*, 253, 260, 263, 266, 267, 268, 272, 273, 280, 282
 Digestion, intracellular, 34
 Digestive glands, 33
 Digestive system, 33* : of *Paramæcium*, 92 : Ciliata, 97 : *Aurelia*, 169, 170 :
 Sea-anemone, 185 : Actinozoa, 199 :
Hormiphora, 210, 212 : *Planaria*, 233, 234 : Liver-Fluke, 238 :
 Platyhelminthes, 260, 261, 262 : Nemeritina, 286, 287 : *Ascaris*, 294, 295, 296 : Nematoda, 300, 301 : Chætognatha, 311 : *Brachionus rubens*, 319, 320 : Rotifera, 326, 327 : *Bugula*, 336 : Ectoprocta, 344 : Endoprocta, 347 : *Phoronis*, 349 : *Magellania*, 355, 356 : *Asterias*, 374, 375 : Sea-urchin, 391, 392 : Sea-cucumber, 395, 396 : *Antedon*, 399 : Echinodermata, 419, 420 : *Nereis*, 432 :
Lumbricus, 446, 447, 448 : Chætopoda, 463, 464 : *Sipunculus*, 486, 487 : *Sipunculoidea*, 489 : *Hirudo*, 497, 498 : Hirudinea, 505 : *Apus*, 520, 521 : *Astacus*, 535, 536, 537 :
 Crustacea, 578 : *Peripatus*, 592, 593 :
 Myriapoda, 601 : *Periplaneta*, 608, 609 : Insecta, 626, 627 : Scorpion, 640, 641, 642 : Arachnida, 651, 652 :
Anodonta, 668 : Pelecypoda, 687, 688 : Amphineura, 696, 697 : *Triton*, 707, 708, 709 : Gastropoda, 724 :
 Scaphopoda, 736 : *Sepia*, 742, 743, 745 : *Nautilus*, 761, 762 : Cephalopoda, 773
Dimorpha, 72, 73
 Dimorphism, in Foraminifera, 56 : in Radiolaria, 65 : in Flagellata, 79 :
 in Ciliata, 99
 Dimorphism, sexual, 40*
Dimorphograptus, 166
Dimyria, 286
Dinobryon, 73, 77
 Dinoflagellata, 71* : Characteristic features, 80, 81
Dinophileia, 317, 330
Dinophilus, 330, 331, 511, 512
 Dicecious, 40*, 140*
Diophrye, 94, 96
Diphyes, 164
 Dipleurnla, 422*
Diplomita, 73
 Diplopoda, 598*, 600, 601, 602
 Diplozoon, 273
 Diptera, 619*, 623, 624, 625, 629, 631, 632, 634, 635, 637
 Directive mesenteries, of Sea-anemone, 188*
 Disc, 185*
 Disc-jellies, 181
Discina, 359, 360, 361
Discocalis, 269
 Discoidal segmentation, 643
 Discomedusæ, 175*, 181, 182, 183
Discorbina, 54
Discosoma, 206, 207
 Dissepiments, 202*
 Distinctive characters—See Classification
Distomida, 249*, 250
Distomum, 259

DISTOMUM HEPATICUM, 236 — See *Fasciola hepatica*
Distomum rathousii, 280
 Distribution, 8 : of Sponges, 125 : Hydrocorollina, 159 : Scyphozoa, 183 : Actinozoa, 207 : Ctenophora, 223 : Platyhelminthes, 279 : Ectoprocta, 346 : Brachiopoda, 364 : Sipunculoidea, 490 : Hirudinea, 510 : Onychophora, 597 : Pelecypoda, 692 : Amphineura, 701 : Gastropoda, 735 : Cephalopoda, 779
 Distribution, geographical, 8
 Distribution, geological, 8* : of Foraminifera, 58 : Sponges, 125, 126 : Corals, 208 : Brachiopoda, 364, 365 : Chatopoda, 477 : Insecta, 637 : Arachnida, 656 : Cephalopoda, 780
 Distribution, vertical, 8*
 Divaricators, 357
Dochmius duodenalis, 300, 301
Docoglossa, 714*, 736
 Doctrine of descent, 6
Donax, 687
Doris, 715, 719, 723
Doris (Archidoris) tuberculata, 719
 Dorsal cirri, of *Antedon*, 397
 Dorsal organ, of *Apus*, 515*
 Dorsal pores, of Earthworm, 445
 Dorsal surface, 43*
 Dragon flies, 618, 629
Drepanophorus, 285
Drilophaga, 328
Dromia, 586
 Ductus ejaculatorius, 296*
Dytiscus, 630

E

EAR, 40*
 Ear-shells, 714
 Earthworm—See *Lumbricus*
 Earthworms, 429
 Earwigs, 621
 Ecdyses, of *Apus*, 526
Echinidæ, 406*
Echinoderes, 314
Echinoderidæ, 314
Echinodermata, 368* : Examples, 368, 386, 393, 396 : Distinctive characters and classification, 401 : Systematic position of examples, 405 : General organisation, 406 : General form and symmetry, 406 : Systems of plates, 409 : Modifications of form, 409 : Cœlome, 416 : Ambulacral system, 416 : Blood-vascular system, 417 : Hæmal system, 418 : Axial organ, 419 : Enteric canal, 419 : Nervous system, 420 : Sexes, 420 : Development and metamorphosis, 421 : Echinopædium, 422 : Ethology, &c., 424 : Self-mutilation and regeneration, 425 : Affinities, 426
Echinoidea, 368, 403* : Example, 386 : Distinctive characters and classification, 403 : Apical system, 409 : Modifications of form, 409 : Dermal branchiæ, 416 : Stewart's organs, 416 : Ambulacral system, 416 : Blood-vascular system, 417 : Hæmal system, 418 : Axial organ, 419 : Enteric canal, 419 : Nervous system, 420 : Reproductive organs, 420 : Development, 421 : Ethology, 424
Echinopædium, 422*
Echinorhynchus, 307, 308, 309, 310
ECHINUS, 386 : General external features, 386, 387, 388 : Corona, 388 : Aristotle's lantern, 389, 390 : Nervous system, 390 : Ambulacral system, 390, 391 : Enteric canal, 391, 392 : Cœlome, 392 : Blood-vascular system, 392 : Reproductive organs, 392 : Development, 392 : Systematic position, 406
Echiurida, 429, 461, 479*, 480, 481, 482, 483, 484, 511, 512
Echiurus, 479, 480, 481, 482, 483
Ectobranchiata 406*
 Ectocyst, 334*
 Ectoderm, 24*—See Body-wall
Ectoprocta, 340*, 341 : Structure of body-wall, 344 : Alimentary canal, 344 : Nervous system, 344 : Nephridia, 344 : Avicularia, 345 : Vibracula, 345 : Reproduction and development, 345 : Ethology and distribution, 346
 Ectosarc, 46*
Edriasteroidea, 405*, 426
Edwardsia, 193, 200, 224, 227
 Eggs—See Development
Eimeria, 86
 Ejaculatory duct, 239
Elasipoda, 404*, 419, 425
Eledone moschata, 774
 Elephant's tusk shells, 736
Eleutherozoa, 401*
 Elk-horn coral, 156, 157
 Elytra, of Polychæta, 460 : Cockroach, 606 : Coleoptera, 620, 625
Embiidæ, 617*
 Embryology, 3*—See Development
Empis, 629
 Emulsions, 35*
 Encystation, 45*, 61
 Endites, 518
 Endocyst, 334*
 Endoderm, 24*
 Endoderm-disc, of *Astacus*, 545
 Endoderm lamella, 137*
 Endogastric, 755*
 Endophragmal system, of *Astacus*, 529
 Endoplasm, 11*, 46*

- Endopodite, 526*
- Endoprocta**, 332, 341*, 347: Vestibule, 347: Nephridia, 347: Cloaca, 347: Ganglion, 347: Testes and ovaries, 347: Foot-gland, 348: Development, 348
- Endosarc, 46*
- Endoskeleton, 32*
- Endosternite, 640*, 651
- End-sac, 522
- Entamæba histolytica*, 51
- Enteric canal—See Digestive system
- Enterocœle, 382
- Enterozoa**, 106
- Entobranchiata**, 406*
- Entovalva*, 693
- Environment, 9*
- Eocene, 7
- Eolis*, 715, 723, 724
- Epeira diadema*, **648**
- Ephelota*, **102**, 103
- Ephemera*, **618**
- Ephemeridæ*, 626, 637
- Ephippium, 582
- Ephyropsis*, 178, 179
- Ephyra, of *Aurelia*, 174*
- Epiblast, 24*
- Epibolic gastrulation, 270
- Epiboly, 216*
- Epicranium, 603*, 622
- Epidermis, 24*, 32—See Body-wall
- Epimerite of Gregarinida, **84**, **85***
- Epineural canals, 391*
- Epipharynx, 627
- Epiphragm, 718
- Epiphysis, of Sea-urchin, 389
- Epipodite, 531*
- Epipodium, 720*
- Epistoma, of *Astacus*, 529
- Epistome, 333, **344**, 349
- Epistylis plicatilis*, 94, **96**
- Epistylis umbellaria*, **94**, **95**
- Epitheca, 202*
- Epithelia, **25**, 26*: Non-stratified, **25**, 26*: Stratified, **25**, 26*
- Epithelium, enteric, 34*
- Epithetosoma*, 480, 482
- Equatorial plate, 19*
- Equivalve, 682*
- Ergasilus*, 551, **561**, 562
- Estheria*, 550, **557**
- Ethiopian, 9*
- Ethology, 9*: of Platyhelminthes, 279: Rotifera, 328: Ectoprocta, 346: Echinodermata, 424: Chaetopoda, 476: Hirudinea, 509: Crustacea, 585: Insecta, 636: Arachnida, 655: Pelecypoda, 692: Amphineura, 701: Gastropoda, 735
- Eucarida**, 554*, 572
- Euchlanis*, 322
- Euchlora*, **219**
- Eucirripedia**, 551*, 563, 565
- Eucope*, development, **153**
- Eucopella*, **185**
- Eucopepoda**, 551*, 559, **560**, **561**
- Eudendrium*, **140**
- EUGLENA VIRIDIS, 69, **70**, 92: Systematic position, 71
- Euglenidæ*, 71
- Euglenoidea*, 71
- Euglypha*, 52
- Eulamellibranchiata**, 678*, 679, 680, 693, 694
- Eumalacostraca**, 552*, 567
- Euphausia*, 554, **580**, 582, 584
- Euphausiacea**, 554*, 572, 579, **580**, 584, 588
- Euphrosyne*, 458
- Euphyllopoda**, 581
- Euplectella*, 122
- Eupolia*, 287
- Eupomatus*, **474**
- Euryalida**, 408, 411, **412**
- Eurypauropus*, 598
- Eurypterida**, 646*, 650, 651, **652**, 656, 662
- Eurypterus fischeri*, **652**
- EUSCORPIO—See BUTHUS
- Euscorpis carpallicus*, **644**
- Euscorpis italicus*, **655**, **656**
- Euspongia*, **116**, **121**
- Euthyneura**, 714*, 717, 722, 726, 728
- Evolution, 6
- Examples, of Rhizopoda, 46: Mycetozoa, 68: Mastigophora, 69: Sporozoa, 82: Infusoria, 90: Porifera, 106: Hydrozoa, 129: Scyphozoa, 167: Actinozoa, 183: Ctenophora, 208: Platyhelminthes, 233, 236, 243: Nematoda, 292: Rotifera, 317: Polyzoa, 334: Branchiopoda, 353: Asterozoa, 368: Echinozoa, 386: Holothurozoa, 393: Crinozoa, 396: Chaetopoda, 430, 443: Sipunculozoa, 484: Crustacea, 514, 527: Insecta, 603: Arachnida, 638: Pelecypoda, 663: Gastropoda, 702: Cephalopoda, 738, 754
- Excretion, 13*, 37
- Excretory aperture, 742*
- Excretory pores, 212, 293
- Excretory system, of Leptolinae, 151: *Planaria*, 235: Liver-Fluke, 238: *Tænia*, 244: Platyhelminthes, 263: Nematinae, 287: *Ascaris*, 296: Nematodea, 302: *Echinorhynchus*, 308: *Brachionus rubens*, 320: Rotifera, 327: *Bugula*, 336: Ectoprocta, 344: Endoprocta, 347: *Phoronis*, 349: *Magellania*, 358: Branchiopoda, 362: *Nereis*, 437, **438**: *Laubricus*, 449, **450**: Chaetopoda, 467, **468**, **469**: *Sipunculus*, 487: Sipunculozoa, 489: *Hirudo*, **498**, 499, **500**: Hirudinea, 506, **507**: *Apus*, **522**: *Astacus*,

- 538, 539**: Crustacea, 581: *Peripatus*, **594**: *Periplaneta*, 609: Insecta, 627: Scorpion, 641: Arachnida, 651: *Anodonta*, 671: Pelecyopoda, 688: Amphineura, 699, **700**: *Triton*, 711: Gastropoda, 728: Scaphopoda, 737: *Sepia*, **751, 752**: *Nautilus*, 763, **764**: Cephalopoda, 774
- Excurrent canals, of Sponges, **109, 110***
- Exhalant siphon, 664
- Exit, 518
- Exogastric, 755*
- Exoplasm, 11*, 46*
- Exopodite, 526*
- Exoskeleton, 32*—See Body-wall
- External features, of *Sycon*, 106, **107**: of Porifera, 115, **116, 117, 118**: *Obelia*, **131**: *Aurelia*, **168, 169**: Sea-anemone, **184, 185**: Actinozoa, 194: *Hormiphora*, **208, 209, 210**: *Planaria* and *Dendrocalum*, 233: Liver-Fluke, 236, **237**: *Tania solium*, **242, 243**: Platyhelminthes, 250: Nemertinea, 284: *Ascaris lumbricoides*, 292: Nematoda, 299: *Echinorhynchus*, **307**: Chaetognatha, 310: *Brachionus rubens*, 317, **318**: Rotifera, 323: *Bugula avicularia*, 334: Ectoprocta, 341, **342, 343**: Endoprocta, 347: *Phoronis*, **348, 349**: *Magellania*, 353, **354**: Brachiopoda, 359: *Asterias rubens*, 368, **369, 370**: *Anthenea flarescens*, **379, 380**: Sea-urchin, **386, 387, 388**: Sea-cucumber, **393**: *Antedon rosacea*, 396, **397, 398**: Echinodermata, 406: Ophiuroidea, 406, 407: Holothuroidea, 407: Asteroidea, 409, **410**: Echinoidea, **412**: Crinoidea, **415**: *Nereis*, **430, 431**: *Lumbricus*, 443, **444**: Chaetopoda, **457, 458**: *Sipunculus nudus*, 484, **485**: Sipunculoidea, 488: Priapuloida, 490: Archi-annelida, **491**: *Hirudo*, 494, **495, 496**: Hirudinea, 505: *Apus*, **515**: *Astacus*, **527, 528**: Crustacea, 556: *Peripatus*, **591, 592**: Myriapoda, 600: *Periplaneta*, 603, **604**: Insecta, 621: Scorpion, 638, **639**: Arachnida, **646**: *Anodonta*, 663, **664**: Pelecyopoda, 679: Amphineura, **695, 696**: *Triton*, 704: Gastropoda, 715: Scaphopoda, 736: *Sepia*, 738, **739**: *Nautilus*, 755: Cephalopoda, **768**
- Ex-umbrella, 135*
- Eyes, 39*: of *Euplena*, **70**: *Medusa*, 155: *Planaria*, 233, **234**: Platyhelminthes, 263: Nemertinea, 289: Nematoda, 302: Chaetognatha, 311: *Brachionus*, 320: Rotifera, 327: *Dinophilus*, 330: Brachiopoda, 362: *Asterias*, 370: *Nereis*, **437**: Chaetopoda, 466, 467: *Hirudo*, **502**: *Apus*, 523, **524**: *Astacus*, 542: Crustacea, 581, 582: *Periplaneta*, 611: Insecta, 629, **630**: Arachnida, 653, **655, 656**: Pelecyopoda, **689, 690**: *Chiton*, 699: *Triton*, **712**: Gastropoda, 726, **727**: *Sepia*, **749, 750**: *Nautilus*, 765

F

- F**
- F** *ABRIGIA*, 466
- Facets, 542*
- Facial suture, 590*
- Faeces, 34*
- Falciform young—See Sporozoites
- Family, 4*
- FASCIOLA HEPATICA, 236: General features, **237, 239**: Body-wall, 237, **238**: Digestive system, 238: Water-vessels, 238: Nervous system, 238: Reproductive organs, **239, 240**: Development, 240, **241**: Systematic position, 250
- Fascioles, 408*, 413*
- Fasciolina*, 250
- Fat, 27*, **28**
- Fat body, of *Periplaneta*, 608
- Fauna, 8*
- Feather-star—See *Antedon rosacea*
- Feeding, method of, *Amata*, 12, 46: *Actinophrys*, 59: *Chlamydomyza*, 67: *E. glena*, 70, 71: Flagellata, 73, 75: Choanoflagellata, 80: *Monocystis*, 83: Tentaculifera, 101
- Femur, of Cockroach, 606
- Fenestrae, of *Periplaneta*, 604*
- Ferment, 12*
- Fertilisation—See Impregnation
- Fever, parasite of, Quartan, **88, 89**: Tertian, **88, 89**
- Fibres, nerve, 30*, **31**
- Fibro-cartilage, **28***
- Filaria bancrofti*, 304, 306
- Filaria medicensis*, 299, 306
- Filariasis, 306
- Filibranchia, 677*, 678, 679, 693, 694
- Filosa, 48*, 52
- Fimbriae, of Fresh-water Mussels, 664
- Fire-flies, 630
- Fission, 14, 41*, 46, 49, **50, 51, 52, 61, 66, 71, 75, 76, 80, 81, 83, 92, 103**
- Fissurella, 717, 726
- Five-chambered organ, 400*
- Fixed cheek of Trilobites, **589, 590**
- Flabellum*, 202, **203, 205**
- Flagella of Copepods, 551*
- Flagellata, 71*: Cell body, 72, **73**: Flagella, 70, **73**: Modes of nutrition, 75: Skeleton, 75: Colonies, 75, 76: Asexual multiplication, 76: Sexual reproduction, 78

- Flagellate canals, of Sponges, **108, 109***,
 110, 119
 Flagellate cells, 110*, 119
 Flagellulæ, **51***, 56, **60**, 61, 63, 67, 69,
 71, 80, **81**, 82
 Flagellum, 25*, 69, **70**, 71: of *Astacus*,
 531
 Flame-cells, 235, 263, **264**
 Flat-worms—See Platyhelminthes
 Fleas, 620, 625, 636
 Flies, 514, 602
 Float, **160**, 161*
Floscularia, 321, 323, **324**, 325
Flustra, 340
Folliculina, **96**
 Food vacuole, of *Actinophrys*, 59:
 Paramoecium, 92*
 Food-yolk, 31
 Foot, of *Anodonta*, 664: Pelecypoda,
 683: Amphineura, 695: *Triton*, 705,
 706: Gastropods, **719**: *Sepia*, 739,
 740: *Nautilus*, 756: Cephalopoda,
768
 Foot-gland, 348
 Foraminifera, 48*: General structure,
51, 52, 53, 54: Skeleton, **53, 54, 55**,
 56: Protoplasm, **55**, 56: Dimor-
 phism, 56*, **57**: Reproduction, 56:
 Distribution, 58
Forcipulata, 402*
 Forcipulate pedicellariæ, 370*
Formica rufa, **636**
 Fossettes, 577*
 Fossils, 7*
Fossula, 208
Fredericella, 341
 Fresh-water Crayfish, 527
 Fresh-water Mussel—See *Anodonta*
 Fresh-water Sponges, 126, 127
 Fresh-water Worms, 429
Fritillaria, 231
Fronicularia, **54**
 Frontal suture, 590*
 Fulcrum (of Rotifera), 319
Fungia, 203
 Funiculus, 336*, 344
 Funnel, 770
 Funnel folds, 770
- G
- GALATHEA**, 555
Galea, 605
Galeodes, 645, **647**
Galeolaria caespitosa, 457
 Gall-flies, 621, 632
 Gall-insects, 632
 Galls, 632*
 Gametes, 50*, 78: of Flagellata, **76**,
 79*: Sporozoa, **82**, 83
 Gametocytes, **82**, 85*, **88**, 89
Gammarus, 554, **569**
Gamobium, 141*, 175
 Gamogenesis, 22*
 Ganglia, 38, 238
 Gastral cortex, **109**, 111*, 120
 Gastric filaments, of *Aurelia*, 171*
 Gastric mill, 578: of *Astacus*, 535
 Gastric ostium, 111*
 Gastric ridges, of *Aurelia*, 172*:
 pouches, 169*
Gastroides, 221, 223
 Gastroith, 536*
Gastrophilus equi, **619**, 620
Gastropoda, 663, 702*: Example, 702:
 Distinctive characters and classifica-
 tion, 713: Systematic position of ex-
 ample, 715: General organisation,
 715: External features, symmetry,
 &c., 715: Shell, 717: Foot, **719**:
 Head, 720: Mantle, 722: Respira-
 tory organs, 722: Osphradium, 724:
 Digestive organs, 724: Heart, 725:
 Nervous system, 725: Organs of
 special sense, 726: Excretory organs,
 728: Reproduction, 728: Develop-
 ment, 729, **730, 731, 732, 733, 734**,
 735: Ethology and distribution, 735:
 Relationships, 736: Appendix, 736
 Gastropores, of *Millepora*, 157*
Gastrotricha, 317, 328*, **329**
 Gastrozooids, 164, 199
 Gastrula, **24***
 Gastrulation, **24***
Gelasimus, **576**, 586
 Gemmules, **112**, 122*
 Genæ, 604*
 Generic, 1*
 Genital cloaca, 245*: rachis, 378, **421**:
 stolon, 378, 421: plates, **389**: bursæ,
 420: operculum, 640*
 Genital system—See Reproductive sys-
 tem
 Genus, 1*
 Geological distribution—See Distribu-
 tion, geological
Geoplanida, 249
Gephyrea, 490
 Germarium, 236*, 265, 267
 Germinal bands, of *Clepsine*, 509: of
 Peripatus, 597
 Germinal disc, 775
 Germinal layers, 24*
 Germinal spot, 20*, **21**, 31
 Germinal vesicle, 20*, **21**
 Germ-vitellarium, 265
 Giant Clam, 692
 Giant fibres, 466
 Giant nerve-cells, 466
Gigantorhynchus, **307, 308, 309, 310**
 Gill cover, of *Astacus*, 528
 Gills, 36*—See Respiration
 Gizzard, 33
 Glabella, 590*
 Glands, 26*

Glands, Multicellular, **26*** : Unicellular, **26*** : Ducts, **26**, **34** : Salivary, **34***
 Glandular portion, **671***
 Glass-crab, **585**
 Glass-rope sponge, **122**, **127**
Glenodinium, **81**
Globigerina, **54**, **58**
Glochidium, **675**
Glomeris, **277**
Glossiphonia, **504**, **510**
Glossocodon, **154**
 Glow-worms, **630**
Glycera, **462**, **463**
Glyceriæ, **464**
 Gnathobase, **518**
Gnathobdellida, **504***, **505**, **509**
 Gnats, **619**
 Goblet-shaped bodies, **449**
 Goblet-shaped organs, of Leech, **502**
 Gonads—See Reproductive system
 Gonapophyses, **612***
 Gonocœle, **761***
Gonodactylus, **555**
 Gonodendra, **164***
 Gonoducts, **489***
Gonopodaria, **347**
 Gonopore, **293**
 Gonotheca, of *Obelia*, **130**, **131**
 Gonozooids, **199***
Gordius, **299**, **300**, **301**, **302**, **303**, **511**
Gorgonacea, **193***, **201**, **202**
Gorgonia, **195**, **201**
 Granule glands, **264**, **266***
 Granules, **380**
Grapsus, **555**
Graptolithida, **143***, **166**
 Grasshoppers, **602**, **616**, **621**, **630**
 Green gland, of *Astacus*, **538**
Gregarina, **84**, **85**, **86**
Gregarina blattarum, **84**
Gregarina dyardini, **84**
Gregarina gigantea, **84**, **86**
Gregarinida, **83*** : Characteristic features, **84**, **85**
Gressoria, **617**, **621**
Gromia, **53**, **54**, **56**, **58**
 Guard, **772***
 Guard-polypes, **149***
 Guinea-worm, **299**, **306**
 Gula, **622***
 Gullet, **33**—See Digestive organs
Gunda segmentata, **251**, **252**, **287**
 Gustatory organ, **39***
Gyge, **572**
Gymnoblæstea, **144***
Gymnolæmata, **340***, **341**, **343**, **345**
Gyraetis, **198**, **199**
Gyrocotyle, **256**, **258**, **283**
Gyrodactylidæ, **253**
Gyrodactylus, **254**, **273**

H

HABITS—See Ethology
Hæmadipsa, **504**, **510**
 Hæmal system, **373**
 Hæmatochrome, **70**, **75**
Hæmatococcus, **74**, **75**
 Hæmerythrin, **486***
 Hæmocele, of Crustacea, **514**, **578** :
Peripatus, **608** : Insecta, **625**
 Hæmocyamin, **541**
Hæmoflagellata, **74**
 Hæmoglobin, **30**, **36**
Hæmopsis vorax, **510**
Hæmosporidæa, **84*** : Characteristic features, **88**, **89**
Haliocystus, **176**
Haliotidæ, **714**
Haliotis, **717**, **724**, **725**, **726**
Halistemma, **159**, **160**, **161**, **162**, **163**, **167**
Halistemma tergestinum, **160**, **162**
 Halteres, **625**
Hæmingia, **479**, **482**
Hærtæ, **193**, **195**, **200**
 Harvest-men, **645**, **649**
Hæstigerina, **55**, **56**
 Haversian canals, **28***, **29**
 Head, **43***
 Head-germs, **509***
 Head-kidneys, **441**
 Head-lobes, of *Astacus*, **554** : of *Fasciola*, **237***
 Heart, **36***
 Heart—See Vascular system
 Heart-urchins, **403***, **408**, **413**, **414**
 Hectocotylization, **739**, **769***
Heliopora, **193**, **201**, **205**, **206**, **208**
Heliozoa, **48*** : General structure, **58**,
59, **60**, **61** : Colonies, **59** : Skeleton,
59, **60** : Reproduction, **61** : Conjugation, **61**
Helix, **728**, **729**
Helix nemoralis, **722**
Hemipneustes radiatus, **414**
Hemiptera, **618***, **619**, **624**, **637**
 Hemisomes, **43***
 Hepatic cæca, **399**
 Hepato-pancreas, **35**, **537**
 Hermaphrodite, **40***
 Hermit-crabs, **555**, **574** : and *Hydractinia*, **146**, **147**
Herpobdella, **504**, **507**, **508**, **509**, **510**
Herpobdellida, **504***
Hesionida, **464**
Heterochærus, **267**
Heterocœla, **113***
Heterocotylea—See *Monogenetica*, **249**,
267
Heterocyenidæ, **227**, **229**
 Heterogamy, **41***, **305**
 Heterogeny, **272**, **282**
Heteromita, **73**
Heteromyaria, **680***

- Heteronemertini**, 288, 291*
Heteronereis, 430, 439
Heteropoda, 714*, 719, 720, 735, 736
 Heterotrichous, 94*, 96
 Hexacanth embryo, of *Tenia*, 246 :
 Cestodes, 275
Hexactinellida, 113*, 122, 124, 127
Hexactinia, 194, 198
Hexarthra, 322, 323, 325, 328
 Hinge-ligament, 665
 Hinge-line, 354, 665
 Hinge-teeth, 354, 665
Hippa, 555, 575, 589
Hippurites, 682, 683
Hirudinea, 429, 494 : Example, 494 :
 Distinctive characters and classification,
 503 : General organisation, 505 :
 Form and size, 505 : Setæ, 505 :
 Proboscis, 505 : Enteric canal, 505 :
 Blood-vessels, 505 : Respiratory organs,
 506 : Nephridia, 506, 507 :
 Nervous system, 507 : Sense organs,
 507 : Reproductive organs, 507 :
 Development, 508, 509 : Habits,
 distribution, &c., 509, 510, 512
Hirudinidæ, 504*
Hirudo, 503, 504, 507, 510
Hirudo australis, 494, 498, 499
HIRUDO MEDICINALIS, 494 : External
 characters, 494, 495 : Body-wall,
 496 : Muscular system, 496, 497 :
 Alimentary organs, 497, 498 : Ex-
 cretory system, 498, 499, 500 : Blood-
 system, 500, 501 : Nervous system,
 501 : Sense organs, 501, 502 : Re-
 productive organs, 502, 503 : De-
 velopment, 503 : Systematic posi-
 tion, 504
HIRUDO QUINQUESTRIATA — See **H.**
MEDICINALIS
Hirudo sanguisuga, 510
 Histology, 3*
Histriobdella, 330, 331, 332, 512
 Holarctic region, 9*
 Holoblastic segmentation, 23*
 Holophytic nutrition, 67*, 70, 75, 80
Holothuria—See Sea-cucumber
 Holothurian—See *Colochirus*
Holothuroidea : Example, 393 : Dis-
 tinctive characters and classifica-
 tion, 404 : General form, 407 : Modi-
 fications of form, 414 : Cœlome, 416 :
 Ambulacral system of vessels, 416 :
 Blood-vascular system, 417 : Hæmal
 system, 418 : Axial organ, 419 :
 Enteric canal, 419 : Respiratory
 trees, 419 : Cuvierian organs, 419 :
 Nervous system, 420 : Reproductive
 organs, 420 : Development, 421 :
 Ethology, 424
 Holotrichous, 91, 94*, 97
 Holozoic nutrition, 67*, 70, 80
Holomogaster, 253
Homarus, 555, 585
Homocœla, 113*
 Hood, 756*
 Hook-headed worms, 293
Hoplocarida, 555*
HORMIPHORA PLUMOSA, 208 : External
 characters, 208, 209 : Enteric sys-
 tem, 210, 211 : Cell-layers, 212, 213 :
 Nervous system, 213 : Sense organs,
 213 : Reproductive organs, 214 :
 Development, 214, 215, 216, 217 :
 Systematic position, 218
 Host, of parasite, 86 : intermediate, 89
 House-flies, 602, 619
 Hyaline cartilage, 28*
Hyalonema, 122, 127
Hyalosphenia, 49
 Hybrids, 2*
 Hydatids, 278*
Hydatina, 322, 324
Hydra, 134, 147, 148, 153, 166, 167, 258
Hydractinia, 145, 146, 148, 149, 166
 Hydranths, of *Obelia*, 130*, 149
 Hydrocœle, 383
Hydrocorallina, 143*, 156, 157, 158,
 159, 166
Hydroctena, 225
 Hydroids, naked-budded, 144* :
 covered-budded, 144*
Hytropialus, 634, 635
 Hydrophyllia, of Halistemma, 160, 162*
 Hydrohiza, 130*
 Hydrospires, 405*
 Hydrotheca, of *Obelia*, 130*, 131, 166
Hydrozoa, 129* : Example, 129 : General
 structure and classification, 141 :
 Alternation of generations, 141 :
 Systematic position of example, 143 :
 General remarks on, 166
Hydrula, 140, 141*, 153, 227
Hymenoptera, 621*, 624, 626, 627, 631,
 634, 637
Hyperia, 554
 Hypoblast, 24*
 Hypodermic impregnation, 327, 508
 Hypopharynx, 627
 Hypostome, of *Obelia*, 130*
 Hypotrichous, 94*, 96

I

- ICHNEUMONS**, 621, 636
Idmonea, 340
Idotea, 554
Illoricata, 322*
 Imaginal discs, 635
 Imago, 634
 Impregnation, 21*
 Impregnation, hypodermic, 327, 508
Inarticulata, 359*, 360, 361, 362
 Incurrent canals, of Sponges, 108, 109*,
 110, 118

Ineus (of Rotifera), 319*
 Individual of the first order, 167*
 Individual of the second order, 167*
 Individual of the third order, 167*
 Individual differences, in *Nereis dumerilii*, 439
 Individual variations, 2*, 114, 439
 Individuation, in Hydrozoa, 167
 Inequilateral valves, 682*
 Infundibula, of *Aurelia*, 173*
 Infundibular canal, 212*
Infusoria, 46*: Example, 90: Classification, 93: Systematic position of example, 93
 Infusoriform embryos, of Dicyemidæ, 228, 229*
 Inhalant pores, 107, 118
 Inhalant siphon, 604
 Ink-sac, of *Sepia*, 744
Insecta, 514, 602*, 660, 661, 662: Example, 603: Distinctive characters and classification, 615: Systematic position of the example, 621: General organisation, 621: Exoskeleton, 621, 622: Head, 622: Thorax, 622: Abdomen, 623: Appendages of head, 622, 623, 624: Appendages of thorax, 624: Abdomen, 625: Hæmocoelæ, 625: Fat body, 625: Digestive system, 626, 627: Malpighian tubes, 627: Tracheal system, 627: Blood-vascular system, 627: Nervous system, 628, 629: Organs of special sense, 629, 630: Luminous organs, 630: Production of sounds, 630: Reproductive organs, 631: Eggs, 632: Development, 632, 633, 634, 635: Metamorphosis, 634: Mode of life, 636: Distribution in time, 637
Integripalliata, 678*
 Integripalliate, 681*
 Integument—See Body-wall
 Inter-filamentar junctions, 670
 Inter-lamellar junctions, 669
 Inter-mesenteric chambers, 186*
 Internodes, of Siphonophora, 161
 Inter-radius, 139*
 Interstitial cells, of *Obelia*, 133
 Intertentacular tube, 344
 Intestinal cæca, 375, 380*
 Intestine, 489*
 Introvert, of Polyzoa, 334: *Sipunculus*, 484: Sipunculoidea, 488: Triton, 705: Gastropoda, 724
 Invagination, 24*
 Iridocytes, 741*
 Iris, 40, 750*
 Irritability, 11*
Isomyaria, 680*
Isopoda, 554*, 569, 570, 571, 572, 578, 581, 582, 587, 660
Isoptera, 617*

J

J
JAWS, 616
 Jaws, 33
 Jelly-fish, Common (*Aurelia aurita*), 167
 Jelly-fishes, 129
 Johnston's organs, 630*
 Jurassic, 7

K

K
KARYOGAMY, 61, 78*
 Karyokinesis, 18
 Keber's organ, 672, 688
 Kidneys—See Excretory system
 Kinetonucleus, 72*, 74
 King-Crabs, 637, 646, 650, 651
 Kingdom, 5*
Koonunga, 553
Kraussina, 360
Krohnna, 310

L

L
LABIAL PALPS, 605: of Pelecypoda, 668
 Labium, 605
 Labrum, 604: of *Apus*, 516: of *Astacus*, 529: of *Periplaneta*, 604: of Scorpion, 639
Labyrinthula, 67
 Lacinia, 605
Lacrymaria, 96
 Lacteals, 35
 Lacunæ (bone), 28*
 Lacunar system, 373
Lagenæ, 54
 Lamellæ (of bone), 28, 29
Lampetia, 214, 219
 Lamp-shells, 353
 Lancet plate, 405
 Land-snails, 715
 Lantern cœlome, 392
Laomedæa, 140
 Lappets, of Sea-anemone, 185
 Larva, of *Desor*, 290
 Larval membranes, of *Periplaneta*, 613*
 Larval organ, 353
 Lateral plane, 210*
Latreillia, 576
 Laurentian, 4
 Laurer's canal, 240
Lavrania, 88
 Leaf-insects, 617, 621
Leda, 677
 Leech—See *Hirudo*
 Leeches—See *Hirudinea*
 Lemnisci, 308*
Lemnobdella—See *Hirudo*
 Lens, 40—See Eye
Lepas, 551, 563, 564

- Lepas anatifera*, 563, **564**
Lepas fascicularis, 583
Lepidoptera, 620*, **624**, 625, 632, 634, 635, 637
Lepidurus—See *Apus*
Lepidurus kirki, **516**, **520**
Lepisma, **616**
Leptocheilia, 553
Leptochone, 466
Leptodiscus, 81
Leptodora, 550, **557**, 583
Leptolinæ, 142*: General structure, 143, **144**, **145**, **146**: Perisarc, 143: Medusæ, **144**, **145**: Cœnosarc, 146: Polypes, 149: Reproductive zooids, 149: Development, 152, **153**
Leptomedusæ, 142*, 144, 146, 149
Leptostraca, 552*, **566**, 581
Lernæa, 551, **561**, 563
Lestæira, **561**, 563
Leucilla conveza, **118**
 Leucocytes, 30
Leucodore, 207
 Lice, 619, 625, 636
Ligula, 256, **257**, 283
Ligula, 605*
Lima, 678, 685
Limax, **719**, **723**
Limnæus, **726**
Limnetis, 550, **557**
Limnoddella—See *Hirudo*
Limnociuida, 166
Limnocoidium, 166
 Limpets, 702, 713, **723**—See *Patella*
Limulus, **650**, **651**, **654**, **655**, 656, 660
Lineus, 229
 Lingua, 627
 Lingual ribbon, 708
Linguatulida, 657, **658**, 659, 661
Lingula, 359, **360**, **361**, 362, 364
 Linin, 17*
 Linnæus, 1, 3
 Liquid tissues, 30
 Lithite, 136*
 Lithites, of *Aurelia*, 172
Lithobius forficatus, **599**
Lithocircus annularis, **62**
 Lithocysts, **136***
 Littoral forms, 8*
 Liver, 35*
 Liver-Fluke—See *Fasciola hepatica*
 Liver-pancreas, 35
Lobata, 218*, **220**, 223
Lobosa, 48*, **49**: General structure, 48, **49**: Skeleton, **49**
 Lobsters, 555, 572, 585
 Locomotion, of *Amaba*, 12, 46: Heliozoa, 59: *Euglena*, 69: Flagellata, 72: Choanoflagellata, 80: Sporozoa, 82: *Paramacium*, 92: Tentaculifera, 101
 Locomotor rods, 313
Locusta, **617**
 Locusts, 514, 616, **617**, 621, 630
Lokmanella, 231
Loligo, 772, **774**, **776**, **777**, **778**, 779
Loligo vulgaris, **769**
Lophogaster, 553
Lophomonas, 95, **96**, 105
 Lophophore, 333, 334, 355, **361**
Lophopus, **344**
 Lorica, of Ciliata, 97: Flagellata, **73**, 75: Choanoflagellata, **79**, 80: Tentaculifera, 102: Rotifera, 317
Loricata, 322*, 323
Loxosoma, 341, 347, 348
Lucernaria, 175, 176, **177**
Lucernarida—See *Stauromedusæ*, 175
Lucifer, 555, 584
Lucina, 687
Lumbricidae, 456*
LUMBRICUS, 443: General external features, 443, **444**: Body-wall, 445, **446**: Setæ, **445**: Setigerous sacs, 445: Enteric canal, 446, **447**: Vascular system, 448: Nervous system, **449**: Organs of excretion, 449, **450**: Reproductive organs, 450, **451**: Development, 452, **453**: Systematic position, 456
Lumbricus rubellus, 471
Lumbricus trapezoides, 471
 Luminous organs, 630
 Lung, 36*: of Scorpion, 642: of Pulmonata, 724
 Lymph, 30*
Lysophiuræ, 403*

M

- MACHILIS**, 616
Macrobdella valdiviana, 505
Macrobiotus hufelandi, **658**
Macrura, 555*, 586, 587, 588
 Macula acustica, 750
Madrepora, **204**, 205
Madreporaria, 193*, 195, **196**, 198, 202, **204**, 205, 207, 224
 Madreporic, **204**, 205, 207
 Madreporic canal, 376, 391, 394
 Madreporite, of Starfish, 369, 410: of Sea-urchin, 389
MAGELLANIA, Shell, 353, **354**: Body, 355, **356**: Mantle-lobes, 355: Mantle-cavity, 355: Lophophore, 355, **356**, **357**: Food-groove, 355: Digestive organs, 355, 356: Body-wall, 357: Muscular system, **357**: Cœlome, 358: Blood system, 358: Excretory organs, 358: Nervous system, **358**: Reproductive organs, 358: Position of example, 359
Magellania flavescens, 353, **354**
 Maggot, 635*
Maia, 555, **581**, **584**

- Malacocotylea**, 249—See Digenetica
Malacostraca, 552*, 556, 566, 578, 579, 581, 582, 586
 Malaria parasites, 88, 89
 Malleus (of Rotifera), 319
Mallophaga, 618*
 Malpighian tubes, 601, 609 : of Scorpion, 641 : of Arachnida, 652 : of Tardigrada, 659
 Mandibles—See Appendages
 Manducation, 425*
Mantidiv, 621
 Mantle, of *Anodonta*, 663, 666 : Pelecypoda, 680 : Amphineura, 694 : *Triton*, 706 : Gastropoda, 722 : Scaphopoda, 737 : *Sepia*, 741 : *Nautilus*, 759
 Mantle-groove, 363
 Mantle lobes, 355
 Manubrium, of Medusæ, 130, 135 : of *Obelia*, 131 : of *Brachionus*, 319
 Marginal lappets, of *Aurelia*, 168, 169*, 178
 Marginal sense organs, 136*
 Marginal tentacles, of *Aurelia*, 168, 169*
 Marine Annelids, 429
 Mastax of Rotifera, 319
Mastigamæba, 72, 73
 Mastigophora, 45* : Example, 69 : Classification, 71 : General organisation, 71 : Systematic position of the example, 71
 Matrix of connective tissue, 27*
 Maturation, 20*, 22
 Maxilla—See Appendages
 Maxillary palp—See Appendages
 Maxillipeds—See Appendages
 Maxillulæ, 623*
 May-flies, 618
 Measly pork, 306
Mecoptera, 621*
 Medulla, of *Actinosphærium*, 58, 59 : *Monocystis*, 82 : *Paramæcium*, 90, 91
 Medullary sheath, of Nerve-fibre, 30*, 31
 Medusa-buds, of *Obelia*, 130
 Medusæ, of *Obelia*, 135, 136
Megadrili, 455*, 456
 Megagametes, of *Flagellata*, 79* : Sporozoa, 87, 88, 89 : Ciliata, 100, 101
 Megagametocyte, 87, 88
 Megalæsthetes, 699
 Megalopa stage, 585
 Megameres, 700, 730 : of Ctenophora, 215, 216 : of Polyclad, 268, 269 : of *Chiton*, 700 : of Gastropoda, 730
 Meganucleus, of Dinoflagellata, 81 : *Paramæcium*, 90, 91, 95 : of Ciliata, 95
 Megaspheric forms, 56, 57
 Megaspores, of Radiolaria, 65
 Megazoid, of *Vorticella*, 98, 99
Meleagrina, 678, 692
Meleagrina margaritifera, 692
Melicerta, 321, 323, 324, 325
Melolontha, 628
 Membranes, 26
Membranipora, 340, 346
 Mentum, 605
 Meridional canal, 212
 Meroblastic segmentation, 23*
 Merogony, 23*
Merozoa, 249*—See Polyzoa
 Merozoite, 86*, 87, 88
 Mesenchyme, 382
 Mesenteric filaments, of Sea-anemone, 186* : of *Flabellum*, 203
 Mesenteries, of Sea-anemone, 180*, 182, 185, 186, 190, 191 : Arrangement in Actinozoa, 196
 Mesenteron, 186, 640*
 Mesoblast, 24*
 Mesoderm, 24*, 216
 Mesoderm bands, of *Ascaris*, 304 : of *Periplaneta*, 614
 Mesogloæa, 111*, 112 : of *Obelia*, 132*
Mesonemertini, 291*
 Mesopodium, 706, 719
 Mesosoma, 638*
 Mesostomum, 267
 Mesothorax, 606
 Mesotrochal, 474*
Mesozoa, 227
 Messmateism—See Commensalism
 Metabolism, 13*
Metacrinus interruptus, 415
 Metagenesis, 41* : of Foraminifera, 57, 58 : *Obelia*, 141 : Leptolinae, 152 : Trachylinae, 156 : *Aurelia*, 172 : Liver-Fluke, 240 : *Tania*, 246 : Platyhelminthes, 270 : Nematoda, 304
 Metameres, 43*, 510
 Metamerism, 510, 511
 Metamorphosis, of Trachylinae, 156 : Sea-anemone, 191 : Platyhelminthes, 268 : Nemertinea, 290 : *Phoronis*, 351, 352 : *Asterina*, 381 : Echinodermata, 421 : *Antedon*, 423 : Chaetopoda, 475 : *Apus*, 525 : Crustacea, 582 : Insecta, 634
 Metamorphosis, retrogressive—See Degeneration
Metanauplius, 526
Metanemertini, 291*
 Metapodium, 706, 719
 Metathorax, 606
 Metazoa, 20*, 106
 Metentera, 186*
 Micræsthetes, 699
Microdrili, 455*, 463
 Microgametes, of *Flagellata*, 79* : Sporozoa, 86, 87, 88 : Ciliata, 100, 101
 Microgametocyte, 88
Microgromia, 51, 52

- Microhydra*, 149, 166
 Microlethical egg, 217
 Micromeres, of Ctenophora, **215**, 216 :
 of Polyclad, 269 : of *Chiton*, 700 : of
 Gastropoda, 730
 Micronucleus, of Dinoflagellata, 81 : of
 Ciliata, 95 : of *Paramoecium*, **91**, **92**
 Micropyle, **22** : of Cephalopoda, 775
 Microspheric forms, 56, **57**
 Microspores, of Radiolaria, **65**
Microstomum, **278**
 Microzooid of *Vorticella*, **98**, **99**
 Miescher's corpuscles, 90*
 Migration of parasites, 280*
Miliola, **53**
Millepora, 156, **158**
Millepora alvicornis, **157**, **158**
 Millipedes, 514, 598
Minyas, **200**, 224
 Miocene, 7
 Miracidium, 240*
 Mites, 514, 637, 646, 649, 652, 656
 Mitosis, **18***, 19
 Mitotic division—See Mitosis
Modiola, **680**, 685
 Mollusca, 663* : General remarks, 780
 Molluscoida 333* : mutual relation-
 ships of the classes, 365
 Monaxonida, 113*
 Mongrels, 2*
Moniezia, 284
 Monocyclica, 405*
 MONOCYSTIS AGILIS, **82**, **83** : Systematic
 position, 84
 Monœcious, 40*
 Monogentica, 249*, 253, **254**, 260,
 262, 263, 264, 268, 273, 279, 282,
 283
 Monomyaria, 680*
Monosiga, 79
Monotus, **251**
 Monozoa, 249*
 Morphology, 3*
 Morula, 24*
 Moruloidea, 227*
 Mosquitoes, 619, 636
 Mother-cyst, 278
 Mother-of-pearl, 666
 Moths, 620
 Mouth papillæ, 369*
 Movable cheek, **589**, 590*
 Mulberry body, 24*
 Müller's larva, 270
 Multicellular, 20*
 Multicellular gland, 26*
Multicilia, 95, **96**
 Multiple fission, of *Euglena*, 71
Murex, 725, **727**
 Muscle, striated, 29*, **30** : non-striated,
 29*, **30**
 Muscle processes, *Hydra*, 148
 Muscles, 37*, 38
 Muscular fibres of Sponges, 112
 Muscular system, of *Aurelia*, 171 : Sea-
 anemone, **184**, 187 : *Magellania*,
 357 : Brachiopoda, 362 : *Hirudo*,
496, 497 : *Apus*, 519 : *Astacus*, 533,
534 : Crustacea, 578 : *Periplaneta*,
607 : *Anodonta*, 667 : Pelecypoda,
 679
 Muscular tissue, 29*, **30**
 Mushroom coral, 203
 Mussels, 663
Mya, 678
Mya arenaria, **680**
 MYCETOZOA, 45* : Example, **68**, 69 :
 Sporangium, **68**, 69 : Capillitium, **68**,
 69 : Spores, **68**, 69 : Flagellula, **68**,
 69 : Plasmodium, **68**, 69 : General
 remarks, 69 : *Protomyxa*, 69
 Myomeres, of *Apus*, 519
 Myonemes, 82*
Myosoma, **347**
 MYRIAPODA, 514, 598*, 660, 661, 662 :
 Distinctive characters and classifica-
 tion, 598 : General organisation, 600 :
 External features, 600 : Integument
 and Body-wall, 600 : Alimentary
 canal, 601 : Heart, 601 : Respiratory
 system, 601 : Nervous system,
 601 : Reproduction, 601 : Ovum,
 601 : Fossil remains, 602
Myriothela, **144**, **148**, **149**
 MYSIDACEA, 553*, 568, 579, 582, 584,
 588
Mysis, 553, **567**, 584
Mytilus, 678, 679, 685, 686, 687, 691
Mytilus edulis, 679, **684**
Mytilus latus, 679
Myxidium lieberkühni, **89**, 90
Myxobolus mülleri, **89**
 MYXOSPONGIÆ, 113*, 121, 126
 MYXOSPORIDEA, 90* : Characteristic
 features, **89**
Myzostoma, **478**, **479**
 MYZOSTOMIDA, 429, 477*, **478**, **479**

N

- NACRE, 666*
Nais, 475
 Narcomedusæ, 142*, **155**, 156
 Natural History, 1*
 Nauplius, **525**, 526
Nausithoe, **179**
 Nautiloids, 663, 767
Nautilus macromphalus, 757, **766**
 NAUTILUS POMPILIUS, 754 : Shell, **754** :
 External characters of soft parts,
 755 : Mantle and mantle-cavity, 759 :
 Enteric canal, 761 : Cœlome, 761 :
 Heart and circulation, 761 : Renal
 organs, 763 : Nervous system, 764 :
 Sense organs, 765 : Reproductive
 organs, **765** : Systematic position, 767

- Nearectic region, 9*
- Nebalia*, 552, 566, 567
- Nebeliacea**, 552
- Neck, of cockroach, 603
- Nectocalyx, 161
- Nectonema*, 299, 300, 301, 302, 303
- Needham's sac, 753*, 765
- Nekton, 8*
- Nemathelminthes**, 293*: Appendix, 313: Affinities and relationships, 315
- Nematocyst**, 81*, 89, 90, 97, 133, 134*
- Nematoda**, 292*: Example, 292: External characters, 293: Body-wall, 293, 294: Digestive organs, 294, 295: Body cavity, 295: Excretory system, 296: Nervous system, 296, 297: Reproductive organs, 296, 297: Development, 297, 298, 303, 304: Distinctive characters and classification, 298: General organisation, 299: Life-history, 304
- Nematogene**, 228, 229*
- Nematoidea**, 299*, 301, 302
- Nematomorpha**, 299*, 300, 302
- Nemertinea**, 283, 284*: General features, 284, 285, 286, 288, 289: Body-wall, 285, 286, 288: Digestive canal, 286: Blood-vascular system, 286, 287: Excretory system, 286, 287: Respiration, 287, 288: Nervous system, 286, 288, 289: Cerebral organs, 286, 289: Eyes, 289: Statocysts, 289: Reproductive system, 289: Development, 290: Distinctive characters and classification, 290
- Neomenia*, 694, 695, 698, 699
- Neotropical region, 9*
- Nepheleis*, 504
- Nephridiopore, 438, 445, 494
- Nephridium, 429, 437*, 438, 449, 450, 467, 468, 487, 499, 500, 672: provisional, 469
- Nephrostome, 358, 438, 449, 467
- Nereidae*, 456*, 477
- Nereidiformia**, 456*
- NEREIS**, External features, 430, 431: Enteric canal, 432: Coelome, 432: Body-wall, 433: Vascular system, 434, 435: Nervous system, 436: Sense organs, 437: Excretory organs, 437, 438: Reproductive organs, 438: Individual variation, 439: Development, 440, 441, 442, 443: Systematic position, 455
- Nerilla*, 492
- Nerve-cell, 30*, 31
- Nerve-fibres, 30*, 31
- Nerve ganglia, 38
- Nerve pentagon, 372
- Nervous system, 15, 30, 38*, 39: *Obelia*, 133: *Leptolinae*, 151: *Aurilia*, 171: *Tealia*, 190: *Hormiphora*, 213: *Planaria*, 234, 235: *Fasciola*, 238: *Tania*, 244: Platyhelminthes, 261, 262, 263: Nemertinea, 288, 289: *Ascaris*, 296, 297: Nematoidea, 302: Acanthocephala, 308: Chaetognatha, 311, 312: *Brachionus*, 320: Rotifera, 320, 327: Dinophleia, 330: Gastrotricha, 330: Polyzoa, 344: Endoprocta, 347: *Phoronis*, 350: *Magellania*, 358: Brachiopoda, 362: Starfish, 372: Sea-urchin, 390: Holothurian, 394: *Antedon*, 400: Echinodermata, 420: *Nereis*, 436: *Lumbricus*, 448, 449: Chaetopoda, 465, 466: Myzostomida, 478: Echiurida, 480, 481: *Sipunculus*, 486, 487: Sipunculoidea, 486, 489: Archannelida, 491, 492: *Hirudo*, 501: Hirudinacea, 507: *Apus*, 522, 523: *Astacus*, 541, 542: Crustacea, 581: *Peripatus*, 594: Myriapoda, 601, 610, 611: *Periplaneta*, 610, 611: Insects, 628, 629: *Scorpio*, 641, 642: Arachnida, 653, 654: Mussels, 673: Pelecypoda, 688, 689: Amphineura, 698, 699: *Triton*, 710, 711: Gastro-poda, 725, 726: Scaphopoda, 737: *Sepia*, 745, 746, 747, 748, 749: *Nautilus*, 762, 764: Cephalopoda, 774
- Nervous tissue, 30*
- Nervures, 625*
- Neuraxis, 30*, 31
- Neurolemma, 30*, 31
- Neuronephroblast, 508*
- Neuropodium, 431*, 458
- Neuroptera**, 618*, 625, 632, 637
- New Zealand region, 9*
- Nicotthoe*, 561, 562
- Nidamental gland, 753*
- Noah's Ark shell, 678
- Noctiluca*, 81
- Nodes, of Siphonophora, 161
- Nodosaria**, 54
- Nomenclature, binomial, 1*
- Non-contractile vacuoles, 11*, 62, 95, 96
- Noteus*, 324
- Notholca**, 324
- Notommata werneckii*, 328
- Notopodium, 431*, 458
- Notostraca**, 550*
- Nuchal cartilage, 742
- Nuchal organs, 437*
- Nuclear membrane, 17*, 18, 82
- Nuclear sap, 17*
- Nuclear spindle, 18, 19*
- Nuclearia**, 60
- Nucleolus, 18*, 20, 82
- Nucleus, 11*, 15, 17, 20, 21
- Nucula*, 677, 680, 683, 684, 685, 686, 688, 689, 692, 693
- Nudibranchia**, 715*, 719, 723, 724, 736
- Nummulites**, 54

Nyctiphanes, 554

Nyctotherus, 94, 96, 97

Nymphon hispidum, 657

O

OBELIA, General structure, 129, 130, 131: Microscopic structure, 132, 133: Medusæ, 135, 136, 137: Comparison of polype with medusa, 137, 138, 139: Reproduction, 139: Development, 140: Systematic position, 143

Ocellular muscle, 342

Ocelli, 143, 172

Octopoda, 663, 767*, 768, 769, 770, 773, 780

Octopus, 768, 770, 772, 773

Octorchandra, 150

Ocular plates, 388, 389

Odonata, 618

Odontophore, 702, 707, 708, 709

Œsophagus—See Digestive system

Oikomonas, 73, 75

Olfactory organs, 39*

Olfactory pits, 172*

Oligochaeta, 455*, 457, 460, 461, 462, 463, 464, 466, 467, 468, 469, 470, 471, 475, 476, 477

Olynthus, 117

Ommatidium, 523*, 524

Oncidium, 727, 735

Oniscus, 554, 569, 572

Onychophora, 515, 591*, 661—See *Peripatus*

Oœcium, 334

Ookinete, 89*

Oosperm, 23*

Oostegites, 570*

Oostegopod, 519*

Ootype, 239, 240

Opalina, 95, 100

Opalinopsis, 96

Operculum, of Radiolaria, 62*, 64: Ciliata, 97, 98: Gastropoda, 704*, 705, 720

Ophioglypha, 411

Ophiuroidea, 368, 402*: Distinctive characters and classification, 402*: General form and symmetry, 406, 407, 408: System of plates, 409: Modifications of form, 410, 411, 412: Cœlome, 416: Ambulacral system, 417: Blood-vascular system, 417, 418: Hæmal system, 418: Axial organ, 419: Enteric canal, 419: Nervous system, 420: Reproductive organs, 420: Development, 422, 423: Ethology, &c., 425, 426

Ophrydium, 97, 99

Ophryodendron, 102

Ophryoglena, 96

Opisthobranchia, 714*, 718, 724, 725, 735

Opisthgoneata, 599*, 602, 661

Opisthorchis sinensis, 280

Optic gland, 750

Optic nerve-fibres, 750

Optic vesicle, 779

Oral arms, 169*

Oral surface, 369*

Oral tentacles, 151, 413

Orchestia, 554, 569, 579

Order, 4*

Organ of Bojanus, 672*: of Owen, 758*: of van der Hoeven, 758*: of Valenciennes, 759

Organic evolution—See Evolution

Organism, 1*

Organ-pipe Coral, 193

Organs, 31*

Oriental region, 9*

Orobdella, 504

Orthoceras, 780

Orthonectida, 227, 229, 230, 231

Orthoptera, 616*, 621, 624, 625, 637

Orthopteroidea, 616*

Oscarella, 118

Oscaria, 116

Oscillatoria, 74

Oscular sphincter, 112*

Osculum, 107*

Osphradium, 673*, 674, 712, 774

Ossicles, 368*

Ostia, 107*, 110, 521

Ostium, 186*

Ostracoda, 550*, 558, 559, 578, 579, 581, 582, 586, 587

Ostrea, 678, 680, 683, 688, 690, 691

Otocyst, 40*, 467, 673, 674, 689

Ovariole, 612*, 631

Ovary, 40*

Ovicells, 345*

Oviduct, 40*, 240

Oviparous, 40*

Ovipositor, 594

Ovum, 20*, 21, 31

Owen, organ of, 758*

Oxeote spicules, 109, 111*

Oxygen, oxidation, 36, 37

Oxyuris, 302

Oysters, 663, 678, 680

P

PACHYCHALINA, 121

Pædogenesis, 42*, 223*, 632

Pagurus, 555, 574

Palæarctic region, 9*

Palæmon, 555, 573

Palæmonetes, 578

Palæodictyoptera, 637

Palæontology, 6*

- Palinurus*, 555, 572, 580, 585, 587
 Pallial complex, 715
 Pallial groove, 338
 Pallial line, 666*
 Pallial muscles, 667
 Pallial sinus, 358
 Pallium—See Mantle
 Palpi, 461
Paludicella, 340, 346
Paludina, 734
 Pali, 202*
Palythoa, 127, 195
 Pancreas, 35*
 Pancreatic juice, 35*
Pandorina, 74, 75, 76, 77
 Papillæ, 415*
 Paragastric cavity, 107*, 109
 Paragnatha, 517*, 535
Paramithrax, 586
Paramœba, 51
Paramœcidæ, 93
 PARAMÆCIUM, 90, 91, 92, 93 : Systematic position, 93
Paramœcium caudatum, 91, 92, 93
 Paramylum, 70*
Paranaspides, 553, 567
Paranephrops, 555
 Parapodium, 429, 430, 431, 458, 720
Paraseison asplanchnus, 322
 Parasitism, of *Amœba*, 51 : Protozoa, 74, 83, 84, 86, 89, 97 : Ciliata, 101 : Hydrozoa, 166 : Mesozoa, 227 : Rotifera, 328
Parazoa, 106
 Parenchyma, 233*, 259, 260, 301, 344
 Parenchyma muscle, 260
 Parenchymula, 123*
 Parthenogenesis, 21*, 41*, 282, 632
 Parthenogonidia, 78*
Parthenope, 576
Patella, 717, 723, 725, 726, 727, 729, 731, 732, 733, 734
Patellidæ, 713
Pauropoda, 598*, 601
Pauropus, 598, 600
 Paxillæ, 405
Paxillosa, 402, 410
Peachia, 200, 206
 Pea-crab, 586
 Pearl-mussel, 692
 Pearl-oyster, 678
 Pearls, 692
 Pébrine, 90*
Pecten, 678, 679, 682, 689, 690, 692
 Pectines, 640*
Pectinibranchia, 714*, 724
 Pedal gland, 706*, 720
 Pedal lobes, 178
 Pedal tentacles, 720
Petalion, 322, 323, 325, 328
Pedata, 404*, 425
 Pedicellariæ, 370, 374, 380, 387, 408
Pedicellina, 341, 347
 Pedipalpi, 638, 647, 648
Pedipalpida, 645*, 647, 648, 652, 653, 656
 Peduncle, 202*
Pelagia, 182, 183
 Pelagic species, 8*
Pelagohydra, 149
Pelagothuria, 414
Pelecypoda, 663 : Example, 663 : Distinctive characters and classification, 676* : General organisation, 679 : Adductor muscles, 679 : Shell, 680 : Siphons, 680 : Foot, 683 : Byssus gland, 685 : Gills, 685, 686, 687 : Digestive organs, 687 : Excretory organs, 688 : Circulatory organs, 688 : Nervous system, 688, 689 : Sense organs, 689 : Reproduction and development, 690, 691, 692 : General remarks, 692 : Mutual relationship, 693
 Pellicle, 90
Pelmatozoa, 404*, 425
Pelomyxa, 49
Peltoaster, 552, 565
 Pen, 772*
Penæus, 555, 584
 Penial setæ, 293, 299
Pennatula, 194, 195, 197, 202, 205
Pennatulacea, 194*, 195, 197, 202
Pentaceros, 420
 Pentacrinoid larva, 401*, 424
Pentacrinus, 401
Pentastomida—See Linguatulida
Pentastomum tænioides, 658
 Peptonephridia, 469*
 Peptones, 35
Peracarida, 553*, 586
 Perforate corals, 205*
 Pericardial sinus, 521*
 Perichondrium, 28*
Pericolpa, 178, 179
 Perihæmal system, 372*
 Periosteum, 29*
 Periostacum, 666*
PERIPATUS, 514, 591 : External features, 591, 592 : Body-wall and body-cavity, 592 : Enteric canal, 592, 593 : Circulatory system, 592 : Organs of respiration, 593 : Coxal and slime glands, 593, 594 : Nervous system, 594 : Nephridia, 594 : Reproductive organs, 594 : Development, 595, 596, 597 : Distribution, 597 : Relationships, 597
Peripatus capensis, 591, 592, 593, 594, 596, 597
Peripatus novæ-zealandiæ, 595
Periphyllo, 178
PERIPLANETA AMERICANA, 603, 604 : Head, 603, 604 : Neck, 605 : Thorax, 606 : Abdomen, 606 : Respiratory movements, 607 : Muscles, 607 :

- Hæmocœle, 698 : Digestive system, **608, 609** : Renal organs, 609 : Heart, 609 : Respiration, 609, **610** : Nervous system, 610, **611** : Organs of special sense, 611 : Reproductive organs, **611** : Development, **612, 613, 614, 615** : Systematic position, 621
- Periplaneta orientalis*, 603, **604, 605**
- Periproct, 386*
- Perisarc, **131, 132, 133**
- Peristaltic movements, 37*, 434
- Peristome, 94, 97, **98, 185*, 373*, 386***
- Peritomeum, 430*, 444, 460
- Peritoneum, 445*
- Peritrichous ciliation, 94*, **98**
- Perivisceral cavity, 432*
- Periwinkles, 663
- Perlidae*, 618
- Peromedusæ**, 179
- Per-radius, 139*
- Petaloid ambulacra, 413
- Petatus*, **154**
- Petrarca*, 551, 565
- Phacellæ, 171*
- Phacops fecundus*, **589**
- Phæodium, 62, **64**
- Phalangida**, 645*, 649, 651, 653
- Phanerocephala**, 454*, 456, 464, 472, 476
- Pharynx—See Digestive system
- Phasmoda*, 621, 637
- Pheronema carpenteri*, 122, **124**
- Philodina*, 321, **324, 327**
- Pholas*, 678, 682, 692
- Phoronida**, 333, 348, 353
- Phoronis*, **348, 349, 350, 351, 352**
- Phragmacone, 772*
- Phragmoceras*, 780
- Phreatoicus*, 554
- Phronima*, **571**
- Phrynus*, **647**
- Phylactolæmata**, 341*, 342, 343, 344, 345, 346
- Phyllocarida**, 552*, 566, 567, 579, 581, 586, 587, 588
- Phyllococe paretii*, **468**
- Phyllosoma, 585
- Phylogeny, 8*
- Phylum, 5*, 43*
- Physalia*, **163, 164**
- Physiology, 9*
- Phytoflagellata**, 75
- Pieris*, **620**
- Pigment, 70, 120
- Pilema*, **181**
- Pilidium, **290**
- Pill-bug, 572
- Pinacocytes, 120*
- Pinna*, 678, 685
- Pinnotheres*, 586
- Pinnules, 398*
- Pionosyllis elegans*, **472**
- Piscicola*, 504, 510
- Placenta, 597
- Placophora**, 694*, 697, 698, 699, 701, 702
- PLANARIA**, 233 : General features, 233, **234, 236** : Digestive system, 233, **234** : Water vessels, **234, 235** : Nervous system, **234, 235** : Reproductive system, 235, **236** : Systematic position, 249
- Planariidæ*, 249
- Plankton, 8*
- Planocera*, 269, 271
- Planorbis*, 241
- Planorbulina*, **54**
- Plant lice, 619, 632
- Planula, **140*, 153, 172, 173, 190**
- Plasma, of blood, 30
- Plasmodium, 31*, **68, 69**
- Plasmosome, 18*
- Plastin, 17*, 18
- Platyctenea**, 218*, **221, 222, 223**
- Platyhelminthes**, 233, 248* : Examples, 233, 236, 243 : Systematic position, 249 : General external features, 250 : Integument and muscular layers, 257, **259** : Parenchyma, **259** : Alimentary systems, 260, **261, 262** : Nervous system, **261, 262, 263** : Water-vascular system, 263, **264** : Reproductive organs, 264, 265, 266, **267** : Development, 268, **269, 270, 271, 272, 273, 274, 275, 276, 277, 278** : Asexual reproduction, **278** : Distribution, occurrence, and relationships, 279, 283 : Appendix, 284
- Platyopoda**, 714*, 715
- Pleopod, 530*
- Pleurobrachia*, 208
- Pleurobrachiidæ*, 218
- Pleurobranchia, **536, 537***
- Pleuron, 528*
- Pleurophyllidia*, **723**
- Ploima**, 322*, 323
- Plumatella*, 341, **342**
- Plumularia*, 149
- Pluteus, 392, 403, **422, 423**
- Pneumatophore, **160, 161***
- Podia, 370*, 413
- Podical plates, 606*
- Podobranchia, **536, 537***
- Podomere, 514*
- Podophrya*, 101, **102**
- Podura*, **616**
- Polar body, 21*, 22
- Polar plates, 213*
- Polian vesicles, **376, 377*, 391, 394, 417**
- Pollicipes*, 565
- Polyarthra*, 322, 323, **331**
- Polyclis*, **251**
- Polychæta**, 454*, 460, 461, 463, 466, 467, 468, 469, 470, 471, 472, 474, 475, 477

- Polycladida**, 248*, 251, 252, 253, 257, 258, 261, 262, 263, 265, 266, 268, 269, 270, 282, 283
- Polycolpa*, 155
- Polydora*, 477
- Polygordiidae*, 491
- Polygordius lacteus*, 491
- Polygordius neapolitanus*, 491, 492, 493
- Polykrikos*, 80, 81
- Polymorphism, 142*
- Polynesian region, 9*
- Polynoe*, 457, 459, 460
- Polynoe extenuata*, 459
- Polynoe setosissima*, 457
- Polynoidae*, 457, 470
- Polyæca*, 79, 80
- Polyophthalmus*, 466, 470
- Polype, 130*, 149
- Polyphemus*, 551, 558
- Polyphyletic group, 282*
- Polypodium*, 166
- Polyspermy, 21*
- Polystomatous, 182*
- Polystomeæ*, 253, 254
- Polystomella*, 57
- Polystomum*, 254, 273, 279
- Polytrochal larvæ, 474*
- Polyzoa**, 333*: Example, 334: Distinctive characters and classification, 340—See *Ectoprocta* and *Endoprocta*
- Polyzoa** (Cestoda), 249*
- Pontellina mediterranea*, 585
- Pontobdella*, 504, 505, 506, 507
- Porcellana*, 555
- Pore-membrane, 109, 110*
- Porifera**, Example, 106: Distinctive characters and classification, 112: General form and mode of growth, 115: Leading modifications of structure, 117: Histology, 120: Skeleton, 120: Reproduction, 122: Development, 122: Distribution, affinities, &c., 125, 226
- Porocyte, 110*, 123
- Poromya*, 678, 685, 686
- Porospora gigantea*, 86
- Porpua*, 164, 165
- Port-hole—See *Cinclides*
- Portuguese Man-of-War, 163
- Portunus*, 576
- Post-abdomen of Scorpion, 638
- Potamobiidae*, 556*
- Poterion*, 116
- Prawns, 572, 573
- Pre-abdomen of Scorpion, 638
- Priapuloidae*, 490
- Priapulid*, 490
- Primary axis, 42*, 210*
- Primitive ectoderm, 304*
- Primordial endoderm cell, 304*
- Primordial sexual cells, 304*
- Prismatic layer, 666
- Proboscis, 234
- Proglottides, 243*
- Progoneata**, 598*, 602, 660, 661
- Pro-legs, 635
- Proneomenia*, 694, 698
- Pronucleus, active and stationary, 93: male and female, 21*, 22, 23
- Pro-ostacum, 772*
- Propodium, 706, 719
- Prorocentrum*, 80, 81
- Prorodon*, 96, 97
- Prosclex, 247*
- Prosiphon, 771*
- Prosobranchia**—See *Streptoneura*
- Prosoma, 638
- Prosopyle, 109, 110*
- Prostate, 264, 266*, 471
- Prostomium, 430*, 444, 460
- Protamæba*, 49
- Protandrous, 302*
- Protective characters, 586
- Proteids, 16*
- Proteolepas*, 551, 565
- Proterospongia*, 79, 80, 127*
- Proteus Animalecule, 10
- Prothorax, 606
- Protobranchia**, 677*, 679, 686, 688, 693, 781
- Protoconch, 755*, 771
- Protodrilus*, 491, 492, 512
- Protohydra*, 148, 149
- Protomerite, 84, 85*
- Protomyxa*, 69
- Protonemertini**, 291*
- Protonemertidial system, 232*, 263
- Protoplasm, 11*, 15, 16*, 17
- Protopodite, 526*, 530, 531
- Prototroch, 316*, 441
- Protozoa**, 45
- Protozoæa stage, 584*
- Protractor muscle, 666
- Proventriculus, 609*
- Psammoclema*, 116
- Pseudoblastopore, 216*
- Pseudobonellia*, 479, 482
- Pseudogastrula, 125*
- Pseudo-lamellibranchia**, 678*, 680, 682, 693, 694
- Pseudo-manubrium, 156*
- Pseudo-metamerism, 251*
- Pseudopod, 10*, 45*, 46*, 47: of *Amæba*, 10*, 45*, 47
- Pseudo-scorpionida**, 645*, 646, 652, 653
- Psocidæ**, 617*
- Psocus fasciatus*, 617
- Psolus*, 414
- Psorosperms, 89
- Pteropoda**, 714*, 720, 721, 735
- Pterotrachea*, 721
- Pterygota**, 616*
- Pulmonary sac, 724*
- Pulmonata**, 715*, 719, 722, 724, 726, 728, 729, 730, 735, 736

- Pulsellum*, 736
 Pupa, of Cirripedia, 583: of Insects, 634
Purpura, 725
Pycnogonida, 657*, 658, 662
 Pygidium, 590*
 Pyloric caeca, 374, 375
 Pyrenoids, 75
 Pyriform organ, 338
 Pyriform sac, 767
Pyrula, 730
Pyxicola, 97
- Q
- QUADRULA**, 49
- R
- RACHIS**, 297*
 Radial canals, 108, 109*, 110, 118
 Radial symmetry, 42, 43*
Radiata, 426
 Radii, orders of, 138, 139
Radiolaria, 48*: General structure, 62: Central capsule, 62: Skeleton, 63: Colonial forms, 63: Reproduction, 63: Symbiosis, 65
 Radula, 708*
 Radular sac, 708*
 Rainey's corpuscles, 90*
Raphidiophrys 60
 Razor-fish, 692
 Receptacula ovarum, 452*
 Receptacula seminis, 452*
 Rectum, 489*
 Red coral, 193, 201, 207
 Redia, 242*
Regularia, 403*, 406
 Relationship, 6*
 Relationships, of Protozoa, 104:
 Sponges, 127, 226: Coelenterata, 226: Platyhelminthes, 282: Nematelminthes, 315: Rotifera, 328: Dinophylea, 330: Molluscoidea, 365: Echinodermata, 426, 490, 512: Sipunculoidea, 490, 512: Annulata, 510, 587: Crustacea, 587 *Peripatus*, 597, 662: Air-breathing Arthropoda, 597, 659: Pelecypoda, 693: Gastropoda, 736: Cephalopoda, 780: Mollusca, 780
 Relationships, diagrams of: of Protozoa, 105: Coelenterata, 227: Platyhelminthes, 283: Echinodermata, 428: Annulata and Trochelminthes, 513: Crustacea, 588: Arthropoda, 661: Pelecypoda, 693: Gastropoda, 736: Cephalopoda, 780
 Renal organs—See Excretory system
 Reproduction, Reproductive System, 15, 31, 32, 40, 41: *Anaba*, 14, 46, 47: Foraminifera, 56, 57, 58: Heliozoa, 61: Radiolaria, 63: Mycetozoa, 69: *Euglena*, 71: Flagellata, 76, 77, 78, 79: Choanoflagellata, 80: Dinoflagellata, 81: Cystoflagellata, 82: *Monocystis*, 82, 83, 85: Gregarinida, 86: Coccidiidea, 86: Haemosporidea, 89: *Paramoecium*, 92: Ciliata, 99: Tentaculifera, 103: Porifera, 122: *Obelia*, 139: Leptolinae, 149: Trachylinae, 155: Hydrocorallina, 159: Siphonophora, 163, 164, 165: *Aurelia*, 171: *Tealia*, 190: Actinozoa, 195: *Hormiphora*, 214: Mesozoa, 229, 230, 231: *Planaria*, 235, 236: *Fasciola*, 239, 240: *Tania*, 245, 246: Platyhelminthes, 264, 265, 266, 267, 268, 278: Nemertinea, 289: *Ascaris*, 296, 297: Nematoda, 302: Acanthocephala, 308, 309: Chaetognatha, 312: *Brachionus*, 320, 321: Rotifera, 327: Dinophylea, 331: *Bugula*, 336, 337: Ectoprocta, 345: Endoprocta, 347: *Phoronis*, 350, 351: *Magellania*, 358: Brachiopoda, 362: Starfish, 378, 379: Sea-urchin, 392: *Holothurian*, 396: *Antedon*, 401: Echinodermata, 420: *Nereis*, 438: *Lumbricus*, 450, 451, 452: Chaetopoda, 470, 471: Myzostomida, 478, 479: *Sipunculus*, 488: Sipunculoidea, 489: Archi-annelida, 492: *Hirudo*, 502: Hirudinea, 507, 508: *Apus*, 524, 525: *Astacus*, 542, 543: Crustacea, *Peripatus*, 594, 595: Myriapoda, 601: *Periplaneta*, 611, 612: Insects, 631: *Scorpio*, 643: Arachnida, 654, 655: Mussel, 674: Pelecypoda, 691: Amphineura, 699, 700: *Triton*, 712: Gastropoda, 728, 729: Scaphopoda, 737: *Sepia*, 752, 753: *Nautilus*, 765, 766: Cephalopoda, 774
Requienia, 682, 683
 Reservoir (*Euglena*), 70
 Respiration, 13*, 35
 Respiratory organs, 36*: Starfish, 369: Sea-urchin, 392: Holothurian, 396: Chaetopoda, 461: *Apus*, 518, 522: *Astacus*, 536, 537: Crustacea, 579: *Peripatus*, 593: Myriapoda, 611: *Periplaneta*, 609, 610: Insects, 626, 627: Scorpion, 642: Arachnida, 653, 654, 655: Mussel, 669: Pelecypoda, 685, 686: *Triton*, 706: Gastropoda, 722, 723: *Sepia*, 745: *Nautilus*, 759: Cephalopoda, 773
 Respiratory trees, 396*, 419
 Retina, 40*
 Retinal cells, 750
 Retinophore, 712*
 Retinula, 524*, 542, 712
 Retractor muscles, 666

Rhabdites, 257*
 Rhabditis-form, 304
Rhabdocœlida, 248*, 251, 252, 257, 260, 261, 262, 263, 264, 266, 267, 268, 271, 278, 279, 283
Rhabdogaster, 313
 Rhabdome, 524*
Rhabdomolgus, 414
Rhabdonema nigrovenosum, 304, 305
 Rhagon-type of Sponge, 119*
 Rhinophore, 765*
Rhipidodendron, 73, 76
Rhipidoglossa, 714*, 736
Rhizocephala, 552*, 565
Rhizopoda, 45*: Example, 46: Classification and general organisation, 47
Rhizostomæ, 176*, 181, 182, 224
Rhizota, 321*, 327
 Rhombogene, 229*
Rhopalura, 229, 230
Rhyneheta, 102
Rhynchobdellida, 504*, 505, 506, 507, 508
Rhynchodemus, 251
Rhynchonella, 359, 361
 Rhyncocœle, 285*
Rhyncota, 618*
 Ring-vessel, 264*
 Rock-lobster, 555
 Rock systems, 7
 Rocks, igneous and aqueous, 6*, 7*
 Rods of retina, 750*
 Rosette, 398*
 Rosette (Earthworm), 451
 Rosette plate, 409
 Rostellum, 243*
 Rostrum, 529*
Rotalia, 53
 Rotation, sense of, 40
Rotifer, 320, 321
Rotifera, 317*: Distinctive characters and classification, 321: External characters, 323, 324, 325: Digestive organs, 326: Excretory system, 327: Nervous system and Sense organs, 327: Reproduction and Development, 327: Ethology, 328: Affinities, 328
 Rotule, 389*
 Round-worms, 292—See Nematelminthes
Rugosa, 208*

S

SABELLA, 466
Saccamina, 54
Saccocirrus, 454, 466
Saccosoma, 480, 482
 Sacculi, 400*
Sacculina, 552, 565, 583, 584
Sagartia, 188, 189
Sagitta, 310, 311, 312, 313
 Sagittal plane, 210*

Sail, of Siphonophora, 164, 165
Salinella, 231
 Saliva, 34*
 Salivary glands, 34*
 Salivary receptacle, 608
Salmacina, 475
Salpingœa, 79
Saltatoria, 616, 621
 Sand-hopper—See *Orchestia*, 554
 Saprophytic nutrition, 71*, 74
Sarcocystidea, 84, 90
Sarcocystis, 90
 Sarcolemma, 29*
Sarcophaga, 629
Sarcoptes scabiei, 649
Sarsia, 145
 Scale-insects, 619, 632
 Scallop, 678
Scaphopoda, 663, 736*, 737, 738
Schistosomum hamatobium, 280
Schistosomum japonicum, 280
 Schizogony, 86*, 87, 88
Schizopathes, 199
 Schizopod-stage, 584, 585
Schizopoda, 586
Scirtopoda 322*, 323
 Sclerite, 548*
 Scleroblast, 111*, 120, 121, 124
 Sclerotic, 750
 Scolex, 243*, 275
Scolopendra, 599
Scolopendrella, 598, 600
 SCORPION—See BUTHUS
Scorpionida, 644*, 656, 659, 660
 Scorpion-flies, 621
 Scorpion-spiders, 645
 Scorpions, 514, 637, 656, 659, 660
Scrobicularia piperata, 681
 Scuta, 563, 564
Scutariclla, 253
Scutigera, 600, 601
Scutigereilla, 599
Scyllarus, 573, 574
Scyllis ramosa, 476
 Scyphistoma—See Scyphula
Scyphozoa, 129: Example, 167: Structure and classification, 175: Systematic position of example, 176: Additional remarks on, 183
 Scyphula, 174*, 175, 227
 Sea-anemones, 129, 183, 192, 194, 197, 198—See *Tealia*
 Sea-blubbers, 181
 SEA-CUCUMBER, External features, 393: Structure of body-wall, 394: Ambulacral system, 394: Nervous-vascular systems, 394: Celome, 394, 395: Enteric canal, 395, 396: Reproductive organs, 396: Development, 396: Systematic position, 406
 Sea-cucumbers, 404—See Holotheroidea
 Sea-fans, 193, 201

- Sea-firs (Sertularians), 144
 Sea-hares, 702
 Sea-mats, 333—See Polyzoa
 Sea-mice, 464
 Sea-mussel, 678
 Sea-pens, 194
 SEA-URCHIN, External features, 386, 387, 388: Corona, 388: Aristotle's lantern, 389, 390: Nervous system, 390, 391: Ambulacral system, 391: Enteric canal, 391, 392: Cœlome, 392: Blood-vascular system, 392: Reproductive organs, 392: Development, 392: Systematic position, 406
 Sea-urchins, 403*—See Echinoidea
 Secondary axis, 42*, 43
 Secondary ectoderm, 304
 Secretion, 26*
 Segment, 43*
 Segmental organ—See Nephridium
 Segmentation of oosperm, 23*
 Segmentation-cavity—See Blastocœle
 Segmentation-nucleus, 21*, 22
 Season, 328
Seisonida, 322
Selenaria, 340
Selenariidae, 342, 345
 Self-mutilation, 425
Semostomæ, 176*, 181, 182, 224
 Sense Organs, 29*: *Obelia*, 136: Traehylinæ, 154, 155: *Aurelia*, 171, 172: Cubomedusæ, 181: *Hormiphora*, 213: *Ctenoplana*, 221: *Tyalfiella*, 222: Platyhelminthes, 263: Nemertinea, 289: Chaetognatha, 311, 312: *Brachionus*, 320: Rotifera, 327: Starfish, 370: Sea-urchin, 388: *Nercis*, 437: *Lumbrius*, 448: *Sipunculus*, 487: *Hirudo*, 501, 502: Hirudinea, 507: *Apus*, 523, 524: *Astacus*, 542: Crustacea, 581, 582: *Peripatus*, 594: *Periplaneta*, 611: Insects, 629, 630: *Scorpio*, 643, 655: Arachnida, 653, 654, 655: Mussel, 673, 674: Pelecypoda, 689, 690: Amphineura, 698, 699: *Triton*, 712: Gastropoda, 726, 727: *Sepia*, 749, 750: *Nautilus*, 765: Cephalopoda, 774—See also Eyes, Auditory organs, Olfactory organs, Gustatory organs, Tactile organs, Osphradia
 Serse papillæ, 296, 485
 SERPIA, External features, 738, 739: Shell, 740, 741: Chromatophores, 741: Mantle-cavity, 741: Internal skeleton, 742: Alimentary system, 742: Ink-sac, 744, 769: Vascular system, 744: Cœlome, 745: Ctenidia, 745, 746: Nervous system, 745, 746, 747, 748: Sensory organs, 749, 750, 751: Excretory organs, 751, 752: Reproductive organs, 752, 753, 754: Systematic position, 767
Sepia cultrata, 738, 739, 740, 741, 742, 743, 746, 747, 748, 750
Sepiidae, 767*
 Septal funnel, 173*
 Septal neck, 755*
Septibranchia, 678*, 679, 680
 Septum, 202*
Serialaria, 340
 Serosa, 613*, 644
Serpula, 457, 462, 465, 468, 476, 477
Serpulida, 457, 461, 473, 475, 476
 Sertularians, 144
 Setæ, 428, 430, 431, 445: provisional, 363, 443
 Setigerous sac, 431*, 442, 443, 445, 446
 Sexual dimorphism, 40*
 Sexual generation, 141
 Shell, *Magellania*, 353, 354, 355: Brachiopoda, 360, 361: *Mussel*, 664, 665: Pelecypoda, 680: *Chiton*, 695, 696: *Triton*, 702, 703, 704: Gastropoda, 717, 718: Scaphopoda, 736: *Sepia*, 740, 741: *Nautilus*, 754, 755: Cephalopoda, 770, 771
 Shell-gland, 240, 515, 674, 776, 778: (*Apus*), 515*, 522*: (Crustacea), 581
 Shelly loop, 354*
 Ship-worm, 678
 Shrimp, 514, 555, 572, 573
 Sicula, 166*
Sigaretus, 720
Silicispongiæ, 125*
Silicoflagellata, 75
 Silver-fish, 616
Sinupalliata, 678*, 681, 690
 Sinupalliate shells, 681*
 Sinus, 541
 Siphon, 391, 419, 704
 Siphonal process, 704*
Siphoniata, 693
Siphonodentalium, 736
 Siphonoglyphæ, 185*
Siphonophora, 143*, 159, 160, 161, 162, 163, 164, 165, 166, 224
 Siphonozoid, 200*
 Siphons, inhalant and exhalant, 664*, 680
 Siphuncle, 754*
Sipunculoidea, 365, 484*, 511, 512: Example of the class, 484: Distinctive characters, 488: General organisation, 488: Body-wall, 488: Alimentary canal, 489: Blood-vascular system, 489: Nervous system, 489: Eyes, 489: Nephridia, 489: Reproductive organs, 489: Development, 489, 490: Distribution, Affinities, &c., 490, 512
SIPUNCULUS NUDUS, General external features, 484, 485: Body-wall, 485: Cœlome, 486: Blood-vascular system, 487: Alimentary canal, 486, 487: Nervous system, 486, 487:

- Nephridia and gonads, 487, 488 :
 Systematic position, 512
- Skeleton, 32* : Lobosa, 49 : Foraminifera, 55, 56 : Heliozoa, 59 : Radiolaria, 63 : Flagellata, 75 : Ciliata, 97, 98 : Porifera, 120 : Actinozoa, 200 : *Sepia*, 742 : Cephalopoda, 772, 773—See also Shell and Body-wall
- Skin, 32*—See Body-wall
- Slime glands, 591
- Slugs, 663, 715
- Snails, 663, 715
- Solarium*, 718
- Solecurtus strigillatus*, 682
- Solen*, 692
- Solenocytes, 331*, 351, 468
- Solenogastres**, 694*, 695, 696, 697, 698, 699, 700, 702, 781
- Solenomya*, 677
- Solpugida**, 645*, 647, 648, 651, 652, 653
- Somatoblast, 440
- Somatopleure, 614*
- Spadella*, 310
- Spadix, 758*, 759
- Spatangoidea**, 403*, 408, 413
- Species, 1*, 114*
- Specific name, 2*
- Sperm, 21, 31*
- Spermary, 40*
- Spermatidia, 337*
- Spermatogenesis, 31*
- Spermatozoon—See Sperm
- Spermiduct, 40*
- Sperm-morulae, 83*
- Spermothecæ, 303*, 452*
- Sperm-reservoirs, 471
- Sphæridia, 387*, 408, 412
- Sphæroma, 554
- Sphærophrya*, 102
- Spicules, 32*, 200, 361
- Spiders, 514, 637, 645, 648, 651, 653, 656
- Spinnerets, 649*
- Spinning-glands, 646, 649
- Spinules, 237*
- Spinulosa**, 402
- Spiral segmentation, 269*
- Spireme, 19*
- Spirifera*, 360, 361
- Spirilla*, 74
- Spirochaetes*, 74
- Spiroloculina*, 54
- Spirorbis*, 477
- Spirorbis levis*, 473
- Spirula*, 767, 771, 772
- Splanchnopleure, 614*
- Spongelia*, 121
- Spongilla*, 119
- Spongillidae*, 122, 126
- Spongin, 112*, 120, 122
- Spongin-blasts*, 122*
- Sporangium (Mycetozoa), 68, 69
- Spore, 41, 50*, 69, 82, 83, 85, 87, 88, 89, 90
- Spore formation, 41, 56, 61, 63, 67, 68, 69, 82, 83, 85, 86, 87, 89, 90, 99
- Sporocyst, 241*
- Sporogony, 86*, 87
- Sporosac*, 151*
- Sporozoa**, 46* : Example, 82 : Classification and general organisation, 83
- Sporozoites, 82, 83*, 85, 86, 87, 88, 89
- Springtails, 616, 625
- Squame, 531*
- Squammulina*, 53, 55
- Squids, 767
- Squilla*, 577
- Stæcharthrum*, 229
- STARFISH**. External characters, 368, 369, 370 : Transverse section of arm, 370, 371 : Vascular and nervous systems, 372 : Structure of disc, 373 : Body-wall and cœlome, 373 : Digestive system, 374, 375 : Ambulacral system, 375 : Reproductive system, 378, 379 : Development, 380, 381, 382, 383, 384, 385, 386 : Systematic position, 405
- Starfishes, 368—See Asteroidea
- Statoblasts, 346*
- Statocones, 689*, 765
- Statocysts, 263*, 289, 467*, 542*, 674, 689, 765*, 774
- Statalith, 263, 289, 467*, 689*
- Stauromedusæ**, 175*, 176, 177, 224
- Stelechopus*, 477
- Stenocyphus*, 176
- Stentor*, 94, 96
- Stephanoceros*, 321, 323, 324
- Sternal canal, 528*
- Sternaspis*, 460, 461, 464, 465, 468
- Sternaspis spinosa*, 461
- Sternum, 528*
- Stewart's organs, 416*
- Stichopoda*, 406
- Stichotricha*, 97
- Stick-insects, 617, 621
- Stigma (*Euglena*), 70
- Stigmata, 593*, 607, 627, 640
- Stinging capsule—See Nematocyst
- Stolon, 194*
- Stomach—See Digestive system
- Stomatogastric system, 437
- Stomatopoda**, 555*, 577, 578, 581
- Stomidia, 199*
- Stomodæal canal, 212*
- Stomodæum, 172*, 210
- Stone-canal, 376*, 377, 391
- Stony-corals, 129, 193, 199
- Stratioidrilus tasmanicus*, 331, 332
- Strepsiptera**, 625, 636
- Streptoneura**, 713*, 715, 717, 720, 722, 724, 725, 727, 728, 729, 735
- Streptophiuræ**, 403*
- Strobila, 243*, 256

- Strongylocentrotus*, 386, **387**, **389**, 406—
See Sea-urchin
Strongylostoma, **602**
Strongylus, 300
Stylarioides, 477
Stylaster, 158, **159**
Style, 159*
Stylonychia, 100
Subcortical cavity of sponges, 120*
Sub-cuticle, 299*
Subdermal cavity of sponges, **119***
Sub-genital pit (*Aurelia*), 169*
Sub-genital portico, 182*
Sub-kingdom—See Phylum
Sub-mentum, 605
Sub-radius, 139*
Sub-tentacular canal, 399
Sub-umbrella, 135*
Succession of Life in time, 7
Sucker (*Sepia*), 739*
Sucking-disc, 408
Suctorial mouths, 182*
Summer eggs, 582
Supplemental skeleton, **54**, 56*
Supporting lamella—See Mesogloea
Swimming-bell—See Nectocalyx
Swimming ovaries, 309
Swimming-plate, 210*
Sycantha, 114
Sycetta, 114
Syeetidae, 114*
SYCON: External characters, 106,
107; Microscopic structure, **108**,
109, **110**; Systematic position, 114 :
Development, 124, 125, **126**
Sycon gelatinosum, 117, 118
Sycon raphanus, **126**
Sycon-type of sponge, **118**, 119*
Syllida, 486, 487
Syllis ramosa, **476**
Symbiosis, 65*
Symmetry, **42***, 43: Polype and
Medusa, 138: *Tealia*, 188, 190
Symphyla, **598**, 599*, 600, 602, 661
Synapta, 414, 425, 428
Synapticula, 203*
Synaptida, 420
Syncarida, 552*, 567
Syn-cerebrum, 542*, 615
Syncoryne, **145**
Syncrypta, **73**
Syncytial ectoderm, 293*
Syncytium, 26*, 293*
Syngnatha, 600*, 601, 602
- T
- T**ABANUS, **623**, **629**
Tabule, 157*, 202
Tactile cones, 253*, 263
Tactile organs, 39
Tænia cænurus, 277
Tænia crassicollis, 280
Tænia cucumerina, 264
Tæniada, 250
Tænia echinococcus, 256, **257**, **277**, 278,
281
Tænia mediocanellata, 281
Tænia saginata, 281
Tænia serialis, 277
Tænia serrata, 280
TÆNIA SOLIUM, **243**, 281: General
features, **242**, **243**, 244: Nervous
system, 244: Excretory organs, 244,
245: Reproductive organs, **245**, **246**:
Development, 246, **247**: Systematic
position, 250
Tæniole, 172*
Talitrus, 569
Tanaidacea, 553*, 569, 570, 587
Tanais, 553, 569
Tape-worm—See Tænia and Cestoda
Tardigrada, 657, **658**, 659*, 661, 662
TEALIA: External characters, **184**,
185: Enteric system, 185, **186**:
Cell layers, 186, 187: Muscular
system, **184**, 187, 188: Symmetry,
188: Microscopic structure, **188**,
189: Nervous system, 190: Repro-
ductive organs, 190: Development,
190, **191**: Systematic position, 194
Tealida, 194*
Tectibranchia, 714*, 736
Teloblast, 453*
Telolecithal egg, 217*
Telotrochal larvæ, 474*
Telson, 528*
Temnocephala, 253, **255**, 264, **273**, **274**
Temnocephalea, 249*, 253, **255**, **256**,
264, 267, **273**, **274**, 279, 283
Tendon, 38*
Tentacle roots, 155*
Tentacle sheath, 208*
Tentacles, 33*, 93
Tentacular canal, 212
Tentaculifera, 93*: Body and ten-
tacles, 101, **102**: Nucleus, contractile
vacuoles, shell, colonies, reproduc-
tion, 101, **102**, 103
Tentaculocyst, 155*, 172
Tentorium, 610*
Terebella, **462**
Terebellida, 461, **462**
Terebra, **718**
Terebratulida, **358**, 359, **360**
Terebratulida, 359*
Terebratulina, **365**
Teredo, 678, 682, **683**
Terga, 563*
Tergum, 528*
Termites, 617
Tessera, 176, **177**
Testis—See Spermium
Tethys, 715

- Tetrabranchiata**, 767*, 769, 770, 771, 773, 774, 780
- Tetractinellida**, 113*, 122
- Tetramita*, 73
- Tetrarhynchus*, 256, 257
- Tetrastemma*, 286
- Thalassima*, 479, 481
- Thalassoplaneta*, 63
- Theca*, 202*
- Thomson, J. Vaughan, 3
- Thorax, of *Apus*, 519; *Astacus*, 528; *Periplaneta*, 606; Solpugida, 648
- Thread-worms, 292—See *Nemathelminths*
- Thuricola*, 97
- Thysanopoda*, 554
- Thysanoptera**, 618*
- Thysanozoon*, 251
- Thysanura**, 615*, 625
- Ticks, 637, 646—See *Acarida*
- Tiedemann's vesicles, 377*, 417
- Tintinnidium*, 96
- Tissues, 25*
- Tjalffella*, 221, 222, 223, 226
- Tomopteris*, 477
- Tooth-shells, 663—See *Scaphopoda*
- Tracheae, 36*, 593, 724
- Tracheal gills, 627, 628
- Tracheal system (*Porpita*), 165
- Tracheliastes*, 561*
- Trachelius*, 96
- Trachelomonas*, 73
- Trachylinae**, 142*: General structure, 154; Sense organs, 154; Tentacles, 155; Reproductive organs, 154, 155; Development, 155
- Trachymedusae**, 142*, 154, 155, 156
- Translation, 280*
- Transverse plane, 210*
- Trap-door Spider, 656
- Trapezia*, 207
- Trematoda**, 248*, 252, 253, 254, 255, 256, 258, 259, 260, 261, 262, 263, 264, 265, 266, 267, 268, 272, 273, 274, 278, 279, 280, 282, 283; Example, 236
- Treptoplax*, 231
- Triarthrus becki*, 590
- Trichina*, 305, 306
- Trichinella*, 301, 305, 306
- Trichinella spiralis*, 303
- Trichiniasis, 306
- Trichocyst, 91*, 92
- Trichoplax*, 231
- Trichostomata**, 93
- Tricladida**, 248*, 249, 251, 253, 257, 259, 262, 264, 266, 271, 278, 279
- Tricosphaerium sieboldii*, 50, 51
- Tridacna gigas*, 692
- Trigger-hair—See *Cnidocil*
- Trigonia*, 678, 683, 692
- Trilobita**, 589, 590, 591, 660
- Trimorphism, 130*
- Trimyaria*, 286
- Tristichocteta*, 313
- TRITON RUBICUNDUS**, 702; Shell, 702, 703, 704; External features of soft parts, 704, 705; Foot, 705, 706; Visceral spiral, 706; Mantle, 706; Ctenidium, 706; Osphradium, 706; Digestive system, 707, 708, 709; Vascular system, 709, 710, 711; Excretory system, 711; Nervous system, 710, 711, 712; Sensory organs, 712; Reproductive organs, 712, 713; Systematic position, 715
- Tritonida*, 715*, 725
- Trivium, 370*, 407
- Trochal disc, 318*
- Trochelminthez**, 316*: Appendix, 330
- Trocheta*, 504
- Trochophore—See *Trochosphere*
- Trochosphaera*, 322, 325, 326, 328
- Trochosphaerida**, 322*
- Trochosphere, 316, 430
- Trochus*, 714, 727
- Trombidium fuliginosum*, 649
- Trophozoite, 82
- Trypanosomes*, 72, 74
- Tube-feet, 369, 370*, 387, 388, 393
- Tubifex*, 461, 471
- Tubificidae*, 476
- Tubipora*, 193, 195, 196, 197, 200, 201, 205, 208
- Tubularia*, 145, 153
- Tubulariæ*, 143, 145
- Turbellaria**, 248*, 251, 252, 253, 257, 259, 260, 261, 262, 263, 264, 265, 266, 278, 282; Example, 233
- Turbo*, 714, 727
- Tympanic nerve-endings, 630*
- Tympanum, 630*
- Typhlosol-, 447*, 464, 668

U

- ULMARIÆ**, 176*
- Umbo, 664, 665
- Umbrella, 169*
- Uncus, 319*
- Undulating membrane, 74*, 94, 95, 96
- Unicellular animals, 20*
- Unicellular gland, 26*
- Unio*, 662, 678—See *Anodonta*
- Unio margaritifera*, 662, 692
- Unionidæ*, 678*
- Unisexual, 40*
- Urea, 37
- Uric acid, 13, 37
- Urinary bladder, 671*
- Urinary organs, 37*
- Urnatella*, 347, 348
- Urns, 487*
- Urocæles, 671*
- Uropods, 530*
- Uterine bell, 309
- Uterus, 40*

V

VACUOLE, contractile, **10**, **12***, **13**, **14**,
46, **47**, **47**, **68**, **70**, **79**, **80**, **91**, **95**, **102** :
 non-contractile, **11***, **62**, **95**, **96**

Valenciennes, organ of, **759***

Valvata, **402***

Valvate pedicellariæ, **380***

Van der Hoeven, organ of, **758***

Variation, individual, **2***, **114**, **439**

Variety, **2***, **115***

Vascular system, **35** : Nemertinea.

286, **287** : Acanthocephala, **308** :

Phoronis, **350** : *Magellania*, **358** :

Brachiopoda, **362** : Starfish, **372** :

Antedon, **400** : Echinodermata, **417** :

Holothurian, **418** : *Nereis*, **434** :

Lumbricus, **448** : *Sipunculus*, **487** :

Sipunculoidea, **489** : Archi-annelida.

492 : *Hirudo*, **500** : Hirudinea, **505** :

Apus, **521** : *Astacus*, **539** : Crus-

tacea, **581** : *Peripatus*, **592** : *Peri-*

planeta, **609** : Insects, **627**, **628** :

Scorpio, **641**, **642** : Arachnida, **652** :

Mussel, **672**, **673** : Pelecypoda, **688** :

Amphineura, **698** : *Triton*, **709**, **710** :

Gastropoda, **725** : Scaphopoda, **736** :

Sepia, **744** : *Nautilus*, **761**, **763** :

Cephalopoda, **773**, **774**

Vas deferens—See Spermiduct

Vegetal pole, **731**

Velarium, **169***, **179**

Velata, **402***

Vevela, **165**

Veliger, **691**, **692***, **731**, **734**

Velum, **136***, **137**, **169**, **692**, **732**

Ventral plate, **601***

Ventral surface, **43***

Ventricle, **37***

Venus gnidia, **681**

Venus's Flower-basket, **122**

Venus's Girdle, **220**

Vermes, **233**

Vermetes, **714**

Vermetus, **734**, **735**

Vermiform embryos, **229**

Vertebral column, **4**

Vertical plane, **210***

Vestibule, **97***

Vibracula, **342**, **345***

Vibratile corpuscles, **392**

Virgula, **166***

Visceral spiral, of *Triton*, **706**

Vitellaria, **265**

Vitelline or yolk glands, **233***, **265**

Vitelline membrane, **214**

Vitreous body, **523***

Viviparous animals, **40***

Volva, **730**

Volvox, **74**, **78**, **79**

Vortex, **260**

Vorticella, **94**, **95**, **96**, **97**, **98**, **99**

Vulsella, **680**

W

WALDHEIMIA.—See *Magellania*

Wallace's line, **9***

Wandering cells, **112**

Wasps, **621**, **632**, **637**

Water-bugs, **619**

Water-flea, **514**, **551**

Water-pores, **399***, **417**

Water-sac, **523**

Water-tubes, **399***, **417**, **669**, **670**

Water-vascular system, **232***, **233**

Whale-louse, **571**

Wheel-animalecules—See Rotifera

Wheel-organ, **318**

Whelks, **663**, **714**

White body, **750**

White substance of Schwann, **30***

Winter eggs, **321**, **582**

Wood-louse, **514**, **554**—See *Oniscus*

X

Xiphosura, **646***, **650**, **651**, **652**, **653**,
656, **660**, **661**, **662**

Y

YELLOW CELLS—See *Zooxanthella*

Yellow elastic cartilage, **28***

Yollia, **677**

Yolk, **20***, **21**

Yolk-epithelium, **776***

Yolk or vitelline glands, **233***, **265**

Yolk reservoir, **240**

Yolk-sac, **778**, **779***

Yungia, **271**

Z

ZEPPELINIA, **492**

Zilla callophylla, **654**

Zoea, **584***, **585**

Zoantharia, **192***, **194**, **198**, **224**

Zoanthus, **194**, **195**, **197**, **199**

Zoecium, **334***

Zoo-geographical regions, **8**, **9**

Zooid, **41***, **51**, **76**, **77**, **78**, **278**

Zoology, **1***

Zoophyte, **129**

Zoothamnium, **99**

Zooxanthella, **62**, **65**

Zygophiuræ, **403***

Zygote, **50***, **76**, **78**, **79***, **82**, **83***

